

# Fast-Acting Glass Fuses

For 1/4" x 1 1/4" (6.3mm x 32mm)

AGC

AGC-V



**Catalog Symbol:** AGC (3AG)

**Fast-Acting**

**\*Agency Approvals:** U.L./CSA 248-14

**Construction:** Glass Tube  
Nickel-Plated Brass Endcaps

### Dimensional Data

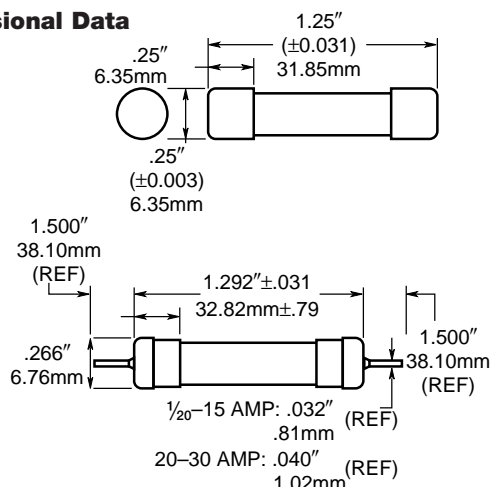

### Electrical Characteristics

Rated Current	Rated Voltage		Interrupting Rating <sup>1</sup>		Pre-arcing I <sup>2</sup> t (A <sup>2</sup> Sec)		Typical Total Clearing <sup>3</sup> I <sup>2</sup> t (A <sup>2</sup> Sec)		Typical Voltage Drop <sup>2</sup> Volts at 100% Rated Current	Agency* Approvals		
	AC (Max.)	DC <sup>6</sup> (Max.)	AC	DC <sup>6</sup>	AC	DC <sup>6</sup>	AC	DC <sup>6</sup>		UL	ULR	CSA
1/20	250V	250V	35A	35A	2.60 × 10 <sup>-4</sup>	4.09	6.50 × 10 <sup>-4</sup>	7.94	.67	•	•	•
1/16	250V	250V	35A	35A	2.40 × 10 <sup>-4</sup>	7.60 × 10 <sup>-5</sup>	3.40 × 10 <sup>-4</sup>	2.12 × 10 <sup>-4</sup>	10.41	•	•	•
1/10	250V	250V	35A	35A	5.50 × 10 <sup>-4</sup>	4.77 × 10 <sup>-4</sup>	1.01 × 10 <sup>-3</sup>	1.27 × 10 <sup>-3</sup>	6.00	•	•	•
1/8	250V	250V	35A	35A	.003	.002	.69	.003	4.67	•	•	•
3/16	250V	250V	35A	35A	.008	.007	.84	.011	4.12	•	•	•
2/10	250V	250V	35A	35A	.011	.008	.74	.013	4.51	•	•	•
1/4	250V	250V	35A	35A	.015	.014	.38	.049	.89	•	•	•
3/10	250V	250V	35A	35A	.044	.040	1.57	.051	2.88	•	•	•
3/8	250V	250V	35A	35A	.091	.072	2.59	.118	4.59	•	•	•
4 3/100	250V	250V	35A	35A	.12	.09	2.78	.267	2.67	•	•	•
1/2	250V	250V	35A	35A	.28	.24	2.75	1.41	.59	•	•	•
3/4	250V	250V	35A	35A	.82	.80	3.69	1.49	.37	•	•	•
1	250V	250V	35A	35A	1.50	1.44	5.21	2.87	.31	•	•	•
1 1/4	250V	250V	100A	100A	1.95	2.14	10.69	9.66	.35	•	•	•
1 1/2	250V	250V	100A	100A	3.44	3.80	16.41	19.08	.27	•	•	•
2	250V	250V	100A	100A	5.4	—	22.14	—	.28	•	•	•
2 1/4	250V	250V	100A	100A	6.0	5.93	19.04	15.70	.26	•	•	•
2 1/2	250V	250V	100A	100A	5.3	7.36	19.70	14.67	.31	•	•	•
3	250V	250V	100A	100A	12.19	13.25	27.29	24.07	.25	•	•	•
4	250V	250V	200A	200A	25.08	27.57	74.91	51.20	.22	•	•	•
5	250V	250V	200A	200A	7.08	7.19	39.80	22.70	.23	•	•	•
6	250V	250V	200A	200A	10.52	11.60	59.49	30.60	.23	•	•	•
7	250V	250V	200A	200A	13.27	14.20	67.68	42.30	.23	•	•	•
8	250V	250V	200A	200A	24.56	25.59	104.90	55.81	.19	•	•	•
9	250V	250V	200A	200A	211.00	205.33	238.40	274.00	.18	•	•	•
10	250V	250V	200A	200A	240.30	268.00	315.70	322.00	.20	•	•	•
15	32V	32V	1000A	1000A	577.00	—	691.00	—	.14	•	•	•
20	32V	32V	1000A	1000A	1241.00	—	1450.00	—	.12	•	•	•
25	32V	32V	1000A	1000A	2276.00	—	2588.00	—	.11	•	•	•
30	32V	32V	1000A	1000A	3812.00	—	4098.00	—	.12	•	•	•

\*Approvals: U.L. Listed, Std. 248-14, Guide JDYX, File E19180; CSA Certification, Class 1422-01, File 53787; AGC & AGC-V U.L. Recognized, Guide JDYX2, File E19180.

- Interrupting ratings were measured at 70%-80% power factor on AC, and at a time constant described in U.L. 198L.
- Voltage drop was measured at 25°C ± 3°C ambient temperature at rated current.
- I<sup>2</sup>t was measured at listed interrupting rating and rated voltage.
- Interrupting rating for AGC 1/20-10A @ 125V is 10,000A. Interrupting rating listed corresponds to maximum rated voltage.
- The AGC-10A fuse is self-certified for 32 Vdc at 1000 AIC.
- Other available sizes include: 1/500, 1/200, 1/100, 1/50, 1/25, 15/100, 175/1000, 1/3, 4/10, 6/10, 8/10, 12/10, 13/10, 16/10, 13/4, 18/10, 32/10, 3 1/2, 4 1/2, 6 1/4, 7 1/2, 12 and 14.
- 1-10A, U.L. Recognized for 125 Vdc and 500 AIC. Other DC ratings are self-certified.

CE logo denotes compliance with European Union Low Voltage Directive (50-1000 Vac, 75-1500 Vdc). Refer to BIF document #8002 or contact Bussmann Application Engineering at 636-527-1270 for more information.

### Time-Current Characteristics

Rated Current	Percent of Rating		
	110%	135%	200%
1/20-30	4 hrs. (min)	60 min. (max)	120 sec. (max)

### Packaging & Ordering Information:

Package Code	AGC	V	(See Table)
Blank 5 in	Product Symbol	Lead Blank -no lead	Rated Current
BK/ 100 in		V-Axial lead	

# Fast-Acting Glass Fuses

## For 1/4" x 1 1/4" (6.3mm x 32mm)

**AGC**  
**AGC-V**

### 1.0 Typical Voltage Drop (At 25°C Ambient Temperature)

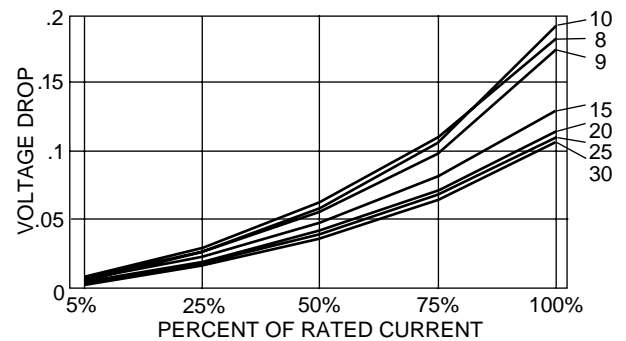
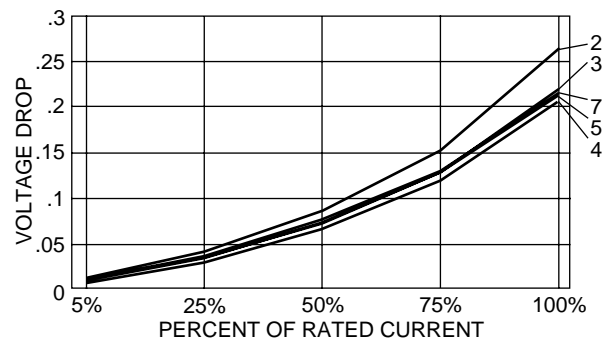
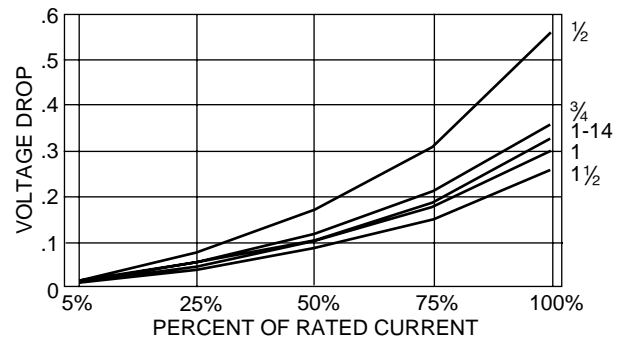
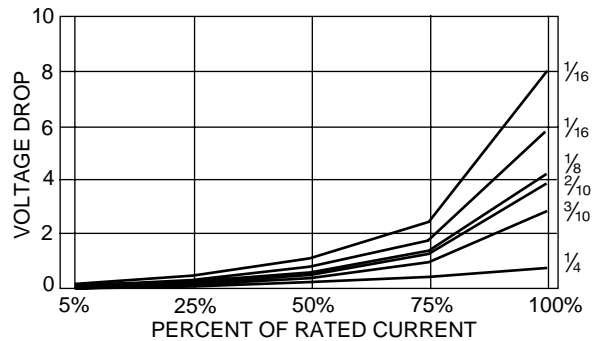

### Time-Current Characteristic Curves—Average Melt (Full Size Curves Available)

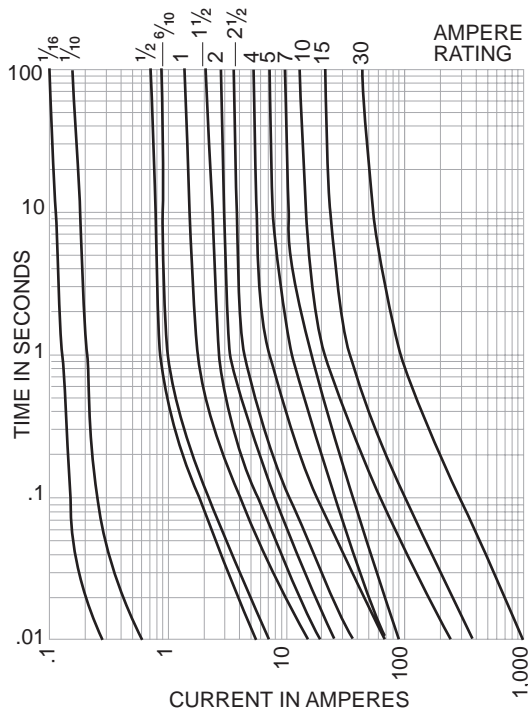

### 2.0 Ambient Temperature Effect Chart (Derating Curve)

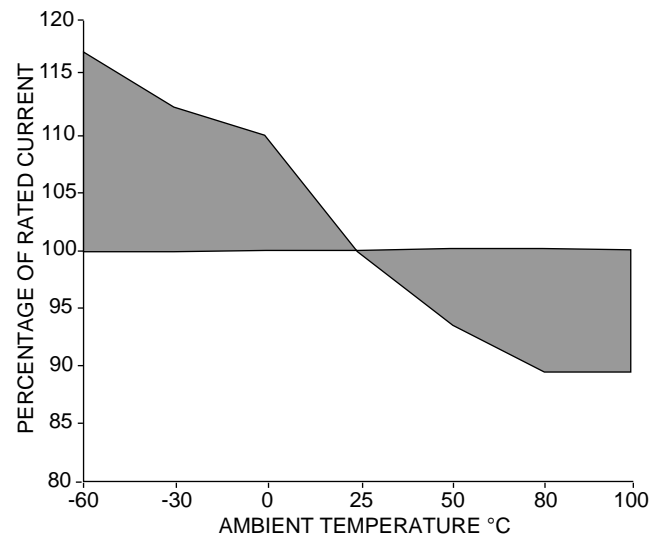

The only controlled copy of this BIF document is the electronic read-only version located on the Bussmann Network Drive. All other copies of this document are by definition uncontrolled. This bulletin is intended to clearly present comprehensive product data and provide technical information that will help the end user with design applications. Bussmann reserves the right, without notice, to change design or construction of any products and to discontinue or limit distribution of any products. Bussmann also reserves the right to change or update, without notice, any technical information contained in this bulletin. Once a product has been selected, it should be tested by the user in all possible applications.