

# SPECIFICATION FOR APPROVAL www.DataSheet4U.com

REF : 20070101-A

PAGE: 1

PROD. NAME	SHIELDED SMD POWER INDUCTOR	ABC'S DWG NO.	SH2011□□□□L□-□□□
		ABC'S ITEM NO.	

**. CONFIGURATION & DIMENSIONS :**

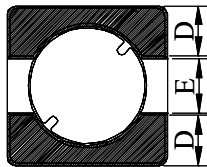
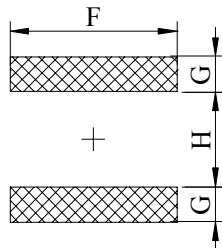
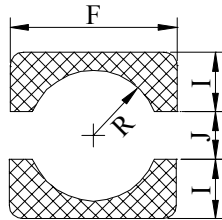
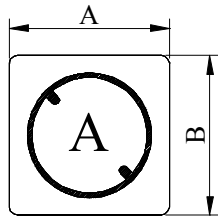

- A : 2.60 ±0.20 m/m
- B : 2.60 ±0.20 m/m
- C : 1.10 ±0.10 m/m
- D : 0.80 typ m/m
- E : 0.90 typ m/m
- F : 2.90 ref m/m
- G : 0.70 ref m/m
- H : 1.70 ref m/m
- I : 1.00 ref m/m
- J : 0.90 ref m/m
- R : 0.90 ref m/m

( PCB Pattern Suggestion )

**. SCHEMATIC DIAGRAM :**

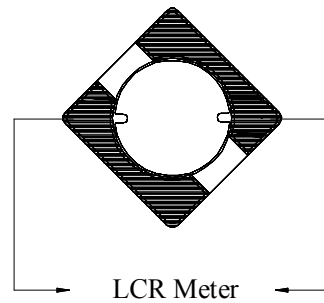

**. MATERIALS :**

- a . Core : Ferrite DR core
- b . Core : Ferrite RI core
- c . Wire : Enamelled copper wire ( Class H )
- d . Adhesive : Epoxy resin
- e . Terminal : Ag/Ni/Sn
- f . Remark : Products comply with RoHS' requirements

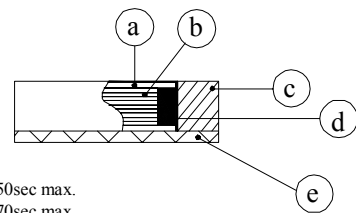

Peak Temp : 260 max.  
 Max time above 230 : 50sec max.  
 Max time above 200 : 70sec max.

**. GENERAL SPECIFICATION :**

- a . Temp. rise : 40 max.
- b . Storage temp. : -40 ----+125
- c . Operating temp. : -40 ----+105
- d . Resistance to solder heat : 260 .10 secs.

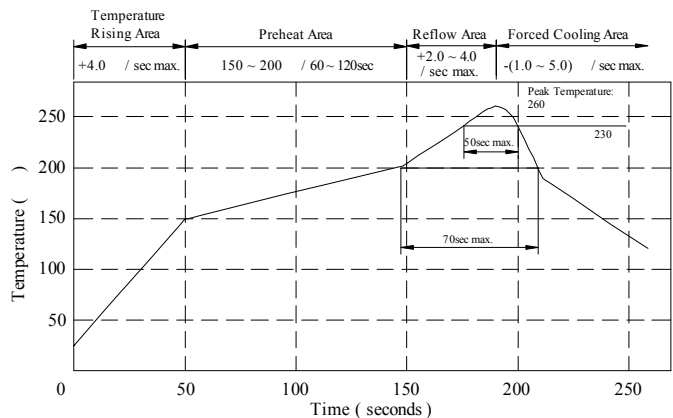

AR-001A



# SPECIFICATION FOR APPROVAL

PROD. NAME	SHIELDED SMD POWER INDUCTOR	ABC'S DWG NO.	SH2011□□□□L□-□□□
		ABC'S ITEM NO.	

**ELECTRICAL CHARACTERISTICS :**

DWG No.	Inductance ( $\mu$ H)	Q ref.	Test Freq. ( MHz )	SRF ( MHz ) typ.	RDC ( m $\Omega$ )		Irms ( mA ) max.	Isat ( mA ) typ.	Marking
					typ.	max.			
SH20111R0YL□ -□□□	1.0 $\pm$ 30 %	6	7.96	190	65	85	1200	850	A
SH20111R5YL□ -□□□	1.5 $\pm$ 30 %	6	7.96	150	105	135	1100	675	C
SH20113R3YL□ -□□□	3.3 $\pm$ 30 %	6	7.96	100	245	320	875	500	E
SH20114R7YL□ -□□□	4.7 $\pm$ 30 %	8	7.96	85	400	520	620	410	F
SH20116R8YL□ -□□□	6.8 $\pm$ 30 %	8	7.96	70	570	740	550	320	G
SH2011100YL□ -□□□	10.0 $\pm$ 30 %	10	2.52	60	910	1185	450	290	H
SH2011150YL□ -□□□	15.0 $\pm$ 30 %	10	2.52	50	1000	1300	375	240	I
SH2011220YL□ -□□□	22.0 $\pm$ 30 %	10	2.52	35	1420	1850	220	190	J

- 1). □ : Packaging Information... [A] : Bulk [B] : Taping Reel
- 2). "-□□□" : Reference code
- 3). Inductance Test Freq. : 100KHz / 0.1V
- 4). Irms base on Temp. rise 40 max.
- 5). Isat base on L / LOA=35% typ.

@ Inductance VS. DC Current Curve

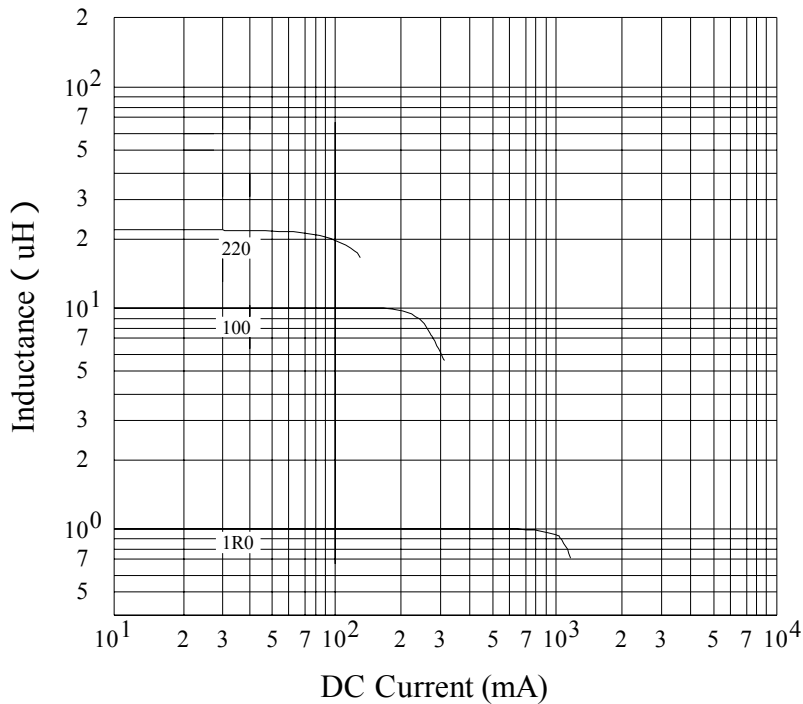

# SPECIFICATION FOR APPROVAL www.DataSheet4U.com

REF : 20070101-A

PAGE: 3

PROD. NAME	SHIELDED SMD POWER INDUCTOR	ABC'S DWG NO.	SH2011□□□□L□-□□□
		ABC'S ITEM NO.	

**PACKAGING INFORMATION :**

( 1 ) Configuration

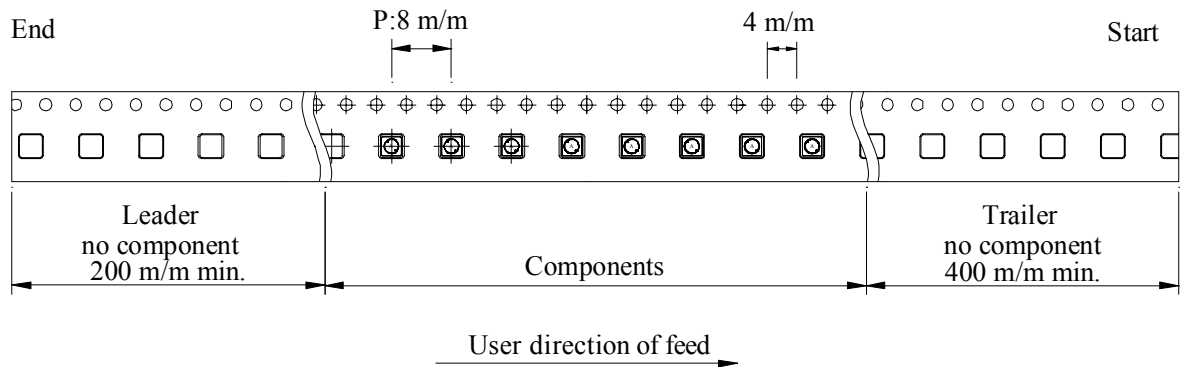
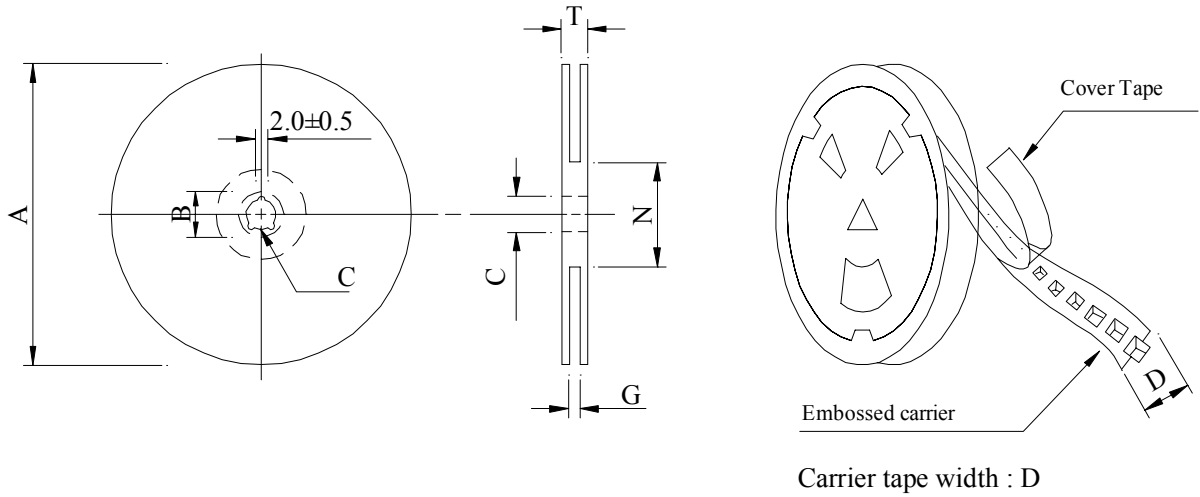

( 2 ) Dimensions

Unit:m/m

Style	A	B	C	D	G	N	T
07 - 12	178	21±0.8	13	12	14 <sup>+0</sup>	50 <sup>-0</sup>	16.5

( 3 ) Q'TY & G.W. Per package

Series	Inner : Reel			Outer : Carton		
	Q'TY (pcs)	G.W. (gw)	Style	Q'TY (pcs)	G.W. (Kg)	Size (cm)
SH2011	1,500	120	07 - 12	60,000	4.8	42 x 41 x 24

AR-001A



# SPECIFICATION FOR APPROVAL www.DataSheet4U.com

REF : 20070101-A

PAGE: 4

PROD. NAME	SHIELDED SMD POWER INDUCTOR	ABC'S DWG NO.	SH2011□□□□L□-□□□
		ABC'S ITEM NO.	

. DWGING NUMBER EXPRESSION :

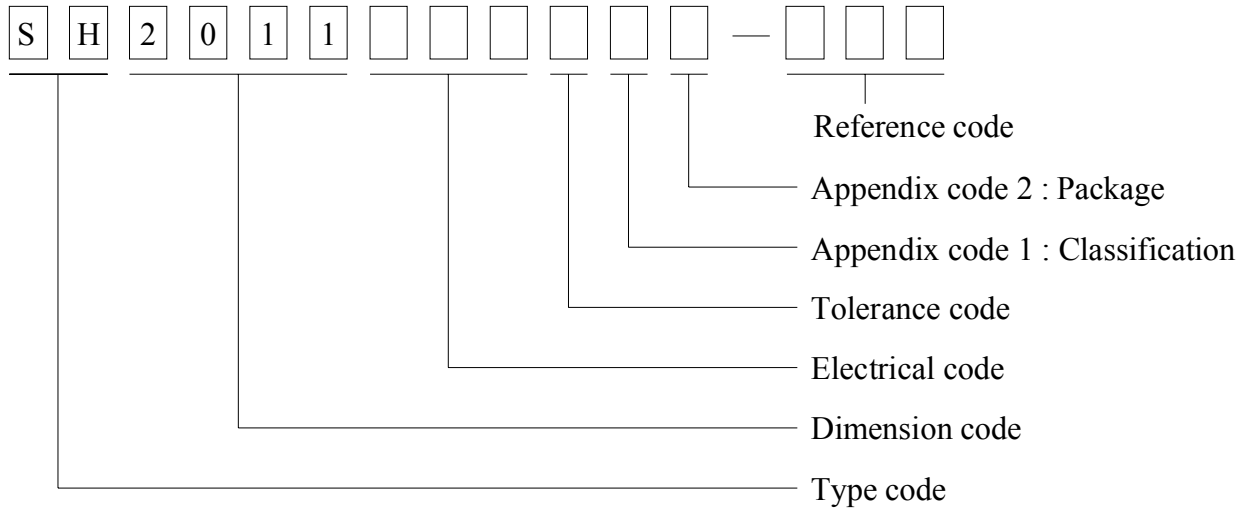

Appendix code 1 : Product Classification

- L : Lead Free Standard products comply with RoHS' requirements
- 1 ~ 9 : Lead Free Special products comply with RoHS' requirements

Appendix code 2 : Package Information

Code	Inner package	Inner package Q'TY	Remark
A	T.B.D.	T.B.D.	
B	T / R ( Reel package )	1,500 pcs	

AR-001A



# SPECIFICATION FOR APPROVAL

www.DataSheet4U.com

REF : 20070101-A

PAGE: 5

PROD. NAME	SHIELDED SMD POWER INDUCTOR	ABC'S DWG NO.	SH2011□□□□L□-□□□
		ABC'S ITEM NO.	

**. RELIABILITY TEST :**

Test item	Specification	Test condition						
Solderability	More than 90% of the terminal electrode shall be covered With fresh solder.	Preheat : 150±25 for 60 seconds Solder : Sn96.5 / Ag3 / Cu0.5 or equivalent Solder temp. : 235±5 Flux : Rosin Dip time : 4±1 seconds						
Thermal shock test ( Temp. cycle )	Inductance shall not change more than ±20%	<table style="width: 100%; border: none;"> <tr> <td style="border: none;">Room temp. 15 minutes</td> <td style="border: none; text-align: center;">→</td> <td style="border: none; text-align: right;">-25±2 30 minutes</td> </tr> <tr> <td style="border: none;">Room temp. 15 minutes</td> <td style="border: none; text-align: center;">→</td> <td style="border: none; text-align: right;">85±2 30 minutes</td> </tr> </table> <p>Total : 50 cycles</p>	Room temp. 15 minutes	→	-25±2 30 minutes	Room temp. 15 minutes	→	85±2 30 minutes
Room temp. 15 minutes	→	-25±2 30 minutes						
Room temp. 15 minutes	→	85±2 30 minutes						
Humidity Resistance test		Temperature : 40±2 Humidity : 90 ~ 95% Applied current : Per spec. Time : 500 hours						
High temp. Resistance test		Temperature : 105±2 Applied current : Per spec. Time : 500 hours						

AR-001A



# SPECIFICATION FOR APPROVAL

PROD. NAME	SHIELDED SMD  POWER INDUCTOR	ABC'S DWG NO.  ABC'S ITEM NO.	SH2011□□□□L□-□□□
---------------	------------------------------------	-------------------------------------	------------------

UL CARD :

OBMW2		August 27, 1999			
Magnet Wire-Component					
ELEKTRISOLA (MALAYSLA) SDN BHD					E143312
IALAN DAMN SATU IANDA BAIK 28750 BENTONG, PAHANG DARUL MAKMUR MALAYSIA					
Mtl Dsg	Mark Dsg	Coating Type		ANSI Typ	Temp Class
		BC	OC		
Estersol 160	E180	Polyesterimide (solderable)	---	MW-77	180
Amldester 200	A200	Polyesterimide	---	MW-74	200
Polysol-N 155	PN155	Polyurethane	Nylon	MW-80, MW-28	155, 100
Polysol 155	P155	Polyurethane	---	MW-79, MW-79	155, 130
Polysol 155g	Pg155	Polyurethane	---	MW-79	130
Polysol 155p	Pp155,Gp155	Polyurethane	---	MW-79	155
Polysol 160	P160	Polyurethane	---	MW-79	155
Polysol 180	P180	Polyurethane	---	MW-79	155
Polysol 170	P170 or G170	Polyurethane	---	MW-79	156
Polysol-N 180	PN180	Polyurethane	Nylon	---	180

Marking : Company name/material designation or marked designation and factory identification on package ok reel

---

See General Information preceding These Recognitions  
For use only in equipment where the acceptability of the combination is determined by Underwriters Laboratories Inc.