

**PLEASE CHECK WWW.MOLEX.COM FOR LATEST PART INFORMATION**

**Part Number:** [0050362379](#)  
**Status:** **Active**  
**Overview:** [minifit\\_jr](#)  
**Description:** 4.20mm (.165") Pitch Mini-Fit Jr.™ Header, Dual Row, Right Angle, with PCB Mousing Peg, 6 Circuits, PA Polyamide Nylon 6/6, 94V-2, Matte Tin (Sn)

**Documents:**

[3D Model](#) [Product Specification PS-5556-001 \(PDF\)](#)  
[Drawing \(PDF\)](#) [RoHS Certificate of Compliance \(PDF\)](#)

**Agency Certification**

CSA	LR19980
TUV	R72081037
UL	E29179

**General**

Product Family	PCB Headers
Series	<a href="#">5569</a>
Application	Wire-to-Board
Comments	Current = 13A max. per circuit when header is mated to a receptacle loaded with <a href="#">45750</a> Mini-Fit Plus HCS™ Crimp Terminal Crimped to to 16 AWG wire. . See Molex Product specification PS-5556-001 for additional current de-rating information.

Overview [minifit\\_jr](#)  
Product Name Mini-Fit Jr.™

**Physical**

Breakaway	No
Circuits (Loaded)	6
Circuits (maximum)	6
Circuits Detail	6
Color - Resin	Natural
Durability (mating cycles max)	30
First Mate / Last Break	No
Flammability	94V-2
Glow-Wire Compliant	No
Guide to Mating Part	No
Keying to Mating Part	None
Lock to Mating Part	Yes
Material - Metal	Brass
Material - Plating Mating	Tin
Material - Plating Termination	Nickel
Material - Resin	Nylon
Number of Rows	2
Orientation	Right Angle
PC Tail Length (in)	0.142 In
PC Tail Length (mm)	3.60 mm
PCB Locator	Yes
PCB Retention	Yes
PCB Thickness Recommended (in)	0.070 In
PCB Thickness Recommended (mm)	1.78 mm
Packaging Type	Bag
Pitch - Mating Interface (in)	0.165 In
Pitch - Mating Interface (mm)	4.20 mm
Pitch - Term. Interface (in)	0.165 In

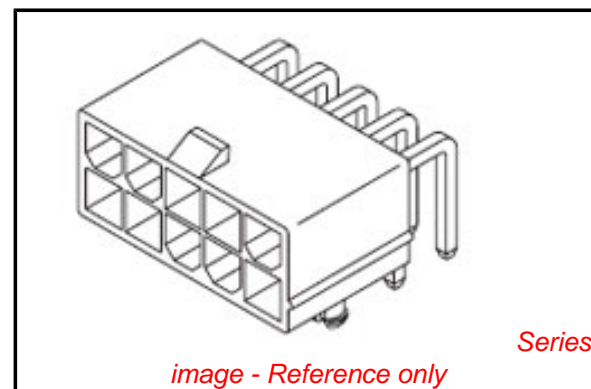

**EU RoHS**

**ELV and RoHS Compliant**  
**REACH SVHC Contains SVHC: No**  
**Halogen-Free Status**  
**Not Reviewed**

**China RoHS**



**Need more information on product environmental compliance?**

Email [productcompliance@molex.com](mailto:productcompliance@molex.com)  
For a multiple part number RoHS Certificate of Compliance, [click here](#)

Please visit the [Contact Us](#) section for any non-product compliance questions.

**Search Parts in this Series**

[5569Series](#)

**Mates With**

[5557](#) Mini-Fit Jr.™ Receptacle Housing

Pitch - Term. Interface (mm)	4.20 mm
Polarized to Mating Part	Yes
Polarized to PCB	Yes
Shrouded	Fully
Stackable	No
Surface Mount Compatible (SMC)	No
Temperature Range - Operating	-40°C to +105°C
Termination Interface: Style	Through Hole

### **Electrical**

Current - Maximum per Contact	13A
Voltage - Maximum	600V

### **Solder Process Data**

Duration at Max. Process Temperature (seconds)	5
Lead-free Process Capability	Wave Capable (TH only)
Max. Cycles at Max. Process Temperature	1
Process Temperature max. C	260

### **Material Info**

Old Part Number	5569-06A1MS-210
-----------------	-----------------

### **Reference - Drawing Numbers**

Packaging Specification	PK-5569-002
Product Specification	PS-5556-001
Sales Drawing	SD-5569-222

This document was generated on 05/21/2010

**PLEASE CHECK [WWW.MOLEX.COM](http://WWW.MOLEX.COM) FOR LATEST PART INFORMATION**

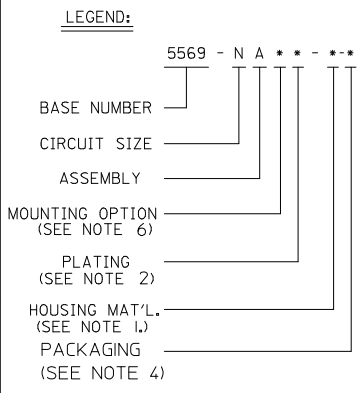

CIRCUIT SIZE	DIM. "A"	DIM. "B"
6	.54 (13.8)	.33 (8.4)
8	.71 (18.0)	.50 (12.6)
10	.87 (22.2)	.66 (16.8)
12	1.04 (26.4)	.83 (21.0)
14	1.20 (30.6)	.99 (25.2)
16	1.37 (34.8)	1.16 (29.4)
18	1.54 (39.0)	1.32 (33.6)
20	1.70 (43.2)	1.49 (37.8)
22	1.87 (47.4)	1.65 (42.0)
24	2.03 (51.6)	1.82 (46.2)

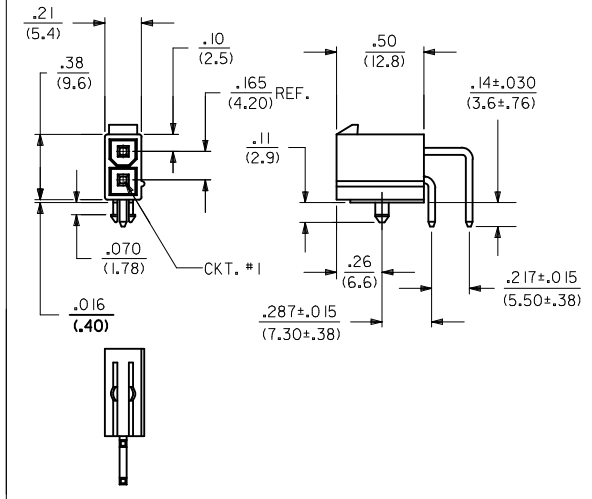
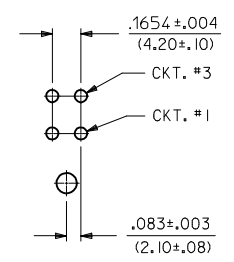
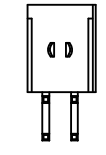
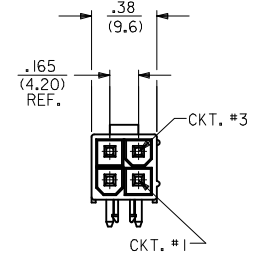
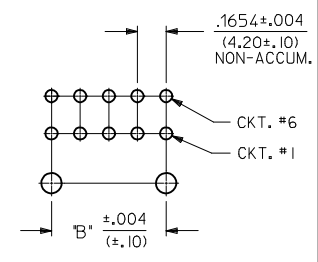
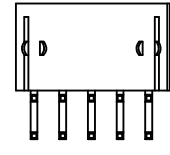
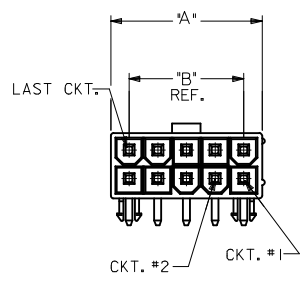

5569-02A2\*-\*

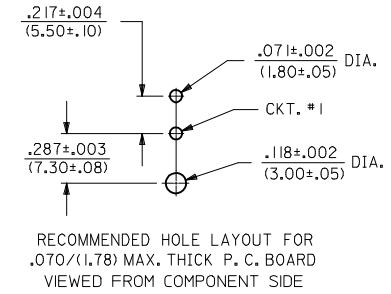

**NOTES:**

- TERMINAL MATERIAL: BRASS ALLOY  
HOUSING MATERIAL:  
"BLANK" = NYLON (PA66), UNFILLED, UL94V-2 COLOR: NATURAL.  
"100" = NYLON (PA66), UNFILLED, UL94V-2 COLOR: BLACK.  
"BL" = NYLON (PA66), UNFILLED, UL94V-2 COLOR: BLACK  
"210" = NYLON (PA66), UNFILLED, UL94V-0 COLOR: NATURAL.  
"400" = NYLON (PA66), UNFILLED, UL94V-0 COLOR: BLACK.
- TERMINAL PLATING:  
MS - .000100/(.00254) MIN. MATTE TIN OVER  
.000050/(.00127) MIN. NICKEL OVERALL.
- PRODUCT SPECIFICATION: PS-5556-001
- PACKAGING:  
BLANK = BULK PACKED PER PK-5569-002  
T = TRAY PACKED PER PK-5569-003
- PART MATES WITH MINI-FIT JR. RECEPTACLE #5557.
- MOUNTING OPTIONS:  
1 - SCREW MOUNT (SEE \*SD-5569-NA\*1 SERIES DWGS.)  
(OR SHEET 3 FOR MATTE TIN IN SCREW MOUNT)  
2 - PEG MOUNT
- DISCOLORATION IN THE BANDOLIER CARRIER AREA OF THE PIN IS INHERENT TO THE PLATING PROCESS AND IS DUE TO THE MASKING EFFECT OF THE CARRIER. THIS DISCOLORATION IS IN A NON-FUNCTIONAL AREA OF THE PIN AND WILL NOT AFFECT THE PERFORMANCE OF THE HEADER ASSEMBLY.
- PARTS ARE NOT DESIGNED FOR CURRENT SHARING
- CONNECTORS ARE NOT TO BE MATED OR UNMATED WHILE CIRCUITS ARE LIVE.
- PART CONFORMS TO CLASS "B" REQUIREMENTS OF COSMETIC SPECIFICATION PS-45499-002.

SEE SHEETS 3 AND 4 FOR FLANGE MOUNT OPTION

<b>ADD FLANGE MTG</b> EC NO: UCP2009-1190 DRWNG: JALOSTEINER 2008/11/11 CHKD: JEBEL 2008/11/13 APPR: F.S.MITH 2008/11/14	QUALITY SYMBOLS ▽=0 ▽=0	GENERAL TOLERANCES (UNLESS SPECIFIED) <table border="1"> <thead> <tr> <th></th> <th>mm</th> <th>INCH</th> </tr> </thead> <tbody> <tr> <td>4 PLACES ±</td> <td>---</td> <td>---</td> </tr> <tr> <td>3 PLACES ±</td> <td>---</td> <td>±.010</td> </tr> <tr> <td>2 PLACES ±</td> <td>.25</td> <td>±.015</td> </tr> <tr> <td>1 PLACE ±</td> <td>.38</td> <td>---</td> </tr> </tbody> </table>		mm	INCH	4 PLACES ±	---	---	3 PLACES ±	---	±.010	2 PLACES ±	.25	±.015	1 PLACE ±	.38	---	DIMENSION STYLE <b>IN/MM</b>	SCALE <b>1:1</b>	DESIGN UNITS <b>METRIC</b>	THIRD ANGLE PROJECTION
			mm	INCH																	
4 PLACES ±	---	---																			
3 PLACES ±	---	±.010																			
2 PLACES ±	.25	±.015																			
1 PLACE ±	.38	---																			
DRAFT WHERE APPLICABLE MUST REMAIN WITHIN DIMENSIONS	MATERIAL NO. <b>SEE CHART</b>	DRAWN BY AD RATNOL DATE 2006/01/17	CHECKED BY GPOLGAR DATE 2006/01/17	APPROVED BY JCOMERC I DATE 2006/01/17	TITLE <b>MINI-FIT JR RIGHT ANGLE HEADER ASSYS W/ MATTE SN W/ MNTG PEGS OR FLANGES</b>	MOLEX INCORPORATED															
<b>A3</b>	REV	SIZE <b>C</b>	DOCUMENT NO. <b>SD-5569-222</b>	SHEET NO. <b>1 OF 4</b>																	

4	A3
3	A3
2	A3
1	A3
	SHEET REV

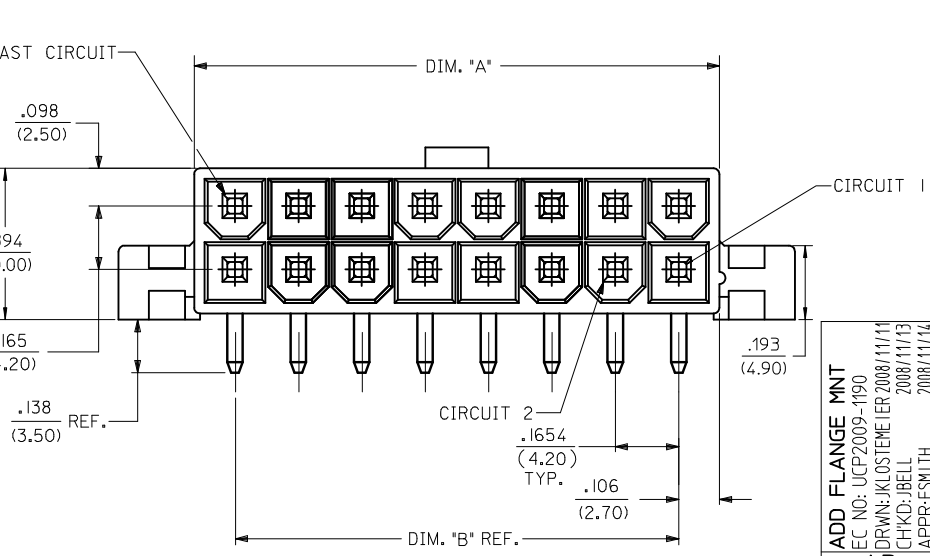
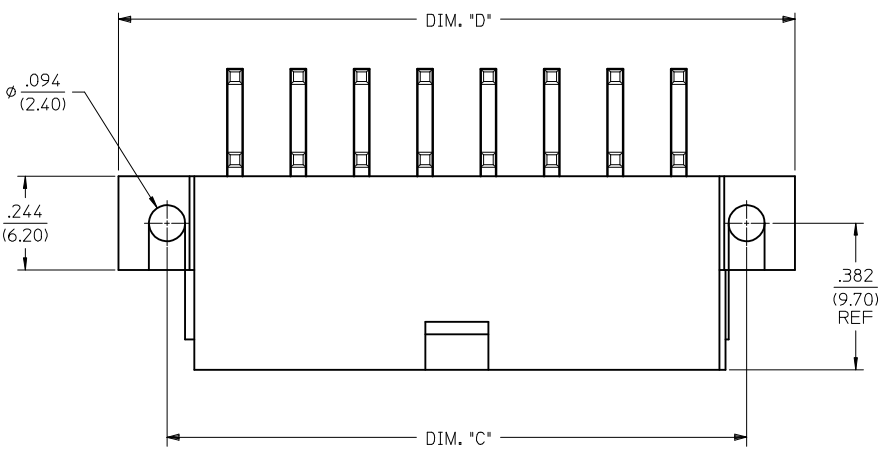
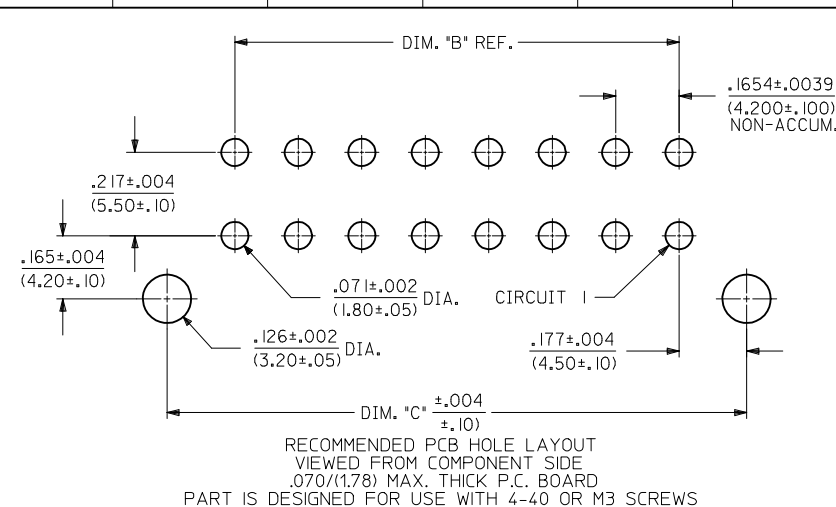

CIRCUIT SIZE	DIM. "A"	DIM. "B"	DIM. "C"	DIM. "D"
2	.213 (5.40)	—	.354 (9.00)	.606 (15.40)
4	.378 (9.60)	.165 (4.20)	.520 (13.20)	.772 (19.60)
6	.543 (13.80)	.331 (8.40)	.685 (17.40)	.937 (23.80)
8	.709 (18.00)	.496 (12.60)	.850 (21.60)	1.102 (28.00)
10	.874 (22.20)	.661 (16.80)	1.016 (25.80)	1.268 (32.20)
12	1.039 (26.40)	.827 (21.00)	1.181 (30.00)	1.433 (36.40)
14	1.205 (30.60)	.992 (25.20)	1.346 (34.20)	1.598 (40.60)
16	1.370 (34.80)	1.157 (29.40)	1.512 (38.40)	1.764 (44.80)
18	1.535 (39.00)	1.323 (33.60)	1.677 (42.60)	1.929 (49.00)
20	1.701 (43.20)	1.488 (37.80)	1.843 (46.80)	2.094 (53.20)
22	1.866 (47.40)	1.654 (42.00)	2.008 (51.00)	2.260 (57.40)
24	2.031 (51.60)	1.819 (46.20)	2.173 (55.20)	2.425 (61.60)

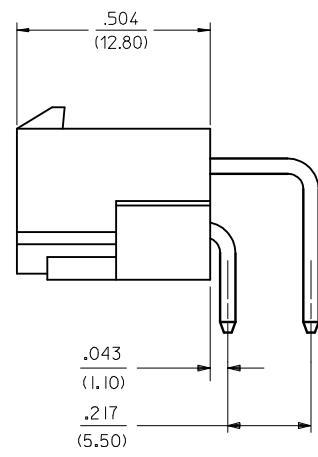

SEE SHEET 1 AND 2 FOR PEG MOUNT OPTION

<b>ADD FLANGE MNT</b> EC NO: UCP2009-1190 DRWN:KLOSTERMEIER 2008/11/11 CHKD:JBELL 2008/11/13 APPR:FSMITH 2008/11/14	QUALITY SYMBOLS ▽=0 ▽=0	GENERAL TOLERANCES (UNLESS SPECIFIED) mm INCH 4 PLACES ± --- ± --- 3 PLACES ± --- ± .015 2 PLACES ± 0.38 ± --- 1 PLACE ± --- ± --- ANGULAR ±1/2°	DIMENSION STYLE IN/MM DRAWN BY DATE R/JF 3/27/92 CHECKED BY DATE R/JF 3/27/92 APPROVED BY DATE RAS 3/27/92	SCALE 1:1 DESIGN UNITS METRIC THIRD ANGLE PROJECTION	TITLE MINI-FIT JR. RT ANGLE HEADER ASSY W/ MATTE SN W/ MNTG PEGS OR FLANGES
	MATERIAL NO. SEE CHARTS DOCUMENT NO. SD-5569-222			SHEET NO. 3 OF 4	
	DRAFT WHERE APPLICABLE MUST REMAIN WITHIN DIMENSIONS				
	THIS DRAWING CONTAINS INFORMATION THAT IS PROPRIETARY TO MOLEX INCORPORATED AND SHOULD NOT BE USED WITHOUT WRITTEN PERMISSION				

PART NUMBER	ENGINEERING NUMBER	CKT SIZE	MOUNTING OPTION	PLATING (NOTE 6)	HOUSING MATERIAL
50-36-2384	5569-02A1MS	02	FLANGE	MATTE TIN OVER NICKEL	94V-2
50-36-2385	5569-04A1MS	04	↑	↑	↑
50-36-2382	5569-06A1MS	06	↑	↑	↑
50-36-2383	5569-08A1MS	08	↑	↑	↑
50-36-2386	5569-10A1MS	10	↑	↑	↑
50-36-2387	5569-12A1MS	12	↑	↑	↑
50-36-2388	5569-14A1MS	14	↑	↑	↑
50-36-2389	5569-16A1MS	16	↑	↑	↑
50-36-2391	5569-18A1MS	18	↑	↑	↑
50-36-2411	5569-20A1MS	20	↑	↑	↑
50-36-2412	5569-22A1MS	22	↓	↓	↓
50-36-2413	5569-24A1MS	24	FLANGE	MATTE TIN OVER NICKEL	94V-2

PART NUMBER	ENGINEERING NUMBER	CKT SIZE	MOUNTING OPTION	PLATING (NOTE 6)	HOUSING MATERIAL
50-36-2414	5569-02A1MS-210	02	FLANGE	MATTE TIN OVER NICKEL	94V-0
50-36-2415	5569-04A1MS-210	04	↑	↑	↑
50-36-2379	5569-06A1MS-210	06	↑	↑	↑
50-36-2381	5569-08A1MS-210	08	↑	↑	↑
50-36-2416	5569-10A1MS-210	10	↑	↑	↑
50-36-2417	5569-12A1MS-210	12	↑	↑	↑
50-36-2418	5569-14A1MS-210	14	↑	↑	↑
50-36-2419	5569-16A1MS-210	16	↑	↑	↑
50-36-2421	5569-18A1MS-210	18	↑	↑	↑
50-36-2422	5569-20A1MS-210	20	↑	↑	↑
50-36-2423	5569-22A1MS-210	22	↓	↓	↓
50-36-2424	5569-24A1MS-210	24	FLANGE	MATTE TIN OVER NICKEL	94V-0

PART NUMBER	ENGINEERING NUMBER	CKT SIZE	MOUNTING OPTION	PLATING (NOTE 6)	HOUSING MATERIAL
		02			
		04			
		06			
		08			
		10			
		12			
		14			
		16			
		18			
		20			
		22			
		24			

PART NUMBER	ENGINEERING NUMBER	CKT SIZE	MOUNTING OPTION	PLATING (NOTE 6)	HOUSING MATERIAL
		02			
		04			
		06			
		08			
		10			
		12			
		14			
		16			
		18			
		20			
		22			
		24			

PART NUMBER	ENGINEERING NUMBER	CKT SIZE	MOUNTING OPTION	PLATING (NOTE 6)	HOUSING MATERIAL
		02			
		04			
		06			
		08			
		10			
		12			
		14			
		16			
		18			
		20			
		22			
		24			

PART NUMBER	ENGINEERING NUMBER	CKT SIZE	MOUNTING OPTION	PLATING (NOTE 6)	HOUSING MATERIAL
		02			
		04			
		06			
		08			
		10			
		12			
		14			
		16			
		18			
		20			
		22			
		24			

SEE SHEETS 1 AND 2 FOR PEG MOUNT OPTION

<b>ADD FLANGE MNT</b> EC NO: UCP2005-1190 DRWN:JKLOSTERNER 2008/11/11 CHKD:JBELL 2008/11/13 APPR:FSMITH 2008/11/14 REV DESCRIPTION	QUALITY SYMBOLS	GENERAL TOLERANCES (UNLESS SPECIFIED) <table border="1"> <tr><th></th><th>mm</th><th>INCH</th></tr> <tr><td>4 PLACES</td><td>± ---</td><td>± ---</td></tr> <tr><td>3 PLACES</td><td>± ---</td><td>± ---</td></tr> <tr><td>2 PLACES</td><td>± ---</td><td>± ---</td></tr> <tr><td>1 PLACE</td><td>± ---</td><td>± ---</td></tr> </table>		mm	INCH	4 PLACES	± ---	± ---	3 PLACES	± ---	± ---	2 PLACES	± ---	± ---	1 PLACE	± ---	± ---	DIMENSION STYLE	SCALE	DESIGN UNITS	THIRD ANGLE PROJECTION
			mm	INCH																	
	4 PLACES	± ---	± ---																		
	3 PLACES	± ---	± ---																		
2 PLACES	± ---	± ---																			
1 PLACE	± ---	± ---																			
▼=0 ▽=0	IN/MM 1:1 METRIC	DRAWN BY DATE ADRATNOL 2006/01/17 CHECKED BY DATE GPOLGAR 2006/01/17 APPROVED BY DATE JCOMERC I 2006/01/17	TITLE	MINI-FIT JR. RIGHT ANGLE HEADER ASSYS W/ MATTE SN W/ MNTG PEGS OR FLANGES																	
	ANGULAR ± ---° DRAFT WHERE APPLICABLE MUST REMAIN WITHIN DIMENSIONS	MATERIAL NO. <b>SEE CHART</b>	MOLEX INCORPORATED DOCUMENT NO. <b>SD-5569-222</b>	SHEET NO. <b>4 OF 4</b>																	
		SIZE THIS DRAWING CONTAINS INFORMATION THAT IS PROPRIETARY TO MOLEX INCORPORATED AND SHOULD NOT BE USED WITHOUT WRITTEN PERMISSION																			