

FEATURES

- Oscillation frequency is set by two external resistors
- Ultra low distortion: 0.0018% typical
- Stable
- Hybrid, small

GENERAL DESCRIPTION

ROJ-20 and ROJ-1K are resistor tuneable oscillators whose oscillation frequency is set with two external resistors. Output frequency range of ROJ-20 is 20Hz to 20KHz while that of ROJ-1K is 1KHz to 100KHz. Output distortion is as low as 0.0018% typical at 1KHz frequency range. Output voltage temperature coefficient is also as low as 50ppm/°C. Output voltage amplitude is internally trimmed at 2.5Vrms ±0.5% and this amplitude is adjusted to the range from 500mV to 20Vp-p with external resistors. Sine and cosine waves are generated from two output terminals. A synchronization input terminal is provided in order to fine tune the relationship of these two outputs.

Hybrid construction has made it possible to build highly stable oscillators in small size at low cost.

MECHANICAL DIMENSIONS INCHES (mm)

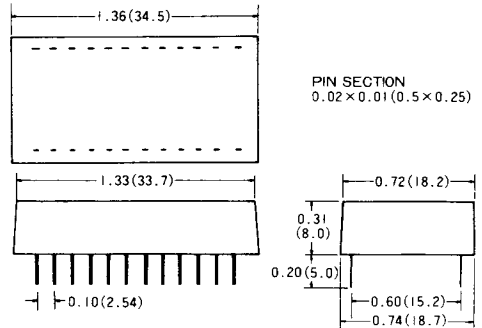

PHASE DIFFERENCE BETWEEN SYNC INPUT AND OUTPUT (Fig. 6) (Technical Note 5)

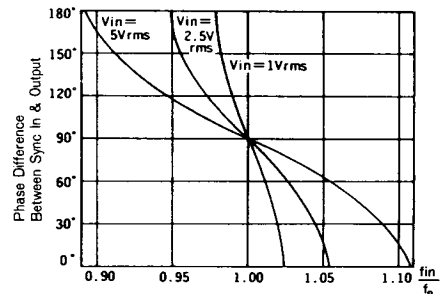

f_{in} : Sync Input Frequency
 f_o : Frequency when no Sync In is given.

PIN CONNECTIONS

PIN	FUNCTION
1	SYNCHRONIZATION INPUT
3	GND
5	-15V POWER SUPPLY
7	+15V POWER SUPPLY
11	OUTPUT 1
12	20Vp-p
14	20Vp-p
16	REXT
18	OUTPUT 2 (-90°)
19	REXT
20	GND
21	REXT

DO NOT CONNECT UNUSED PINS

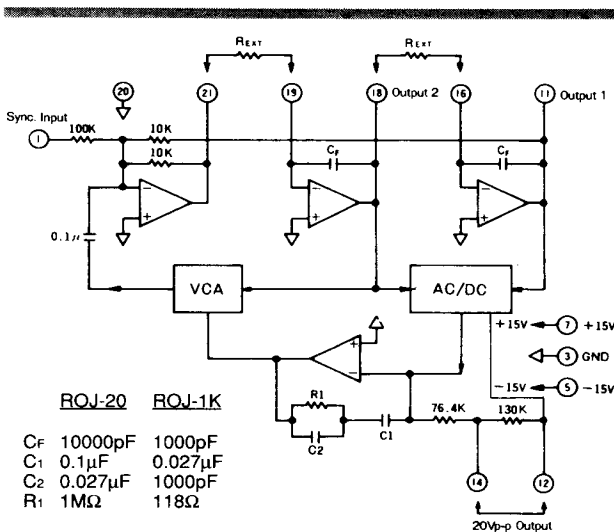

SPECIFICATIONS

Typical value at 25°C with ±15VDC supplies unless otherwise specified.

	ROJ-20	ROJ-1K
OSCILLATED FREQUENCY		
Frequency Range (Note 1)	20Hz - 20KHz	1KHz - 100KHz
Accuracy, Calculated Frequency	0.5% @ 1KHz	0.5% @ 10KHz
Wave Shape	Sin, Cosin	* Same as left
OUTPUT CHARACTERISTICS		
Output Voltage/Current	±10V/5mA	*
Voltage Level Accuracy (Note 2)	2.5Vrms ±0.5% max.	*
" (20Vp-p, Note 3)	0.05% (<10KHz)	0.1% (<50KHz)
Distortion	0.0018% typ (>70 Hz)	*
	0.005% max.	* (2KHz - 50KHz)
	(70Hz - 10KHz)	0.01% max. (>50KHz)
Output Impedance	50 ohm max.	*
Load	2 Kohm min. 100pF max.	*
Voltage Level Tracking Error	0.4% (Rext1=Rext2)	*
Output Voltage TC	50ppm/°C	*
Frequency TC	15ppm/°C	25ppm/°C
POWER REQUIREMENTS & ENVIRONMENT		
Power Supply Voltage	±15V±10%	*
Power Supply Current	+14mA, -21mA	*
Operating Temperature Range	-20°C to +70°C	*
Storage Temperature Range	-30°C to +80°C	*
Relative Humidity	10% to 95% Non Condensing	*

Note 1. Two external resistors are:
 ROJ-20 $R_{ext} = \frac{15.9}{f_o \text{ (KHz)}} \text{ (Kohm)}$
 ROJ-1K $R_{ext} = \frac{159}{f_o \text{ (KHz)}} \text{ (Kohm)}$

Note 2. Pins 12 and 14 OPEN.
 Note 3. Pins 12 and 14 CONNECTED.

OUTPUT LEVEL ADJUSTMENTS

Figures 4 and 5
 (Technical Note 2)

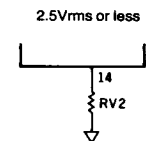

Figure 4a.

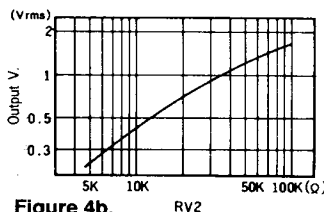

Figure 4b.

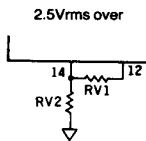

Figure 5a.

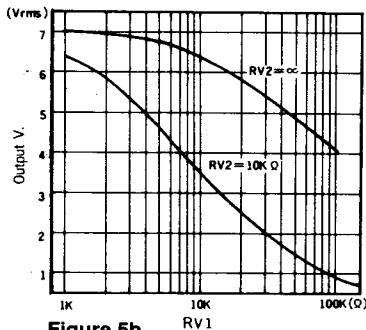
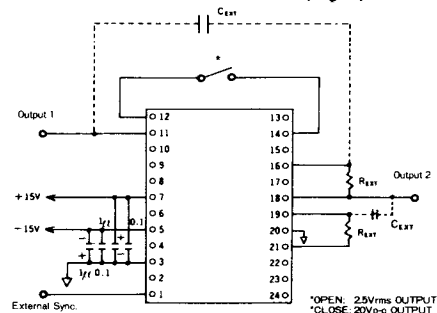

Figure 5b.

TYPICAL CONNECTIONS (Fig. 3)



TECHNICAL NOTES

- Typical connections are shown in Figure 3. Do not connect unused pins to any points. The external synchronization pin (Pin 1) is left open normally.
- Output voltage level is 20Vp-p when the pins 12 and 14 are connected, 2.5Vrms when these pins are disconnected.

Any output voltage level can be set using external resistors RV1 and RV2 as shown Figure 4-a and 5-a.

The curves 4-b and 5-b show approximate values. The use of potentiometers are recommended when an accurate level of output is desired.

- Output frequency can be slightly shifted toward lower frequency range if two Cext are added. See Figure 3. Relationship among Rext, Cext and fo are:

$$\text{ROJ-20 } R_{ext} = \frac{159}{(C_{ext} + 0.01) \times f_o} \text{ (Kohm)}$$

$$C_{ext} : \mu\text{F } f_o : \text{Hz}$$

$$\text{ROJ-1K } R_{ext} = \frac{159}{(C_{ext} + 0.001) \times f_o} \text{ (Kohm)}$$

- Output frequency could become unstable if the capacitive load exceeds 100pF. The use of 50ohm resistor or an output buffer amplifier is recommended.

- Output frequency can be synchronized with the input from the pin 1. First, oscillate at nearly equal frequency to the one desired to be synchronized. Then, apply synchronization frequency to pin 1 at several Vrms level.

Phase difference between synchronization input and output frequency vs. the frequency ratio is shown in Figure 6.

ORDERING INFORMATION

MODEL	DESCRIPTION
ROJ-20	20 Hz to 20 KHz output
ROJ-1K	1 KHz to 100 KHz output