HA12163 Series

Audio Signal Processor for Car Deck and Cassette Deck
(Dolby B-type NR with PB Amp)

HITACHI

ADE-207-059C (Z)

4th Edition
Jun. 1999

Description

HA12163 series are silicon monolithic bipolar IC providing Dolby noise reduction system*, music sensor and PB equalizer system in one chip.

Functions

- PB equalizer × 2 channel
- Dolby B-NR × 2 channel
- Music sensor × 1 channel

Features

- Different type of PB equalizer characteristics selection (normal/chrome or metal) is available with fully electronic control switching built-in.
- 2 type of input selection (radio/tape) is available.
- Changeable to forward, reverse-mode for PB head with fully electronic control switching built-in.
- Available to change music sensing level by external resistor.
- Music sensing level selection is available with fully electronic control switching built-in.
- Available to change frequency response of music sensor.
- NR-on/off and REC/PB fully electronic control switching built-in.
- 4 type of PB-out level.
- Available to allow common PCB designs with HA12173 series.

* Dolby is a trademark of Dolby Laboratories Licensing Corporation.
A license from Dolby Laboratories Licensing Corporation is required for the use of this IC.

HA12163 Series

Ordering Information

	PB-OUT level	Dolby level	REC-OUT level	Unit	Package
HA12163	300	300	300	mVrms	FP-56
HA12166F					FP-48
HA12164	450	300	300	mVrms	FP-56
HA12165	580	300	300	mVrms	FP-56
HA12160	550	300	300	mVrms	FP-56

- Notes: 1. PB-OUT level above shown is typical value when adjusting Dolby level at Rec-out with NR-off mode.
2. HA12166F is only changes by package from HA12163. It is the same electrical characteristics that HA12163.

Absolute Maximum Ratings

Item	Symbol	Ratings	Unit
Supply voltage	V_{cc} max	16	V
Power dissipation* ¹	Pd	400* ²	mW
Operating temperature	Topr	-40 to +85	°C
Storage temperature	Tstg	-55 to +125	°C

- Notes: 1. Value at $T_a \leq 85^\circ\text{C}$
2. HA12166F = 360 mW

Operating Voltage Range

Type	Min	Max	Unit
HA12163, HA12166F	6.5	16	V
HA12164	7.2	16	V
HA12165	8.5	16	V
HA12160	8.2	16	V

- Note: 1. The minimum operating voltage of HA12163 series are different from the HA12173 series (Dolby B/C-type).

Block Diagram (HA12163/164/165/160)

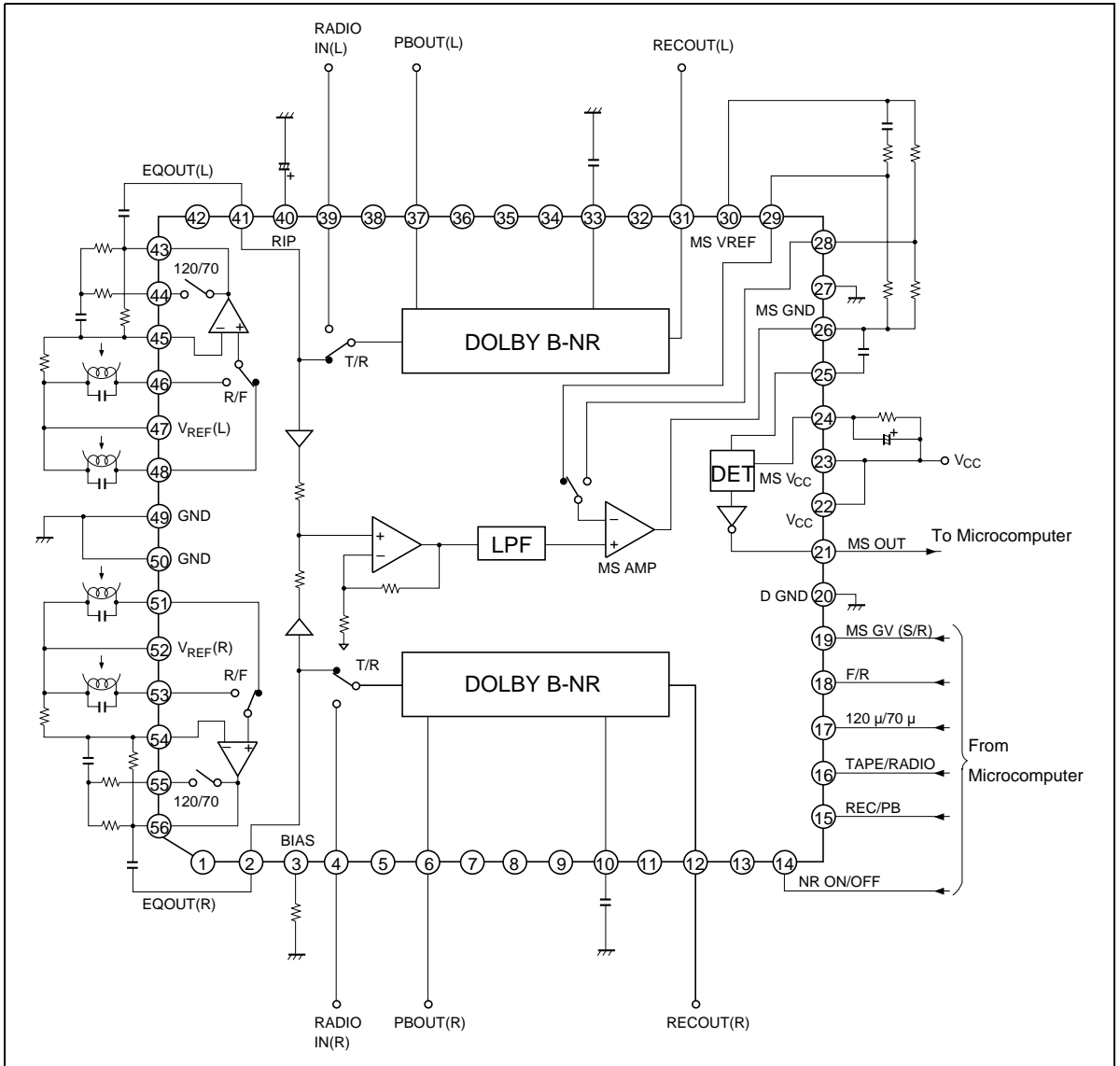

HA12163 Series

Block Diagram (HA12166F)

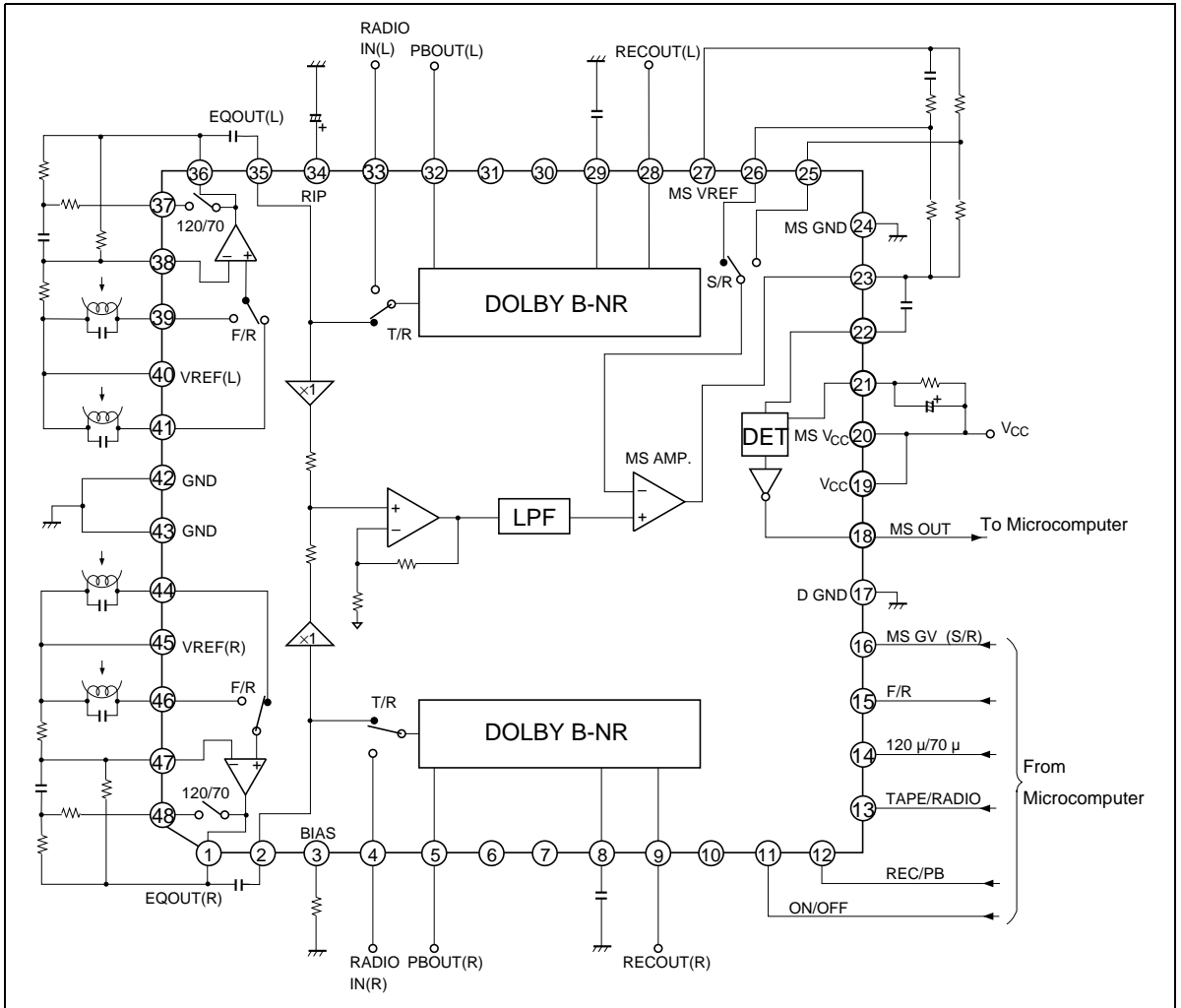

Electrical Characteristics (Ta = 25°C Dolby level 300 mVrms (Rec-out pin))

HA12163, HA12166F V_{cc} = 9.0 V HA12164 V_{cc} = 9.0 V

HA12165 V_{cc} = 12 V HA12160 V_{cc} = 9.0 V

Item	Symbol	Min	Typ	Max	Unit	Test conditions	Note
Quiescent current	I _Q	6.0	11.0	17.0	mA	No input	No Signal NR-ON, 70 μ
Input amp gain	HA12163	GvIA TAI	18.5	20.0	21.5	dB	Vin = 0 dB, f = 1 kHz
	HA12166F	GvIA RAI	15.5	17.0	18.5		
	HA12164	GvIA TAI	22.0	23.5	25.0		Vin = 0 dB, f = 1 kHz
		GvIA RAI	19.0	20.5	22.0		
	HA12165	GvIA TAI	24.2	25.7	27.2		Vin = 0 dB, f = 1 kHz
		GvIA RAI	21.2	22.7	24.2		
	HA12160	GvIA TAI	23.7	25.2	26.7		Vin = 0 dB, f = 1 kHz
		GvIA RAI	20.7	22.2	23.7		
B-type encode	ENC -2k (1)	2.8	4.3	5.8	dB	Vin = -20 dB, f = 2 kHz	
Boost	ENC -2k (2)	7.0	8.5	10.0		Vin = -30 dB, f = 2 kHz	
	ENC -5k (1)	1.7	3.2	4.7		Vin = -20 dB, f = 5 kHz	
	ENC -5k (2)	6.7	8.2	9.7		Vin = -30 dB, f = 5 kHz	
	Signal handling	Vo max	12.0	13.0	—	dB	THD = 1%, f = 1 kHz *1
Signal to noise ratio	S/N	64.0	70.0	—	dB	Rg = 5.1 kΩ, CCIR/ARM	
THD	THD	—	0.05	0.3	%	Vin = 0 dB, f = 1 kHz	
Channel separation	CT RL (1)	70.0	85.0	—	dB	Vin = 0 dB, f = 1 kHz	RAI input
	CT RL (2)	50.0	60.0	—		Vin = 0.6 mVrms, f = 1 kHz	EQ input
Crosstalk	CT EQ → RAI	70.0	80.0	—		Vin = 0 dB, f = 1 kHz	EQ input
	CT RAI → EQ	50.0	60.0	—			RAI input
PB - EQ gain	Gv EQ 1k	37.0	40.0	43.0	dB	Vin = 0.6 mVrms, f = 1 kHz	120 μ
	Gv EQ 10k (1)	33.0	36.0	39.0		Vin = 0.6 mVrms, f = 10 kHz	
	Gv EQ 10k (2)	29.0	32.0	35.0		70 μ	
PB - EQ maximum output	VoM	300	600	—	mVrms	THD = 1%, f = 1 kHz	*1
PB - EQ THD	THD - EQ	—	0.05	0.3	%	Vin = 0.6 mVrms, f = 1 kHz	
Noise voltage level converted in input	V _N	—	0.7	1.5	μVrms	Rg = 680 Ω, DIN - AUDIO	
MS sensing level	V _{ON} (1)	-36.0	-32.0	-28.0	dB	f = 5 kHz, Normal speed	
	V _{ON} (2)	-18.0	-14.0	-10.0		f = 5 kHz, High speed	

HA12163 Series

Electrical Characteristics (Ta = 25°C Dolby level 300 mVrms (Rec-out pin)) (cont)

HA12163, HA12166F $V_{CC} = 9.0\text{ V}$ HA12164 $V_{CC} = 9.0\text{ V}$

HA12165 $V_{CC} = 12\text{ V}$ HA12160 $V_{CC} = 9.0\text{ V}$

Item	Symbol	Min	Typ	Max	Unit	Test conditions	Note
MS output low level	V_{OL}	—	1.0	1.5	V		
MS output leak current	I_{OH}	—	0.0	2.0	μA		
Control voltage	V_{IL}	-0.2	—	1.5	V		
	V_{IH}	3.5	—	5.3			

Note: 1. HA12163 HA12166F $V_{CC} = 6.5\text{ V}$, HA12164 $V_{CC} = 7.2\text{ V}$, HA12165 $V_{CC} = 8.5\text{ V}$, HA12160 $V_{CC} = 8.2\text{ V}$

HA12163 Series

HA12166F

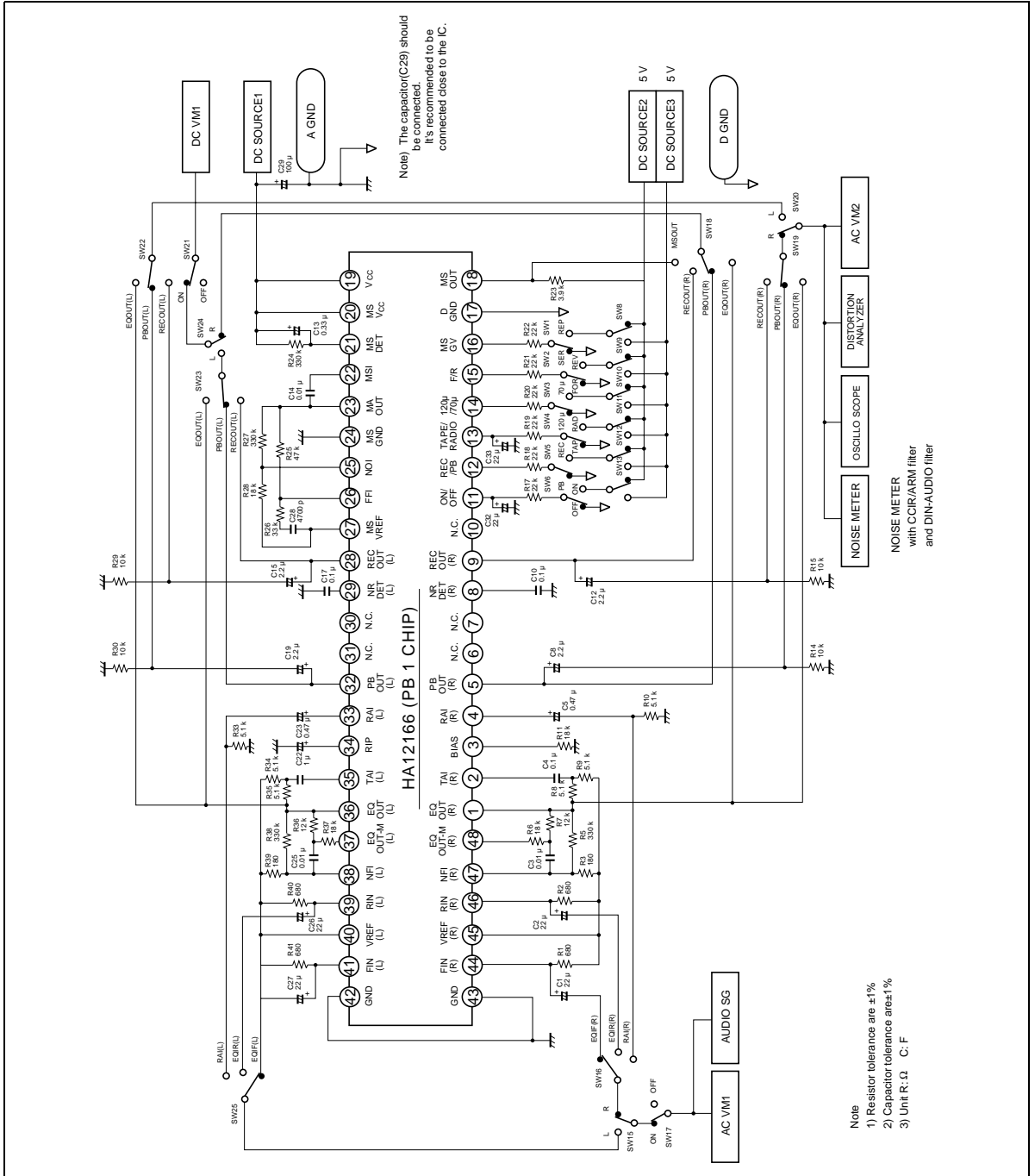

Pin Description ($V_{CC} = 9\text{ V}$ Single supply, $T_a = 25^\circ\text{C}$, No signal, The value in the table show typical value)

Pin No.	Terminal	DC	Description
QFP-48	QFP-56	name	Zin voltage Equivalent circuit
2	2	TAI	100 k Ω $V_{CC}/2$
35	41		
4	4	RAI	
33	39		
22	25	MSI	
8	10	NR DET	— 2.5 V
29	33		
3	3	BIAS	— 0.28 V

HA12163 Series

Pin Description ($V_{CC} = 9\text{ V}$ Single supply, $T_a = 25^\circ\text{C}$, No signal, The value in the table show typical value) (cont)

Pin No.	Terminal	DC	Equivalent circuit		Description
QFP-48	QFP-56	name	Zin	voltage	
21	24	MS DET	—	V_{CC}	Time constant pin for rectifier
16	19	MS GV	100 k Ω	—	Mode control input
34	40	RIP	—	$V_{CC}/2$	Ripple filter

Pin Description ($V_{CC} = 9\text{ V}$ Single supply, $T_a = 25^\circ\text{C}$, No signal, The value in the table show typical value) (cont)

Pin No.	Terminal	DC	Equivalent circuit	Description
1	EQ OUT	—	$V_{CC}/2$	Equalizer output
36				
5	PB OUT			Play back (Decode) output
32				
27	MS V_{REF}			Reference voltage buffer output
23	MA OUT			Music sensor amp output
40	V_{REF}			Reference voltage buffer output
45				
9	REC OUT			Recording (Encode) output
28				

HA12163 Series

Pin Description ($V_{CC} = 9\text{ V}$ Single supply, $T_a = 25^\circ\text{C}$, No signal, The value in the table show typical value) (cont)

Pin No.	Terminal	DC				
QFP-48	QFP-56	name	Zin	voltage	Equivalent circuit	Description
37	44	EQ OUT-M	—	$V_{CC}/2$		Equalizer output (Metal)
48	55					
18	21	MS OUT	—	—		Music sensor output to MPU
19	22	V_{CC}	—	V_{CC}		
20	23	MS V_{CC}				
17	20	D GND	—	0.0 V		Digital (Logic) ground
24	27	MS GND				Music sensor ground
42	49	GND				Ground
43	50					

Pin Description ($V_{CC} = 9\text{ V}$ Single supply, $T_a = 25^\circ\text{C}$, No signal, The value in the table show typical value) (cont)

Pin No.	Terminal	DC				
QFP-48	QFP-56	name	Zin	voltage	Equivalent circuit	Description
41	48	F_{IN}	—	$V_{CC}/2$		PB - EQ
44	51					input for Forward
39	46	R_{IN}				PB - EQ
46	53					input for Reverse
38	45	NFI				Negative
47	54					feedback terminal of PB - EQ amp
25	28	NOI				Negative feedback input for Normal speed
26	29	FFI				Negative feedback input for FF or REW

HA12163 Series

Pin Description ($V_{CC} = 9\text{ V}$ Single supply, $T_a = 25^\circ\text{C}$, No signal, The value in the table show typical value) (cont)

Pin No.	Terminal	DC	Equivalent circuit			Description
QFP-48	QFP-56	name	Zin	voltage		
11	14	ON/OFF	100 k Ω	—	—	Mode control input
12	15	REC/PB				
13	16	TAPE/ RADIO				
14	17	120 μ /70 μ				
15	18	F/R				
6	1	NC	—	—	—	No connection
7	5					
10	7					
30	8					
31	9					
	11					
	13					
	32					
	34					
	35					
	36					
	38					
	42					

Application Note

1. Power Supply Range

HA12163 series are provided with four line output level, which will permit on optimum overload margin for power supply conditions. And this series are designd to operate on single supply only. In case of split supply use, please consult with sales engineer.

Table 1 Supply Voltage

	HA12163	HA12164	HA12165	HA12160
Single supply	6.5 V to 16.0 V	7.2 V to 16.0 V	8.5 V to 16.0 V	8.2 V to 16.0 V

A. The lower limit of supply voltage depends on the line output reference level.

The minimum value of the overload margin is specified as 12 dB by Dolby Laboratories.

B. In the reverse-voltage conditions such as ‘D-GND is higher than V_{CC} ’ or ‘D-GND is lower than GND’, excessive current flows into the D-GND to destory this IC. To prevent such destruction, pay attention to the followings on using.

Short-circuit the D-GND and GND directory on the board mounting this IC.

2. Reference Voltage

These devices provide the reference voltage of half the supply voltage that is the signal grounds. As the peculiarity of these devices, the capacitor for the ripple filter is very small about 1/100 compared with their usual value. The Reference voltage are provided for the left channel and the right channel separately. The block diagram is shown as figure 1.

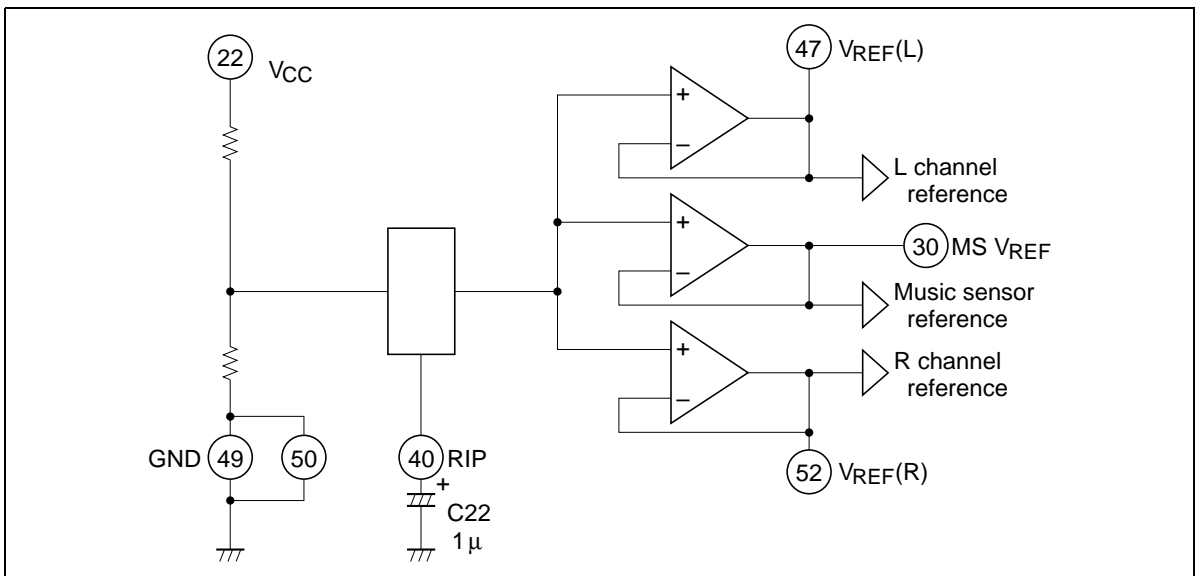

Figure 1 The Block Diagram of Reference Voltage Supply

HA12163 Series

3. Operating Mode Control

HA12163 series provide fully electronic switching circuits. And each operating mode control are controlled by parallel data (DC voltage).

Table 2 Threshold Voltage (V_{TH})

Pin No.	Low	High	Unit	Test conditions
14, 15, 16, 17, 18, 19	-0.2 to 1.5	3.5 to 5.3	V	

Table 3 Switching Truth Table

Pin No.	Low	High
14	NR - OFF	NR - ON
15	PB	REC
16	TAPE	RADIO
17	120 μ (NORMAL)	70 μ (METAL or CHROME)
18	FORWARD	REVERSE
19	SER (FF or REV)	REP (NORMAL SPEED)

- Notes:
1. Each pins are on pulled down with 100 k Ω internal resistor. Therefore, it will be low-level when each pins are open.
 2. Over shoot level and under shoot level of input signal must be the standardized (High: 5.3 V, Low: -0.2 V)
 3. When connecting microcomputer or Logic-IC with HA12163 series directly, there is apprehension of rush-current under some transition timing of raising voltage or falling voltage at V_{cc} ON/OFF. On using, connect protective resistors of 10 to 22 k Ω to all the control pins. It is shown is test circuit on this data sheet. And pins fixed to low level should be preferably open.
 4. Pay attention not to make digital GND voltage lower than GND voltage.

4. Input Block Diagram and Level Diagram

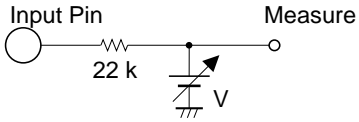
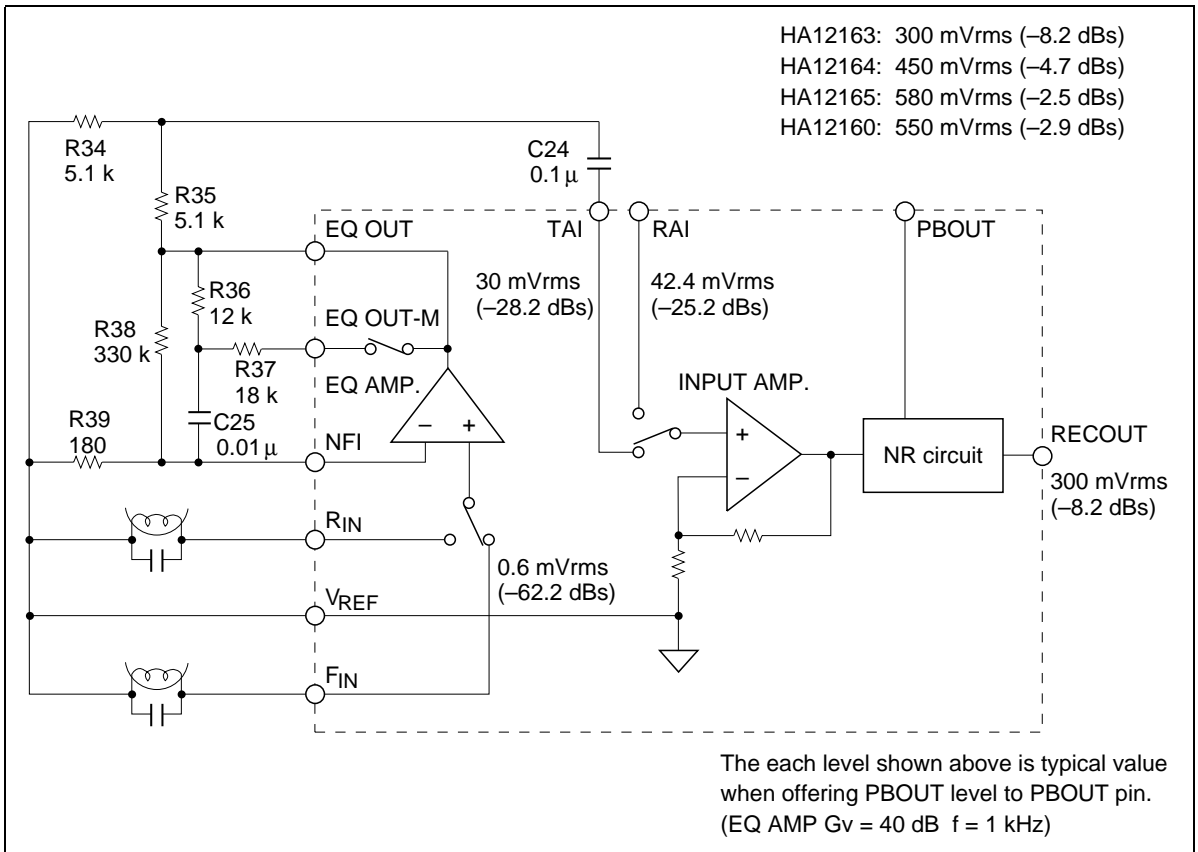

Figure 2 Input Block Diagram

5. Adjustment of Playback Dolby Level

After replace R34 and R35 with a half-fix volume of 10 kΩ, adjust RECOUT level to be Dolby level with playback mode.

HA12163 Series

6. Note on Connecting with Tape Head to IC

This IC has no internal resistor to give the DC bias current to equalizer amp, therefore the DC bias current will give through the head. This IC provides the V_{ref} buffer output pin for Rch and Lch separately (has two V_{ref} terminal). In case of use that the Rch and Lch reference of head are connected commonly, please use one of V_{ref} terminals of IC (47 pin or 52 pin) for head reference. If both 47 pin and 52 pin of IC are connected, rush current give the great damage to IC. The application circuit is shown in figure 3.

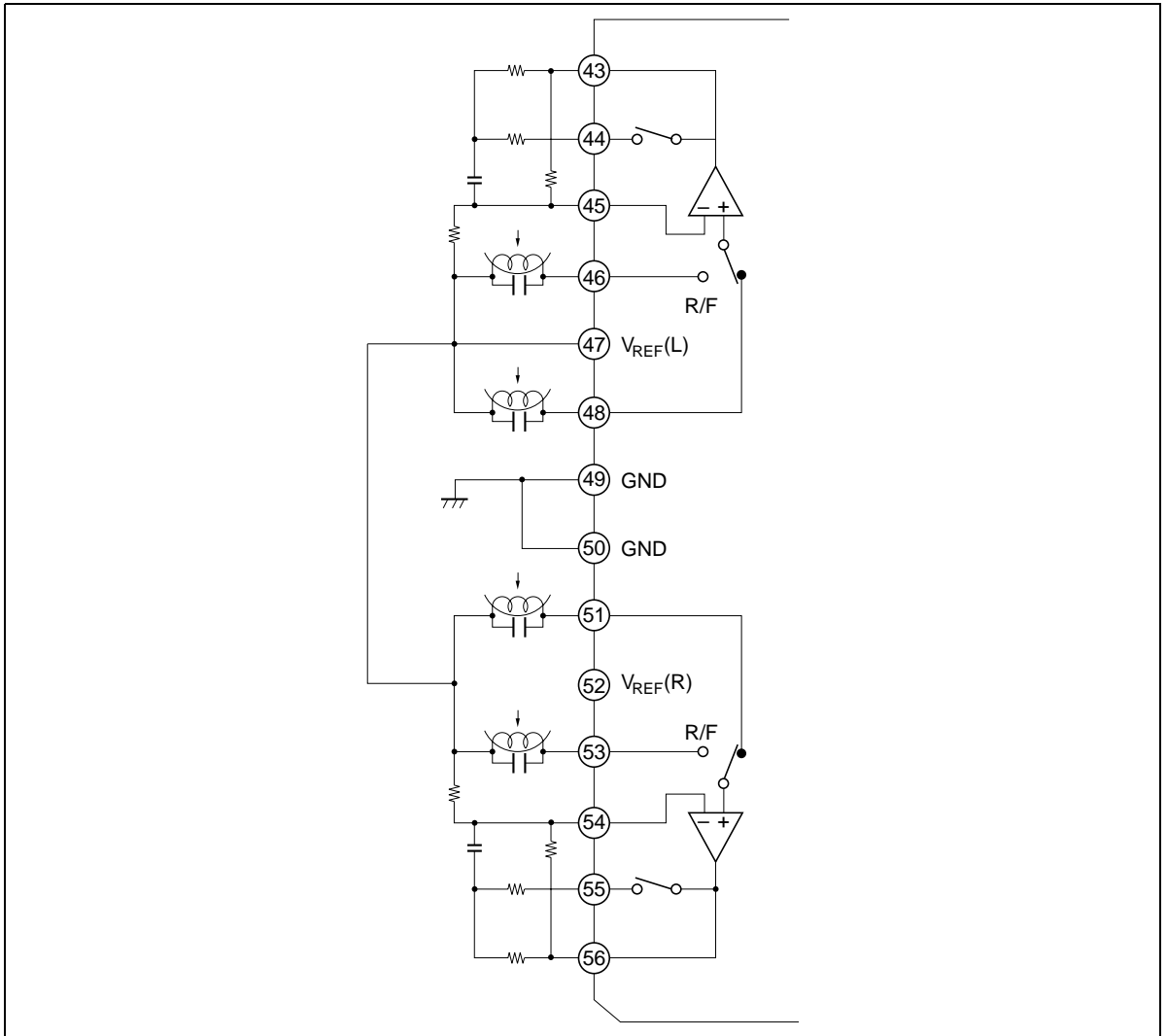

Figure 3 Application Circuit

7. The Sensitivity Adjustment of a Music Sensor

Adjusting MS AMP gain by external resistor, the sensitivity of music sensor can set up.

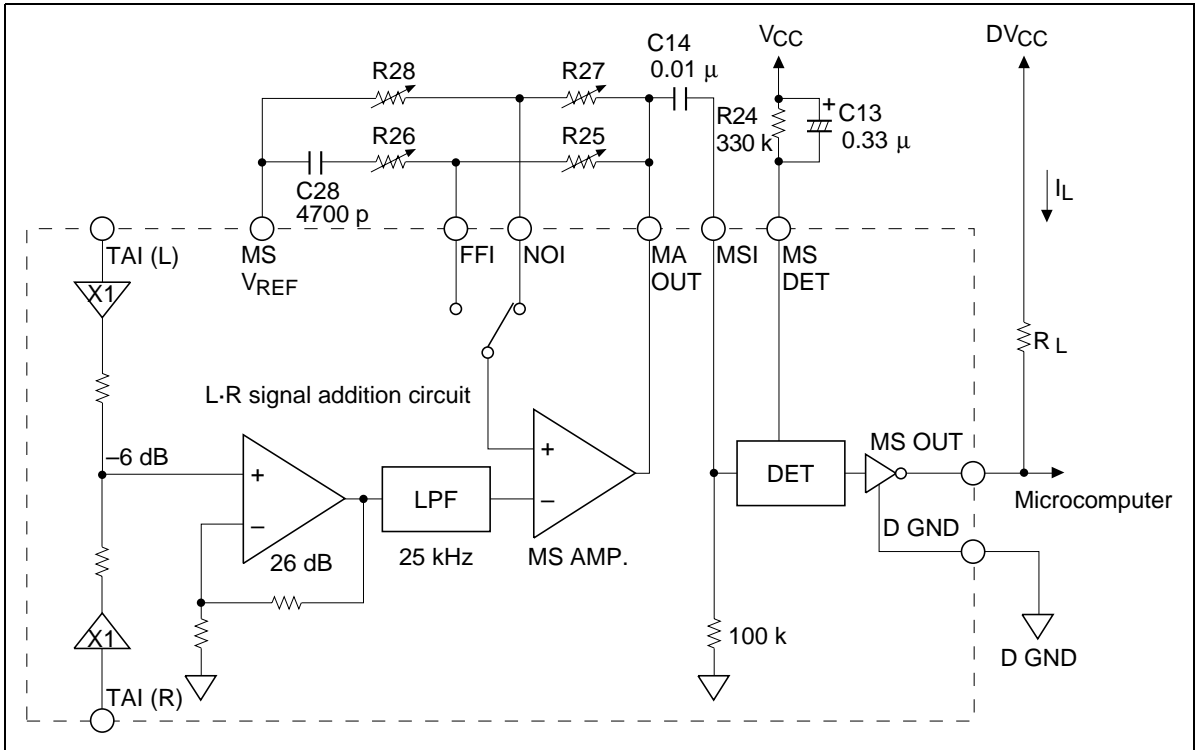

Figure 4 Music Sensor Block Diagram

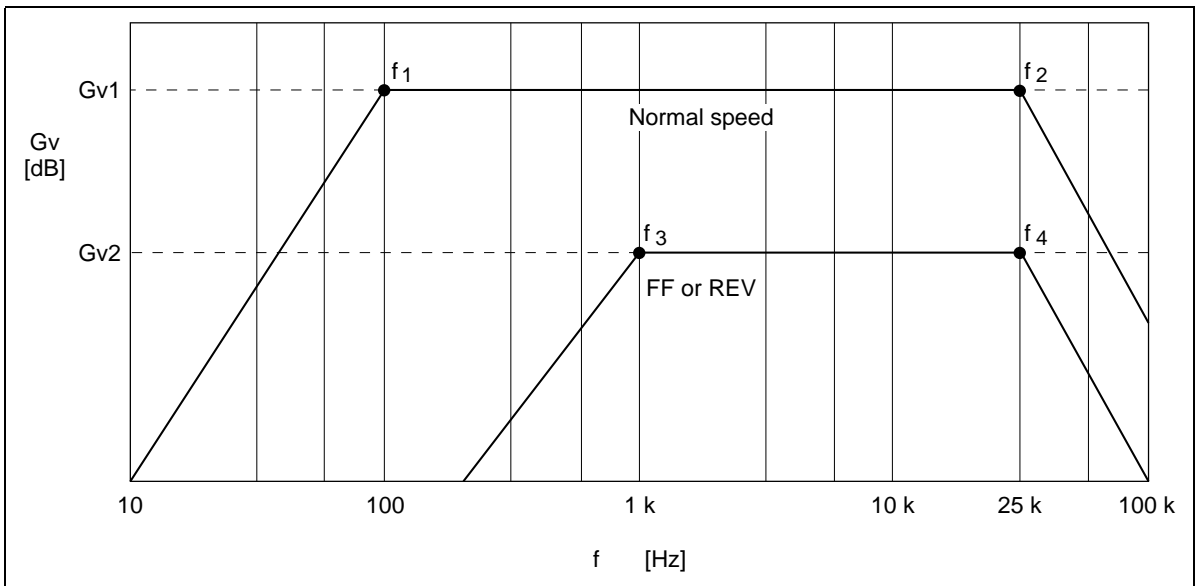

Figure 5 Frequency Response

HA12163 Series

A. Normal mode

$$Gv1 = 20 \log \left(1 + \frac{R27}{R28} \right) [\text{dB}]$$

$$f1 = \frac{1}{2 \cdot \pi \cdot C14 \cdot 100 \text{ k}} [\text{Hz}], f2 = 25 \text{ k} [\text{Hz}]$$

B. FF or REW mode

$$Gv2 = 20 \log \left(1 + \frac{R25}{R26} \right) [\text{dB}]$$

$$f3 = \frac{1}{2 \cdot \pi \cdot C28 \cdot R26} [\text{Hz}], f4 = 25 \text{ k} [\text{Hz}]$$

A standard level of TAI pin is 30 mVrms and the gain for TAI to MS AMP input is 10, therefore, the other channel sensitivity of music sensor (S) is computed by the formula mentioned below.

$$S = 20 \log \left(\frac{C}{30} \cdot \frac{1}{10 \cdot A} \right) [\text{dB}]$$

A = MS AMP. gain (B dB)

C = The sensing level of music sensor

S = -7.3-B [dB] C = 130 mVrms (typ.)

S is 6 dB up in case of the both channels.

8. Music Sensor Output (MS OUT)

As for the internal circuit of music sensor block, music sensor output pin is connected to the collector of NPN Type directly, therefore, output level will be “high” when sensing no signal. And output level will be “low” when sensing signal.

Connection with microcomputer, design I_L at 1 mA typ.

$$I_L = \frac{DV_{CC} - MSOUT_{Lo}^*}{R_L}$$

* $MSOUT_{Lo}$: sensing signal (about 1 V)

- Notes: 1. Supply voltage of MS OUT pin must be less than V_{CC} voltage.
2. MS V_{CC} pin and V_{CC} pin are required the same voltage.

9. The Tolerances of External Components for Dolby NR-block

For adequate Dolby NR tracking response, take external components shown below.

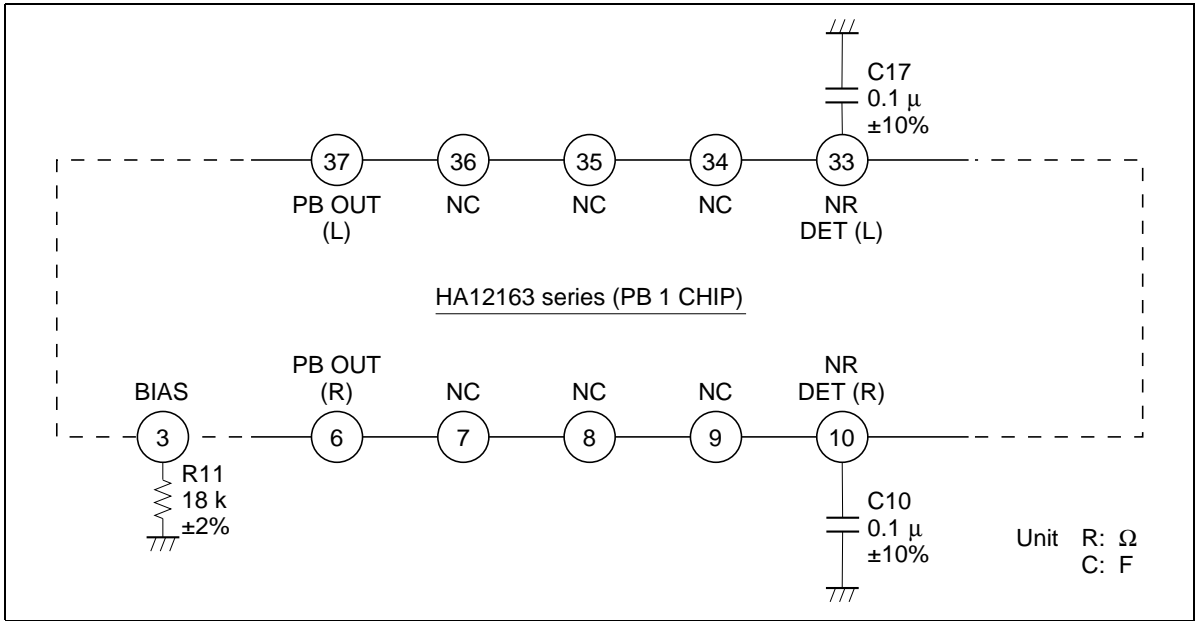

Figure 6 Tolerances of External Components

HA12163 Series

10. PB Equalizer for Double Speed

PB equalizer can be design for double speed by using external components shown in figure 7. Application data is shown in figure 8.

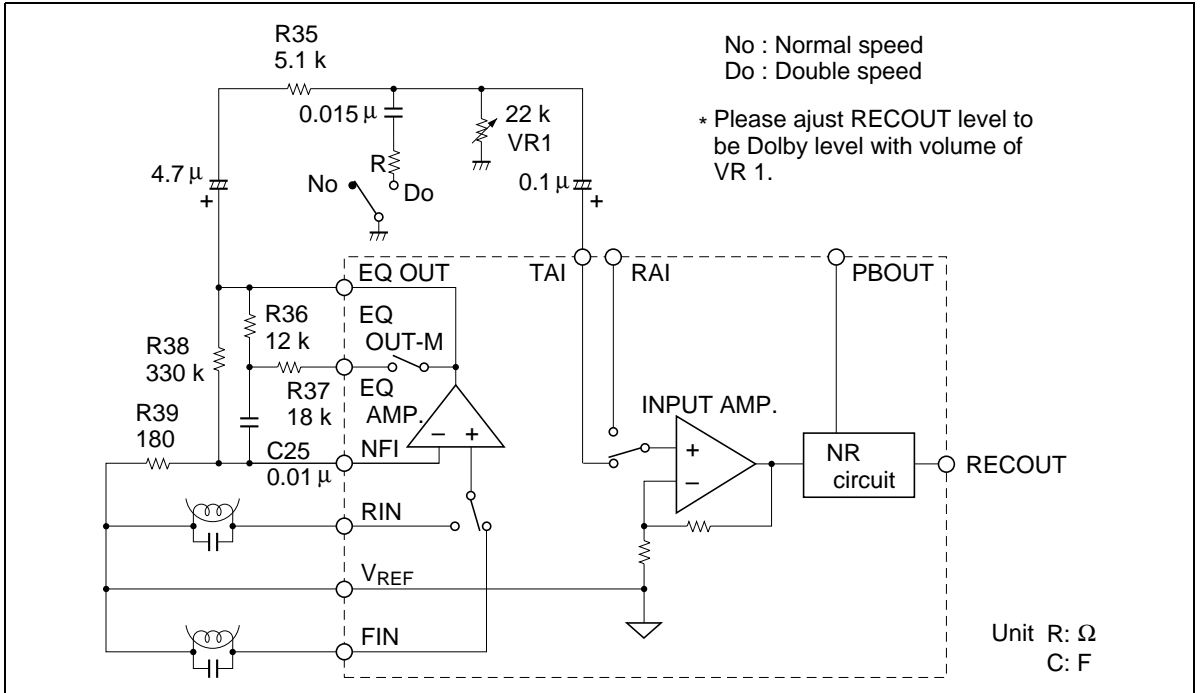

Figure 7 Application Circuit for Double Speed

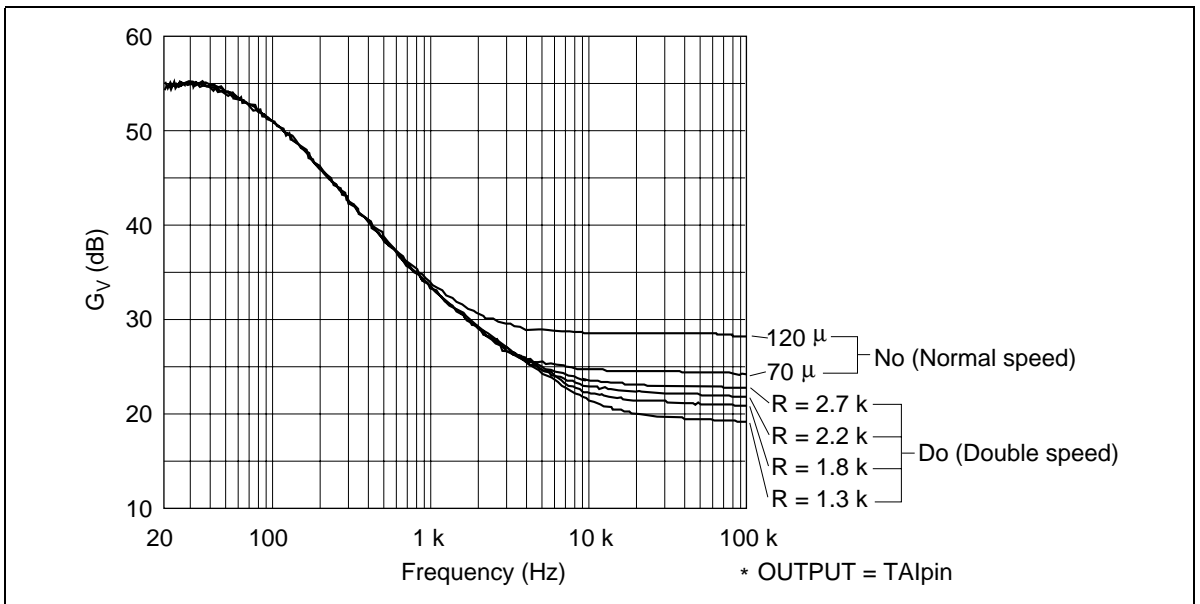
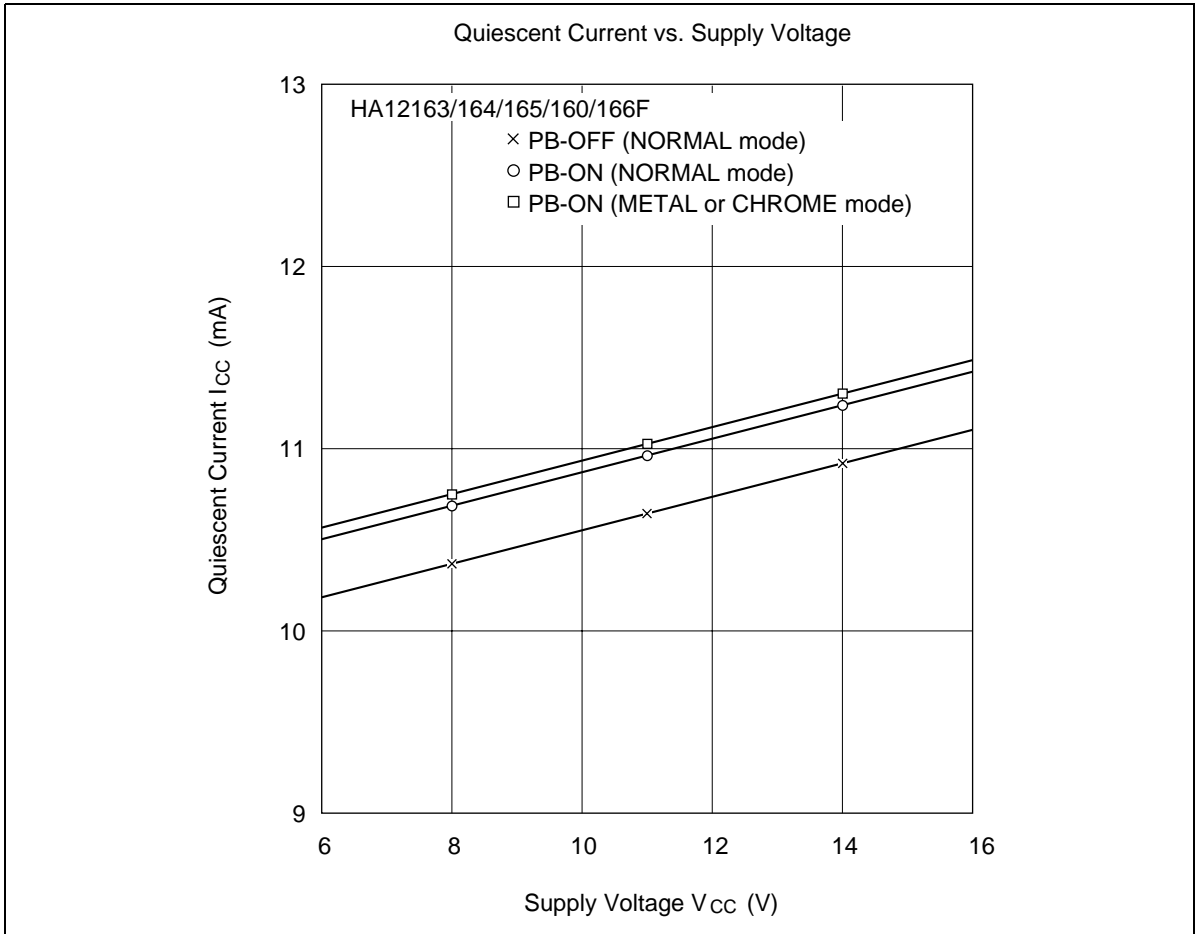

Figure 8 Application Data

Typical Characteristic Curves



HA12163 Series

HA12163 Data

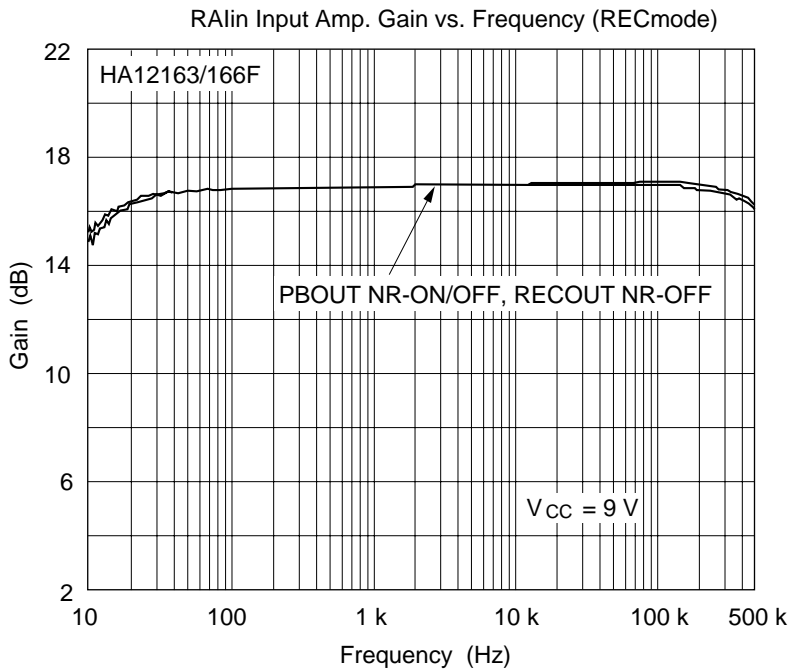
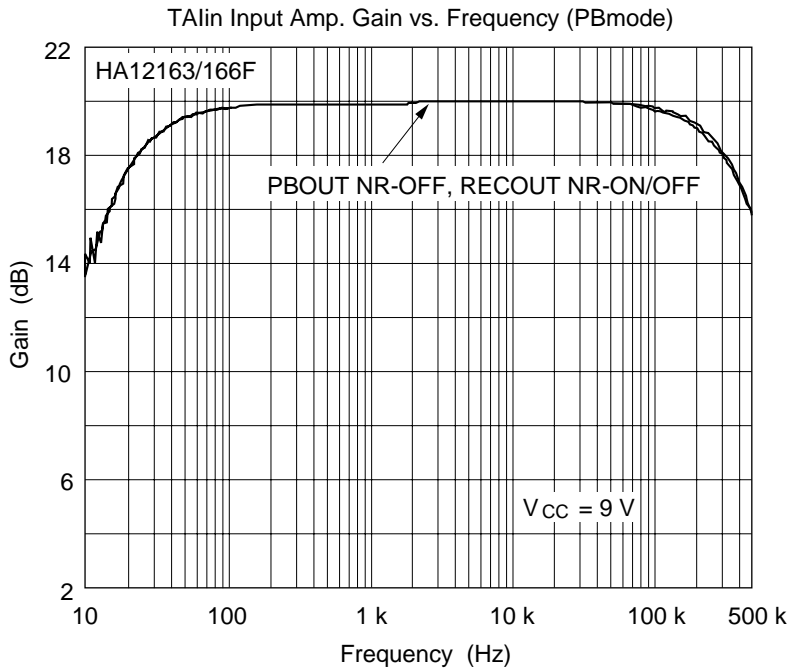

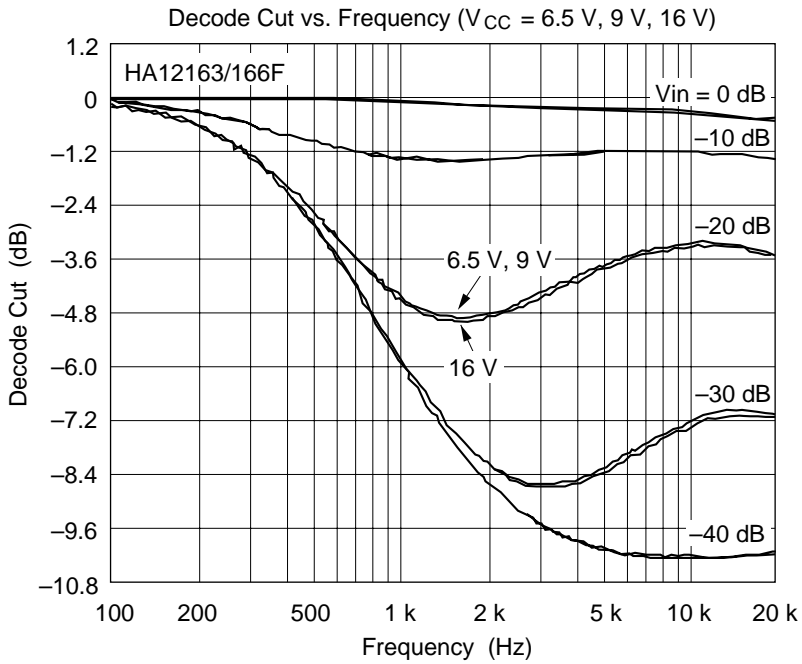
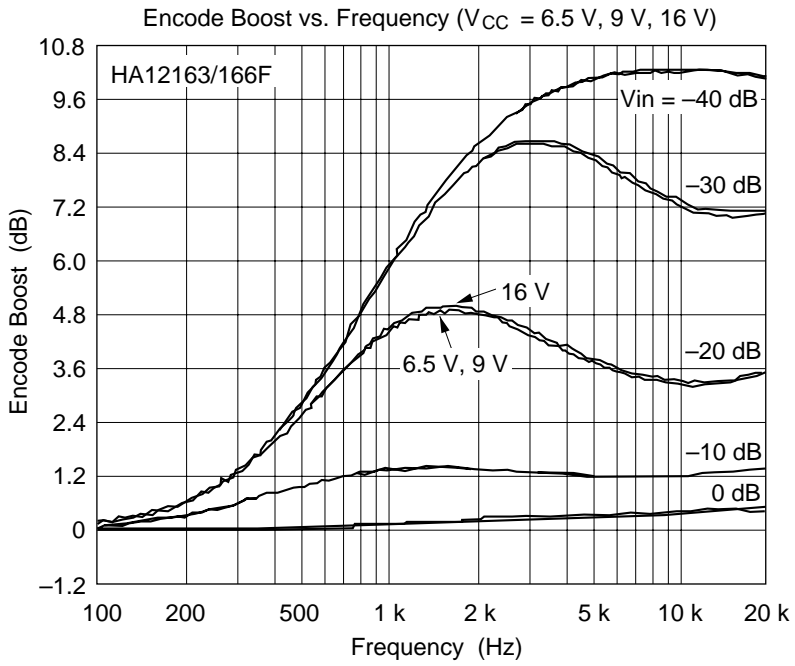

HA12163 Series

Maximum Output Level vs. Supply Voltage (1)
(RAIn RECmode RECOUT)

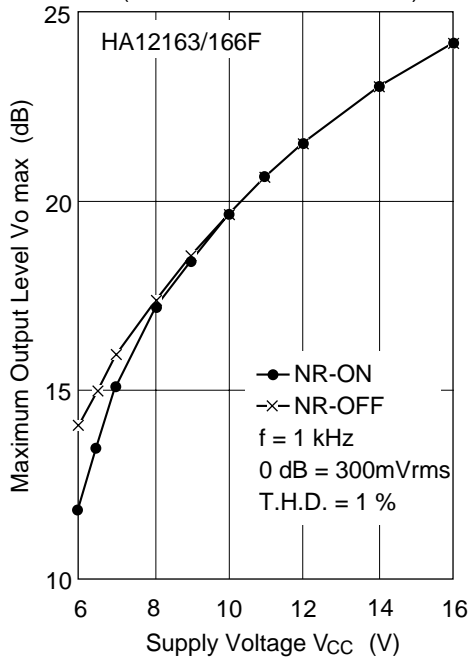

Maximum Output Level vs. Supply Voltage (2)
(RAIn PBmode PBOUt)

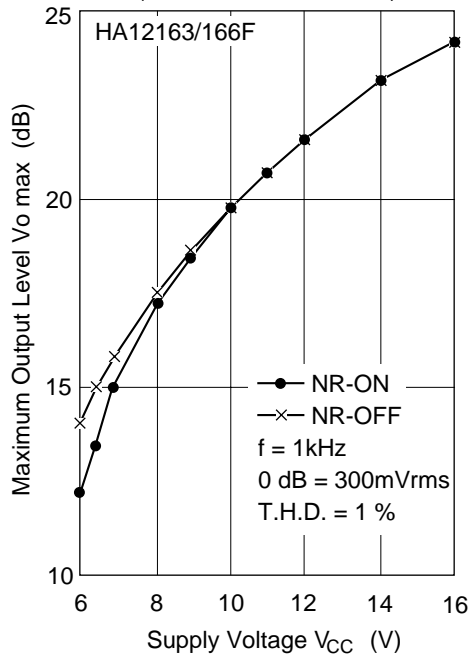

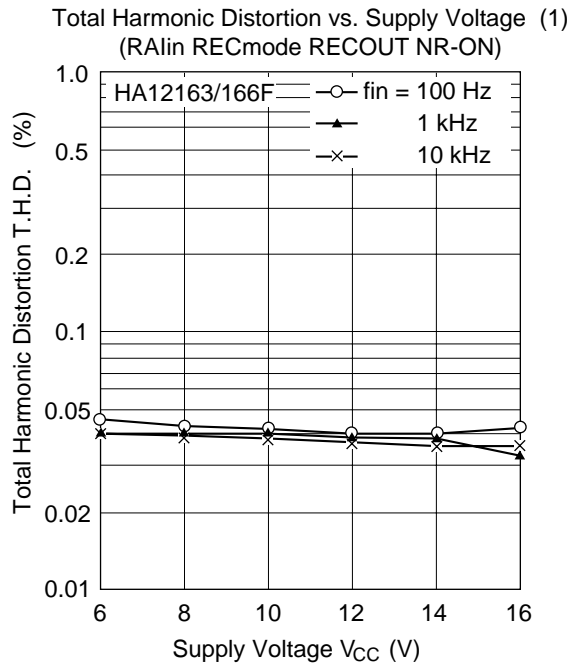
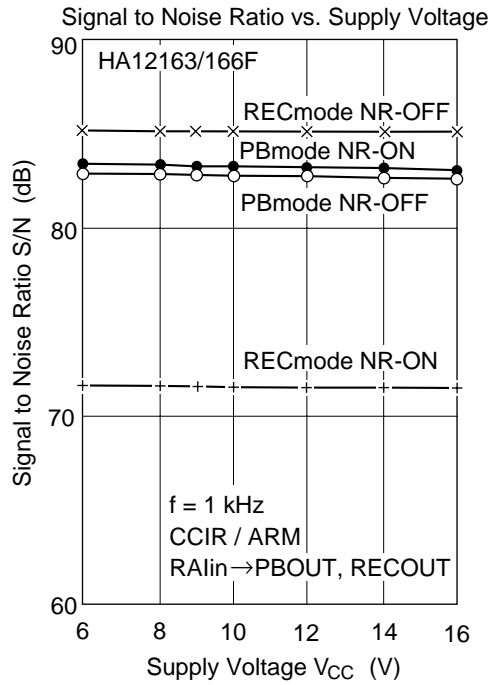

Total Harmonic Distortion vs. Supply Voltage (2)
(RALin RECmode RECOUT NR-OFF)

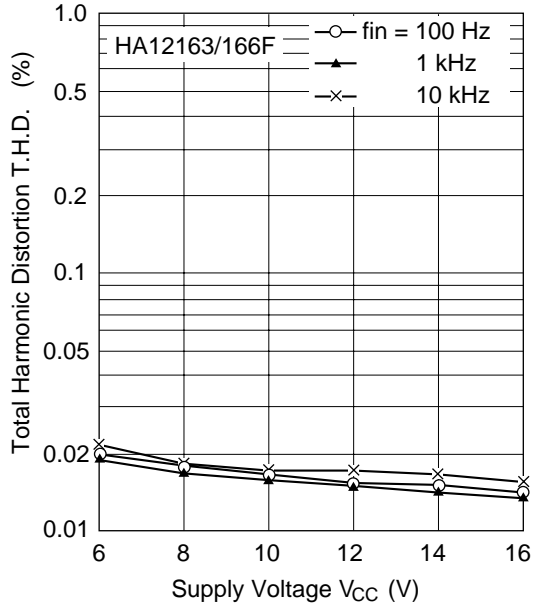

Total Harmonic Distortion vs. Supply Voltage (3)
(RALin PBmode PBOUT NR-ON)

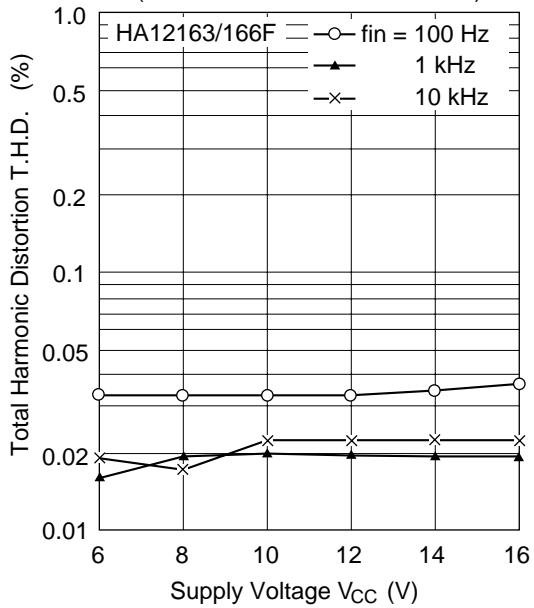

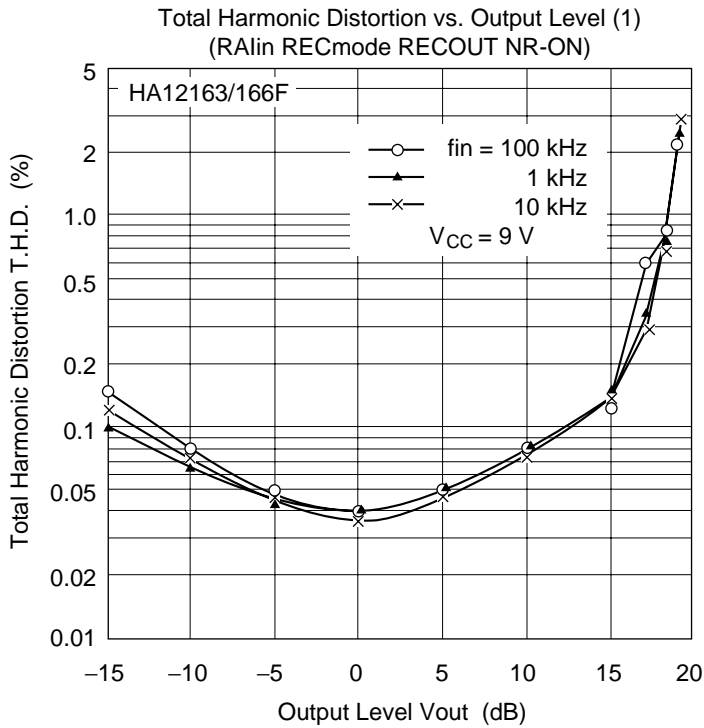
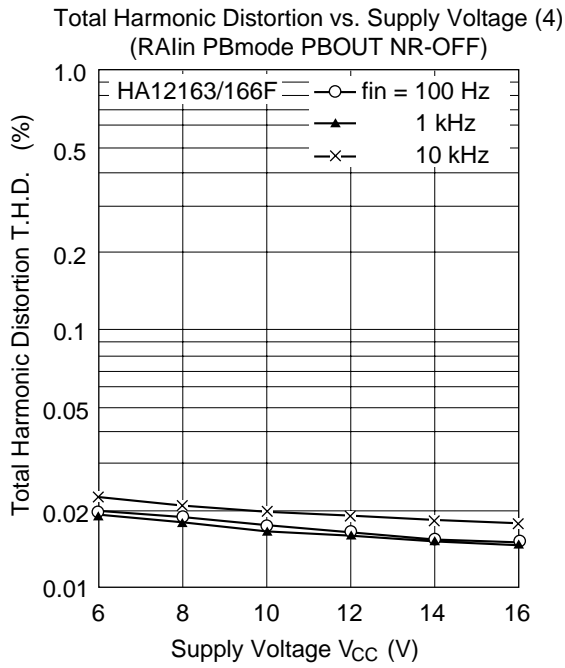

Total Harmonic Distortion vs. Output Level (2)
(RALin RECmode RECOUT NR-OFF)

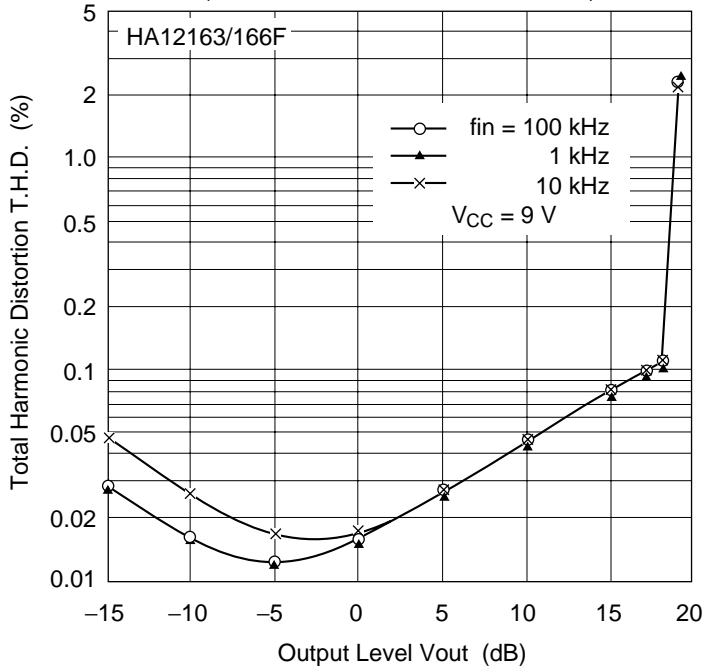

Total Harmonic Distortion vs. Output Level (3)
(RALin PBmode PBOUT NR-ON)

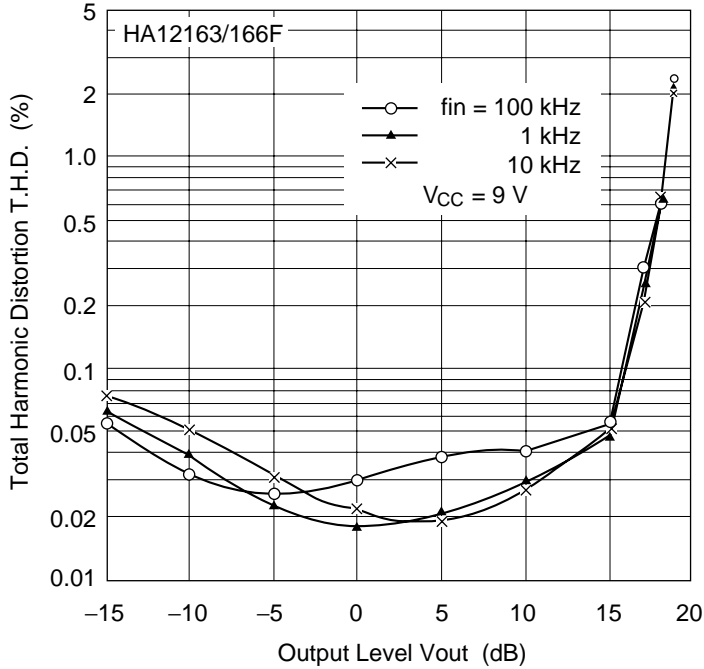

Total Harmonic Distortion vs. Output Level (4)
(RALin PBmode PBOUT NR-OFF)

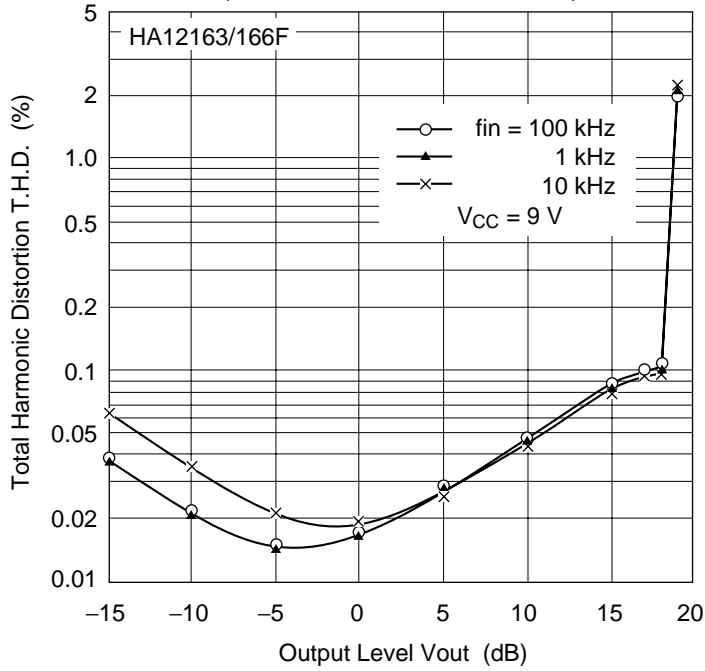

Total Harmonic Distortion vs. Frequency (RALin RECmode RECOUT NR-ON) (1)

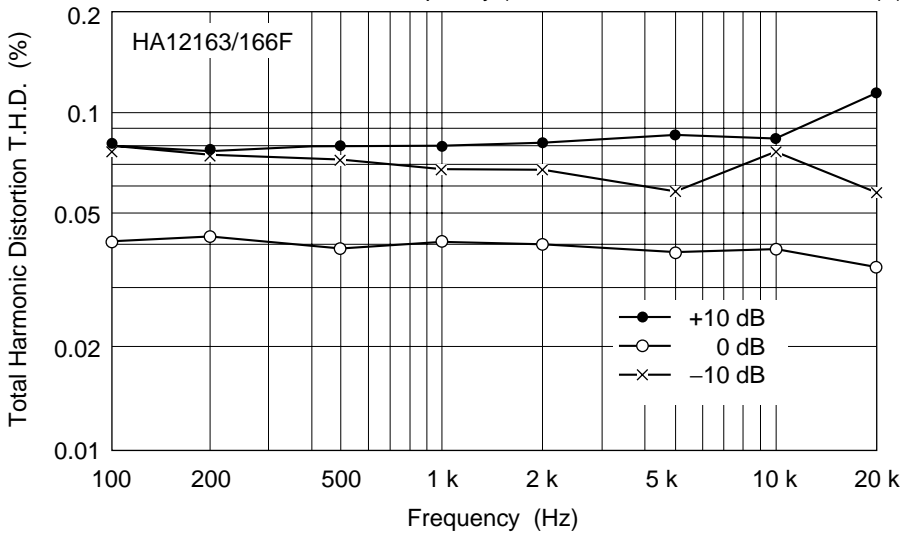

HA12163 Series

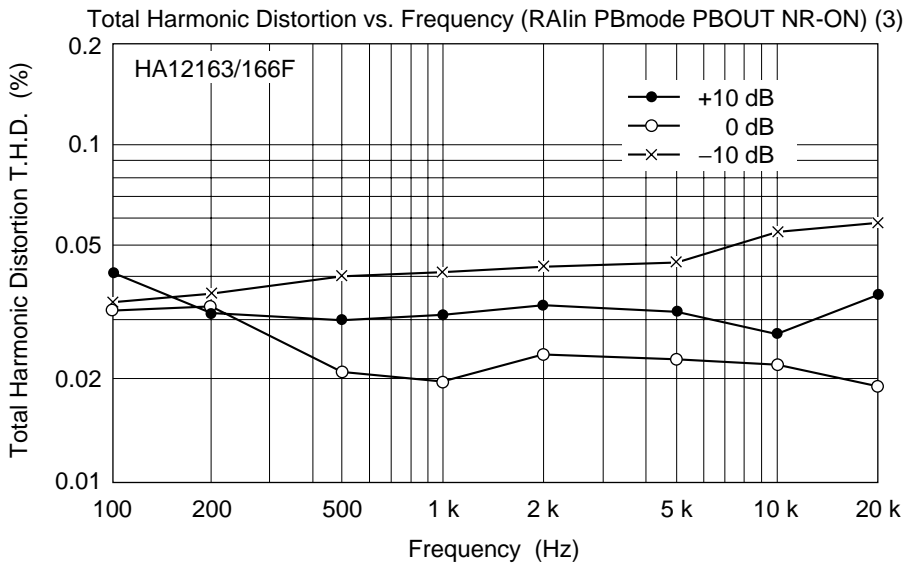
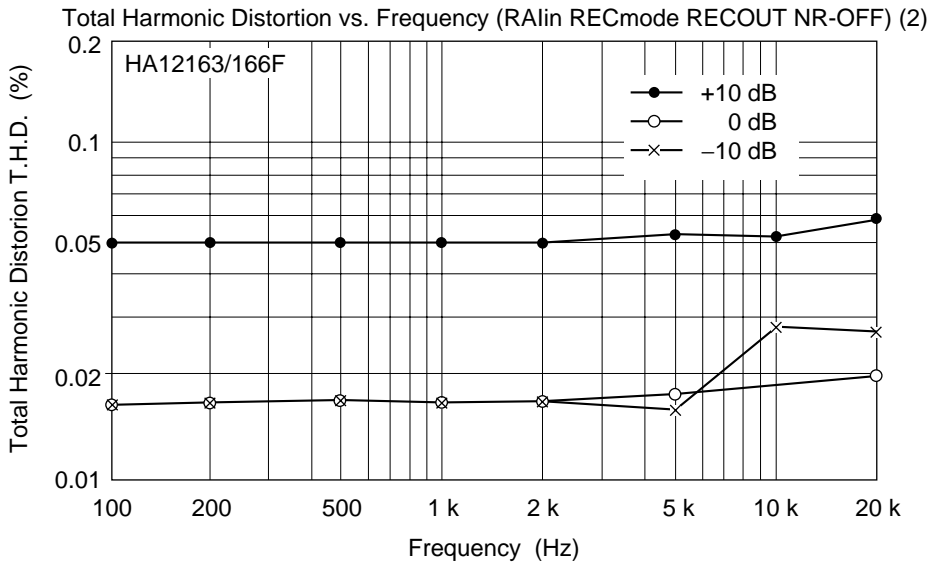

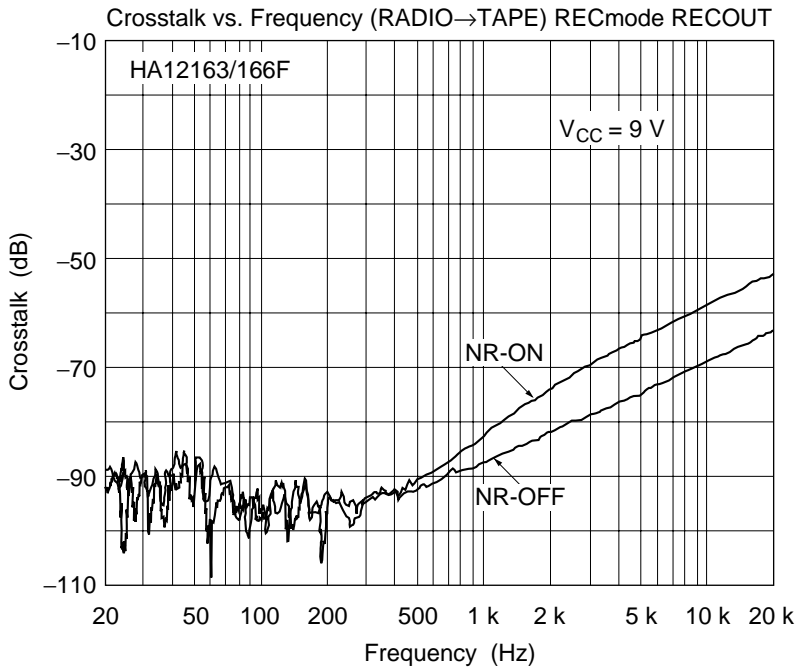
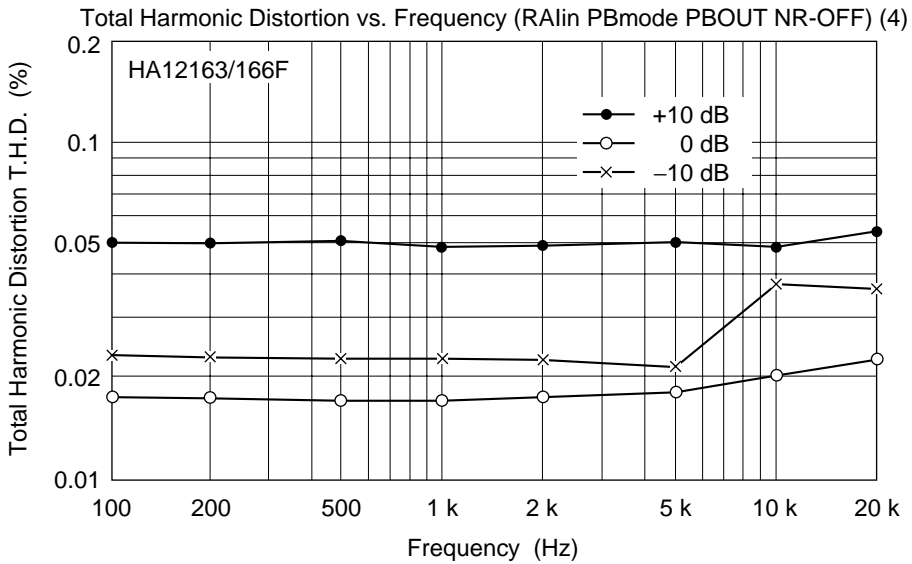

HA12163 Series

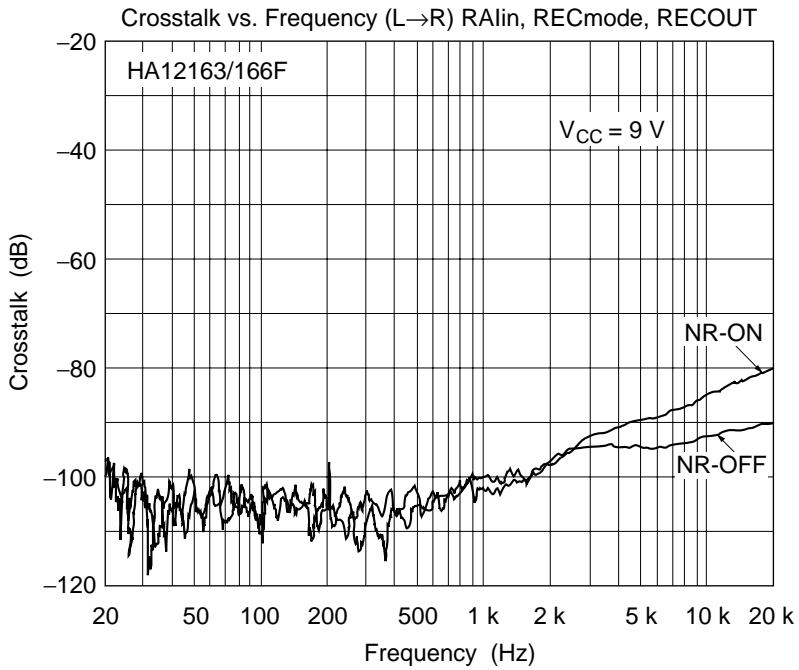
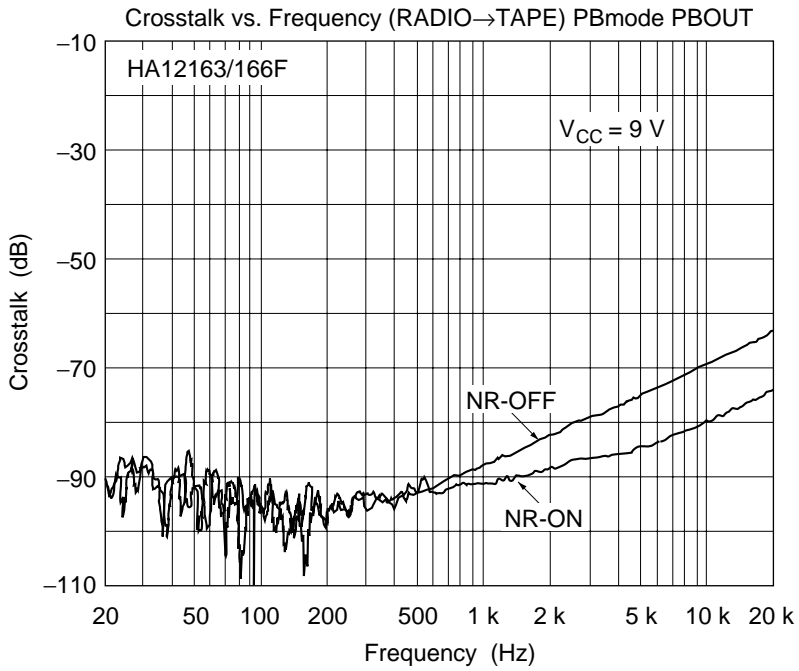

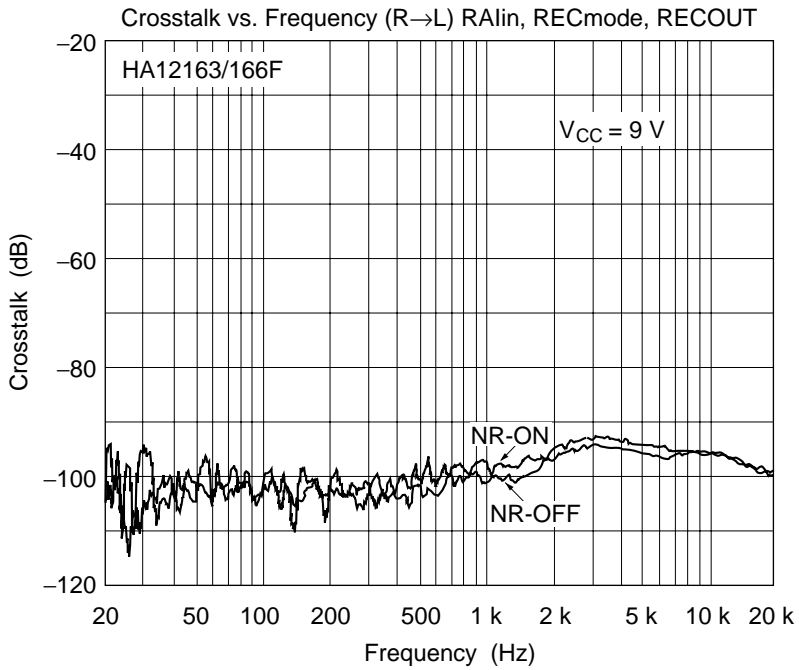
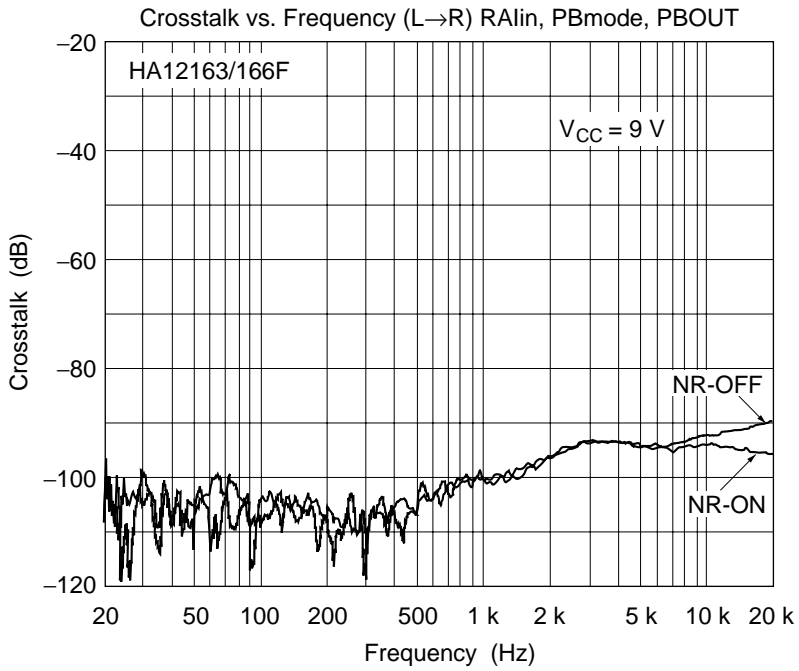

HA12163 Series

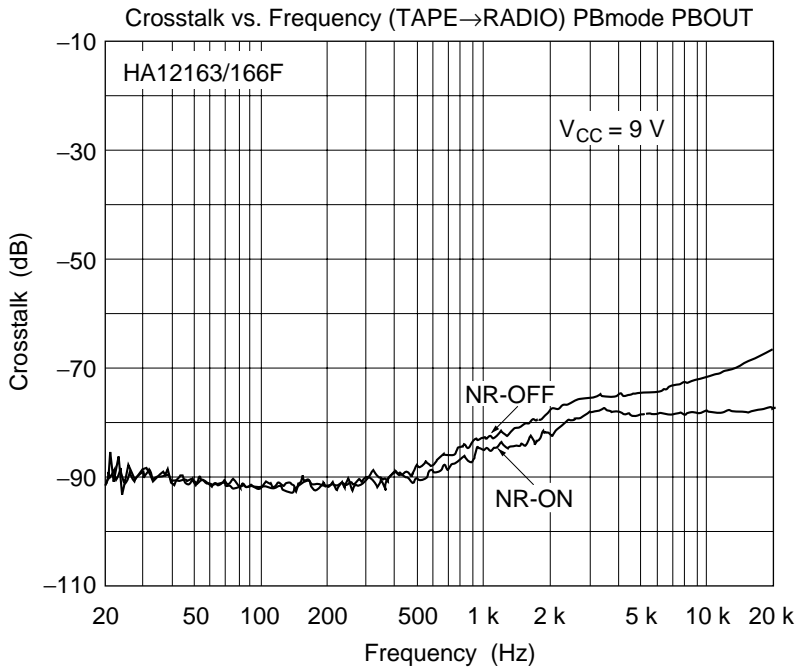
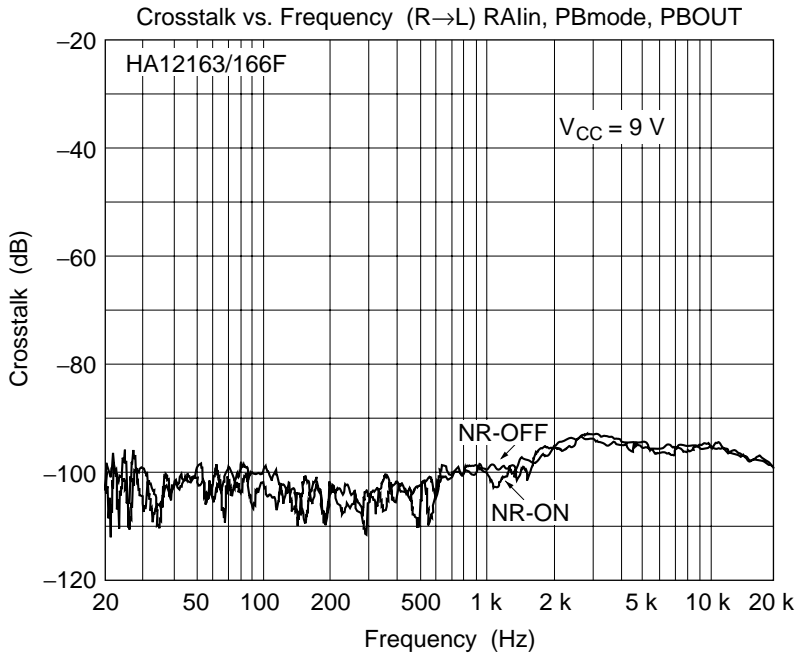

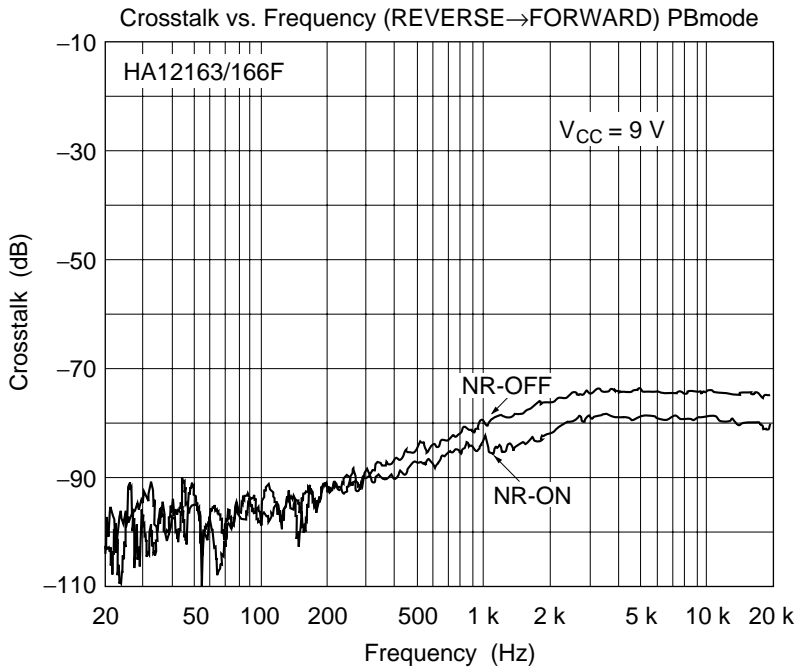
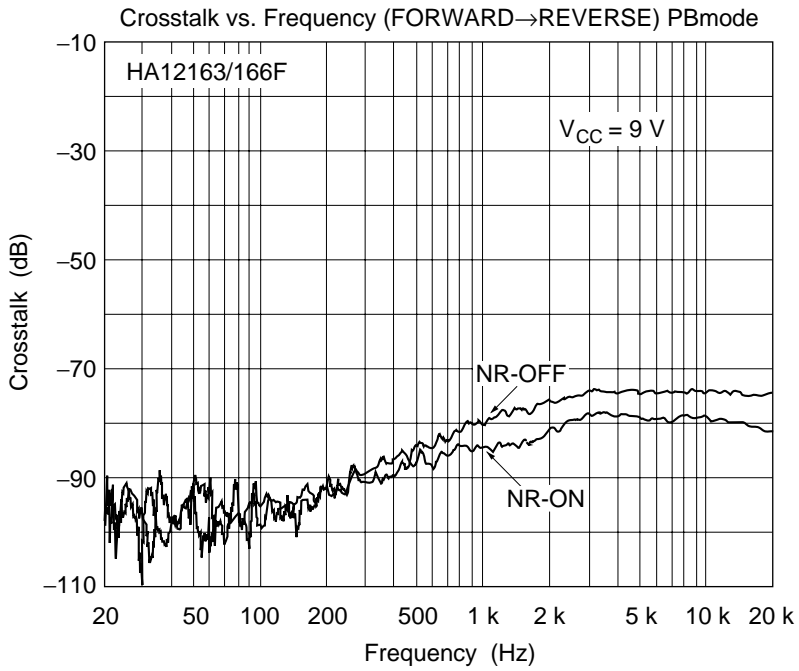

HA12163 Series

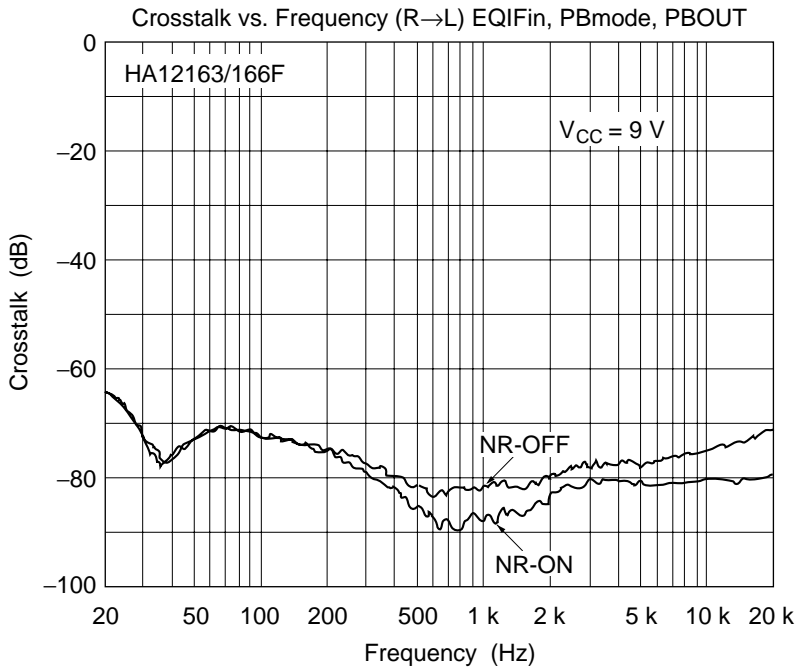
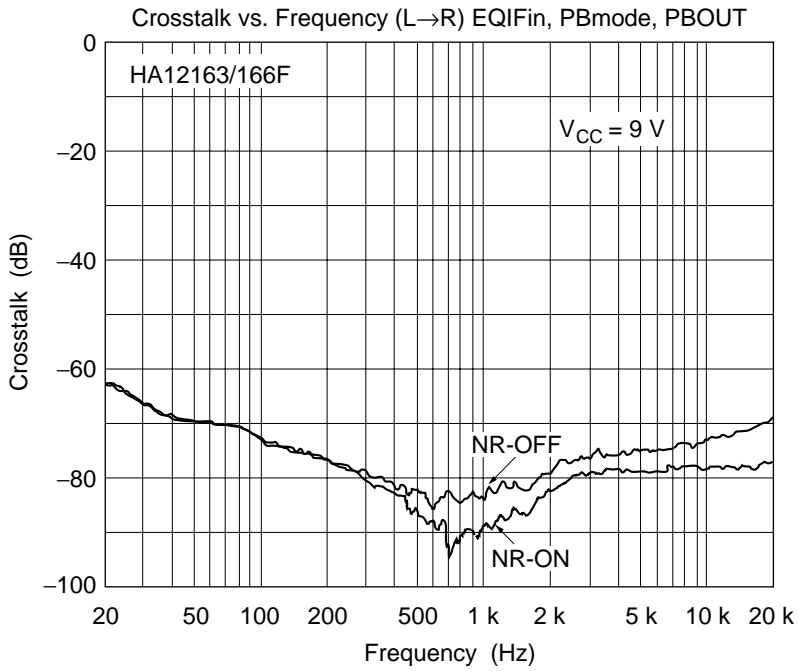

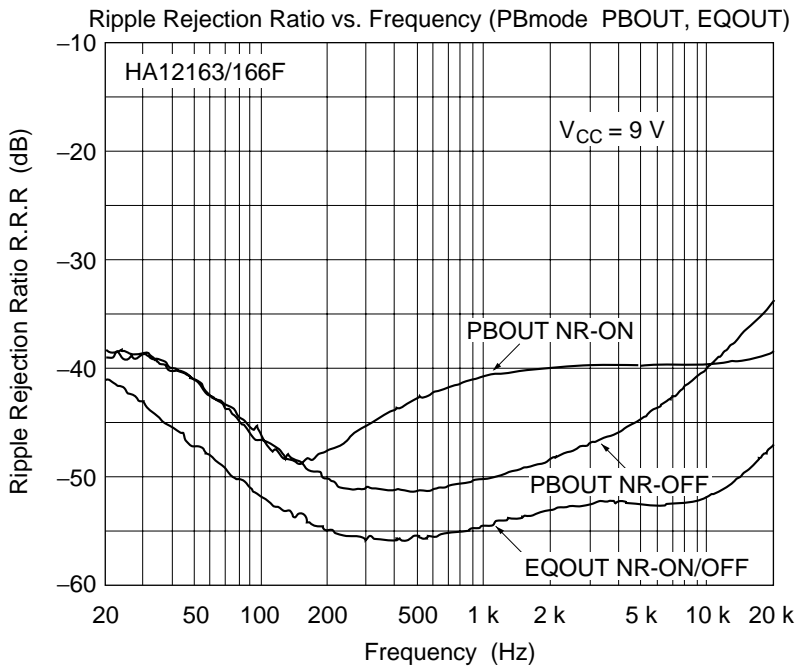
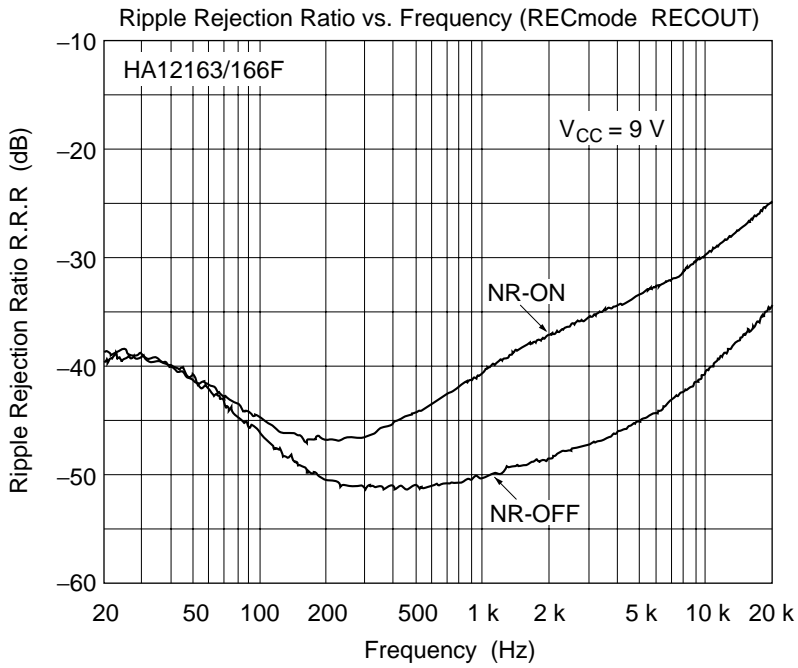

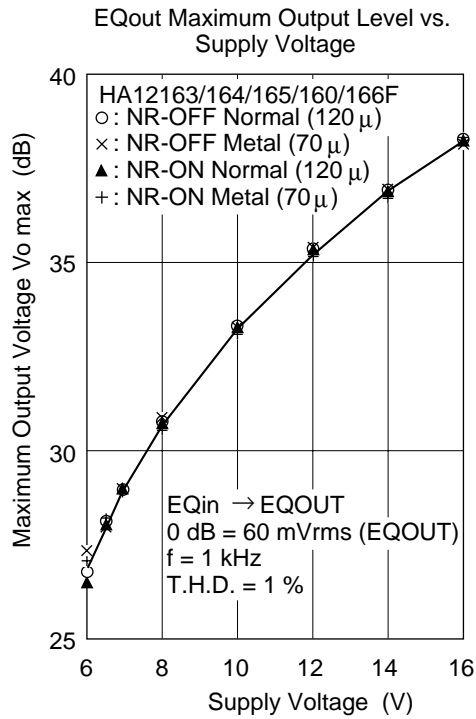
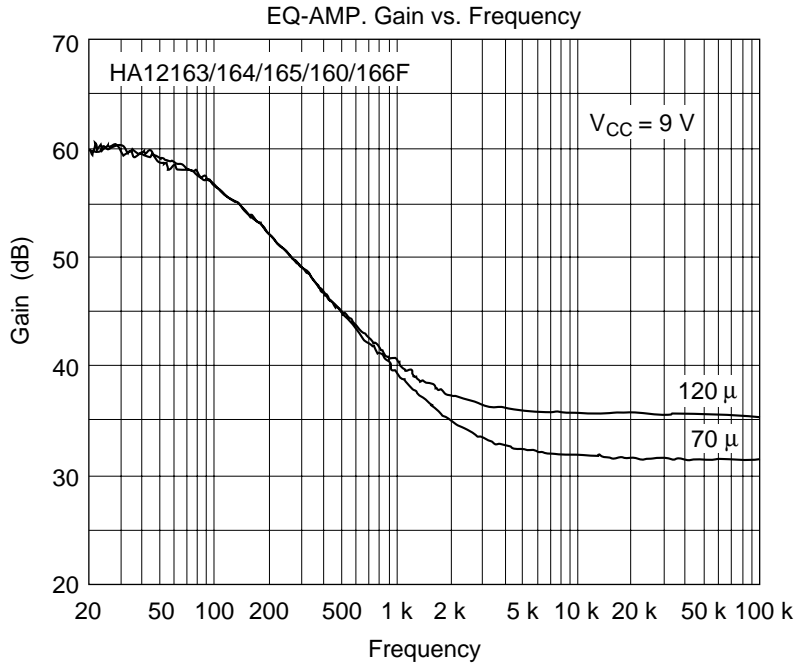

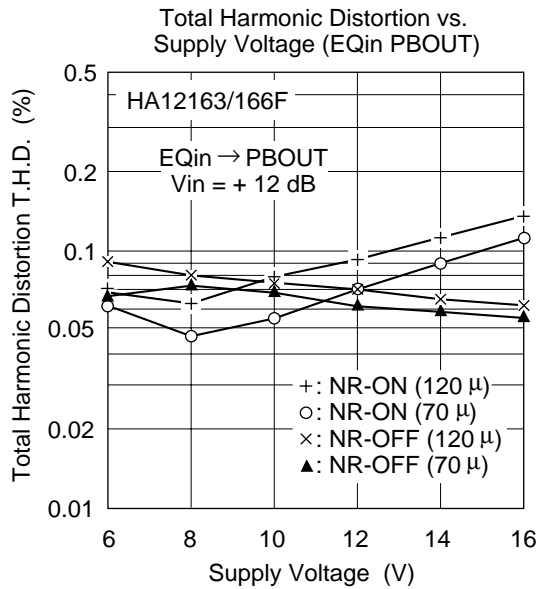
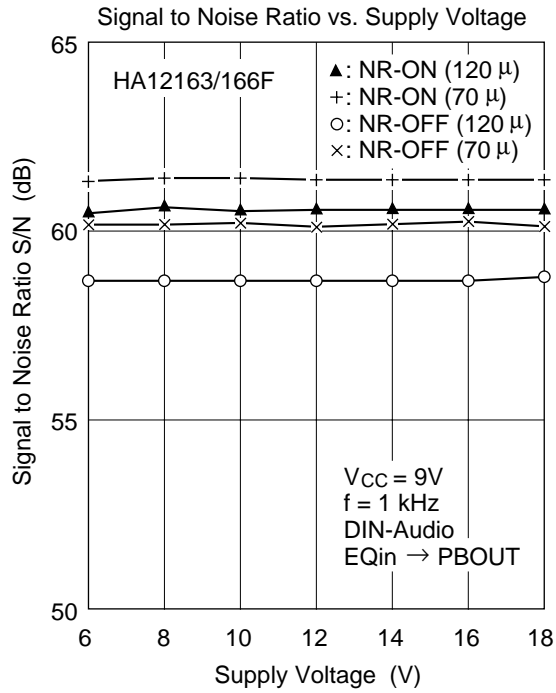

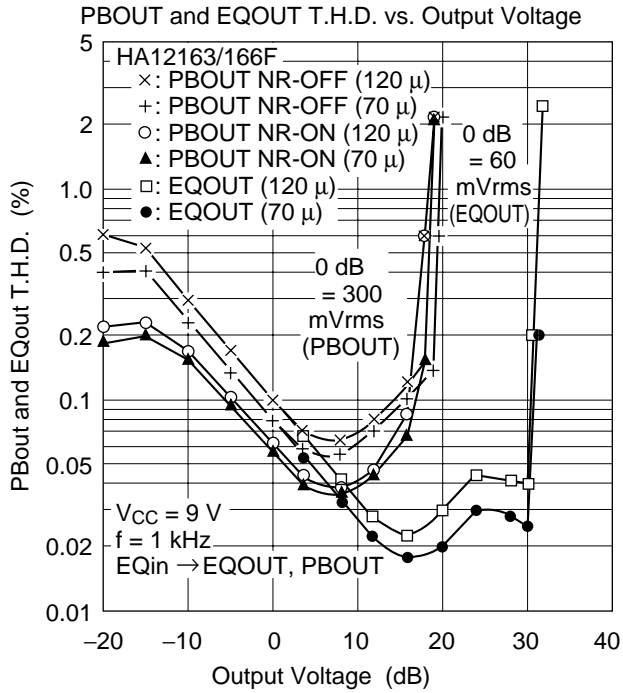

Total Harmonic Distortion vs. Frequency (EQin PBmode PBOUT)

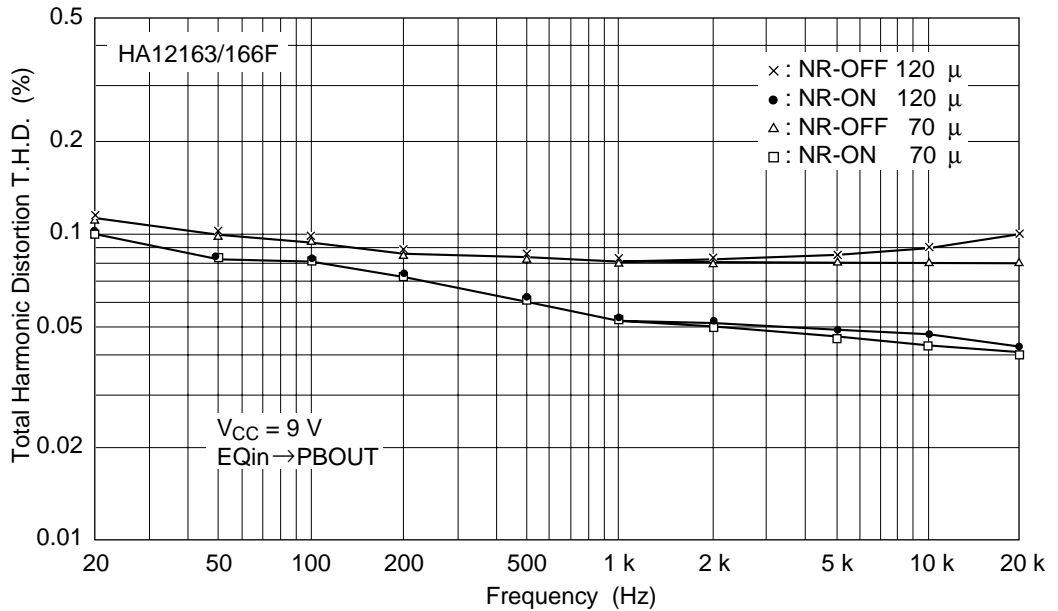

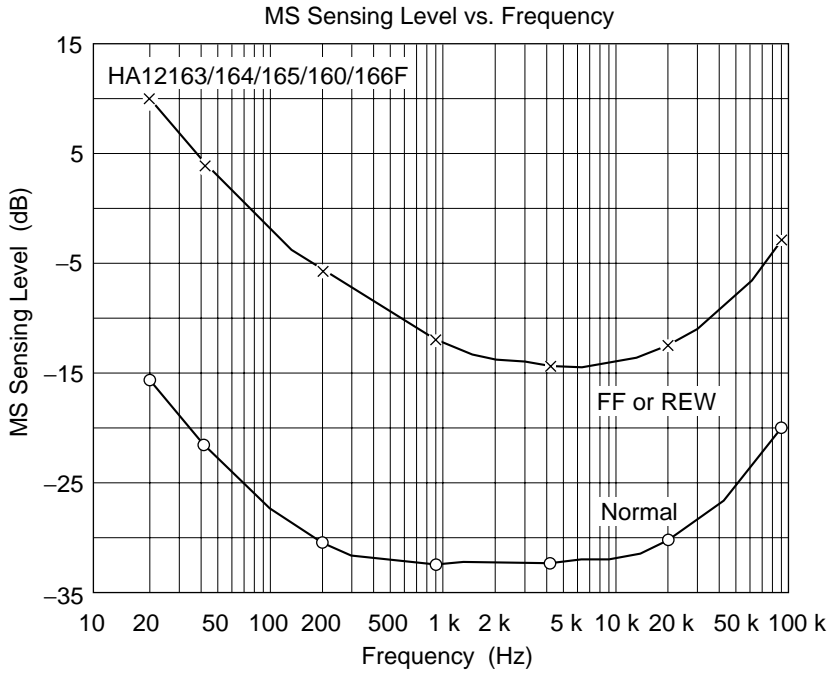
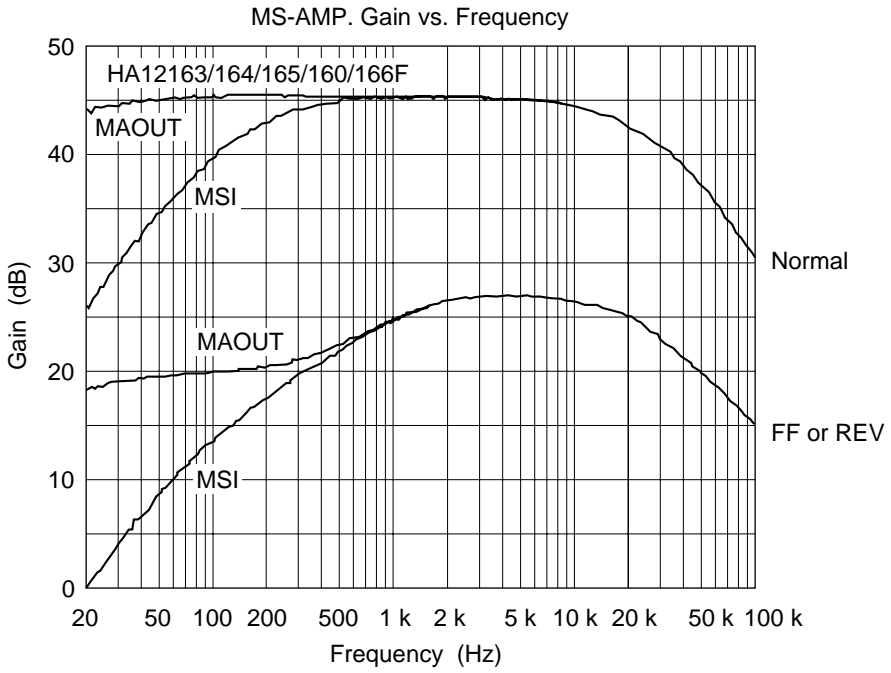

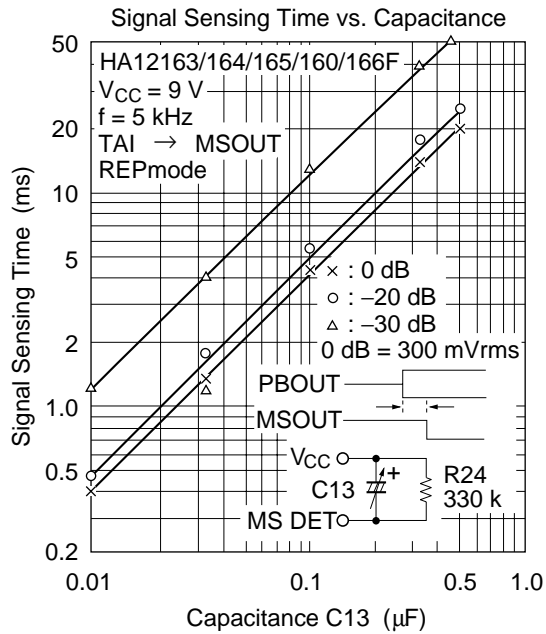
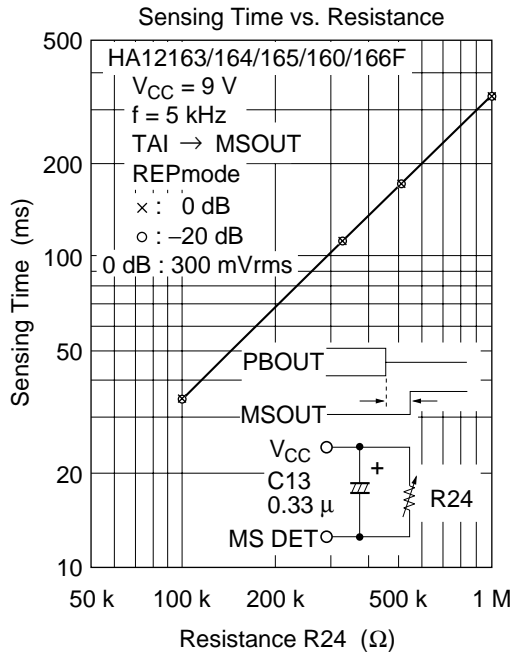

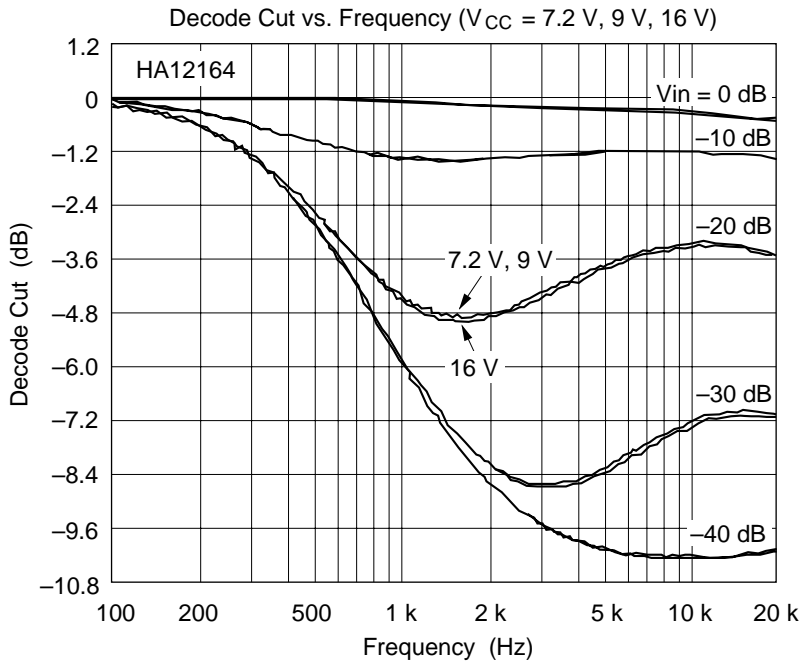
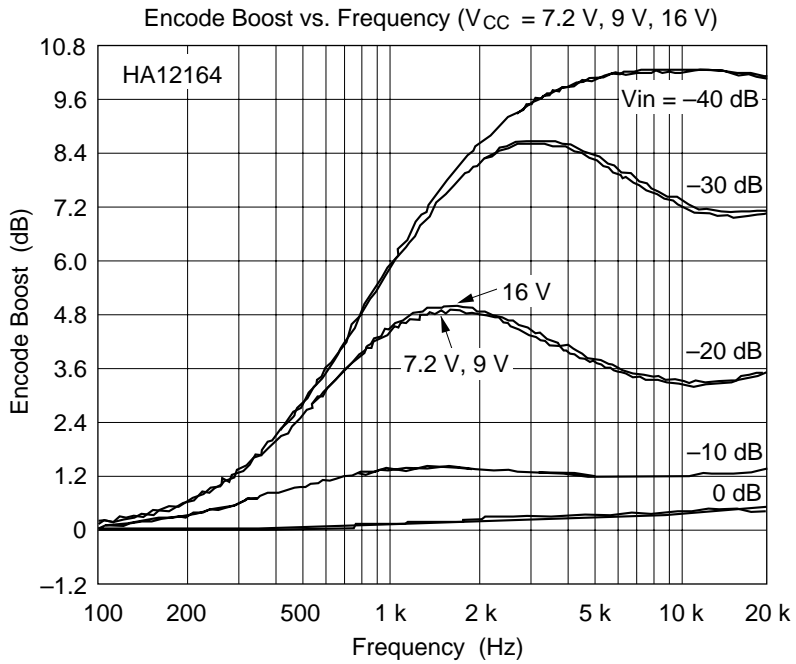

HA12163 Series

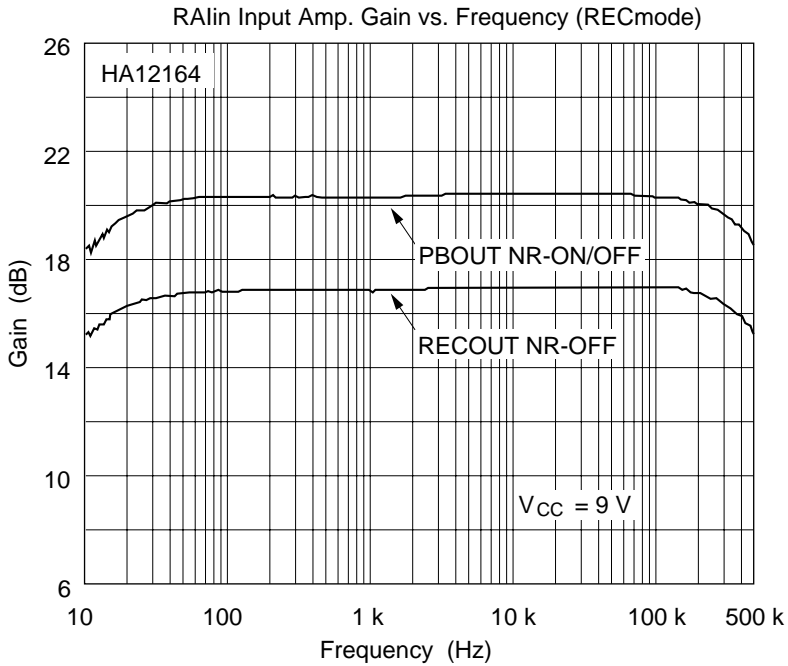
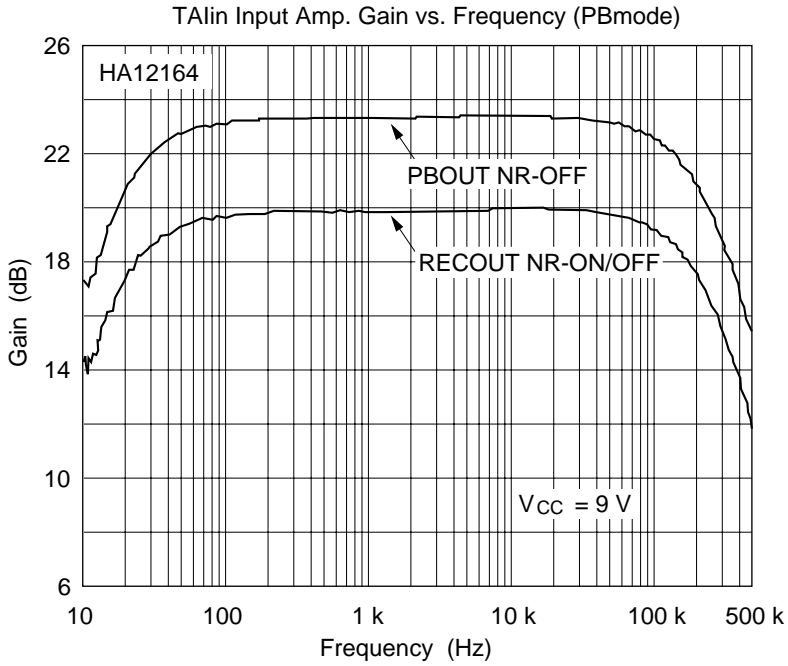

Maximum Output Level vs. Supply Voltage (1)
(RAIn RECmode RECOU)

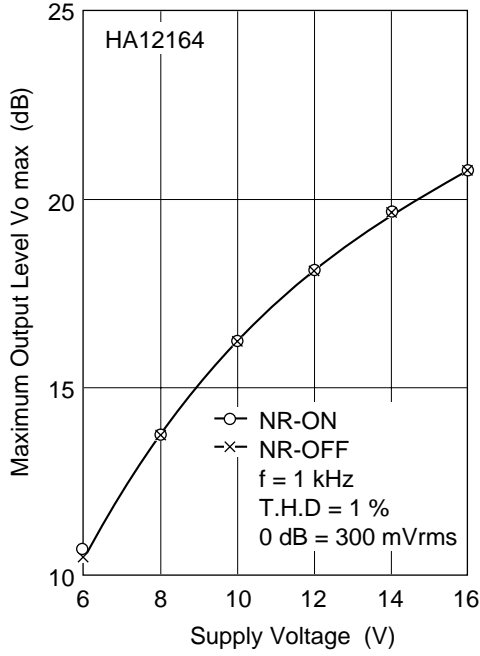

Maximum Output Level vs. Supply Voltage (2)
(RAIn PBmode PBOU)

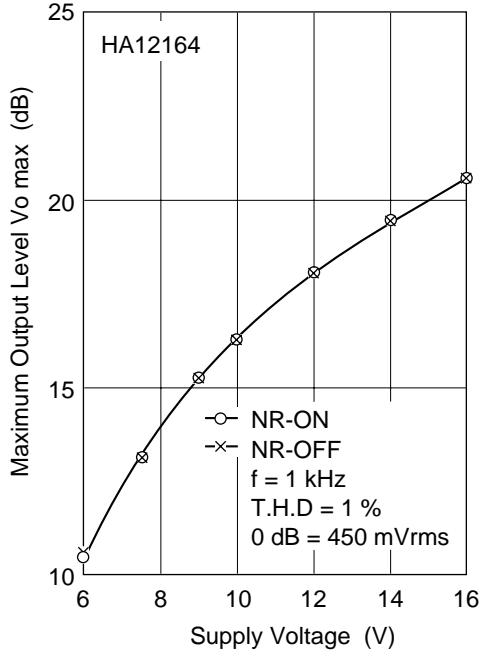

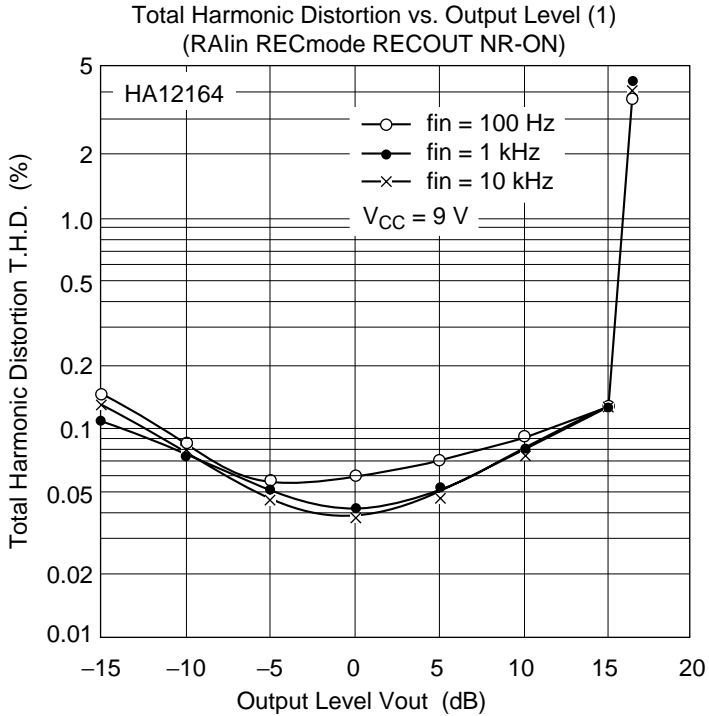
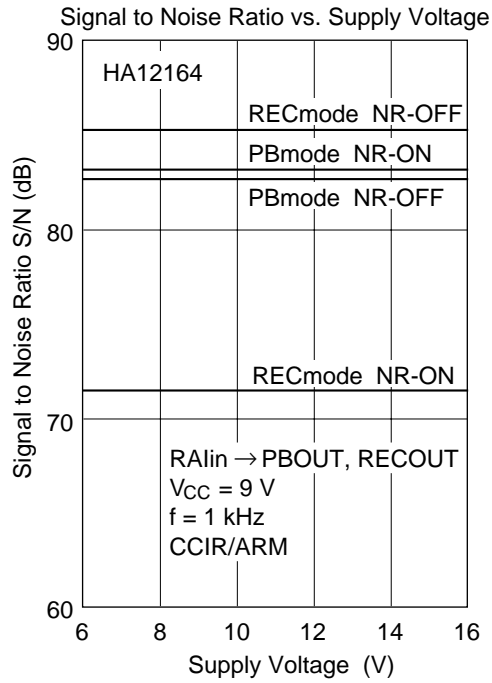

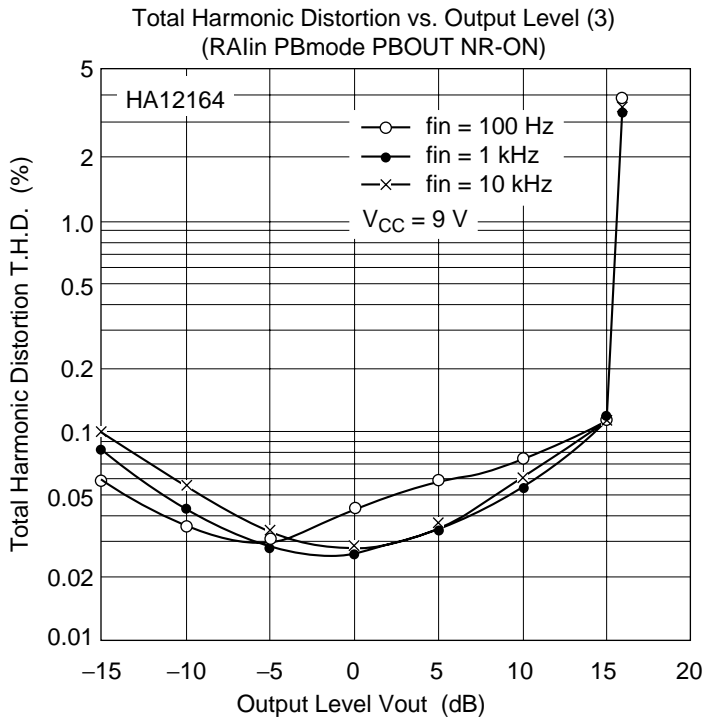
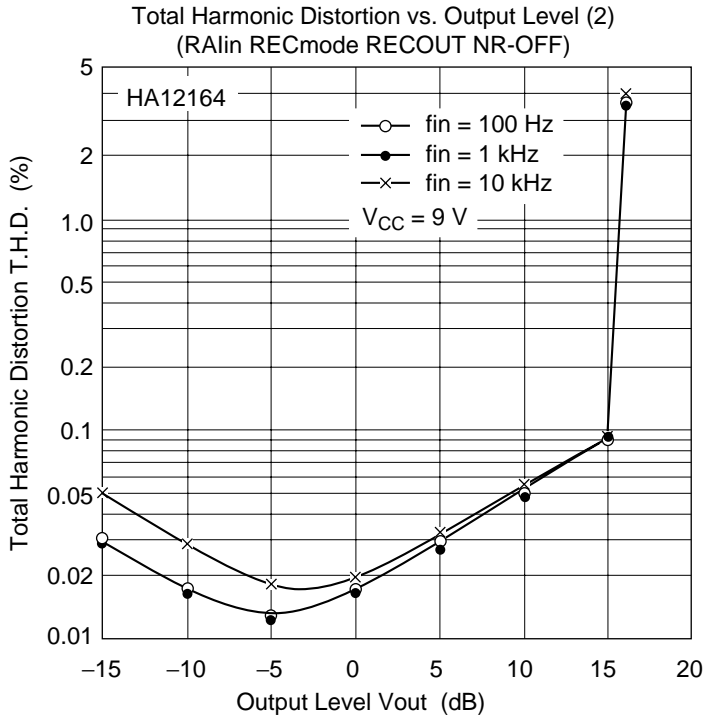

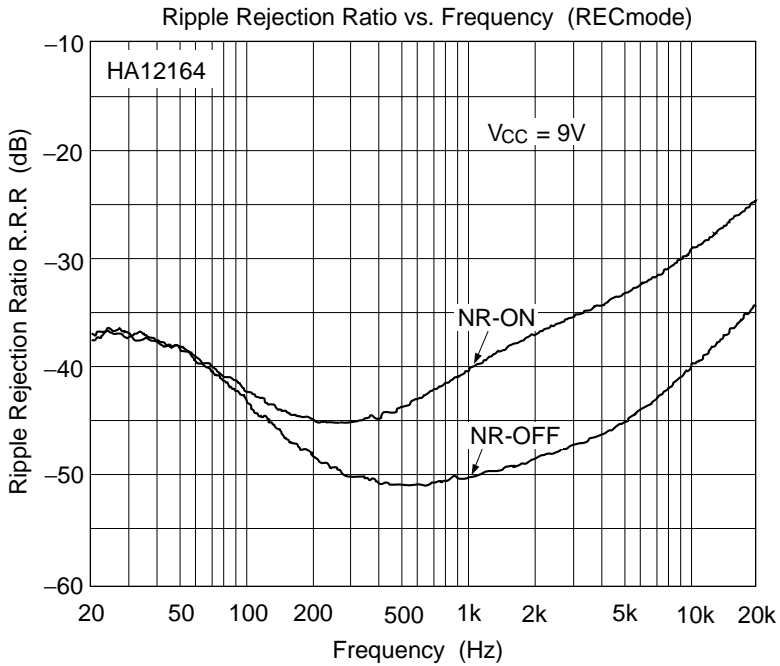
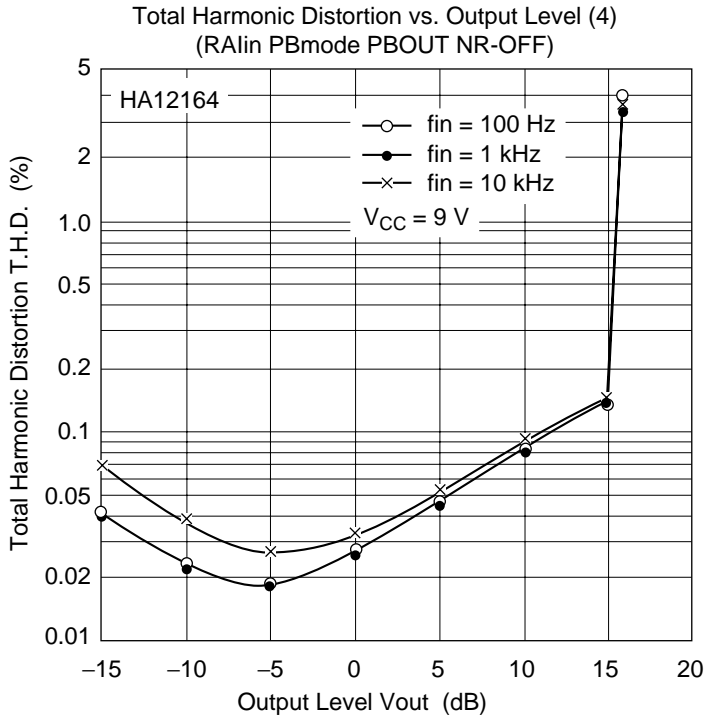

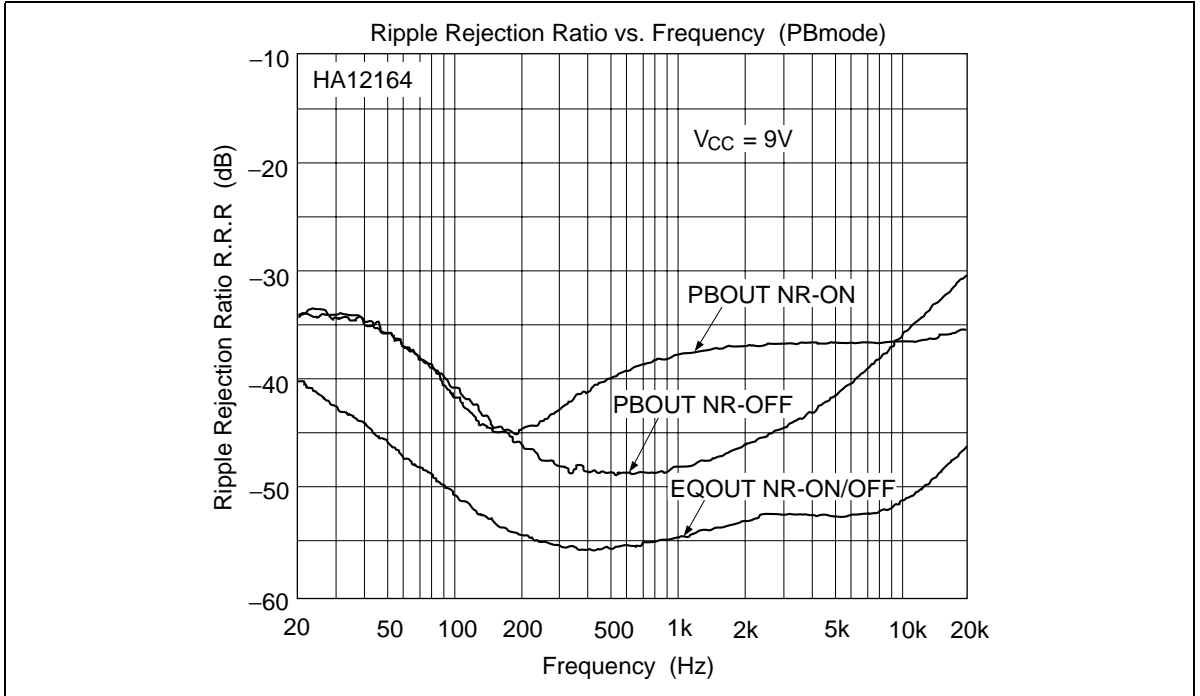

HA12165 Data

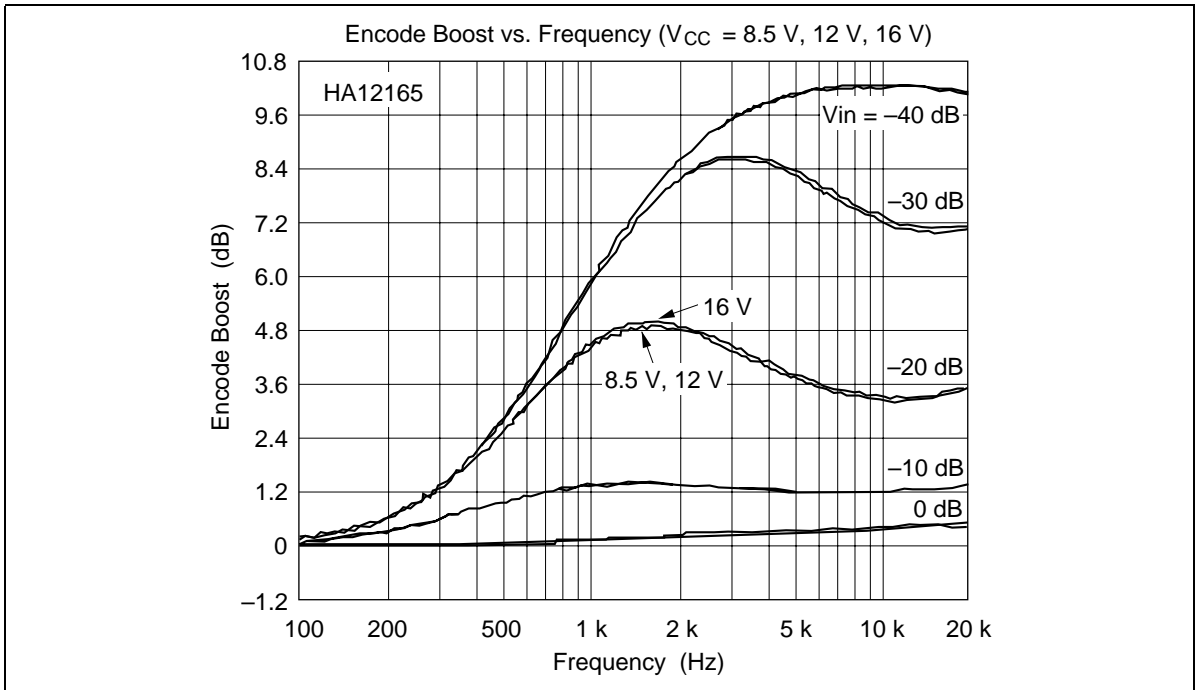

HA12163 Series

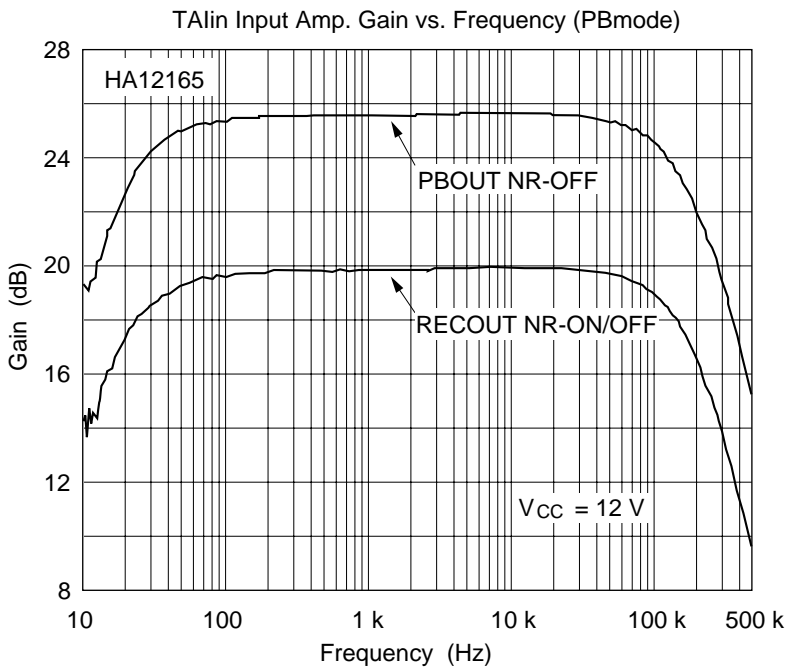
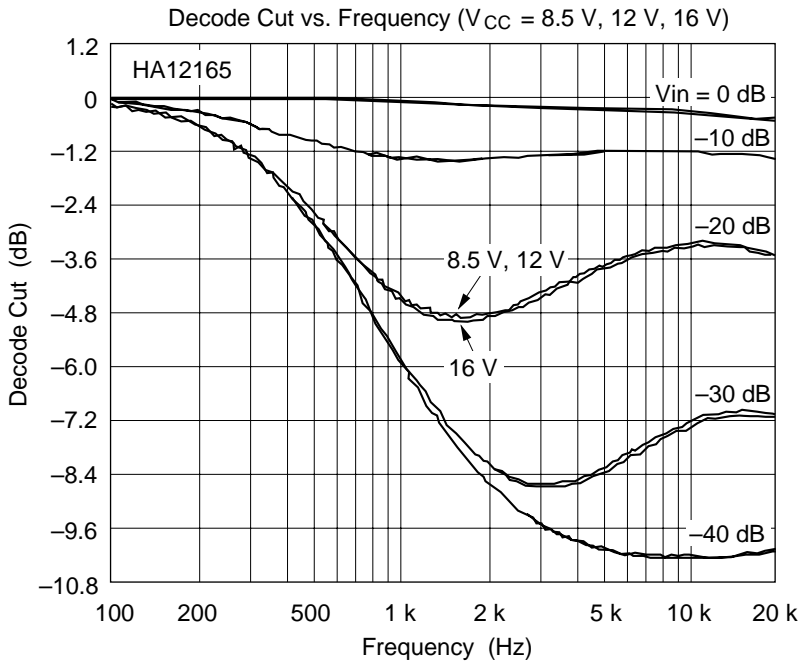

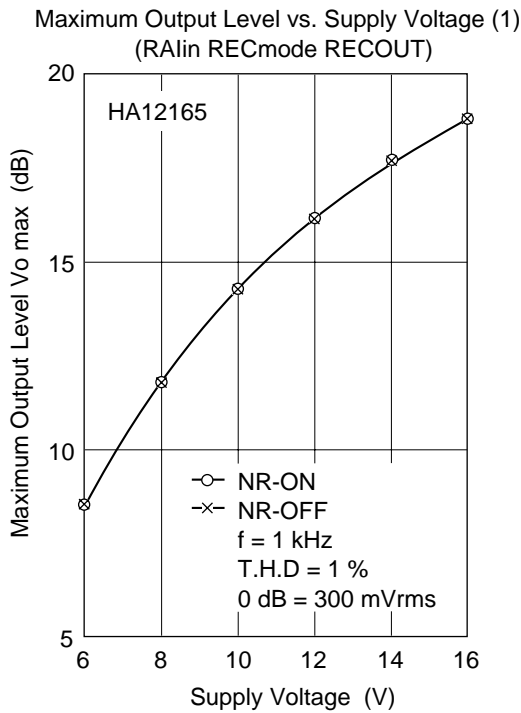
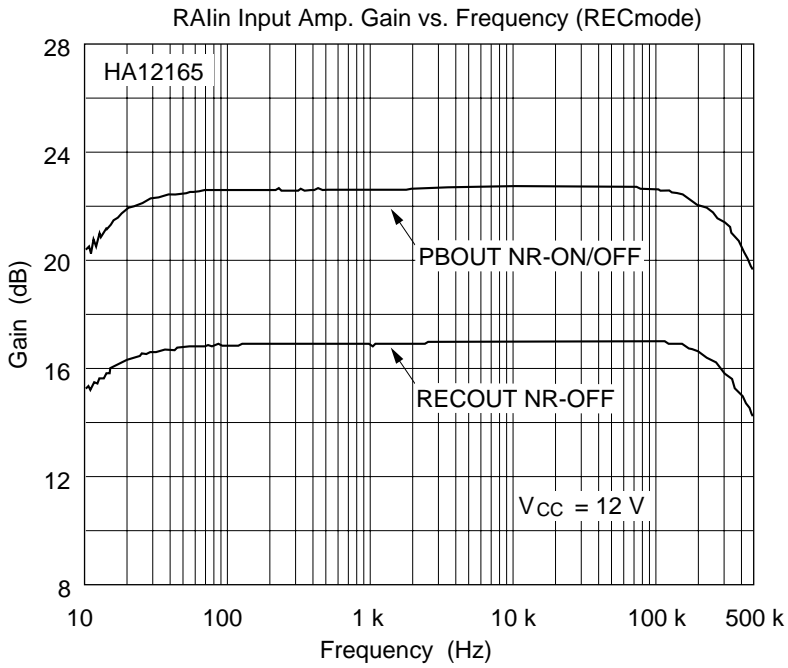

HA12163 Series

Maximum Output Level vs. Supply Voltage (2)
(RALin PBmode PBOUt)

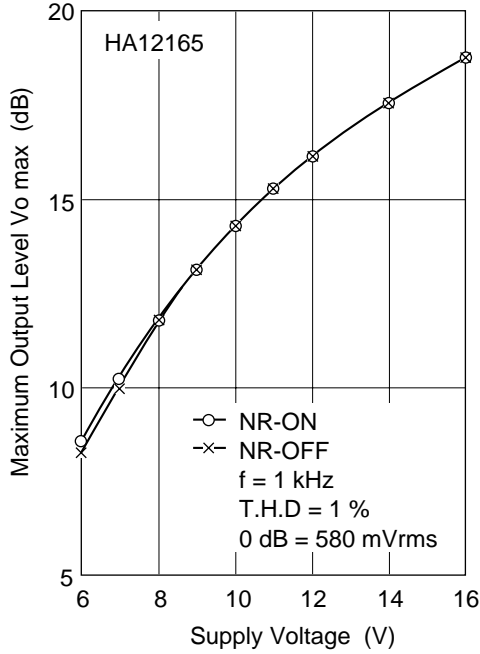

Signal to Noise Ratio vs. Supply Voltage

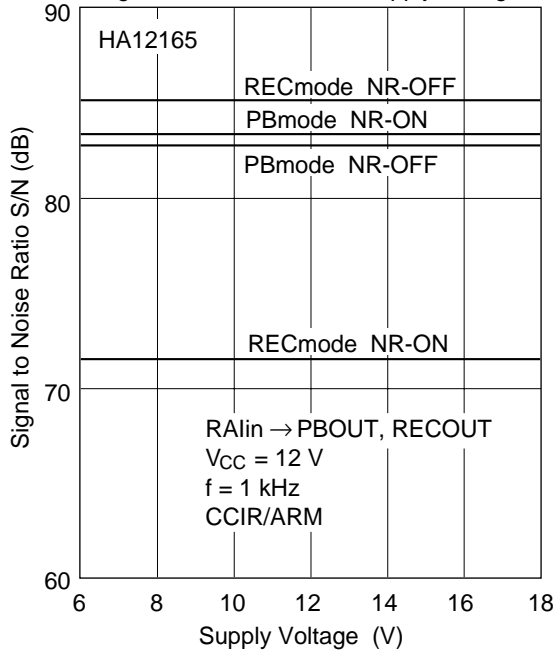

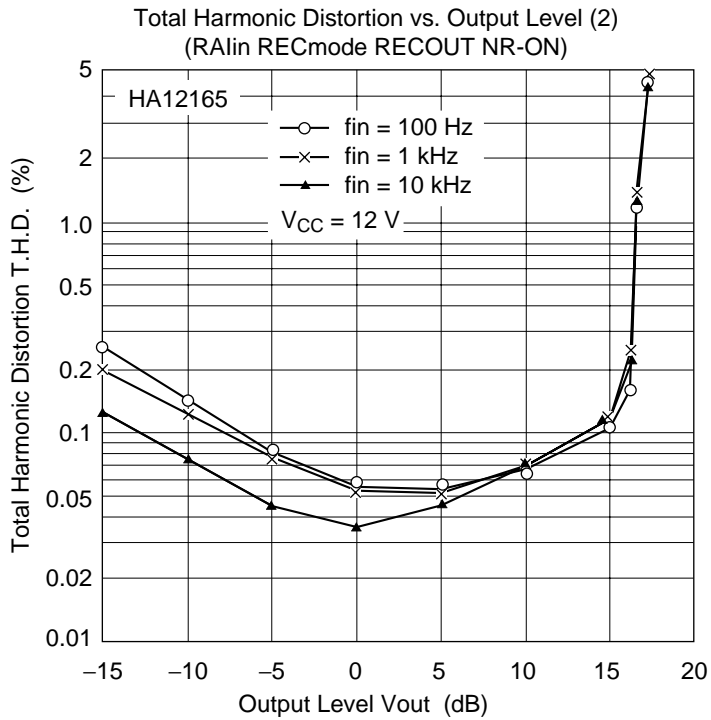
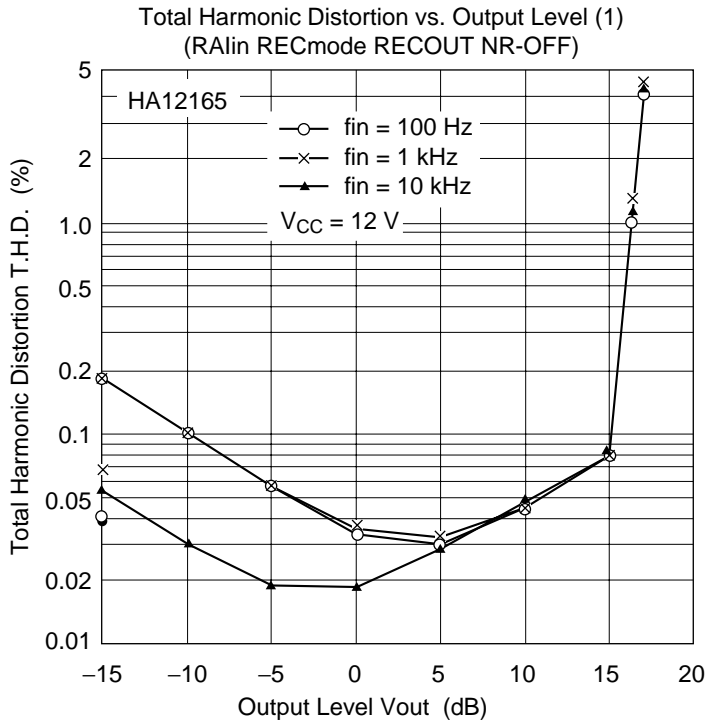

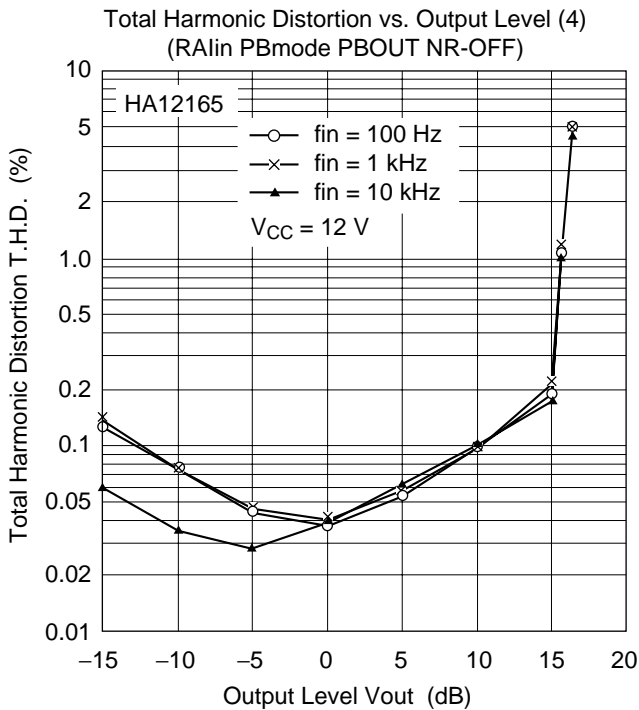
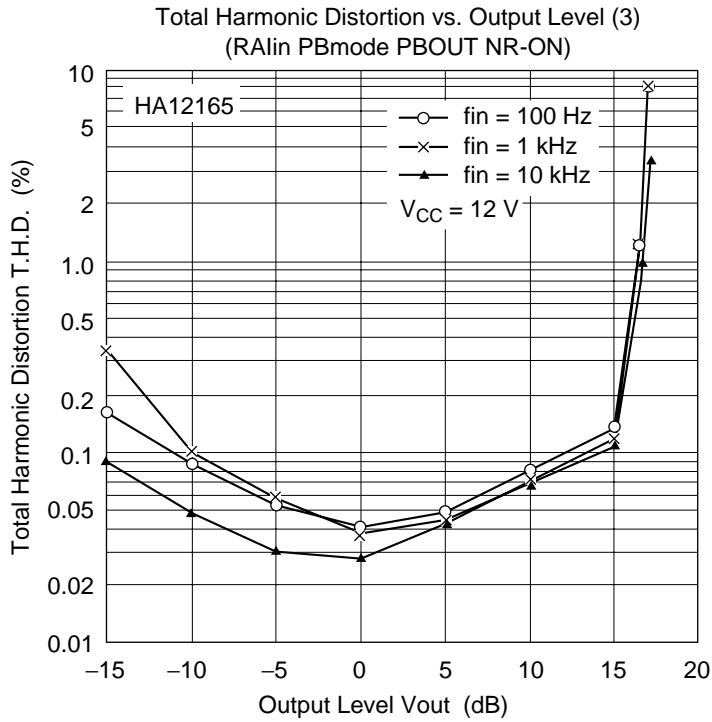

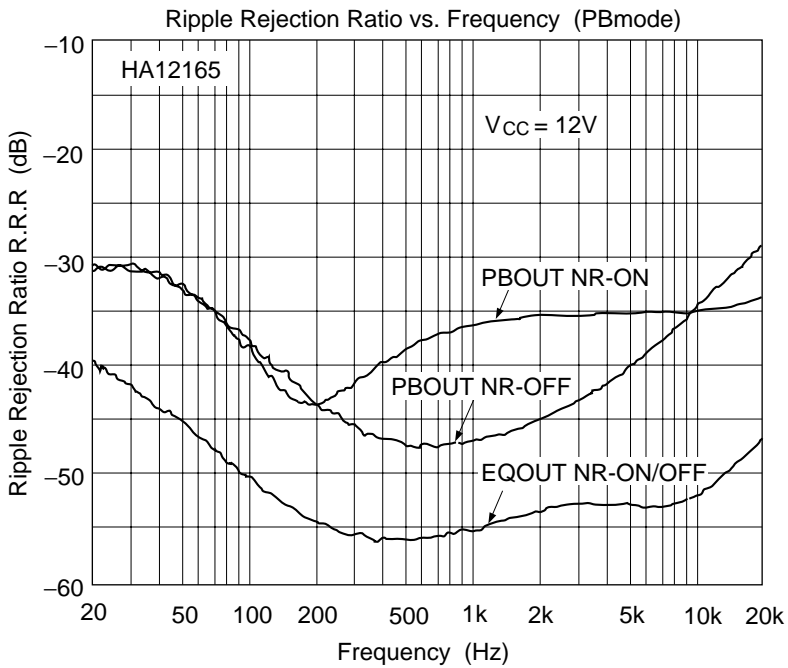
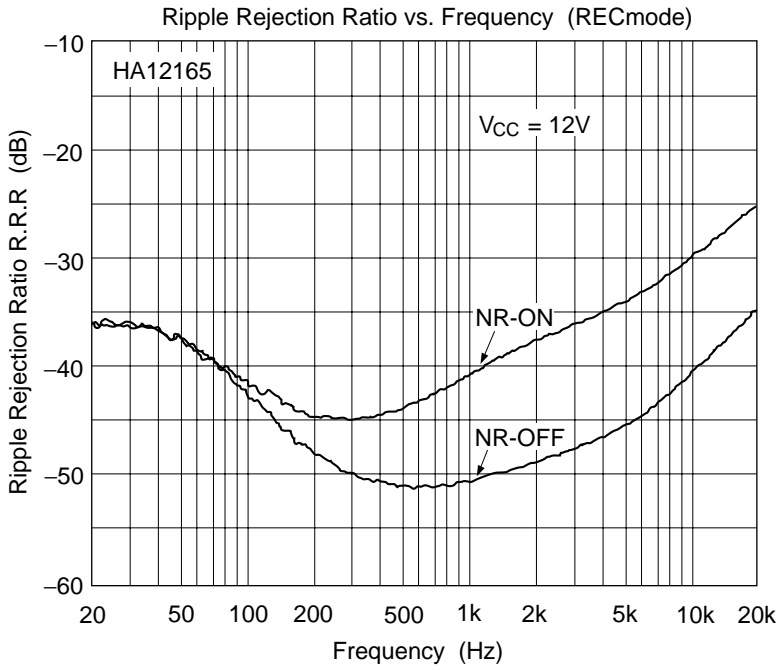

HA12163 Series

HA12160 Data

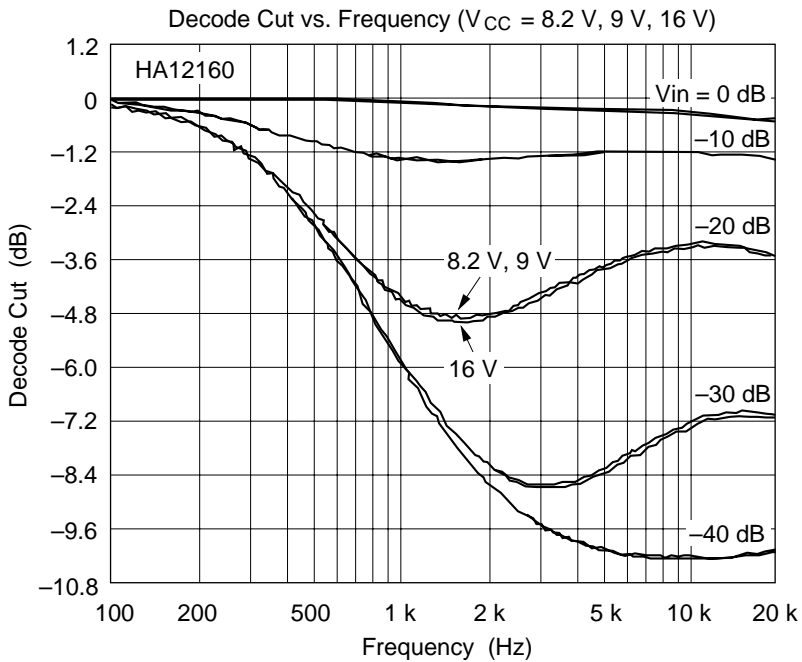
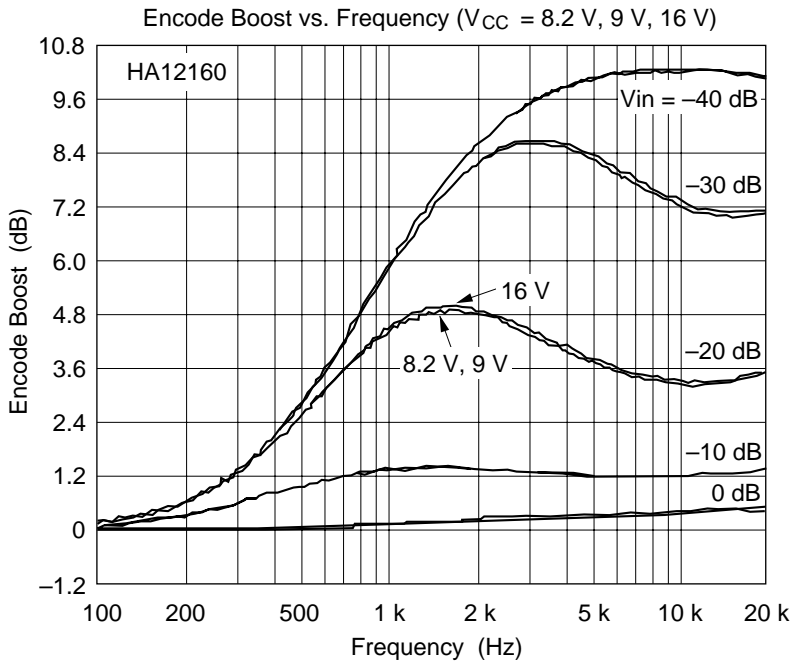

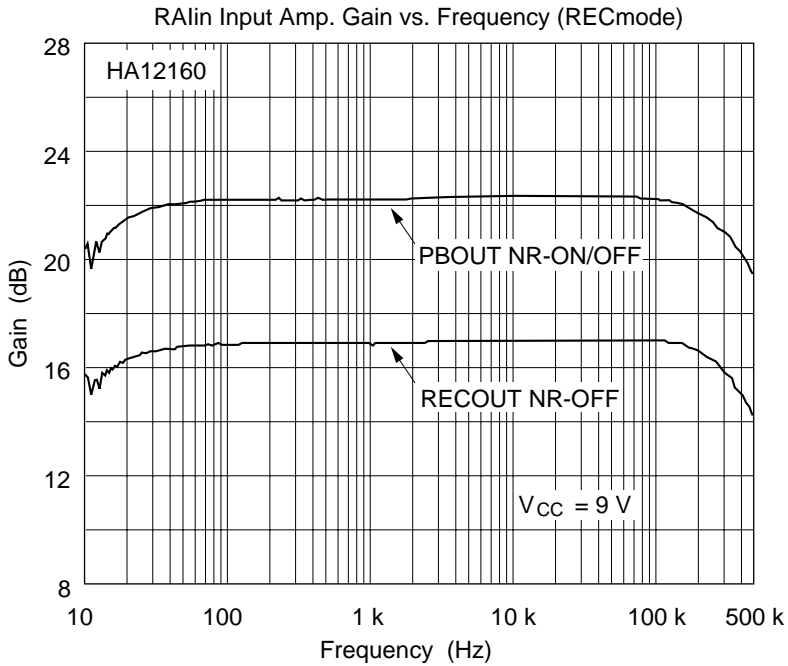
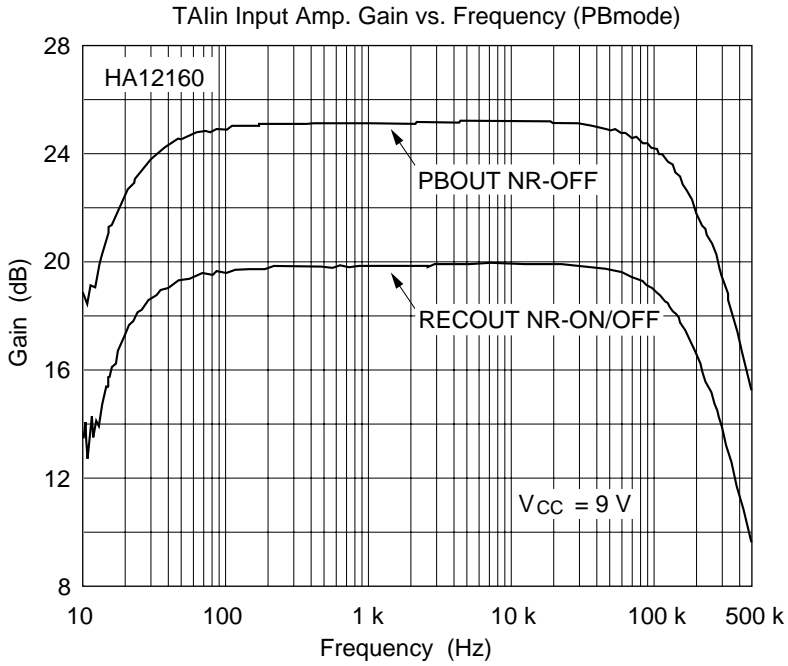

HA12163 Series

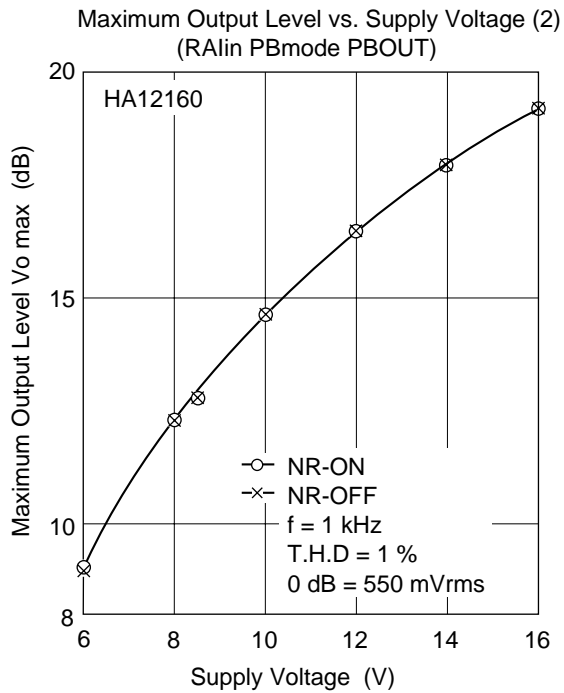
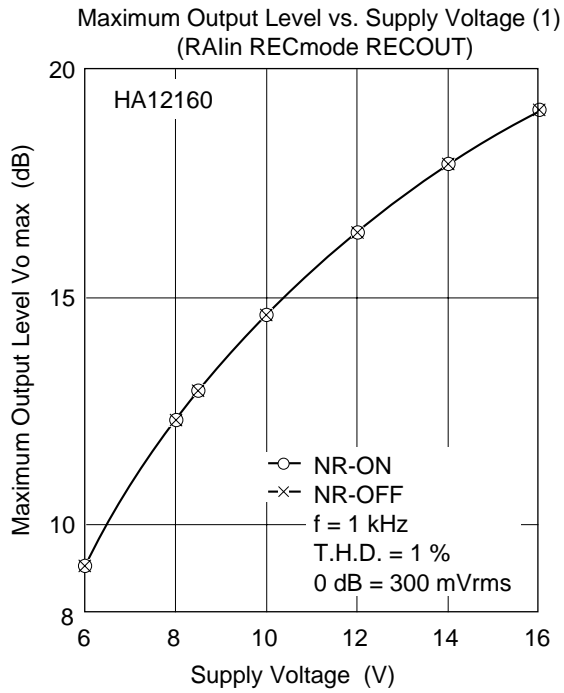

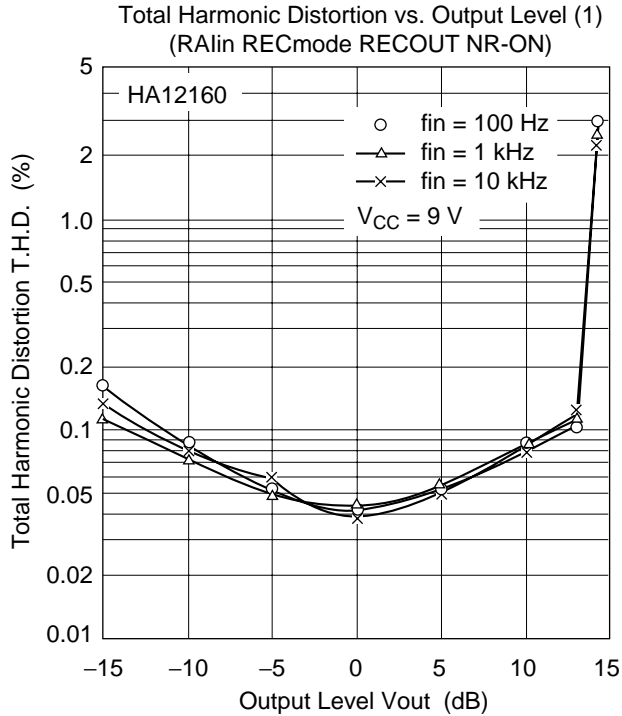
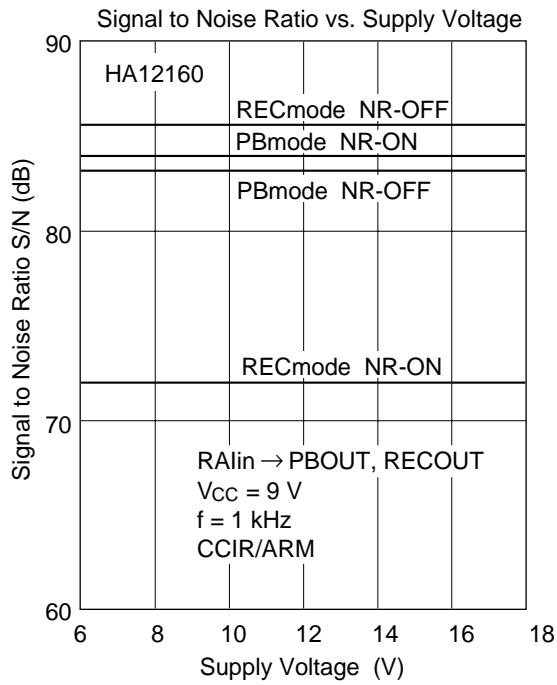

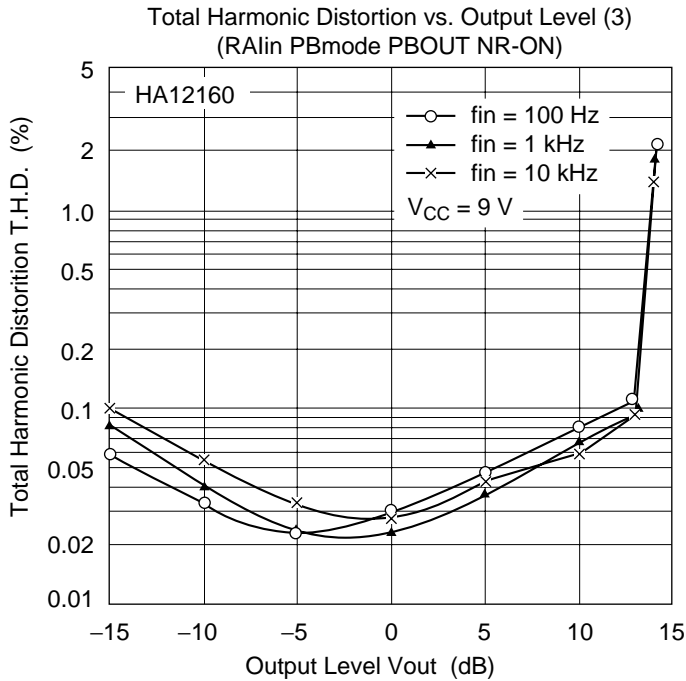
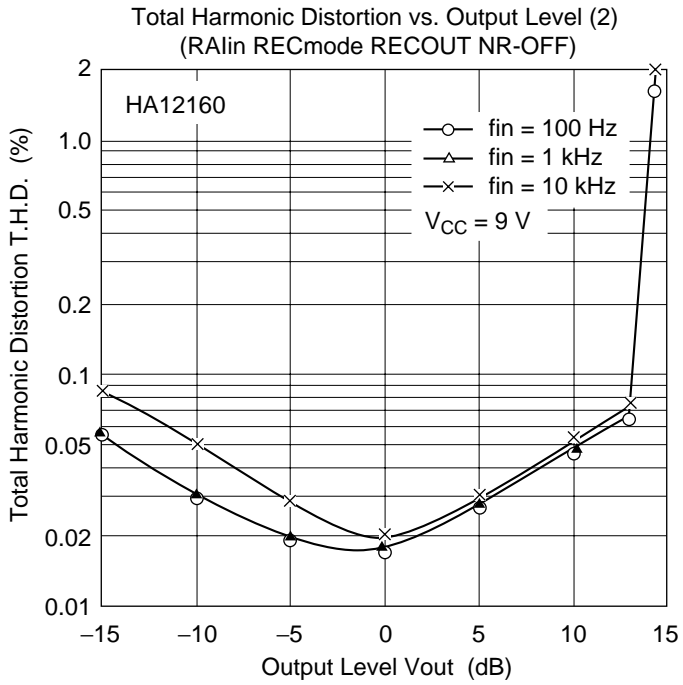

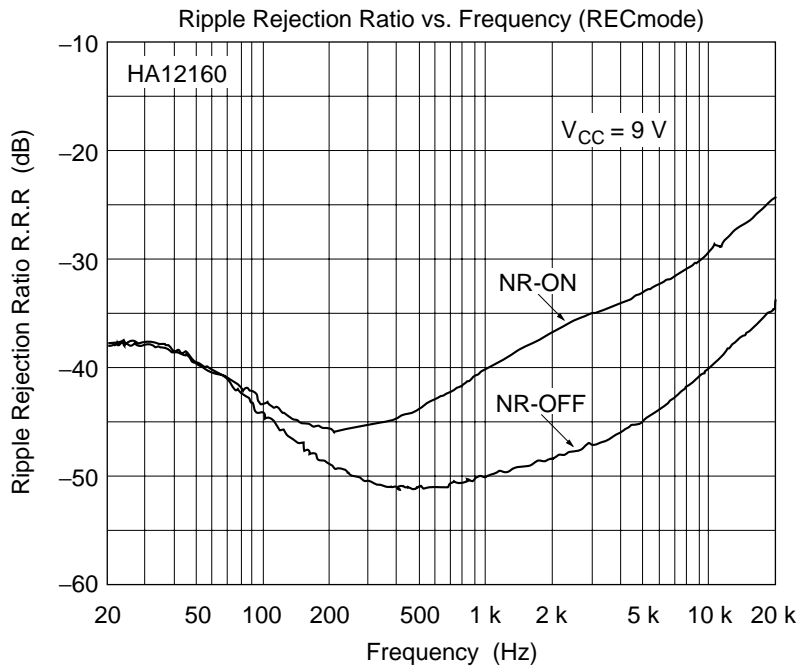
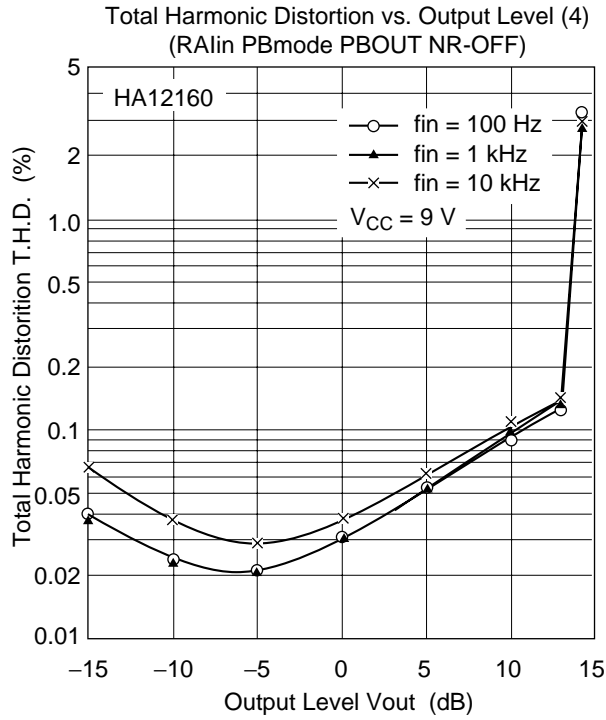

HA12163 Series

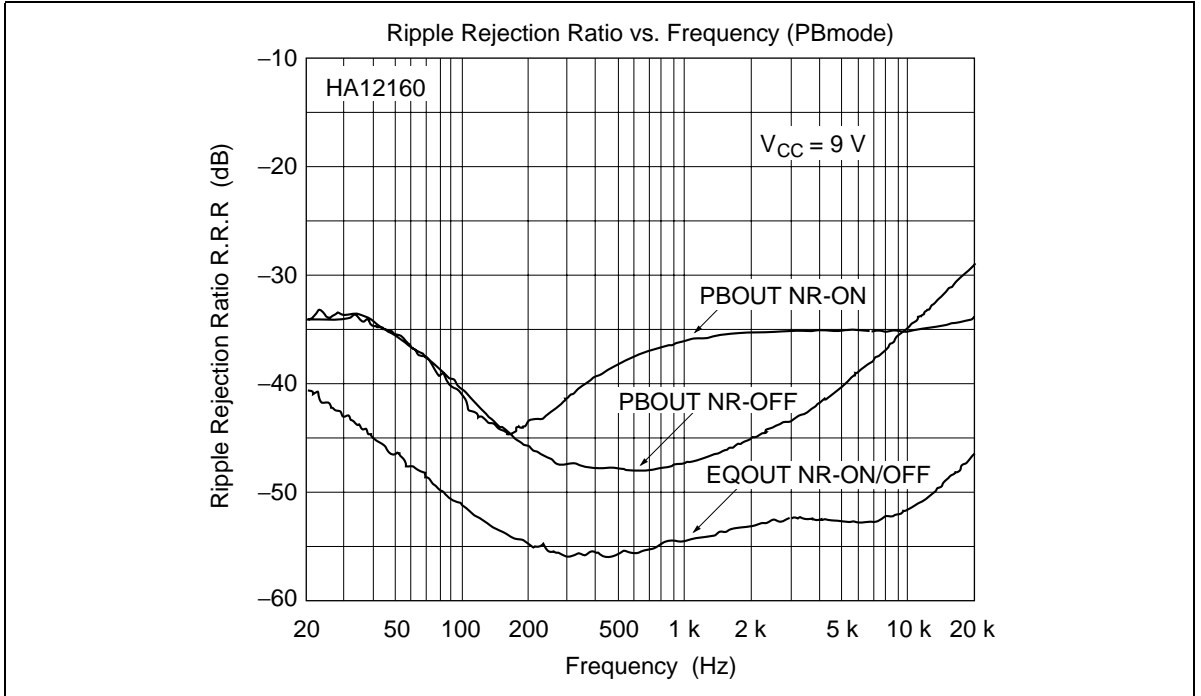

Package Dimensions

Unit: mm

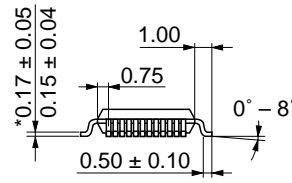
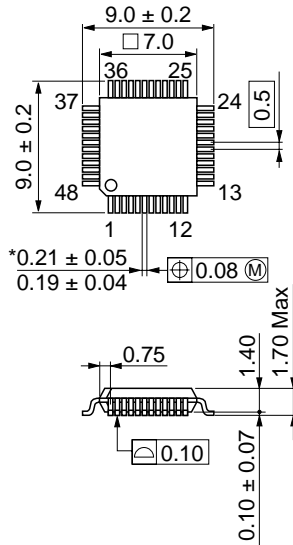

*Dimension including the plating thickness
Base material dimension

Hitachi Code	FP-48
JEDEC	—
EIAJ	Conforms
Weight (reference value)	0.2 g

Unit: mm

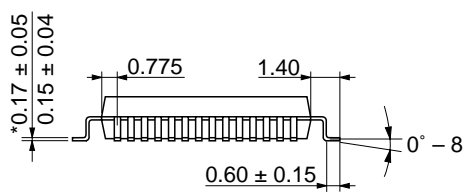
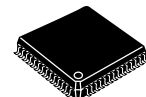
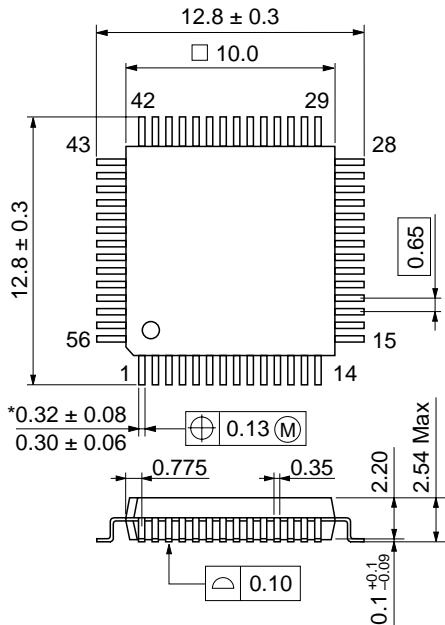

*Dimension including the plating thickness
Base material dimension

Hitachi Code	FP-56
JEDEC	—
EIAJ	—
Weight (reference value)	0.5 g

HA12163 Series

Disclaimer

1. Hitachi neither warrants nor grants licenses of any rights of Hitachi's or any third party's patent, copyright, trademark, or other intellectual property rights for information contained in this document. Hitachi bears no responsibility for problems that may arise with third party's rights, including intellectual property rights, in connection with use of the information contained in this document.
2. Products and product specifications may be subject to change without notice. Confirm that you have received the latest product standards or specifications before final design, purchase or use.
3. Hitachi makes every attempt to ensure that its products are of high quality and reliability. However, contact Hitachi's sales office before using the product in an application that demands especially high quality and reliability or where its failure or malfunction may directly threaten human life or cause risk of bodily injury, such as aerospace, aeronautics, nuclear power, combustion control, transportation, traffic, safety equipment or medical equipment for life support.
4. Design your application so that the product is used within the ranges guaranteed by Hitachi particularly for maximum rating, operating supply voltage range, heat radiation characteristics, installation conditions and other characteristics. Hitachi bears no responsibility for failure or damage when used beyond the guaranteed ranges. Even within the guaranteed ranges, consider normally foreseeable failure rates or failure modes in semiconductor devices and employ systemic measures such as fail-safes, so that the equipment incorporating Hitachi product does not cause bodily injury, fire or other consequential damage due to operation of the Hitachi product.
5. This product is not designed to be radiation resistant.
6. No one is permitted to reproduce or duplicate, in any form, the whole or part of this document without written approval from Hitachi.
7. Contact Hitachi's sales office for any questions regarding this document or Hitachi semiconductor products.

Sales Offices

HITACHI

Hitachi, Ltd.

Semiconductor & Integrated Circuits.
Nippon Bldg., 2-6-2, Ohte-machi, Chiyoda-ku, Tokyo 100-0004, Japan
Tel: Tokyo (03) 3270-2111 Fax: (03) 3270-5109

URL NorthAmerica : <http://semiconductor.hitachi.com/>
 Europe : <http://www.hitachi-eu.com/hel/ecg>
 Asia : <http://sicapac.hitachi-asia.com>
 Japan : <http://www.hitachi.co.jp/Sicd/indx.htm>

For further information write to:

Hitachi Semiconductor
(America) Inc.
179 East Tasman Drive,
San Jose, CA 95134
Tel: <1>(408) 433-1990
Fax: <1>(408) 433-0223

Hitachi Europe GmbH
Electronic Components Group
Dornacher Straße 3
D-85622 Feldkirchen, Munich
Germany
Tel: <49> (89) 9 9180-0
Fax: <49> (89) 9 29 30 00

Hitachi Europe Ltd.
Electronic Components Group.
Whitebrook Park
Lower Cookham Road
Maidenhead
Berkshire SL6 8YA, United Kingdom
Tel: <44> (1628) 585000
Fax: <44> (1628) 585160

Hitachi Asia Ltd.
Hitachi Tower
16 Collyer Quay #20-00,
Singapore 049318
Tel : <65>-538-6533/538-8577
Fax : <65>-538-6933/538-3877
URL : <http://www.hitachi.com.sg>

Hitachi Asia Ltd.
(Taipei Branch Office)
4/F, No. 167, Tun Hwa North Road,
Hung-Kuo Building,
Taipei (105), Taiwan
Tel : <886>-(2)-2718-3666
Fax : <886>-(2)-2718-8180
Telex : 23222 HAS-TP
URL : <http://www.hitachi.com.tw>

Hitachi Asia (Hong Kong) Ltd.
Group III (Electronic Components)
7/F., North Tower,
World Finance Centre,
Harbour City, Canton Road
Tsim Sha Tsui, Kowloon,
Hong Kong
Tel : <852>-(2)-735-9218
Fax : <852>-(2)-730-0281
URL : <http://www.hitachi.com.hk>

Copyright © Hitachi, Ltd., 2000. All rights reserved. Printed in Japan.
Colophon 2.0