

#### INTRODUCTION:

Adam Tech ASJ Series Stereo Jacks are a broad range of 2.6mm and 3.5mm jacks used primarily in computer and multi-media audio applications. This series provides a multitude of sizes and configurations that are available in single or multiple switching forms. Options include choice of full plastic or metal reinforced bodies, single, stacked or ganged versions and color-coded jacks for port identification.

#### FEATURES:

Broad range of sizes and configurations  
Single or Multiple switching functions  
Plastic or Metal reinforced bodies  
Ganged and Stacked versions  
Color Coded option for Port Identification

#### MATING PLUGS:

All industry standard 2.50mm and 3.50mm mono or stereo plugs.

#### SPECIFICATIONS:

##### Material:

Standard insulator: PBT or LCP, Glass reinforced, rated UL94V-0  
Optional Hi-Temp insulator: Nylon 6T, rated UL94V-0  
Insulator Color: Black  
Bushing: Brass, Nickel plated  
Contacts: Copper alloy

##### Contact Plating:

Tin over Copper underplate

##### Electrical:

Operating voltage: 12V DC max.  
Current rating: 1 Amp max.  
Contact resistance: 30 mΩ max. initial  
Insulation resistance: 100 MΩ min.  
Dielectric withstanding voltage: 500V AC for 1 minute

##### Mechanical:

Insertion force: 4.4 lbs max.  
Withdrawal force: 0.3 kg min  
Mating durability: 5000 cycles min.

##### Temperature Rating:

Operating temperature: -25°C to +85°C  
Soldering process temperature:  
Standard insulator: 235°C  
Hi-Temp insulator: 260°C

#### PACKAGING:

Anti-ESD plastic bags or Tape and Reel

#### APPROVALS AND CERTIFICATIONS:

UL Recognized & CSA Certified, File no. E224053

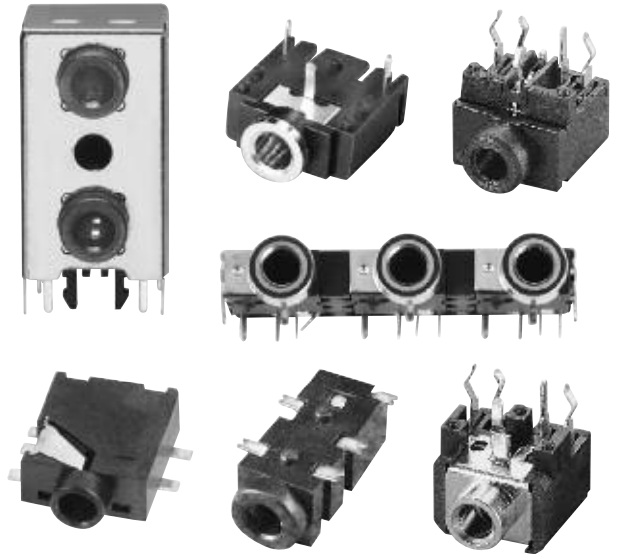

#### ORDERING INFORMATION

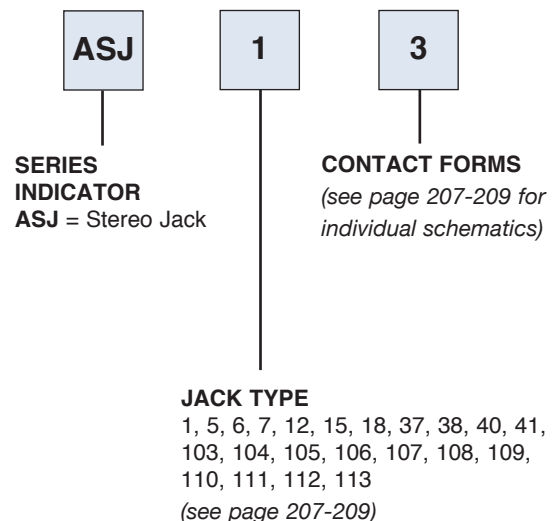

#### OPTIONS:

Add designator(s) to end of part number  
**E** = No back cover (Type 1 only)  
**M** = M6 x 0.5 threaded bushing  
**HT** = Hi-Temp Nylon 6T insulator for Hi-Temp soldering processes up to 260°C  
**TR** = Tape & Reel packaging

#### ASJ-103

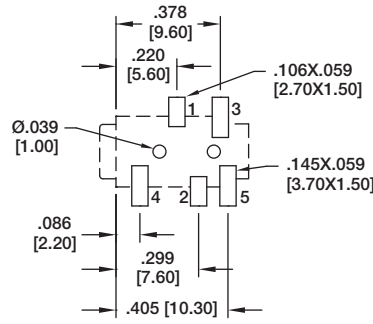
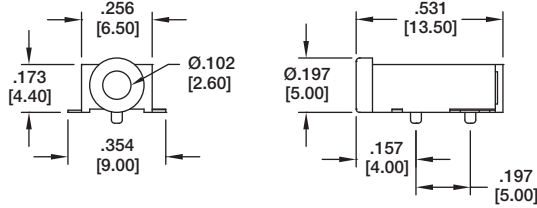

ASJ-103-J

| ASJ-103-J | ASJ-103-M |
|-----------|-----------|
|           |           |

Recommended PCB Layout

#### ASJ-104

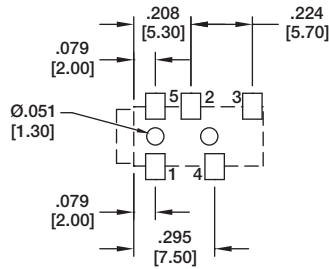
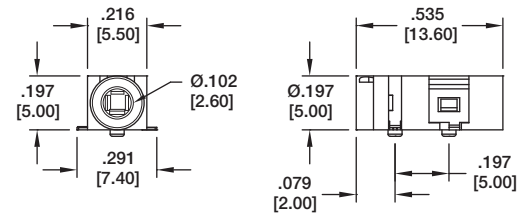

ASJ-104-J

| ASJ-104-J |
|-----------|
|           |

Recommended PCB Layout

#### ASJ-105

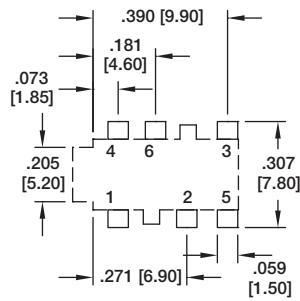
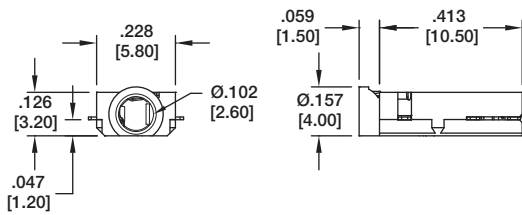

ASJ-105-A

| ASJ-105-A | ASJ-105-B |           |
|-----------|-----------|-----------|
|           |           |           |
| ASJ-105-D | ASJ-105-M | ASJ-105-I |
|           |           |           |

Recommended PCB Layout

#### ASJ-106

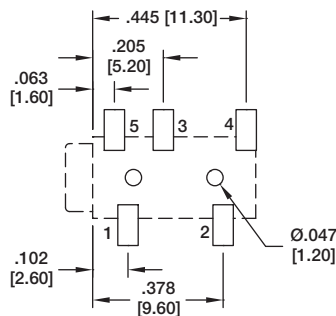
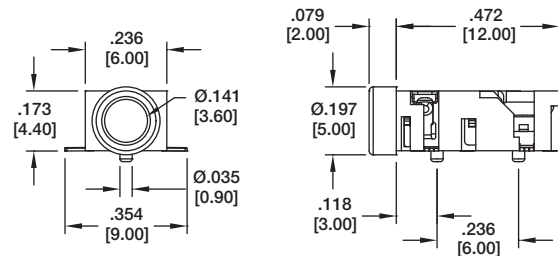

ASJ-106-C

| ASJ-106-C | ASJ-106-D |           |
|-----------|-----------|-----------|
|           |           |           |
| ASJ-106-K | ASJ-106-P | ASJ-106-B |
|           |           |           |

Recommended PCB Layout

#### ASJ-107

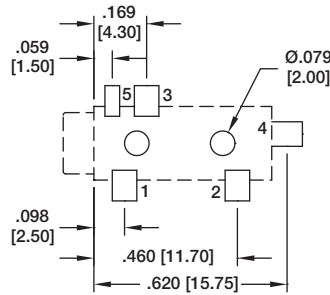
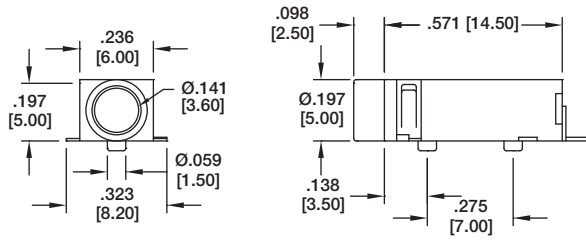

ASJ-107-B

|           |           |           |
|-----------|-----------|-----------|
|           | ASJ-107-B | ASJ-107-C |
|           |           |           |
| ASJ-107-D | ASJ-107-F | ASJ-107-A |
|           |           |           |

Recommended PCB Layout

#### ASJ-108

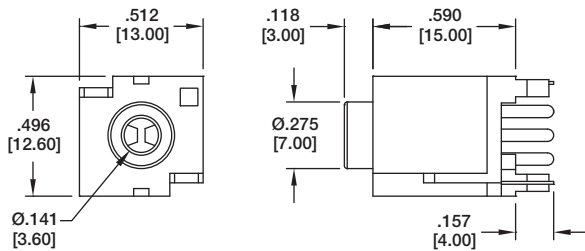

ASJ-108-A

|           |           |           |           |           |
|-----------|-----------|-----------|-----------|-----------|
| ASJ-108-A | ASJ-108-B | ASJ-108-C | ASJ-108-D | ASJ-108-G |
|           |           |           |           |           |
| ASJ-108-F | ASJ-108-L | ASJ-108-N | ASJ-108-K | ASJ-108-W |
|           |           |           |           |           |

#### ASJ-109

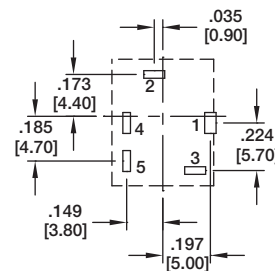
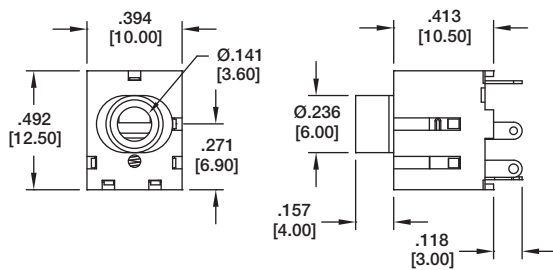

ASJ-109-A

|           |           |           |
|-----------|-----------|-----------|
| ASJ-109-A | ASJ-109-B | ASJ-109-D |
|           |           |           |

Recommended PCB Layout

#### ASJ-110

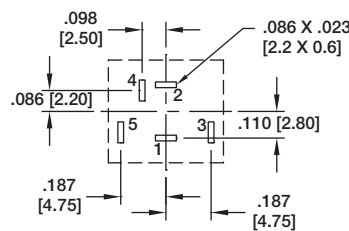
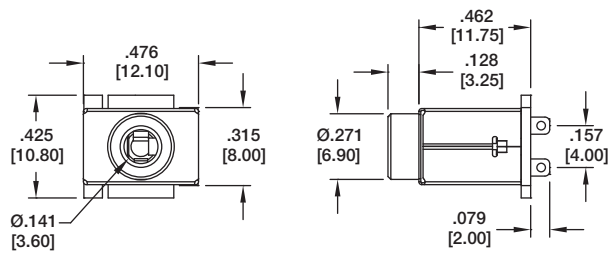

ASJ-110-A

|           |
|-----------|
| ASJ-110-L |
|           |

Recommended PCB Layout

#### ASJ-111

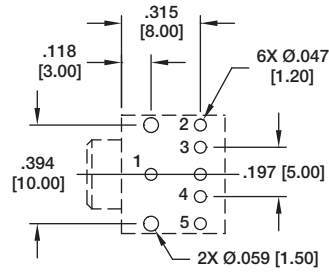
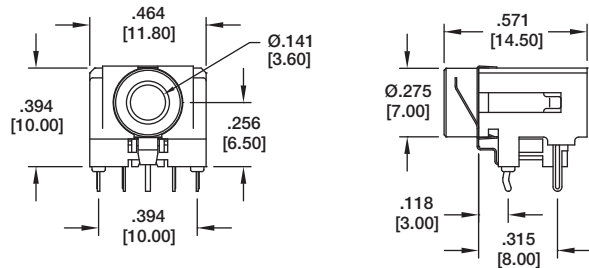

Recommended PCB Layout

ASJ-111-1

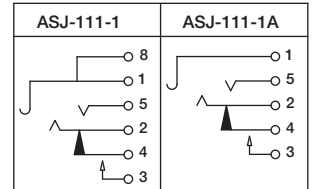

#### ASJ-112



ASJ-112-J

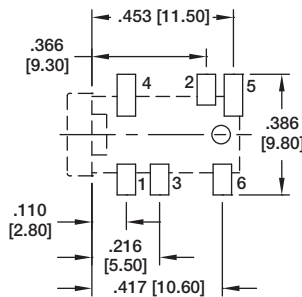
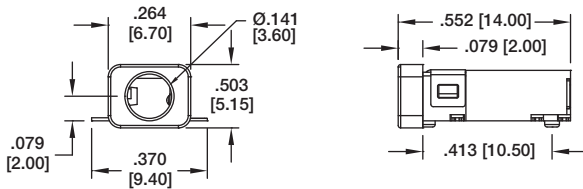

Recommended PCB Layout

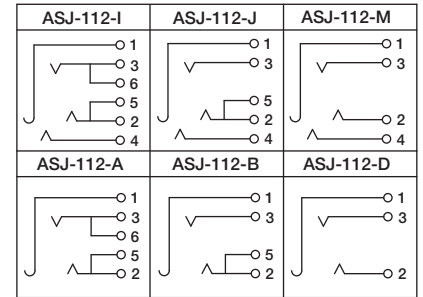

#### ASJ-113



ASJ-113-B

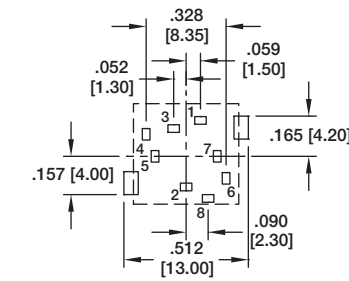
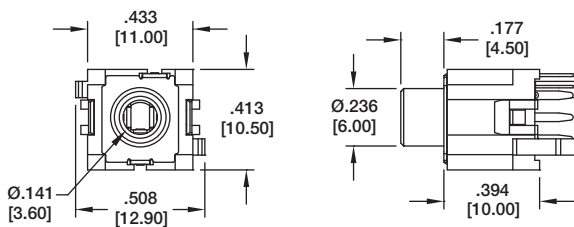

Recommended PCB Layout

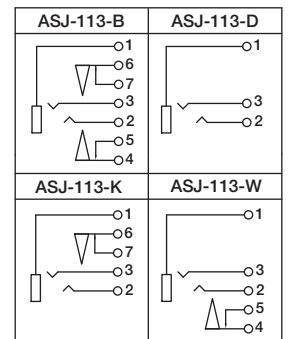

#### MONO AUDIO PLUG

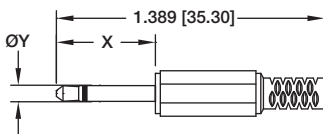

| DIMENSION | X            | Y            |
|-----------|--------------|--------------|
| ASP-2.5-M | .468 [11.90] | Ø.098 [2.50] |
| ASP-3.5-M | .590 [15.00] | Ø.137 [3.50] |

#### STEREO AUDIO PLUG

##### 2 CHANNEL

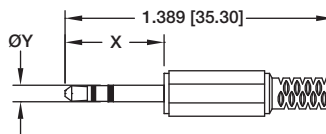

| DIMENSION | X            | Y            |
|-----------|--------------|--------------|
| ASP-2.5-S | .468 [11.90] | Ø.098 [2.50] |
| ASP-3.5-S | .590 [15.00] | Ø.137 [3.50] |

#### STEREO AUDIO PLUG

##### 3 CHANNEL

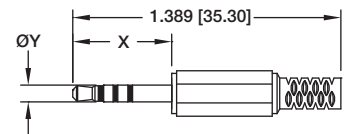

| DIMENSION  | X            | Y            |
|------------|--------------|--------------|
| ASP-2.5-S3 | .468 [11.90] | Ø.098 [2.50] |
| ASP-3.5-S3 | .590 [15.00] | Ø.137 [3.50] |