

36.0-42.0 GHz GaAs Transmitter SMT, 7x7 mm



April 2009 - Rev 15-Apr-09

X UI006-QB
X RoHS

Features

- X Sub-harmonic, Image Reject Transmitter
- X Integrated Mixer, LO Doubler/Buffer & Output Amplifier
- X +17.0 dBm Output Third Order Intercept (OIP3)
- X +2.0 dBm LO Drive Level
- X 2.0 dB Conversion Gain
- X 7x7mm SMT Package
- X 100% RF and DC Testing



General Description

Mimix Broadband's 36.0-42.0 GHz GaAs transmitter has a +17.0 dBm output third order intercept across the band. This device is a balanced, resistive pHEMT mixer followed by a distributed output amplifier and includes an integrated LO doubler and LO buffer amplifier. The use of integrated LO doubler and LO buffer amplifier makes the provision of the LO easier than for fundamental mixers at these frequencies. I and Q mixer inputs are provided and an external 90 degree hybrid is required to select the desired sideband. The device comes in a 7x7mm SMT package that is RoHS compliant. This device is well suited for Millimeter-wave Point-to-Point Radio, LMDS, SATCOM and VSAT applications.

Absolute Maximum Ratings

Supply Voltage (Vd)	+6.0 VDC
Supply Current (Id)	350 mA
Gate Bias Voltage (Vg)	+0.3 VDC
Input Power (Pin)	+0.0 dBm
Storage Temperature (Tstg)	-65 to +165 deg C
Operating Temperature (Ta)	-55 to MTTF Table ¹
Channel Temperature (Tch)	MTTF Table ¹
ESD - Human Body Model	Class 1A
ESD - Machine Body Model	Class M1
Moisture Sensitivity Level	MSL3

(1) Channel temperature affects a device's MTTF. It is recommended to keep channel temperature as low as possible for maximum life

Electrical Characteristics (Ambient Temperature T = 25° C)

Parameter	Units	Min.	Typ.	Max.
Frequency Range (RF) Upper Side Band	GHz	36.0	-	42.0
Frequency Range (RF) Lower Side Band	GHz	36.0	-	42.0
Frequency Range (LO)	GHz	16.0	-	26.0
Frequency Range (IF)	GHz	DC	-	4.0
Output Return Loss RF (S22)	dB	-	10.0	-
Small Signal Conversion Gain IF/RF (S21)	dB	0.0	2.0	4.0
LO Input Drive (P _{LO})	dBm	+2.0	+4.0	-
Leakage @ RF Port LOx1	dBm	-	-25.0	-
Leakage @ RF Port LOx2	dBm	-	-15.0	-12.0
Input Third Order Intercept (IIP3)	dBm	10.0	13.0	-
Attenuation Range	dB	25.0	28.0	-
Drain Bias Voltage (Vd)	VDC	-	+4.0	-
Gate Bias Voltage (Vg1)	VDC	-	-0.3	-
Gate Bias Voltage (Vg2) Mixer, Doubler	VDC	-	-0.5	-
Dynamic Range Control (Vc)	VDC	-2.0	-	0.0
Supply Current (Id) (Vd=4.0V)	mA	-	240	-
Supply Current (Ic)	mA	-	0.0	-

36.0-42.0 GHz GaAs Transmitter SMT, 7x7 mm



April 2009 - Rev 15-Apr-09

XU1006-QB
RoHS

Transmitter Measurements

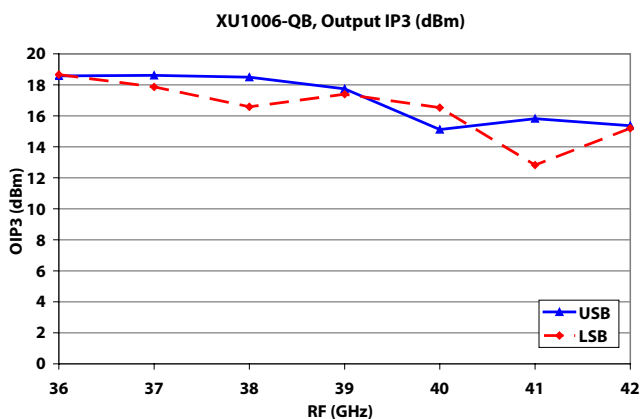
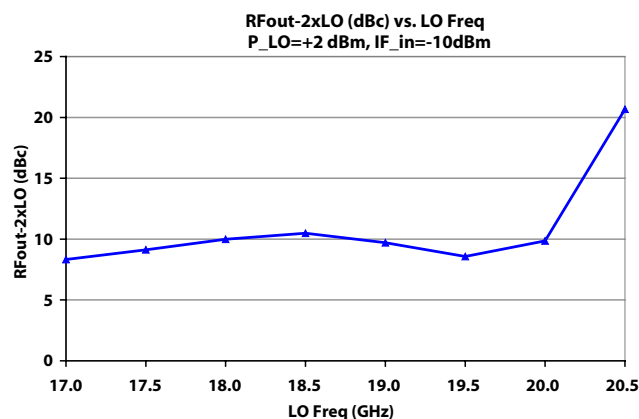
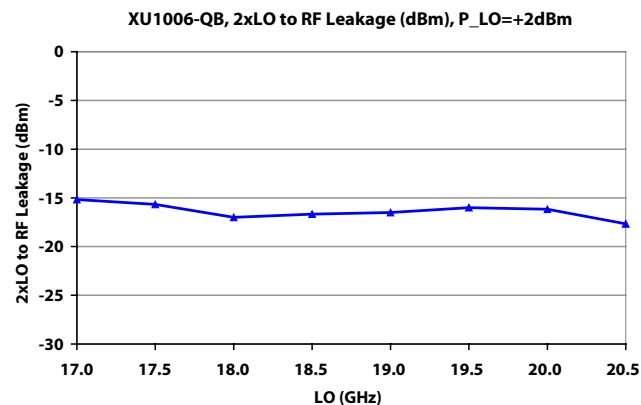
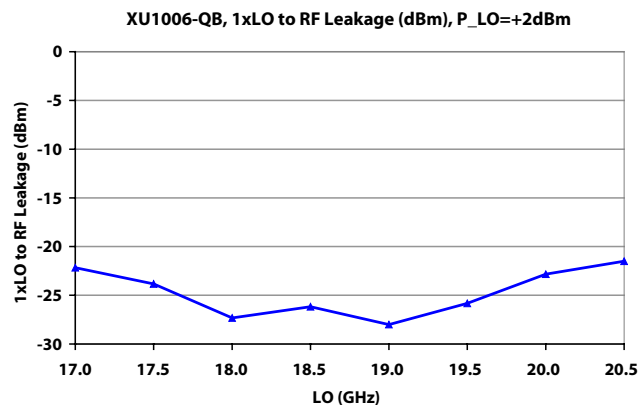
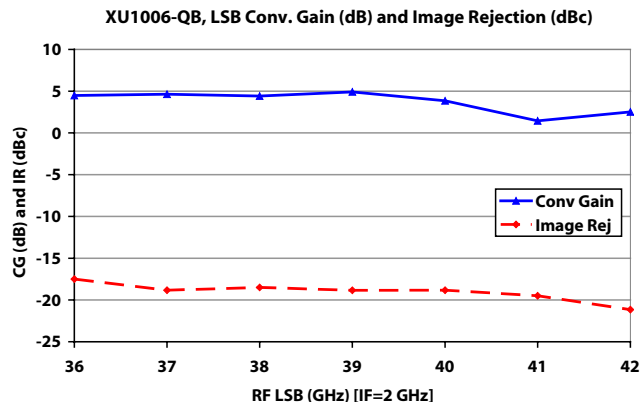
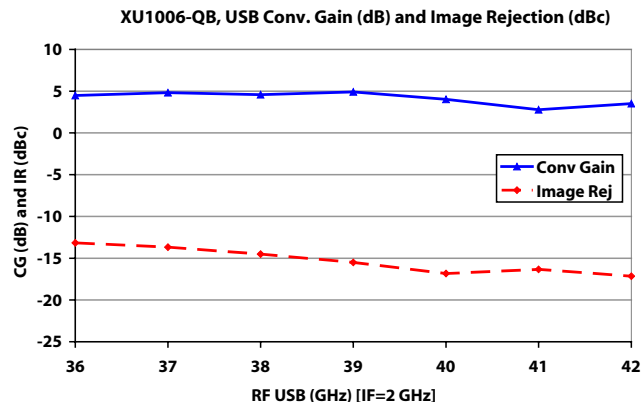

36.0-42.0 GHz GaAs Transmitter SMT, 7x7 mm

Transmitter Measurements (cont.)

XU1006-QB, Input IP3 (dBm)

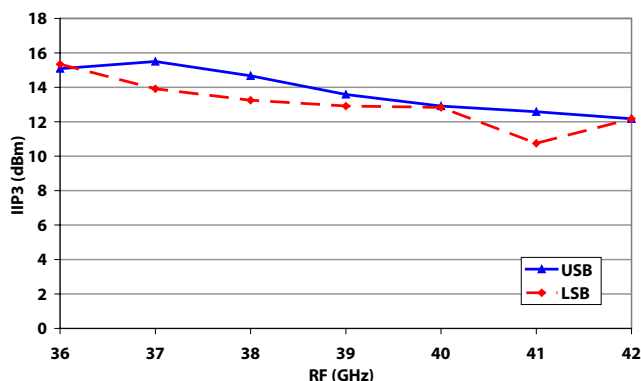

XU1006-QB, Conv Gain and IIP3 vs Vc (Dynamic Range)
RF=38GHz, IF=2GHz, P_IF=-3dBm/tone

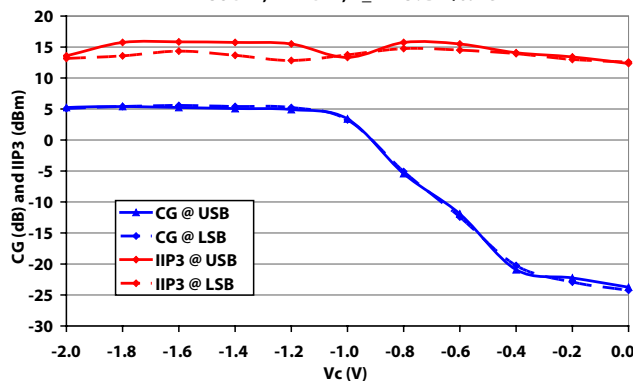

USB Conversion Gain Vs Control Voltage (Vc), 38GHz
Vg2=-0.5V, Vd=4V, Id=240mA, P_LO=+4dBm

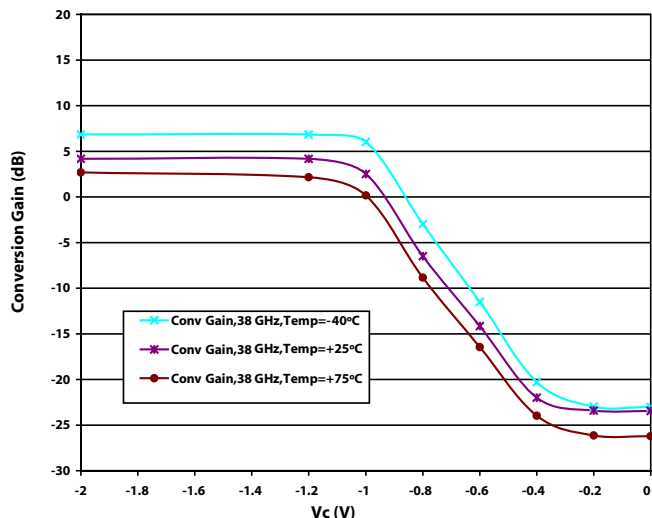

USB Conversion Gain Vs Control Voltage (Vc), 36GHz
Vg2=-0.5V, Vd=4V, Id=240mA, P_LO=+4dBm

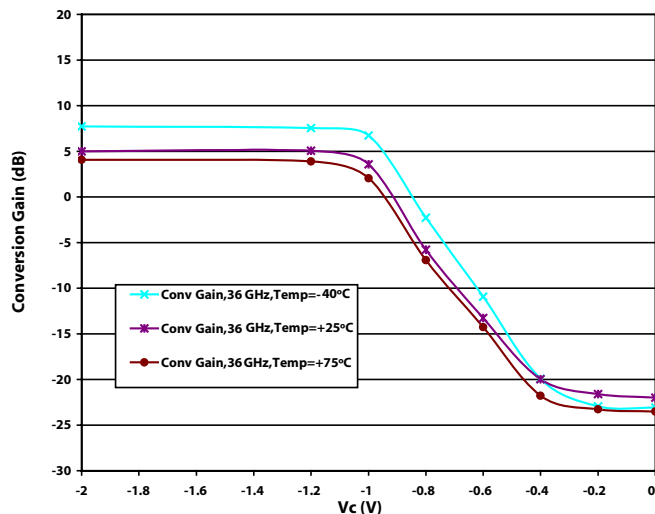

LSB IIP3 for XU1006-QB
Vg2=-0.5V, Vd=4V, Id=240mA, P_LO=+4dBm, P_IF/1tone=-5dBm, ?F=10 MHz

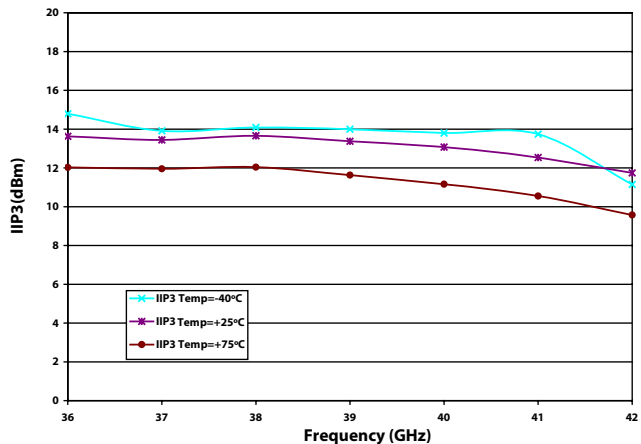

USB IIP3 for XU1006-QB
Vg2=-0.5V, Vd=4V, Id=240mA, P_LO=+4dBm, P_IF/1tone=-5dBm, ?F=10 MHz

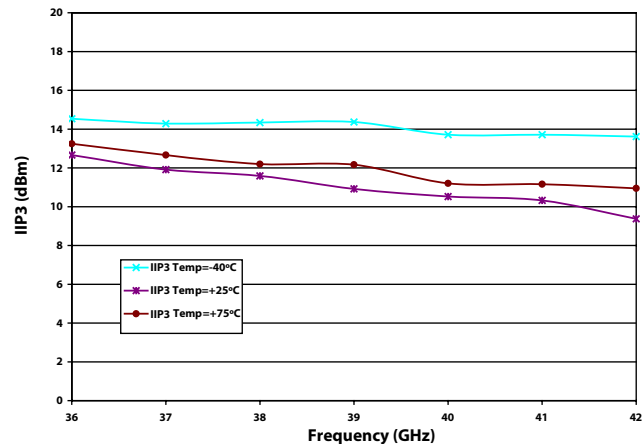

36.0-42.0 GHz GaAs Transmitter SMT, 7x7 mm



April 2009 - Rev 15-Apr-09

X UI006-QB
X RoHS

Transmitter Measurements (cont.)

(x2)LO Leakage for XU1006-QB
Vg2=-0.5V, Vd=4V, Id=240mA, P_LO=+4dBm, P_IF=-10dBm, IF_Frequency=2 GHz

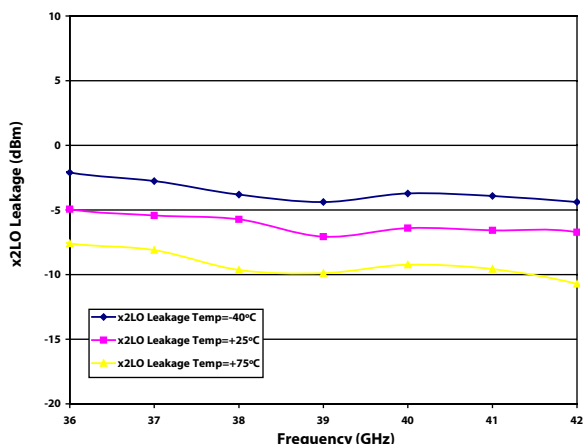

LSB Conversion Gain (dB) and IR (dBc) for XU1006-QB
Vg2=-0.5V, Vd=4V, Id=240mA, P_LO=+4dBm, P_IF=-10dBm, IF_Frequency=2 GHz

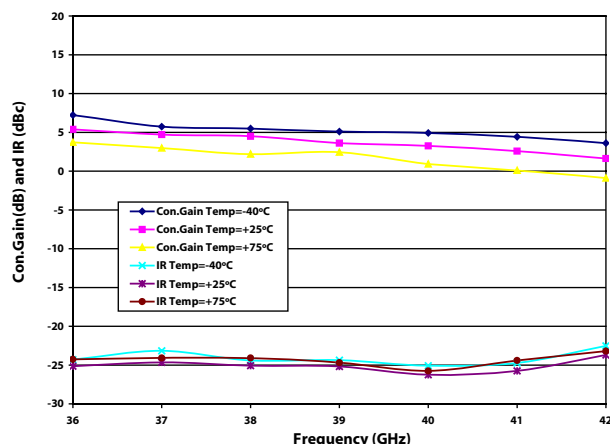

USB Conversion Gain (dB) and IR (dBc) for XU1006-QB
Vg2=-0.5V, Vd=4V, Id=240mA, P_LO=+4dBm, P_IF=-10dBm, IF_Frequency=2 GHz

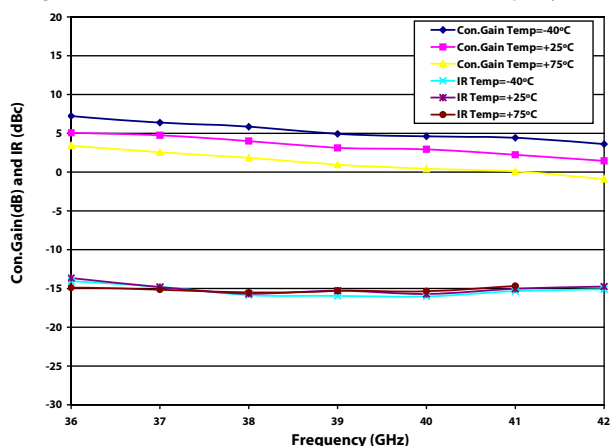

36.0-42.0 GHz GaAs Transmitter

SMT, 7x7 mm

Physical Dimensions

QB - MSL, Gross Leak Test Compliant

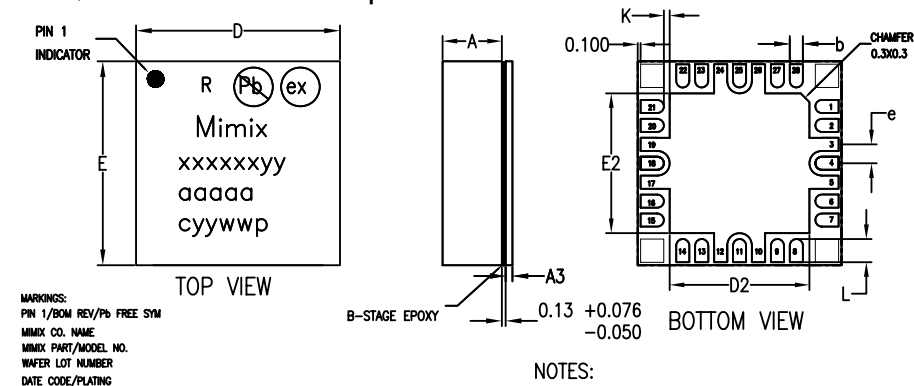

RECOMMENDED SOLDER PAD PITCH AND DIMENSIONS

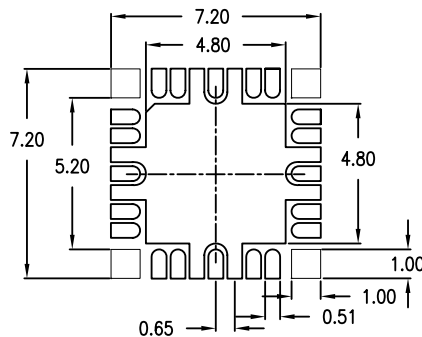

	MIN	TYP	MAX
A	1.20	1.25	1.30
A3	0.10 - 0.20 REF		
b	0.40	0.45	0.50
K	-	0.20	-
D	7.00 BSC		
E	7.00 BSC		
e	0.65		
D2	4.75	4.80	4.85
E2	4.75	4.80	4.85
L	0.75	0.80	0.85

1. VIEWS ARE NOT TO SCALE: USE DIMENSIONS AND TABLE.

Functional Schematic

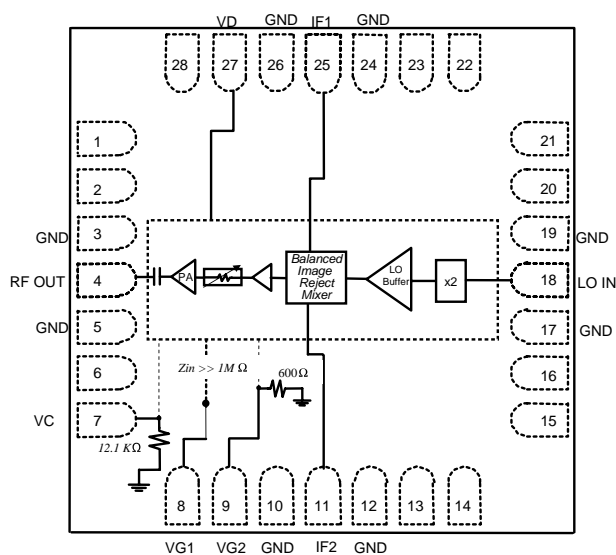

Package Pin-out Table

Pin Number	Pin Name	Pin Function	Nominal Value	Unit
4	RF Out	RF Out		
7	VC	Gain Control	-2.0 to 0.0	Volts
8	VG1	LNA, LO Amp	-0.4	volts
9	VG2	Mixer, Doubler	-0.5	volts
11	IF2	IF2 Input		
18	LO IN	LO Input	+2.0	dBm
25	IF1	IF1 Input		
27	VD1	Drain Bias	+4.0	volts
All other pins	GND	Ground		

36.0-42.0 GHz GaAs Transmitter SMT, 7x7 mm

April 2009 - Rev 15-Apr-09

Recommended Layout

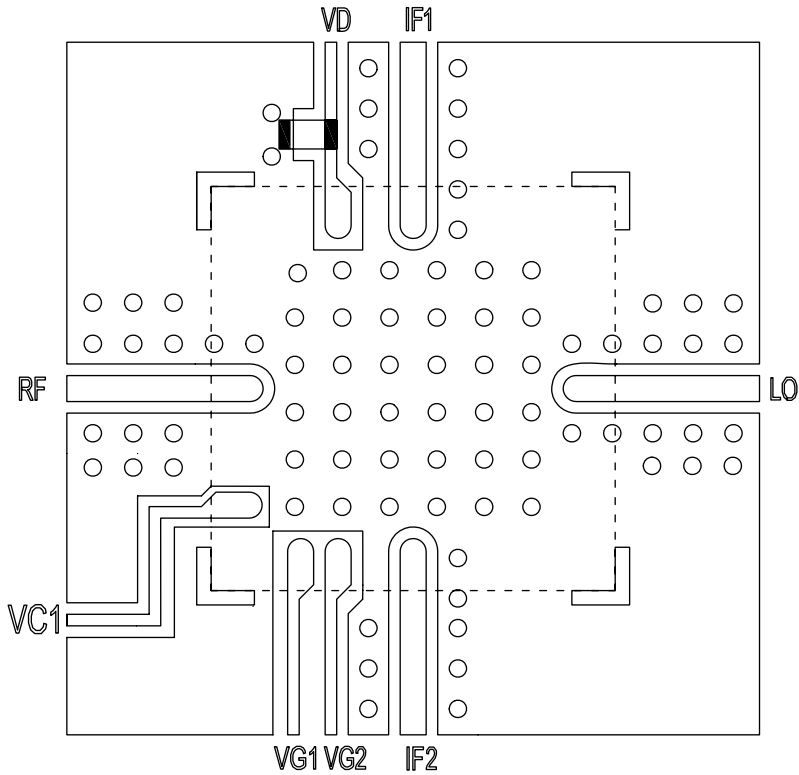

Environmental

MSL - Gross Test Leak Compliant

36.0-42.0 GHz GaAs Transmitter SMT, 7x7 mm

App Note [1] Biasing - App Note [1] Biasing - The device is operated by biasing $V_D=4.0V$ with $I_D=240mA$. Additionally, a mixer and doubler bias are also required with $V_{G2} = -0.5V$. Adjusting V_{g2} above or below this value can adversely affect conversion gain, image rejection and intercept point performance. The VC bias pin controls an integrated attenuator where $V_C=-1.3V$ provides the minimum attenuation and $V_C = 0.0V$ provides the maximum attenuation (approximately 25 dB).

It is recommended to use active biasing to keep the currents constant as the RF power and temperature vary; this gives the most reproducible results. Depending on the supply voltage available and the power dissipation constraints, the bias circuit may be a single transistor or a low power operational amplifier, with a low value resistor in series with the drain supply used to sense the current. The gate of the pHEMT is controlled to maintain correct drain current and thus drain voltage. The typical gate voltage needed to do this is $V_{G1} = -0.4V$. Typically the gate is protected with Silicon diodes to limit the applied voltage. Also, make sure to sequence the applied voltage to ensure negative gate bias is available before applying the positive drain supply.

MTTF

MTTF is calculated from accelerated life-time data of single devices and assumes an isothermal back-plate.

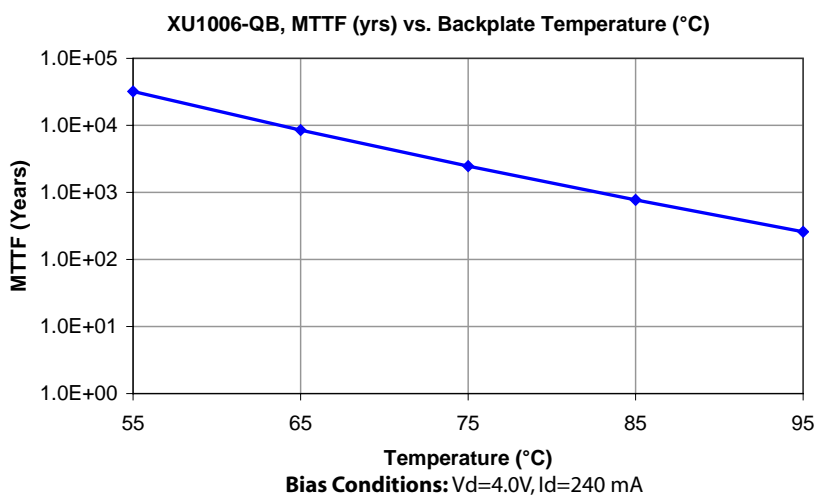

Typical Application

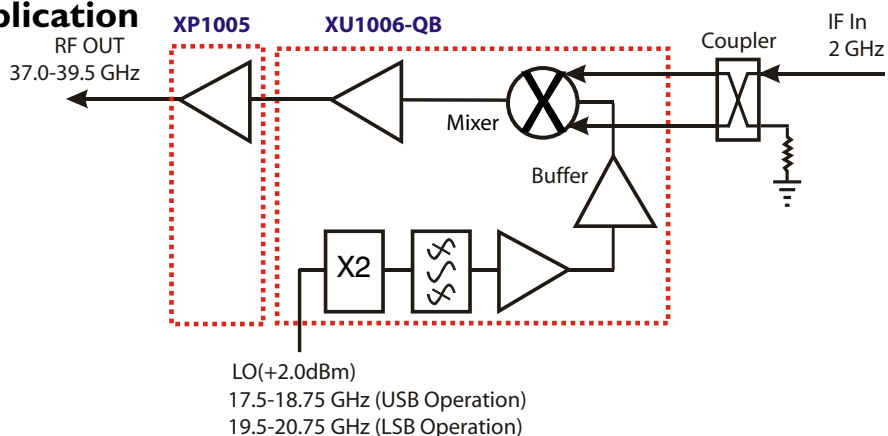

Mimix Broadband MMIC-based 35.0-45.0 GHz Transmitter Block Diagram

(Changing LO and IF frequencies as required allows design to operate as high as 42 GHz)

Mimix Broadband's 36.0-42.0 GHz XU1006-QB GaAs Transmitter can be used in saturated radio applications and linear modulation schemes up to 128 QAM. The transmitter can be used in upper and lower sideband applications from 36.0-42.0 GHz.

36.0-42.0 GHz GaAs Transmitter SMT, 7x7 mm

App Note [3] USB/LSB Selection -

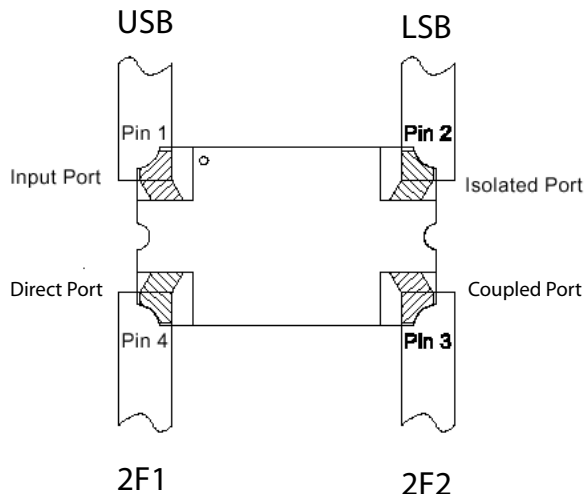

For Upper Side Band operation (USB):

With IF1 and IF2 connected to the direct port (0°) and coupled port (-90°) respectively as shown in the diagram, the USB signal will reside on the input port. The isolated port must be loaded with 50 ohms.

For Lower Side Band operation (LSB):

With IF1 and IF2 connected to the direct port (0°) and coupled port (-90°) respectively as shown in the diagram, the LSB signal will reside on the isolated port. The input port must be loaded with 50 ohms.

An alternate method of Selection of USB or LSB:

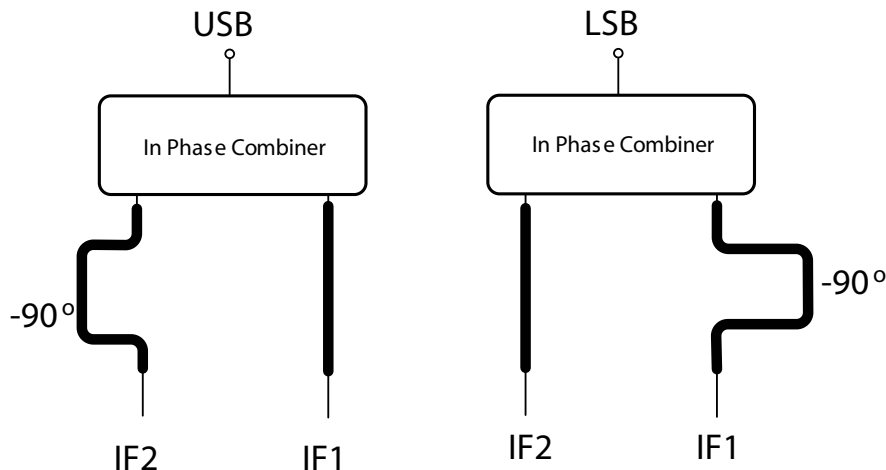

Factory Automation and Identification

Mimix Designator	Package Type	Number of leads offered	W Tape Width	P ₁ Component Pitch	P ₀ Hole Pitch	Reel Diameter	Units per Reel
-QB	QFN (7x7mm)	28	16mm	12mm	4mm	329mm (13in)	1000

Tape and Reel Packaging per the following conditions:

Tape Width: 16 mm
 Tape Pitch (part to part): 12 mm
 Component Orientation: Parts are to be oriented with the PIN 1 closest to the tape's round sprocket holes on the tape's trailing edge.
 Reel Diameter: 329 mm (13 inch)

Note: Tape and Reel packaging is ordered with a -000T suffix. Package is available in 500 unit reels through designated sales channels. Minimum order quantities should be discussed with your local sales representative.

36.0-42.0 GHz GaAs Transmitter SMT, 7x7 mm

April 2009 - Rev 15-Apr-09

Handling and Assembly Information

CAUTION! - Mimix Broadband MMIC Products contain gallium arsenide (GaAs) which can be hazardous to the human body and the environment. For safety, observe the following procedures:

- Do not ingest.
- Do not alter the form of this product into a gas, powder, or liquid through burning, crushing, or chemical processing as these by-products are dangerous to the human body if inhaled, ingested, or swallowed.
- Observe government laws and company regulations when discarding this product. This product must be discarded in accordance with methods specified by applicable hazardous waste procedures.

Life Support Policy - Mimix Broadband's products are not authorized for use as critical components in life support devices or systems without the express written approval of the President and General Counsel of Mimix Broadband. As used herein: (1) Life support devices or systems are devices or systems which, (a) are intended for surgical implant into the body, or (b) support or sustain life, and whose failure to perform when properly used in accordance with instructions for use provided in the labeling, can be reasonably expected to result in a significant injury to the user. (2) A critical component is any component of a life support device or system whose failure to perform can be reasonably expected to cause the failure of the life support device or system, or to affect its safety or effectiveness.

Package Attachment - This packaged product from Mimix Broadband is provided as a rugged surface mount package compatible with high volume solder installation. Vacuum tools or other suitable pick and place equipment may be used to pick and place this part. Care should be taken to ensure that there are no voids or gaps in the solder connection so that good RF, DC and ground connections are maintained. Voids or gaps can eventually lead not only to RF performance degradation, but reduced reliability and life of the product due to thermal stress.

Typical Reflow Profiles

Reflow Profile	SnPb	Pb Free
Ramp Up Rate	3-4 °C/sec	3-4 °C/sec
Activation Time and Temperature	60-120 sec @ 140-160 °C	60-180 sec @ 170-200 °C
Time Above Melting Point	60-150 sec	60-150 sec
Max Peak Temperature	240 °C	265 °C
Time Within 5 °C of Peak	10-20 sec	10-20 sec
Ramp Down Rate	4-6 °C/sec	4-6 °C/sec

Mimix Lead-Free RoHS Compliant Program - Mimix has an active program in place to meet customer and governmental requirements for eliminating lead (Pb) and other environmentally hazardous materials from our products. All Mimix RoHS compliant components are form, fit and functional replacements for their non-RoHS equivalents. Lead plating of our RoHS compliant parts is 100% matte tin (Sn) over copper alloy and is backwards compatible with current standard SnPb low-temperature reflow processes as well as higher temperature (260°C reflow) "Pb Free" processes.

Ordering Information

Part Number for Ordering Description

XU1006-QB-0N00	Ni/Au plated RoHS compliant 7x7 28L surface mount package in bulk quantity
XU1006-QB-0N0T	Ni/Au plated RoHS compliant 7x7 28L surface mount package in tape and reel
XU1006-QB-EV1	XU1006-QB evaluation board



Caution: ESD Sensitive
Appropriate precautions in handling, packaging
and testing devices must be observed.

Proper ESD procedures should be followed when handling this device.

Mimix Broadband, Inc., 10795 Rockley Rd., Houston, Texas 77099
Tel: 281.988.4600 Fax: 281.988.4615 mimixbroadband.com

Page 9 of 9