

DESCRIPTION

The LX5506 is a power amplifier designed for the FCC Unlicensed National Information Infrastructure (U-NII) band, HyperLAN2 and Japan WLAN applications in the 4.9-5.95 GHz frequency range. The PA is implemented as a three-stage monolithic microwave integrated circuit (MMIC) with active bias and complete on-chip input matching. The device is manufactured with an InGaP/GaAs Heterojunction Bipolar Transistor (HBT) IC process (MOCVD). It operates at a single positive voltage supply of 3.3V (nominal), with +26dBm of P1dB and up to 23dB power gain in the 5.15 - 5.85GHz frequency range with a simple output matching capacitor pair.

For OFDM operation (64QAM, 54Mbps), the PA provides +18dBm linear output power with a very low EVM (Error-Vector Magnitude) of 3%, and consumes about 190mA total DC current. At higher supply voltage of 5V, the same device provides +24dBm linear OFDM output power with 5% EVM.

The LX5506 is available in a 16-pin 3mmx3mm micro-lead package (MLP). The compact footprint, low profile, and excellent thermal capability of the MLP package makes the LX5506 an ideal solution for broadband, high-gain power amplifier requirements for IEEE 802.11a, and HiperLAN2 portable WLAN applications.

IMPORTANT: For the most current data, consult MICROSEMI's website: <http://www.microsemi.com>

KEY FEATURES

- Advanced InGaP HBT
- Single-Polarity 3.3V Supply
- EVM ~ 3% at Pout=18dBm for 64QAM/ 54Mbps OFDM
- P1dB ~ +26dBm
- Power Gain ~ 23dB at 5.25GHz for Icq ~100mA
- Power Gain ~ 21dB at 5.85GHz for Icq ~100mA
- Total Current ~190mA at Pout=18dBm at 5.25GHz
- ACPR ~ -50dBc at 30MHz Offset at Pout=18dBm
- Complete On-Chip Input Match
- Simple Output Capacitor Match
- Small Footprint: 3x3mm²
- Low Profile: 0.9mm

APPLICATIONS

- FCC U-NII Wireless
- IEEE 802.11a
- HiperLAN2
- 5GHz Cordless Phone

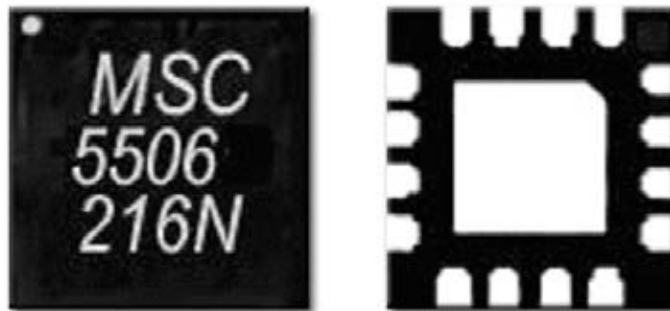
PRODUCT HIGHLIGHT

PACKAGE ORDER INFO

LQ Plastic MLPQ
16-Pin

LX5506-LQ

Note: Available in Tape & Reel.
Append the letter "T" to the part number.
(i.e. LX5506-LQT)

ABSOLUTE MAXIMUM RATINGS

DC Supply Voltage, RF off	6V
Collector Current	600mA
Total Power Dissipation.....	3W
RF Input Power	+15dBm
Maximum Junction Temperature (T _J max)	150°C
Operation Ambient Temperature	-40 to +85°C
Storage Temperature.....	-60 to +150°C

Note: Exceeding these ratings could cause damage to the device. All voltages are with respect to Ground. Currents are positive into, negative out of specified terminal.

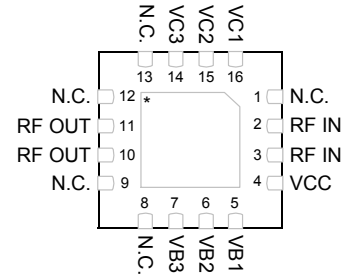
PACKAGE PIN OUT

* Pad is Ground

LQ PACKAGE
(Bottom View)

FUNCTIONAL PIN DESCRIPTION

Name	Description
RF IN	RF input for the power amplifier. This pin is DC-short to GND but AC-coupled to the transistor base of the first stage.
VCC	Supply voltage for the bias reference and control circuits.
VB1	Bias current control voltage for the first stage.
VB2	Bias current control voltage for the second stage.
VB3	Bias current control voltage for the third stage.
RF OUT	RF output for the power amplifier. This pin is AC-coupled and does not require a DC-blocking capacitor.
VC1	Power supply for the first stage amplifier.
VC2	Power supply for the second stage amplifier.
VC3	Power supply for the third stage amplifier.
GND	The center metal base of the MLP package provides both DC and RF ground as well as heat sink for the power amplifier.
N.C.	These are unused pins and not connected to the device. They can be treated either as open pins or connected to ground for better heat dissipation.

ELECTRICAL CHARACTERISTICS

 Test conditions: $V_{cc} = 3.3V$, $V_{ref} = 2.9V$, $I_{cq} = 100mA$, $T_A = 25^{\circ}C$, unless otherwise specified.

Parameter	Condition	Symbol	Min.	Typ.	Max.	Min.	Typ.	Max.	Unit
Frequency Range		f	5.15		5.35	5.7		5.85	GHz
Output Power at 1dB Compression		P _{out}	25	26		25	26		dBm
Power Gain at P _{out} =18dBm		G _p	21	23		19	21		dB
EVM at P _{out} =18dBm	64QAM/54Mbps			3			3		%
Total Current at P _{out} =18dBm		I _{ctotal}		190			200		mA
Quiescent Current		I _{cq}		100			100		mA
Bias Control Reference Current	For I _{cq} =100mA	I _{ref}		2.2			2.2		mA
Small-Signal Gain		S ₂₁		22			20		dB
Gain Flatness	Over 200MHz	ΔS_{21}		+/-0.5			+/-0.5		dB
Gain Variation Over Temperature	-40 to +85°C	ΔS_{21}		3 ^{a)} , 1 ^{b)}			2 ^{a)} , 1 ^{b)}		dB
Input Return Loss		S ₁₁		-15	-10		-15	-10	dB
Output Return Loss		S ₂₂		-7			-15		dB
Reverse Isolation		S ₁₂		-40			-40		dB
Second Harmonic	P _{out} = 18dBm			-40			-60		dBc
Third Harmonic	P _{out} = 18dBm			-40			-40		dBc
Ramp-On Time	10 - 90%	t _{ON}		100			100		ns

 Note a) $V_{ref} = 2.9V$ b) $V_{ref} = 3.0V$

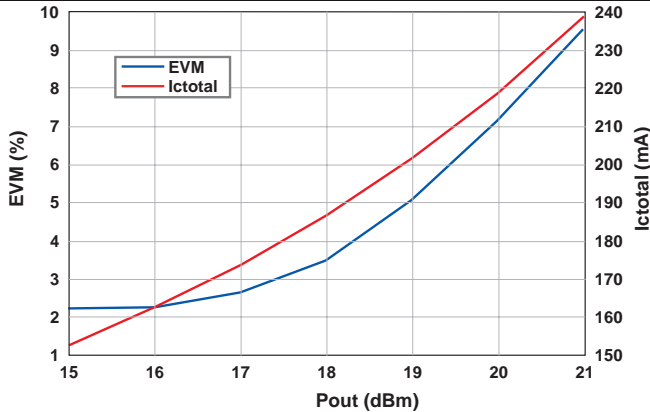
EVM VS POUT FREQ=5.15GHZ

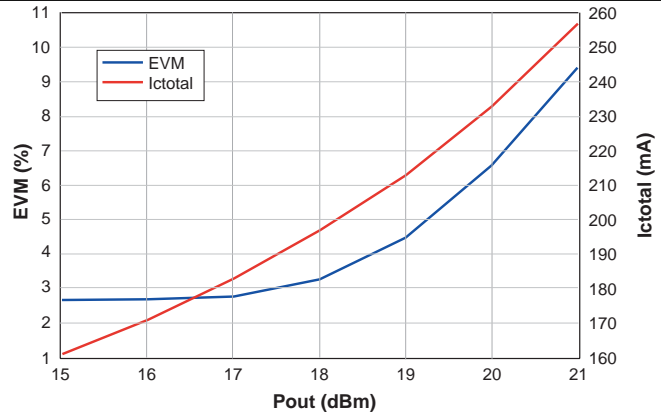
 Typical EVM and Total Current vs. Pout at Vc = 3.3V
(Vc = 3.3V, Icq = 100mA, 64QAM / 54Mbps)

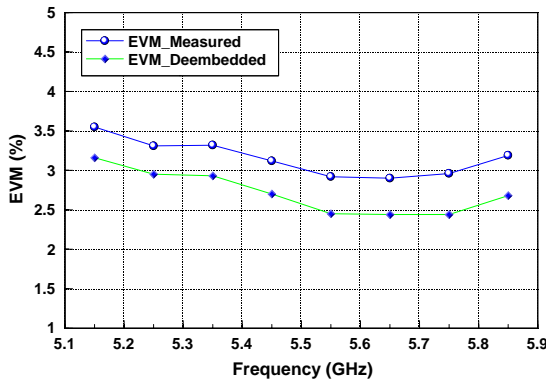
EVM VS POUT FREQ=5.85GHZ

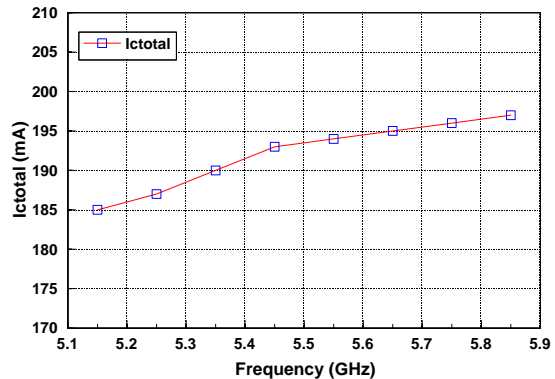
 Typical EVM and Total Current vs. Pout at Vc = 3.3V
(Vc = 3.3V, Icq = 100mA, 64QAM / 54Mbps)

EVM VS FREQUENCY

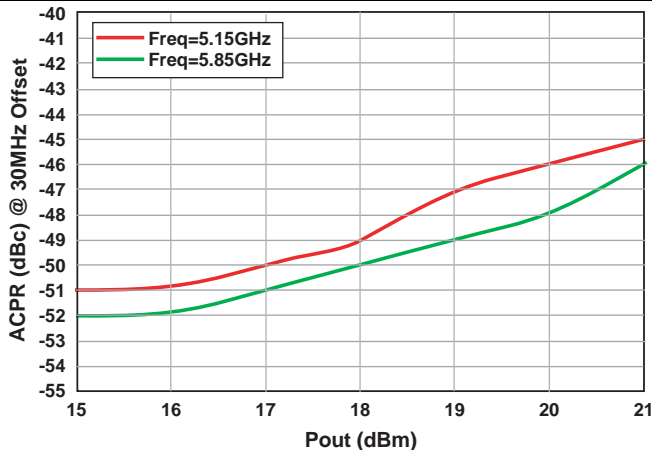
 Typical EVM vs. Frequency
(Vc=3.3V, Icq=100mA, Pout=18dBm, 64QAM/54Mbps)

CURRENT VS FREQUENCY

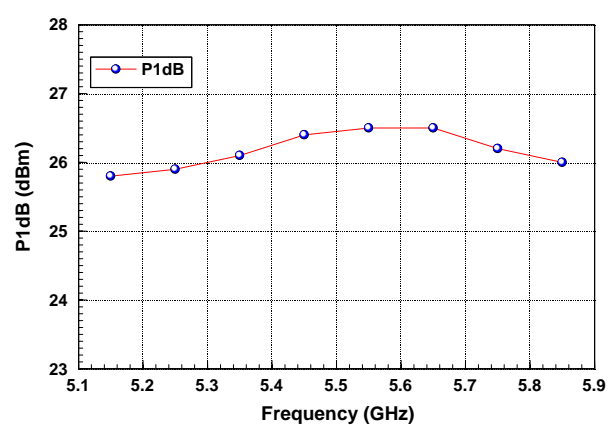
 Typical Total Current vs. Frequency
(Vc=3.3V, Icq=100mA, Pout=18dBm, 64QAM/54Mbps)

Notes: All EVM data are for OFDM signal of 64QAM/54Mbps and are actual measured data without any de-embedding. Source EVM is around 1.4 - 1.8% for the input power levels for test.

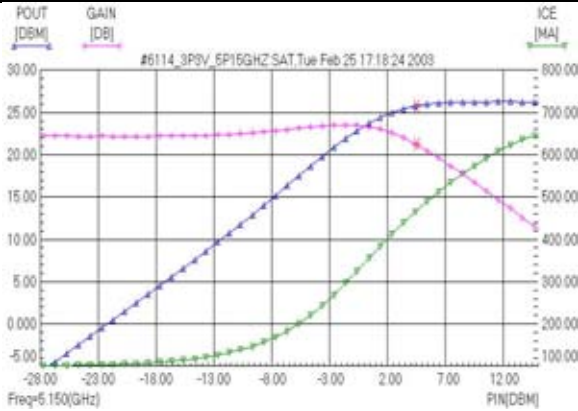
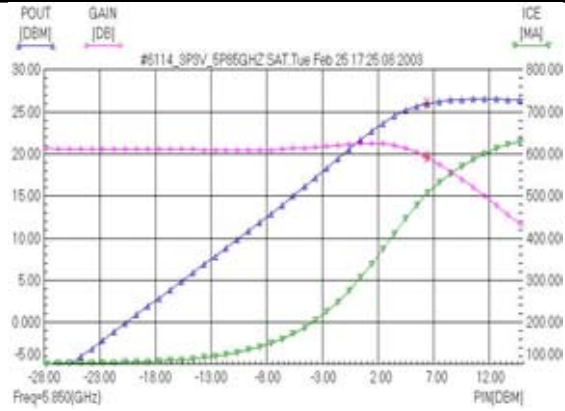
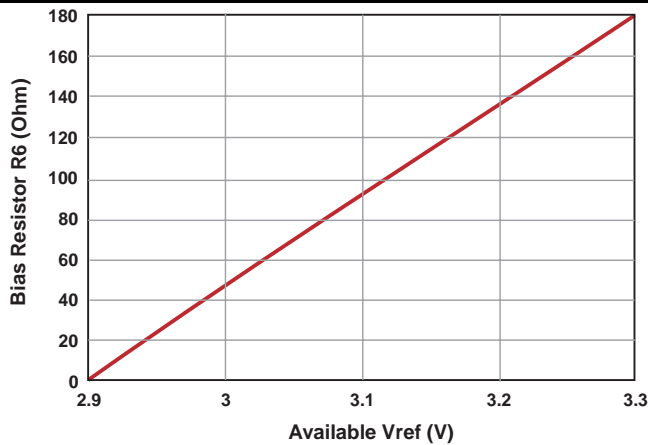
ACPR VS OUTPUT POWER

 Typical ACPR vs. Output Power
(Vc = 3.3V, Icq = 100mA, 64QAM / 54Mbps)

P1dB VS FREQUENCY

 Typical P1dB vs. Frequency
(Icq = 100mA for Vc = 3.3V, Icq = 110mA for Vc=4.5V)

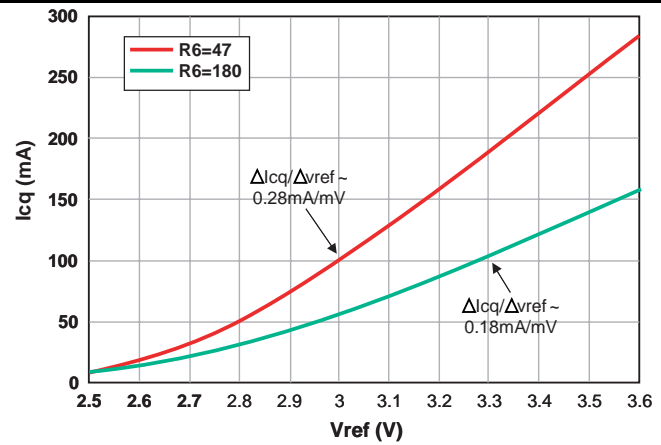
POWER SWEEP DATA 5.15GHZ

POWER SWEEP DATA 5.85GHZ

RECOMMENDED BIAS RESISTOR

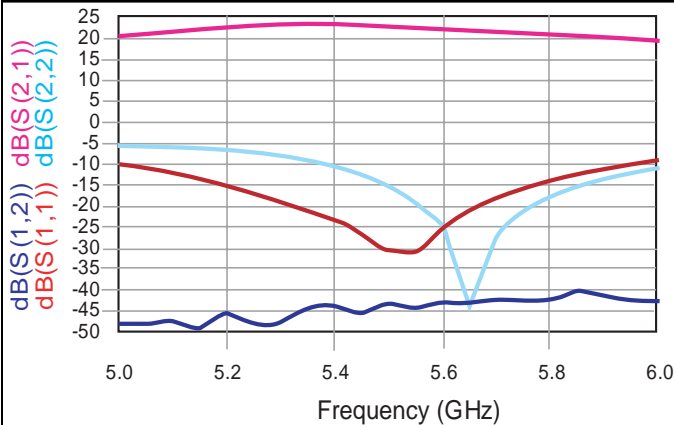
Recommended Bias Resistor for Available Vref
 $(\text{Adjusted } R_6 \text{ value for Obtaining Nominal } I_{cq} = 10mA \text{ at } V_c = 3.3V)$

QUIESCENT CURRENT VS VREF

Quiescent Current vs. Vref
 $(V_c = 3.3V, \text{Bias Resistor } R_6 = 47\Omega \text{ \& } 180\Omega)$

S-PARAMETER DATA

Typical S-Parameter Data at Room Temperature
 $(V_c = 3.3V, R_6 = 0\Omega, V_{ref} = 2.9V, I_{cq} = 100mA)$

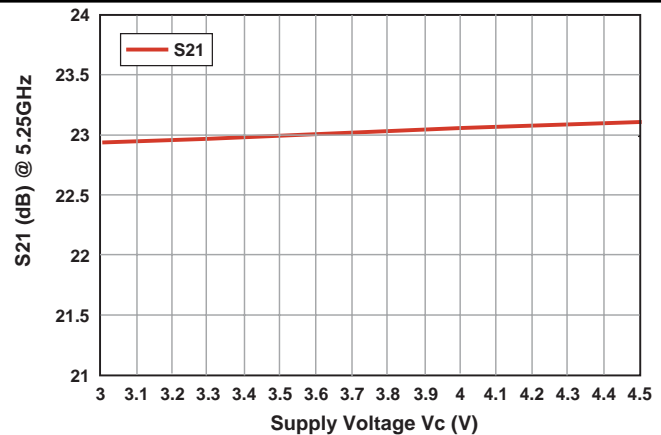
SMALL SIGNAL VS SUPPLY VOLTAGE

Typical Small Signal Gain vs. Supply Voltage
 $(R_6 = 0\Omega, V_{ref} = 2.9V, I_{cq} = 100mA \text{ for } V_c = 3.3V, \text{Freq} = 5.25GHz)$

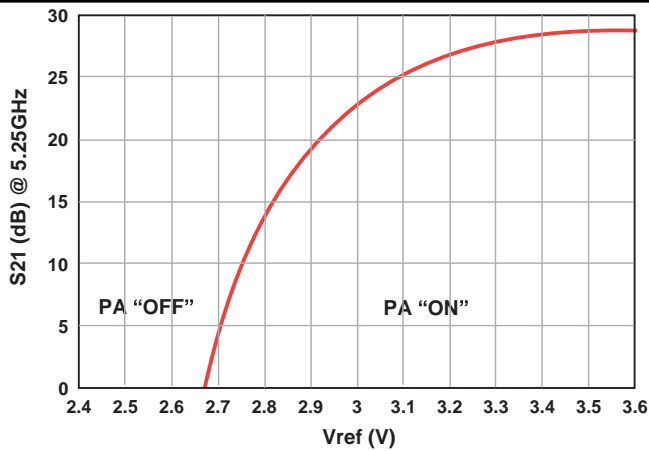
SMALL SIGNAL VS BIAS REF.

Typical Small Signal Gain vs. Bias Reference Voltage
 (Vc = 3.3V, R6 = 47Ω, Vref = 3.0V, Icq = 100mA, Freq = 5.25GHz)

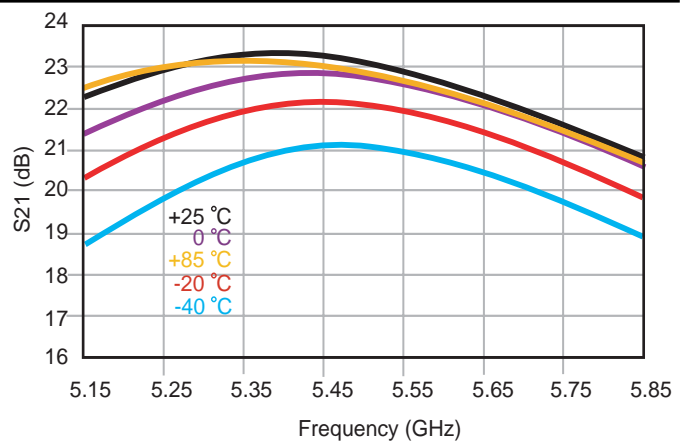
SMALL SIGNAL GAIN OVER TEMP

Typical Small Signal Gain Variation Over Temperature
 (Vc = 3.3V, R6 = 0Ω, Vref = 2.9V, Icq = 100mA at Room Temperature)

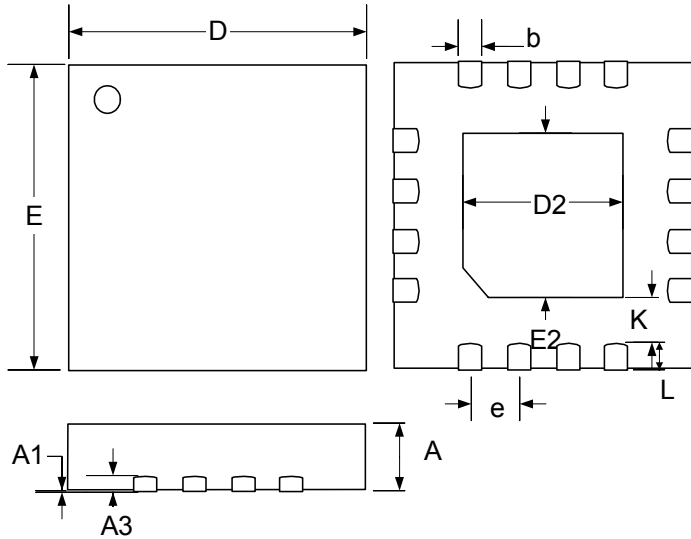
PACKAGE DIMENSIONS
LQ 16-Pin MLPQ 3x3 (75 x 75 mil DAP)

Dim	MILLIMETERS		INCHES	
	MIN	MAX	MIN	MAX
A	0.80	0.80	0.031	0.031
A1	0	0.05	0	0.002
A3	0.20 REF		0.008 REF	
b	0.18	0.30	0.007	0.012
D	3.00 BSC		0.118 BSC	
E	3.00 BSC		0.118 BSC	
e	0.50 BSC		0.020 BSC	
D2	1.55	1.80	0.061	0.071
E2	1.55	1.80	0.061	0.071
K	0.2	-	0.008	-
L	0.35	0.50	0.012	0.020

Note:

- Dimensions do not include mold flash or protrusions; these shall not exceed 0.155mm(.006") on any side. Lead dimension shall not include solder coverage.



Microsemi[®]

LX5506

InGaP HBT 4.5 – 6GHz Power Amplifier

PRODUCTION DATA SHEET

NOTES

PRODUCTION DATA – Information contained in this document is proprietary to Microsemi and is current as of publication date. This document may not be modified in any way without the express written consent of Microsemi. Product processing does not necessarily include testing of all parameters. Microsemi reserves the right to change the configuration and performance of the product and to discontinue product at any time.