

# 2SK3048

## Silicon N-Channel Power F-MOS FET

### ■ Features

- Avalanche energy capacity guaranteed
- High-speed switching
- Low ON-resistance
- No secondary breakdown

### ■ Applications

- Contactless relay
- Diving circuit for a solenoid
- Driving circuit for a motor
- Control equipment
- Switching power supply

### ■ Absolute Maximum Ratings ( $T_C = 25^\circ\text{C}$ )

Parameter	Symbol	Rated	Unit
Drain to Source breakdown voltage	$V_{DSS}$	600	V
Gate to Source voltage	$V_{GSS}$	$\pm 30$	V
Drain current	DC	$I_D$	$\pm 3$ A
	Pulse	$I_{DP}$	$\pm 6$ A
Avalanche energy capacity	EAS*	22.5	mJ
Allowable power dissipation	$T_C = 25^\circ\text{C}$	$P_D$	35
	$T_a = 25^\circ\text{C}$		2
Channel temperature	$T_{ch}$	150	$^\circ\text{C}$
Storage temperature	$T_{stg}$	-55 to +150	$^\circ\text{C}$

\*  $L = 5\text{mH}$ ,  $I_L = 3\text{A}$ , 1 pulse

### ■ Electrical Characteristics ( $T_C = 25^\circ\text{C}$ )

Parameter	Symbol	Conditions	min	typ	max	Unit	
Drain to Source cut-off current	$I_{DSS}$	$V_{DS} = 480\text{V}$ , $V_{GS} = 0$			100	$\mu\text{A}$	
Gate to Source leakage current	$I_{GSS}$	$V_{GS} = \pm 30\text{V}$ , $V_{DS} = 0$			$\pm 1$	$\mu\text{A}$	
Drain to Source breakdown voltage	$V_{DSS}$	$I_D = 1\text{mA}$ , $V_{GS} = 0$	600			V	
Gate threshold voltage	$V_{th}$	$V_{DS} = 25\text{V}$ , $I_D = 1\text{mA}$	2		5	V	
Drain to Source ON-resistance	$R_{DS(on)}$	$V_{GS} = 10\text{V}$ , $I_D = 2\text{A}$		1.7	2.5	$\Omega$	
Forward transfer admittance	$ Y_{fs} $	$V_{DS} = 25\text{V}$ , $I_D = 2\text{A}$	1.5	2.5		S	
Diode forward voltage	$V_{DSF}$	$I_{DR} = 3\text{A}$ , $V_{GS} = 0$			-1.5	V	
Input capacitance (Common Source)	$C_{iss}$	$V_{DS} = 20\text{V}$ , $V_{GS} = 0$ , $f = 1\text{MHz}$		750		pF	
Output capacitance (Common Source)	$C_{oss}$				80		pF
Reverse transfer capacitance (Common Source)	$C_{rss}$				25		pF
Turn-on time (delay time)	$t_{d(on)}$	$V_{DD} = 200\text{V}$ , $I_D = 2\text{A}$ $V_{GS} = 10\text{V}$ , $R_L = 100\Omega$		15		ns	
Rise time	$t_r$				25		ns
Turn-off time (delay time)	$t_{d(off)}$				90		ns
Fall time	$t_f$				40		ns

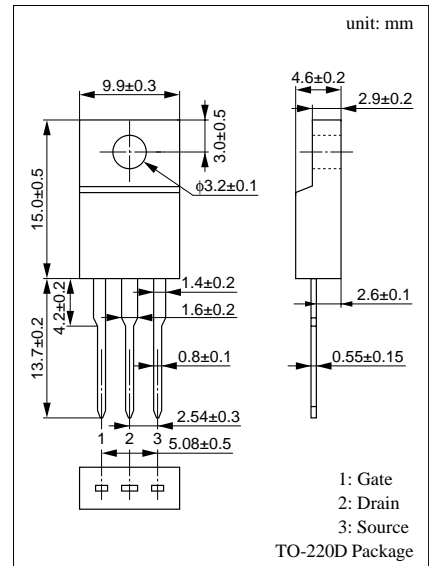

Area of safe operation (ASO)

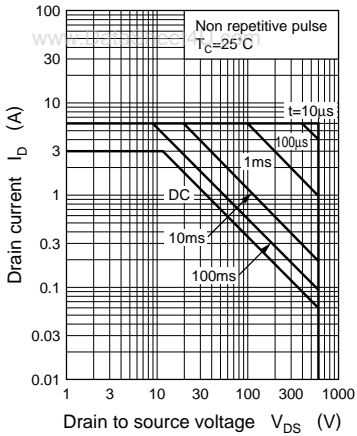

$P_D - T_a$

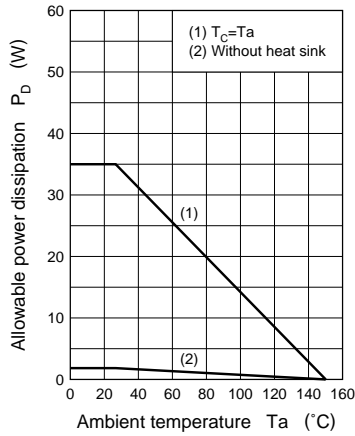

IAS — L-load

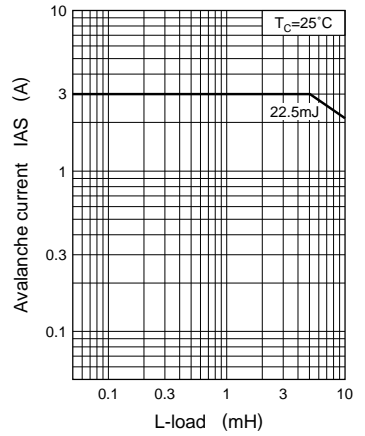

$I_D - V_{DS}$

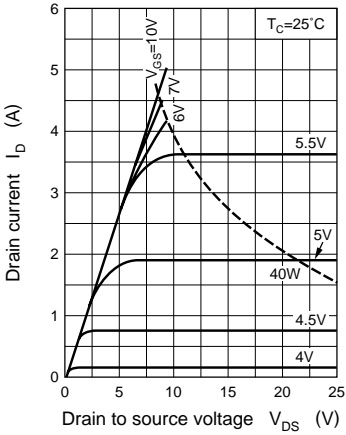

$I_D - V_{GS}$

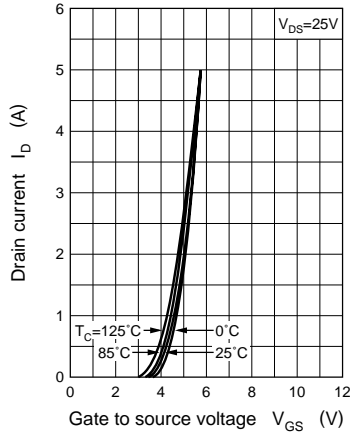

$V_{DS} - V_{GS}$

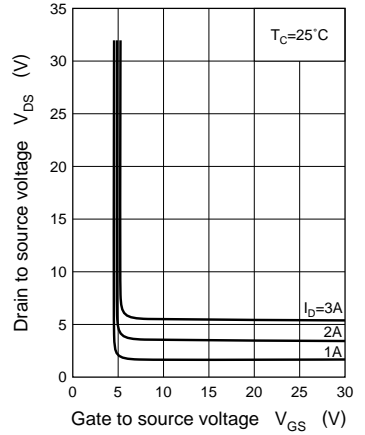

$R_{DS(on)} - I_D$

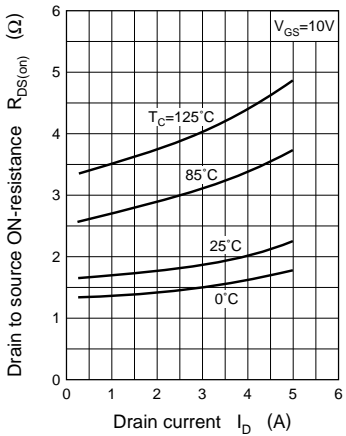

$|Y_{fs}| - I_D$

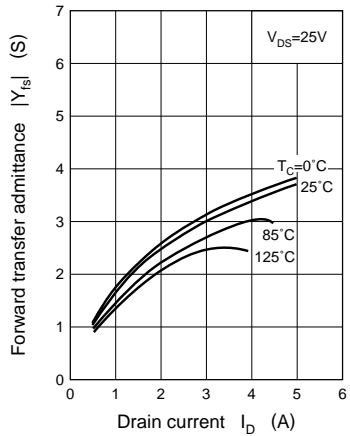

$C_{iss}, C_{oss}, C_{rss} - V_{DS}$

