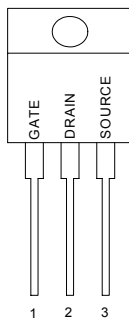

APPLICATION

- ◆ DC motor control
- ◆ UPS
- ◆ Class D Amplifier

V_{DSS}	$R_{DS(ON)}$ Typ.	I_D
60V	15.8m Ω	60A

PIN CONFIGURATION

 TO-220
Front View

FEATURES

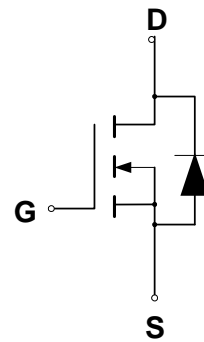
- ◆ Low ON Resistance
- ◆ Low Gate Charge
- ◆ Peak Current vs Pulse Width Curve
- ◆ Inductive Switching Curves

SYMBOL

N-Channel MOSFET

ABSOLUTE MAXIMUM RATINGS

Rating	Symbol	Value	Unit
Drain to Source Voltage (Note 1)	V_{DSS}	60	V
Drain to Current - Continuous $T_c = 25^\circ\text{C}$, $V_{GS}@10\text{V}$	I_D	60	A
	I_D	43	
	I_{DM}	241	
Gate-to-Source Voltage - Continue	V_{GS}	± 20	V
Total Power Dissipation	P_D	150	W
		Derating Factor above 25	1.0
Peak Diode Recovery dv/dt (Note 3)	dv/dt	4.5	V/ns
Operating Junction and Storage Temperature Range	T_J, T_{STG}	-55 to 175	
Single Pulse Avalanche Energy $L=144\mu\text{H}, I_D=40$ Amps	E_{AS}	500	mJ
Maximum Lead Temperature for Soldering Purposes	T_L	300	
Maximum Package Body for 10 seconds	T_{PKG}	260	
Pulsed Avalanche Rating	I_{AS}	60	A

THERMAL RESISTANCE

Symbol	Parameter	Min	Typ	Max	Units	Test Conditions
$R_{\theta JC}$	Junction-to-case			1.0	/W	Water cooled heatsink, P_D adjusted for a peak junction temperature of +175
$R_{\theta JA}$	Junction-to-ambient			62	/W	1 cubic foot chamber, free air

ORDERING INFORMATION

Part Number	Package
CMT60N06	TO-220

ELECTRICAL CHARACTERISTICS

 Unless otherwise specified, $T_J = 25$.

Characteristic		Symbol	CMT60N06			Units
			Min	Typ	Max	
OFF Characteristics						
Drain-to-Source Breakdown Voltage ($V_{GS} = 0\text{ V}$, $I_D = 250\ \mu\text{A}$)		V_{DSS}	60			V
Breakdown Voltage Temperature Coefficient (Reference to 25 , $I_D = 250\ \mu\text{A}$)		$V_{DSS}/\Delta T_J$		0.069		mV/
Drain-to-Source Leakage Current ($V_{DS} = 60\text{ V}$, $V_{GS} = 0\text{ V}$, $T_J = 25$) ($V_{DS} = 48\text{ V}$, $V_{GS} = 0\text{ V}$, $T_J = 150$)		I_{DSS}			25 250	μA
Gate-to-Source Forward Leakage ($V_{GS} = 20\text{ V}$)		I_{GSS}			100	nA
Gate-to-Source Reverse Leakage ($V_{GS} = -20\text{ V}$)		I_{GSS}			-100	nA
ON Characteristics						
Gate Threshold Voltage ($V_{DS} = V_{GS}$, $I_D = 250\ \mu\text{A}$)		$V_{GS(th)}$	1.0	2.0	3.0	V
Static Drain-to-Source On-Resistance (Note 4) ($V_{GS} = 10\text{ V}$, $I_D = 60\text{A}$)		$R_{DS(on)}$		15.8	18	m Ω
Forward Transconductance ($V_{DS} = 15\text{ V}$, $I_D = 60\text{A}$) (Note 4)		g_{FS}		36		S
Dynamic Characteristics						
Input Capacitance	$(V_{DS} = 25\text{ V}$, $V_{GS} = 0\text{ V}$, $f = 1.0\text{ MHz}$)	C_{iss}		1430		pF
Output Capacitance		C_{oss}		420		pF
Reverse Transfer Capacitance		C_{rss}		88		pF
Total Gate Charge ($V_{GS} = 10\text{ V}$)	$(V_{DS} = 30\text{ V}$, $I_D = 60\text{ A}$, $V_{GS} = 10\text{ V}$) (Note 5)	Q_g		37.7		nC
Gate-to-Source Charge		Q_{gs}		8.4		nC
Gate-to-Drain ("Miller") Charge		Q_{gd}		9.8		nC
Resistive Switching Characteristics						
Turn-On Delay Time	$(V_{DD} = 30\text{ V}$, $I_D = 60\text{ A}$, $V_{GS} = 10\text{ V}$, $R_G = 9.1\Omega$) (Note 5)	$t_{d(on)}$		12.1		ns
Rise Time		t_{rise}		64		ns
Turn-Off Delay Time		$t_{d(off)}$		69		ns
Fall Time		t_{fall}		39		ns
Source-Drain Diode Characteristics						
Continuous Source Current (Body Diode)	Integral pn-diode in MOSFET	I_S			60	A
Pulse Source Current (Body Diode)		I_{SM}			241	A
Diode Forward On-Voltage ($I_S = 60\text{ A}$, $V_{GS} = 0\text{ V}$)		V_{SD}			1.5	V
Reverse Recovery Time	$(I_F = 60\text{ A}$, $V_{GS} = 0\text{ V}$, $d_i/d_t = 100\text{A}/\mu\text{s}$)	t_{rr}		55		ns
Reverse Recovery Charge		Q_{rr}		110		nC



CMT60N06

N-CHANNEL Logic Level Power MOSFET

Note 1: $T_J = +25$ to $+175$

Note 2: Repetitive rating; pulse width limited by maximum junction temperature.

Note 3: $I_{SD} = 60A$, $di/dt \leq 100A/\mu s$, $V_{DD} \leq BV_{DSS}$, $T_J = +175$

Note 4: Pulse width $\leq 250\mu s$; duty cycle $\leq 2\%$

Note 5: Essentially independent of operating temperature.

Figure 1. Maximum Effective Thermal Impedance, Junction-to-Case

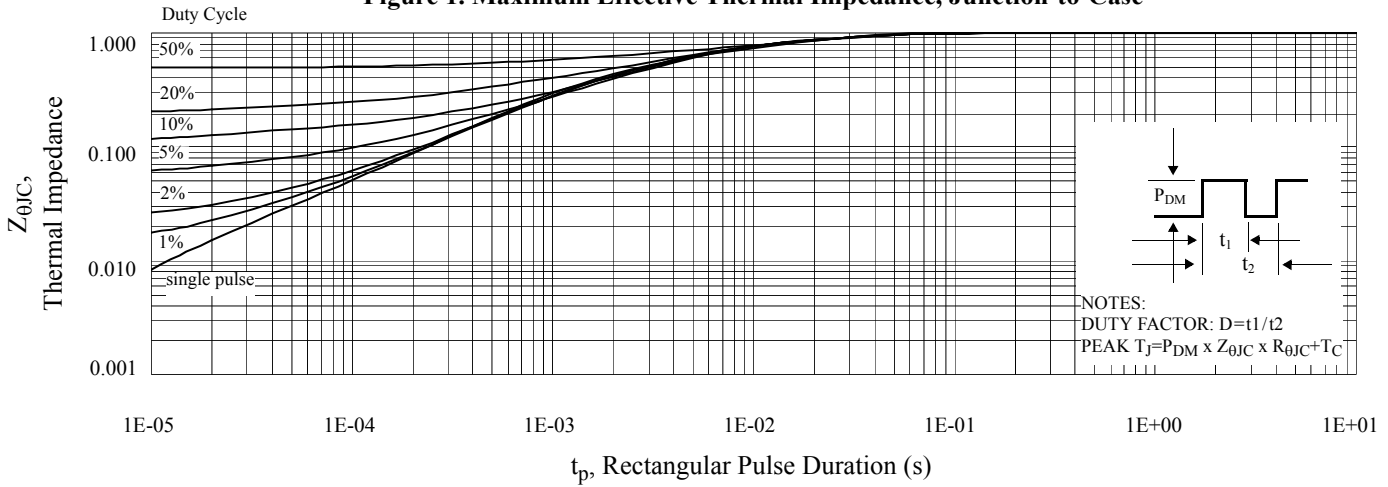

Figure 2. Maximum Power Dissipation vs Case Temperature

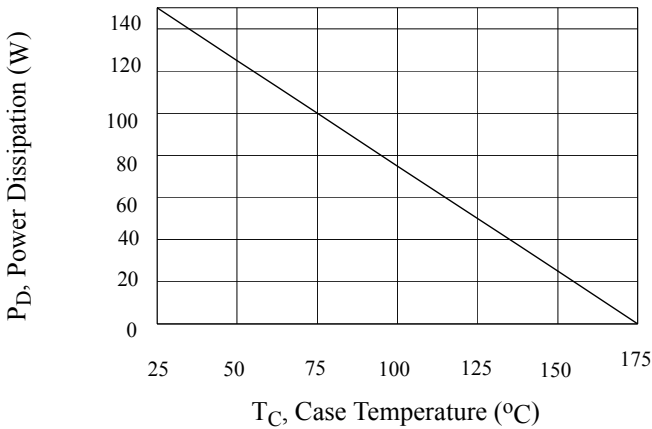

Figure 3. Maximum Continuous Drain Current vs Case Temperature

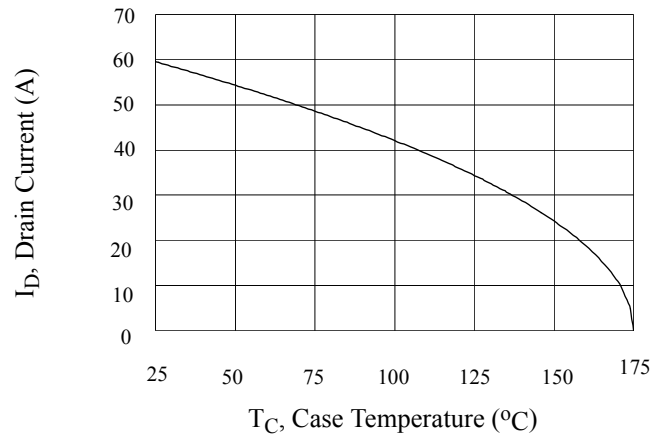

Figure 4. Typical Output Characteristics

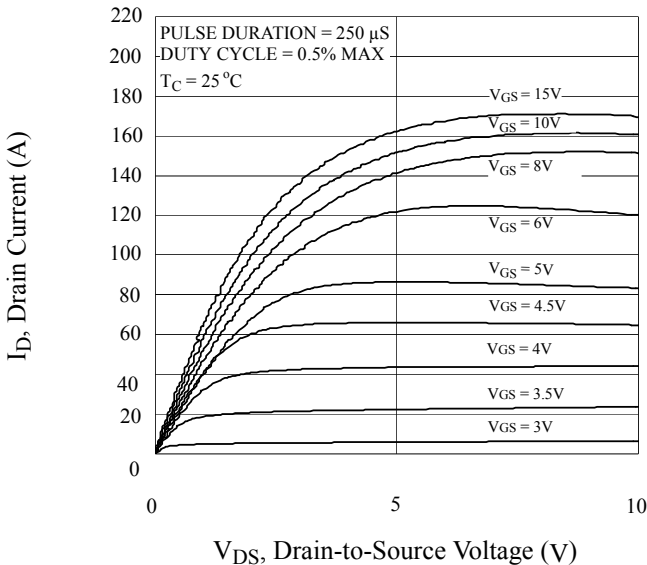

Figure 5. Typical Drain-to-Source ON Resistance vs Gate Voltage and Drain Current

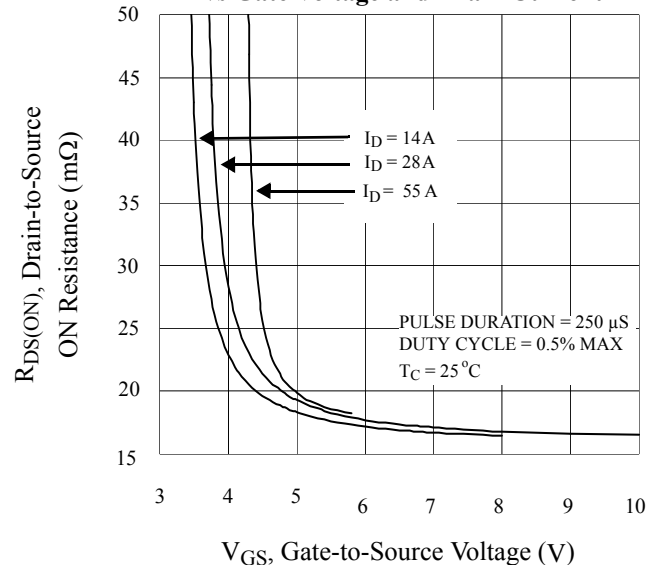

Figure 6. Maximum Peak Current Capability

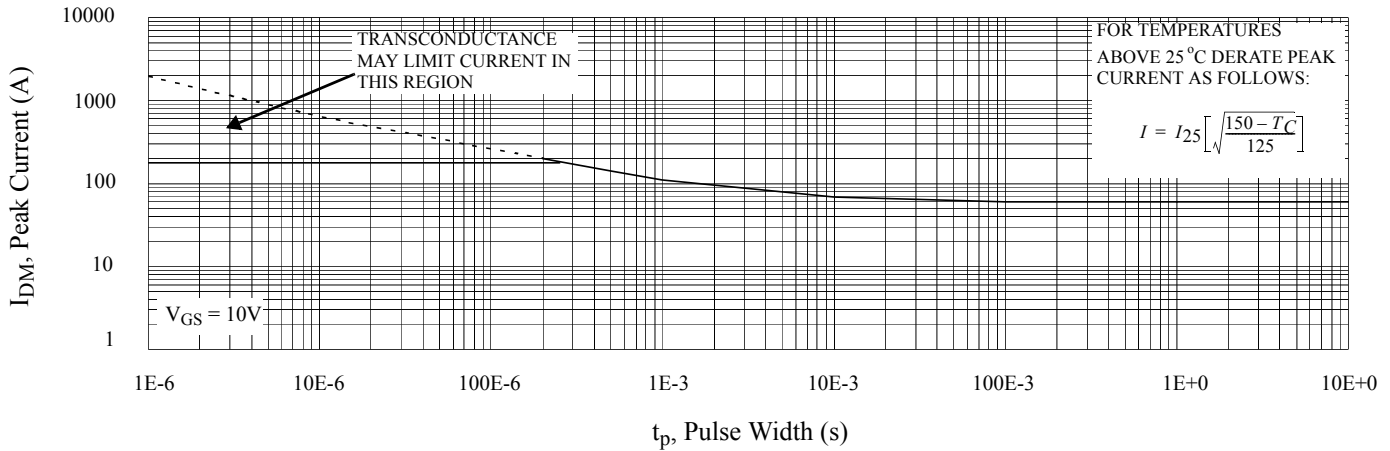

Figure 7. Typical Transfer Characteristics

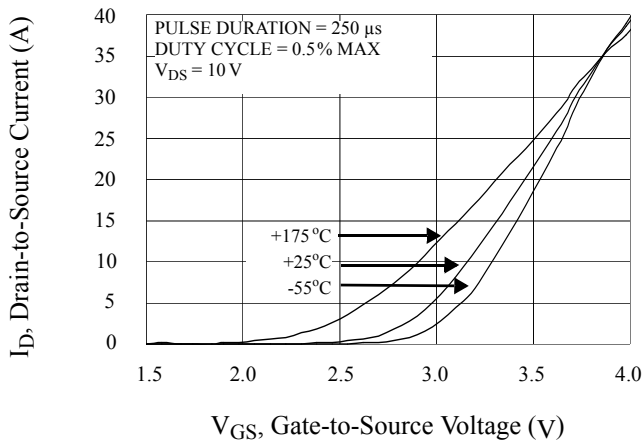

Figure 8. Unclamped Inductive Switching Capability

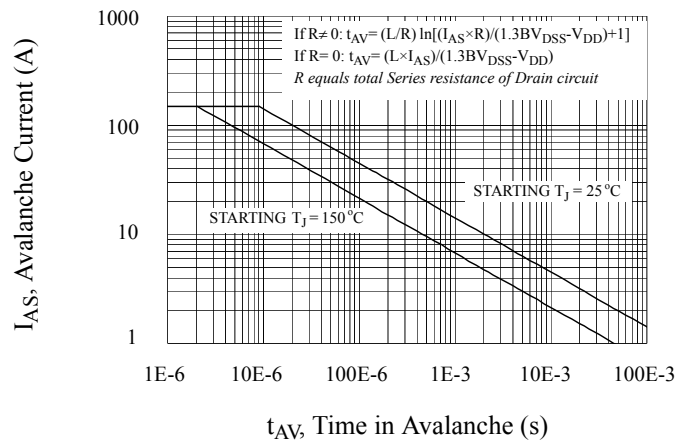

Figure 9. Typical Drain-to-Source ON Resistance vs Drain Current

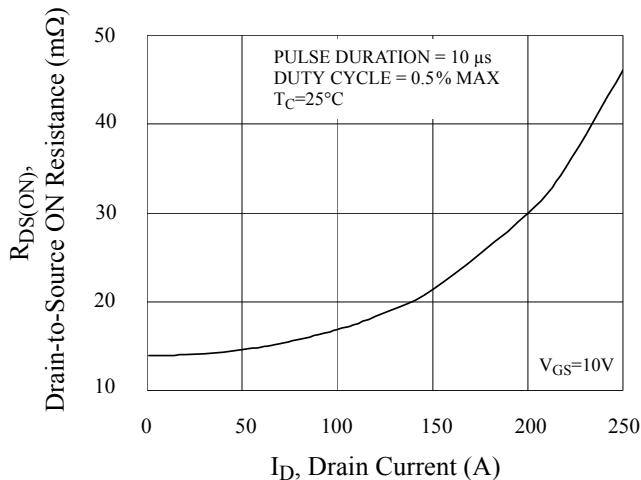

Figure 10. Typical Drain-to-Source ON Resistance vs Junction Temperature

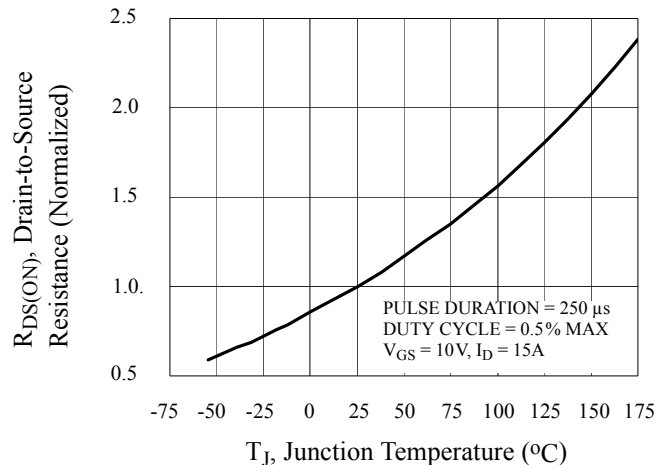

Figure 11. Typical Breakdown Voltage vs Junction Temperature

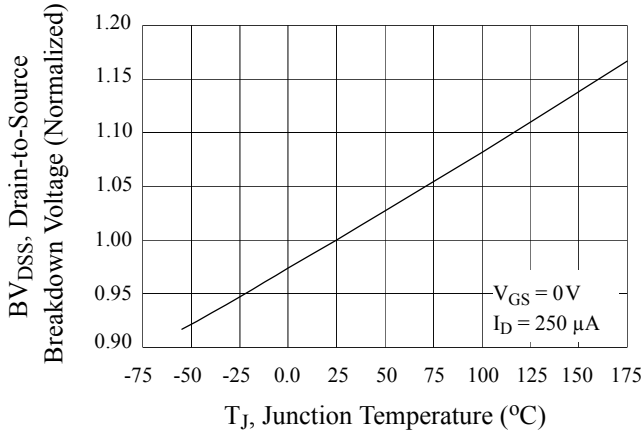

Figure 12. Typical Threshold Voltage vs Junction Temperature

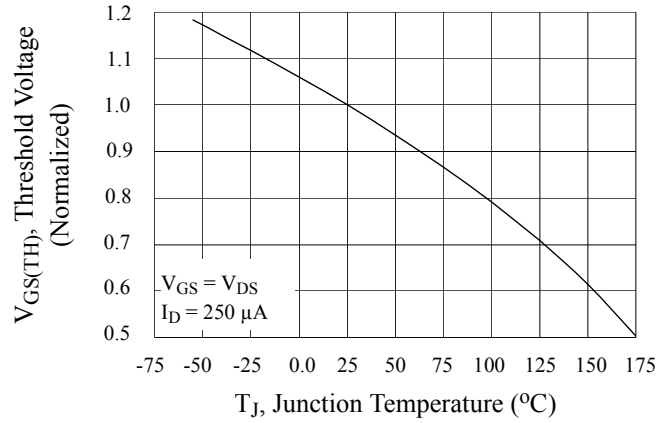

Figure 13. Maximum Forward Bias Safe Operating Area

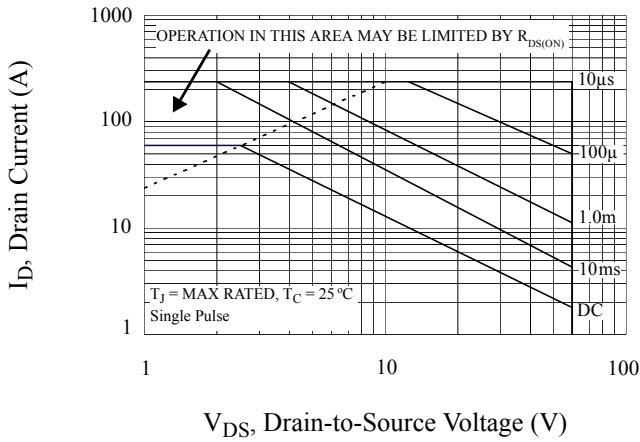

Figure 14. Typical Capacitance vs Drain-to-Source Voltage

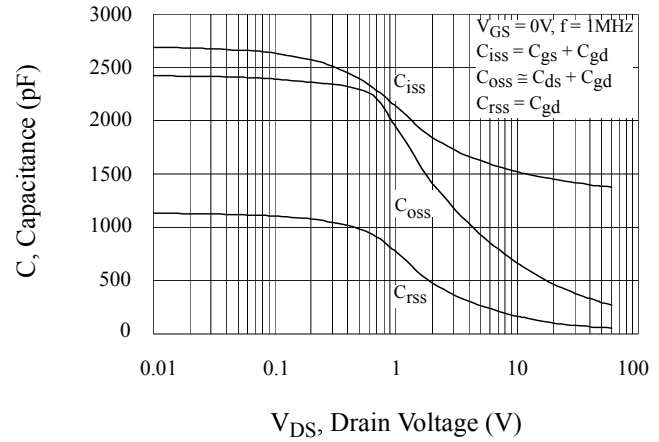

Figure 15. Typical Gate Charge vs Gate-to-Source Voltage

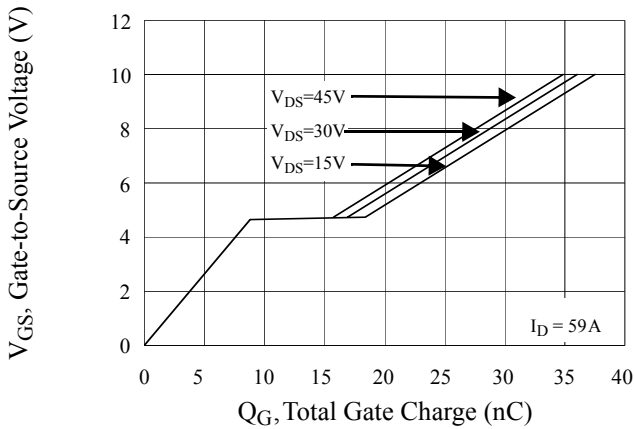
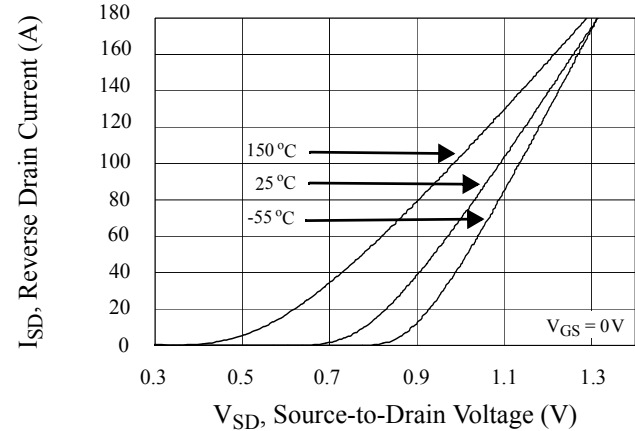
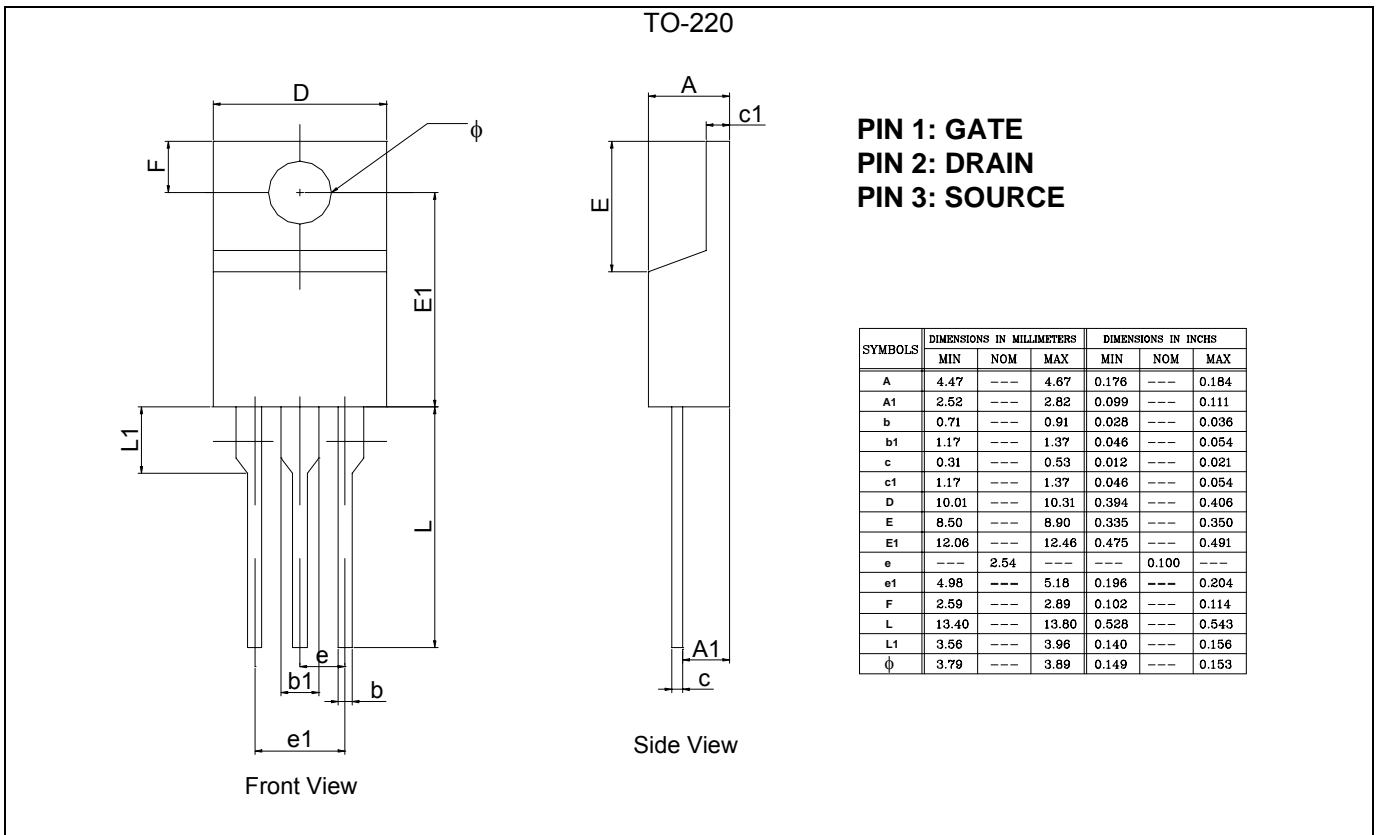

Figure 16. Typical Body Diode Transfer Characteristics



PACKAGE DIMENSION



IMPORTANT NOTICE

Champion Microelectronic Corporation (CMC) reserves the right to make changes to its products or to discontinue any integrated circuit product or service without notice, and advises its customers to obtain the latest version of relevant information to verify, before placing orders, that the information being relied on is current.

A few applications using integrated circuit products may involve potential risks of death, personal injury, or severe property or environmental damage. CMC integrated circuit products are not designed, intended, authorized, or warranted to be suitable for use in life-support applications, devices or systems or other critical applications. Use of CMC products in such applications is understood to be fully at the risk of the customer. In order to minimize risks associated with the customer's applications, the customer should provide adequate design and operating safeguards.

HsinChu Headquarter

5F-1, No. 11, Park Avenue II,
Science-Based Industrial Park,
HsinChu City, Taiwan
TEL: +886-3-567 9979
FAX: +886-3-567 9909

Sales & Marketing

11F, No. 306-3, SEC. 1, Ta Tung Road,
Hsichih, Taipei Hsien 221, Taiwan
TEL: +886-2-8692 1591
FAX: +886-2-8692 1596
