

MODEL BMB SERIES

Surface Mount

Multilayer Chip Beads

0402 -1812 Industry Sizes

NEW CURVES/NEW SIZES

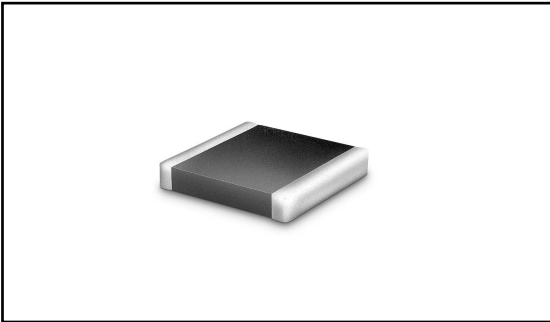

FEATURES AND BENEFITS

- Standard and high speed signals
- Monolithic construction for high reliability
- Choice of various sizes and materials for a wide range of applications
- Designed to offer high impedance for volume
- Compatible with vapor phase and infrared reflow soldering
- Wide frequency range — 10 MHz to 500 MHz

APPLICATIONS

- Instrumentation
- Mobile communication equipment
- Notebook computers
- Video and audio equipment
- Video games
- Medical equipment

ENVIRONMENTAL

Operating Temperature Range	Standard: -25°C to +85°C Optional Extended Range: -40°C to +125°C
Storage Temperature Range	-40°C to +85°C, 70% R.H., Max.
Resistance to Solder Heat	260°C for 10 sec.

Specifications subject to change without notice.

6

0603 IMPEDANCE VS. FREQUENCY - STANDARD SPEED

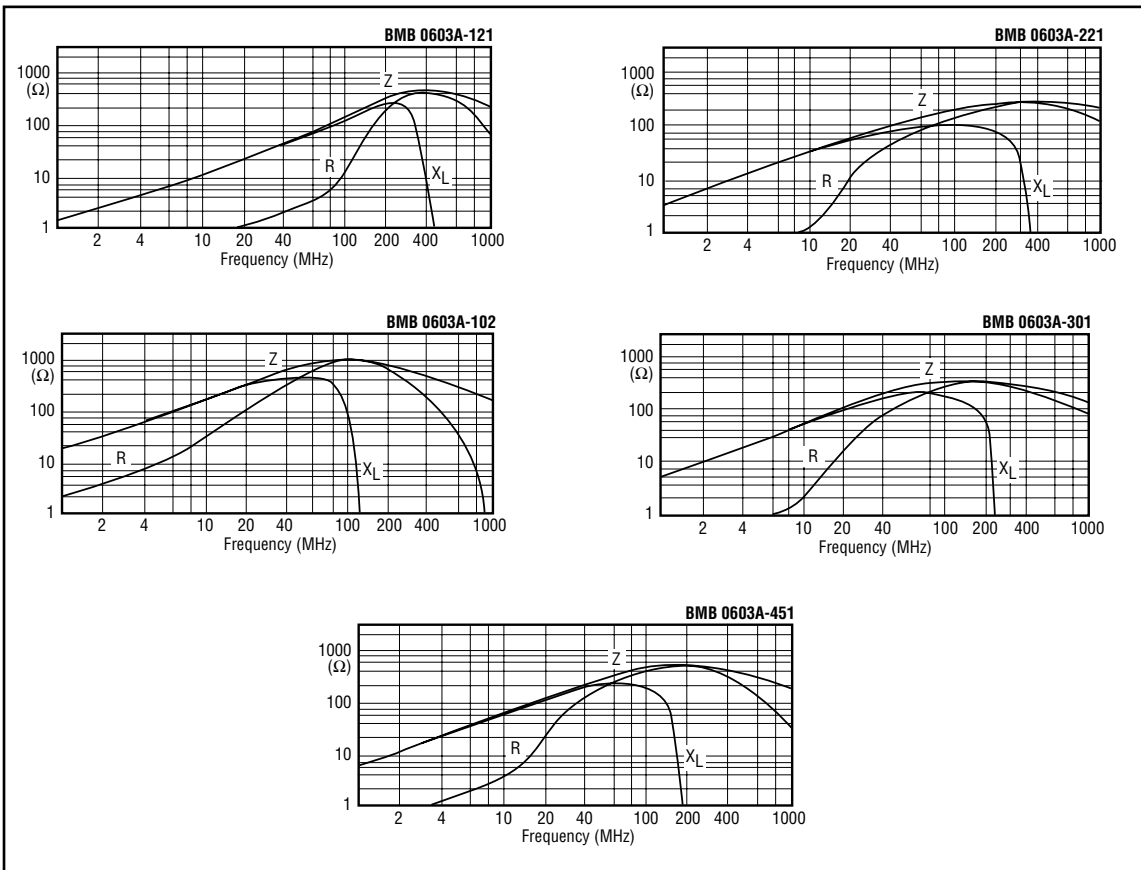

0402 & 0603 ELECTRICAL CHARACTERISTICS - STANDARD SPEED

Part Number	Impedance $Z \Omega \pm 25\%$ @ 100 MHz	DC Resistance Ω Max.	Rated Current mA Max.
BMB 0402A-600	60	0.30	200
BMB 0402A-121	120	0.40	150
BMB 0402A-301	300	0.80	50
BMB 0402A-601	600	1.00	50
BMB 0603A-100	10	0.05	500
BMB 0603A-300	30	0.09	500
BMB 0603A-400	40	0.10	400
BMB 0603A-600	60	0.10	400
BMB 0603A-680	68	0.10	200

0603 IMPEDANCE VS. FREQUENCY - STANDARD SPEED

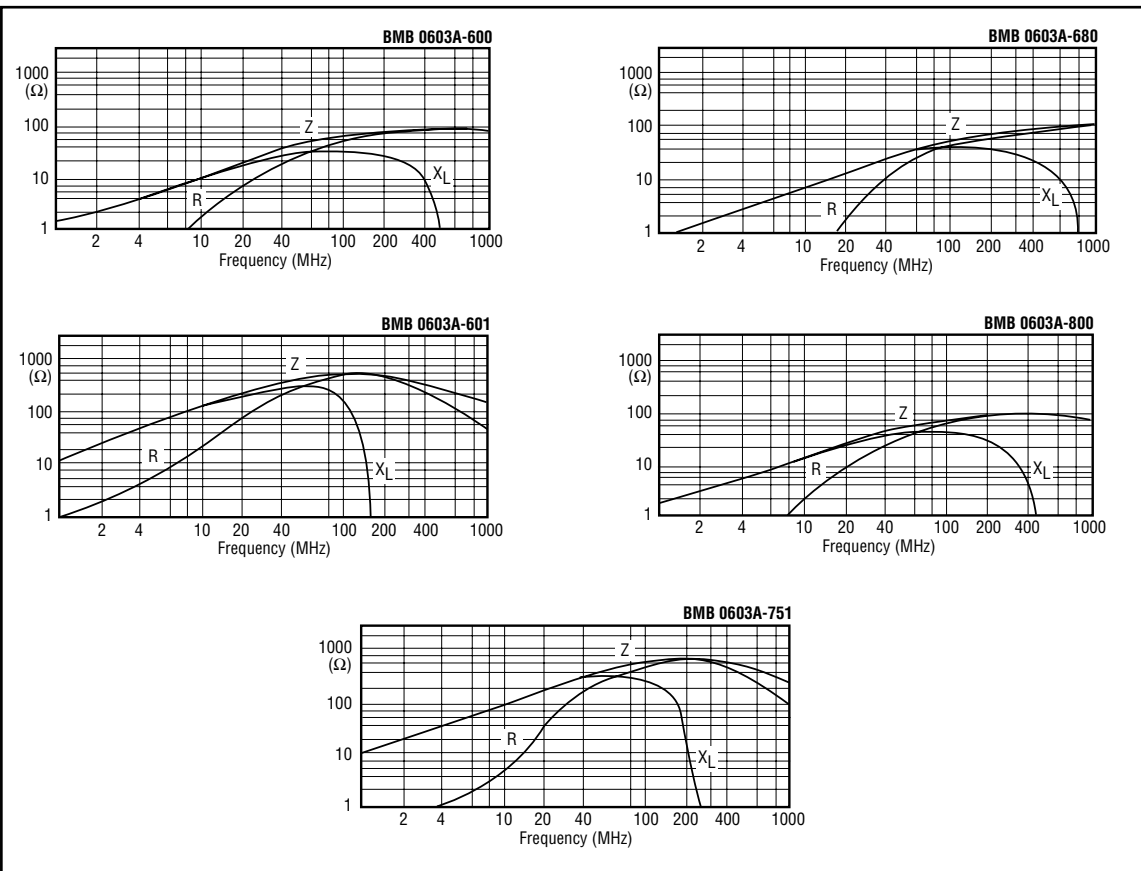

6

0603 ELECTRICAL CHARACTERISTICS - STANDARD SPEED

Part Number	Impedance $Z \Omega \pm 25\%$ @ 100 MHz	DC Resistance Ω Max.	Rated Current mA Max.
BMB 0603A-800	80	0.20	150
BMB 0603A-121	120	0.20	150
BMB 0603A-181	180	0.30	150
BMB 0603A-221	220	0.30	150
BMB 0603A-301	300	0.35	150
BMB 0603A-451	450	0.40	100
BMB 0603A-601	600	0.45	100
BMB 0603A-751	750	0.60	100
BMB 0603A-102	1000	0.60	100

0603 IMPEDANCE VS. FREQUENCY - HIGH SPEED

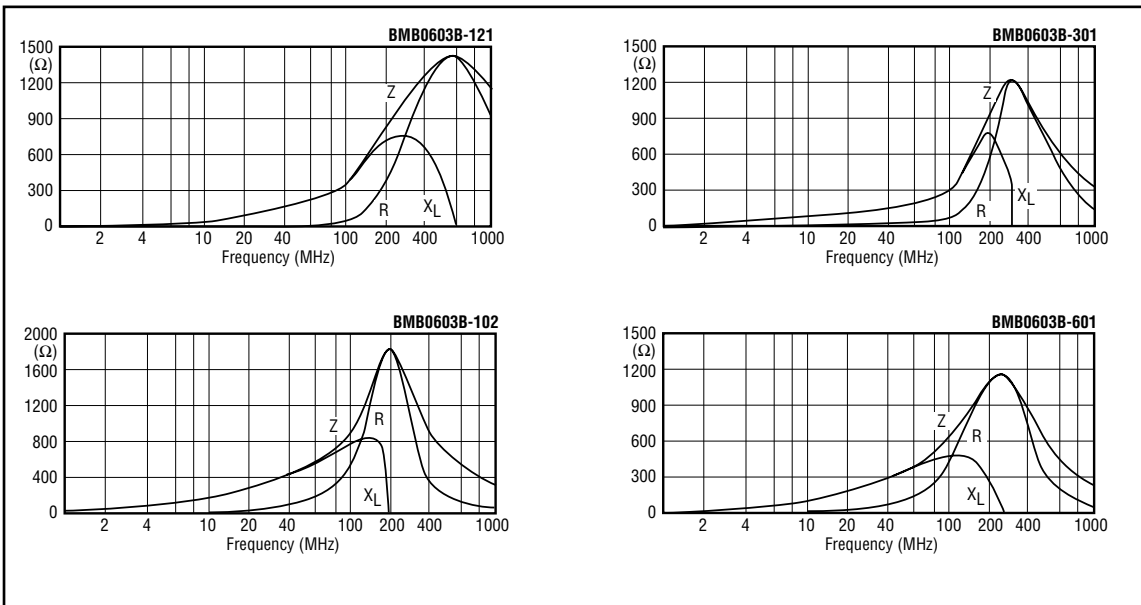

0603 ELECTRICAL CHARACTERISTICS - HIGH SPEED

Part Number	Impedance $Z \Omega \pm 25\%$ @ 100 MHz	DC Resistance Ω Max.	Rated Current mA Max.
BMB 0603B-121	120	0.20	150
BMB 0603B-301	300	0.35	150
BMB 0603B-601	600	0.45	100
BMB 0603B-102	1200	0.60	100

0805 IMPEDANCE VS. FREQUENCY - STANDARD SPEED

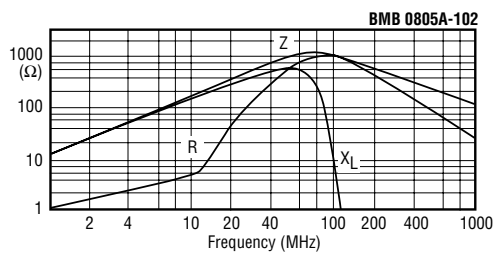
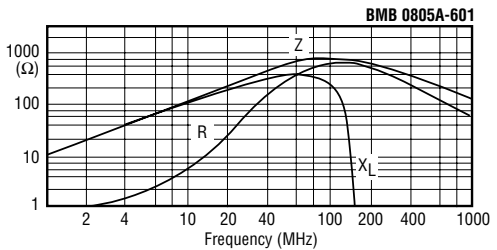
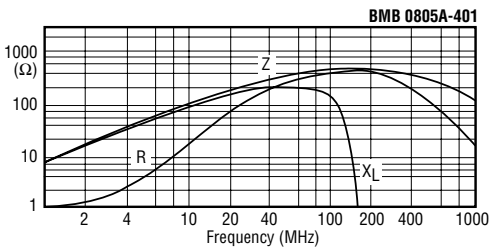
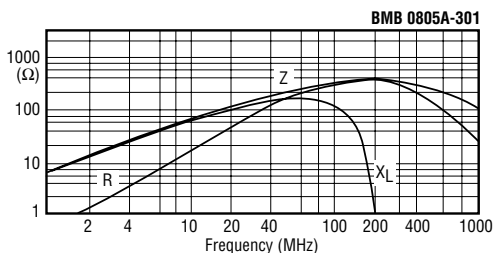
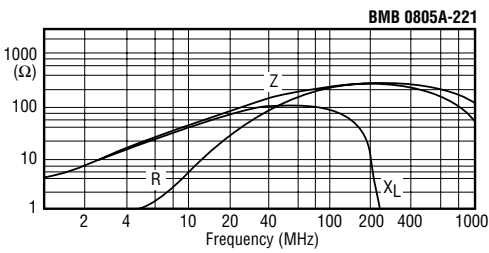
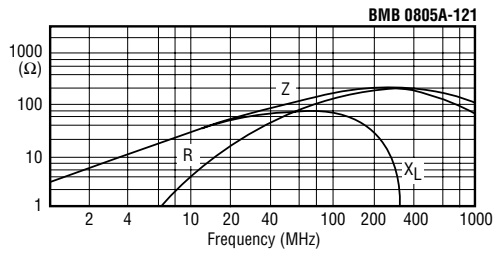
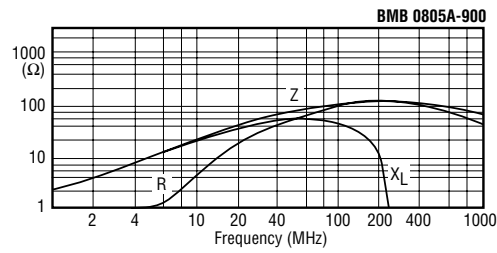
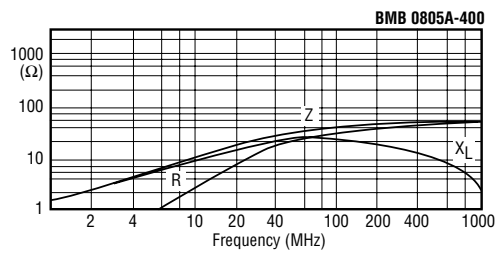
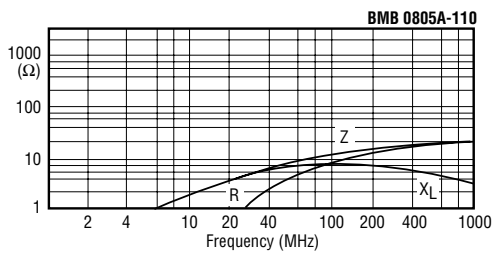

0805 IMPEDANCE VS. FREQUENCY - STANDARD SPEED

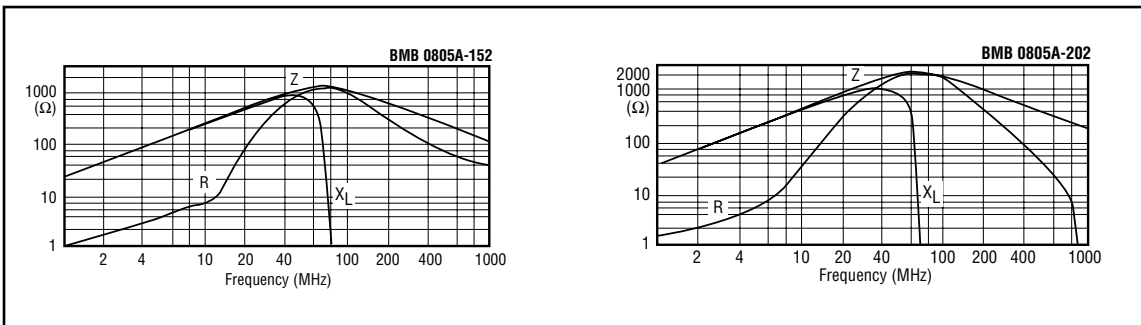

0805 ELECTRICAL CHARACTERISTICS - STANDARD SPEED

Part Number	Impedance $Z \Omega \pm 25\%$ @ 100 MHz	DC Resistance Ω Max.	Rated Current mA Max.
BMB 0805A-070	7	0.06	300
BMB 0805A-110	11	0.06	600
BMB 0805A-170	17	0.06	600
BMB 0805A-260	26	0.06	600
BMB 0805A-320	32	0.06	600
BMB 0805A-400	40	0.15	300
BMB 0805A-600	60	0.15	300
BMB 0805A-800	80	0.15	300
BMB 0805A-900	90	0.15	300
BMB 0805A-121	120	0.15	300
BMB 0805A-151	150	0.15	300
BMB 0805A-181	180	0.20	200
BMB 0805A-221	220	0.20	200
BMB 0805A-301	300	0.20	200
BMB 0805A-401	400	0.30	200
BMB 0805A-601	600	0.30	200
BMB 0805A-102	1000	0.35	100
BMB 0805A-152	1500	0.40	100
BMB 0805A-202	2000	0.50	80
BMB 0805A-222	2200	0.60	80

0805 IMPEDANCE VS. FREQUENCY - HIGH SPEED

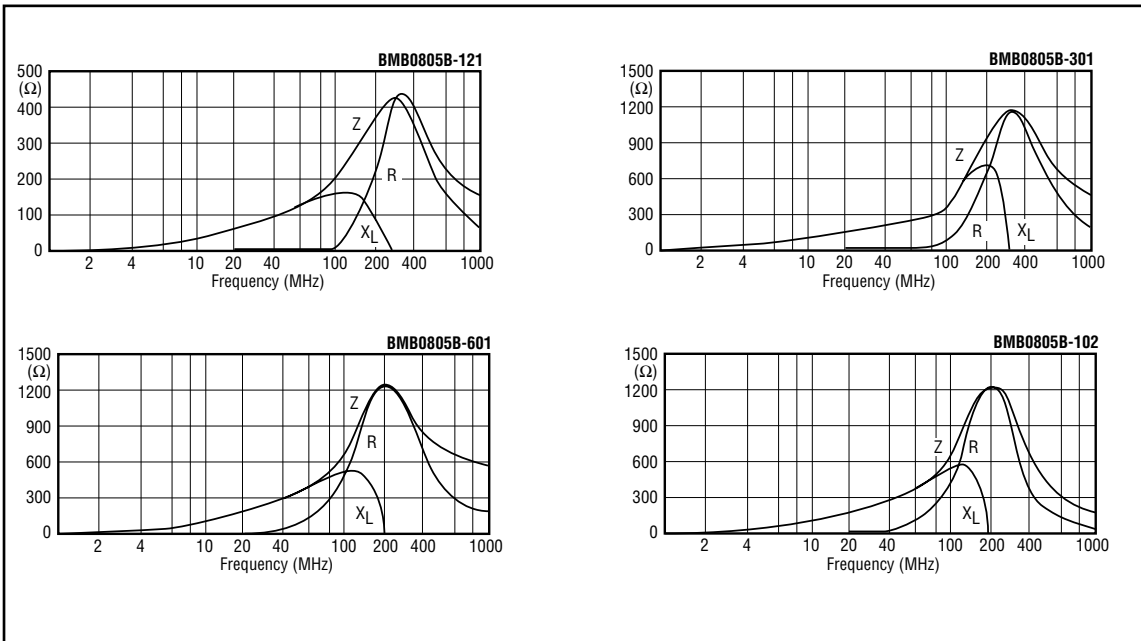

0805 ELECTRICAL CHARACTERISTICS - HIGH SPEED

Part Number	Impedance Z Ω ± 25% @ 100 MHz	DC Resistance Ω Max.	Rated Current mA Max.
BMB 0805B-121	120	0.15	300
BMB 0805B-301	300	0.20	200
BMB 0805B-601	600	0.30	200
BMB 0805B-102	1000	0.35	100



1206 IMPEDANCE VS. FREQUENCY - STANDARD SPEED

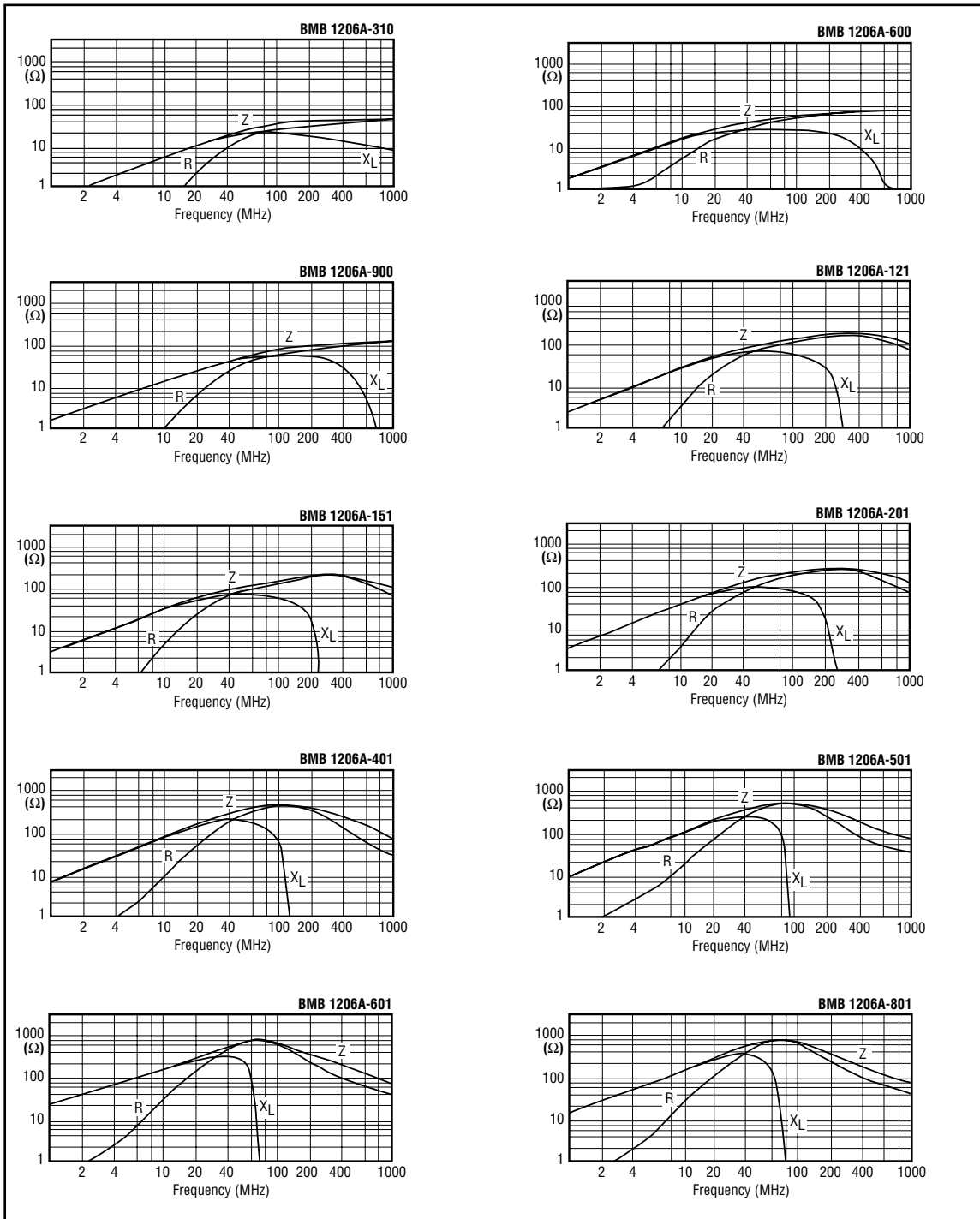

1206 IMPEDANCE VS. FREQUENCY - STANDARD SPEED

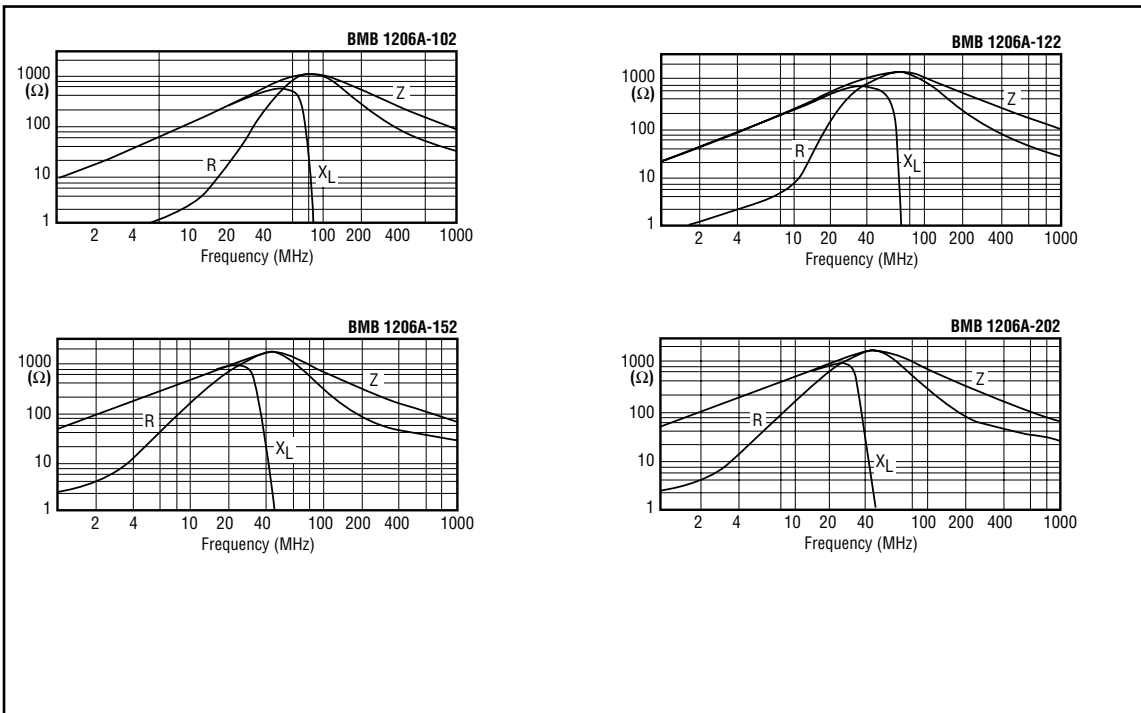

1206 ELECTRICAL CHARACTERISTICS - STANDARD SPEED

Part Number	Impedance $Z \Omega \pm 25\%$ @ 100 MHz	DC Resistance Ω Max.	Rated Current mA Max.
BMB 1206A-260	26	0.08	500
BMB 1206A-310	31	0.08	600
BMB 1206A-500	50	0.08	600
BMB 1206A-600	60	0.10	400
BMB 1206A-700	70	0.10	600
BMB 1206A-900	90	0.15	400
BMB 1206A-121	120	0.15	400
BMB 1206A-151	150	0.15	300
BMB 1206A-201	200	0.20	300
BMB 1206A-401	400	0.20	200
BMB 1206A-501	500	0.25	200
BMB 1206A-601	600	0.30	200
BMB 1206A-801	800	0.30	200
BMB 1206A-102	1000	0.40	200
BMB 1206A-122	1200	0.40	100
BMB 1206A-152	1500	0.50	100
BMB 1206A-202	2000	0.50	100

1206 IMPEDANCE VS. FREQUENCY - HIGH SPEED

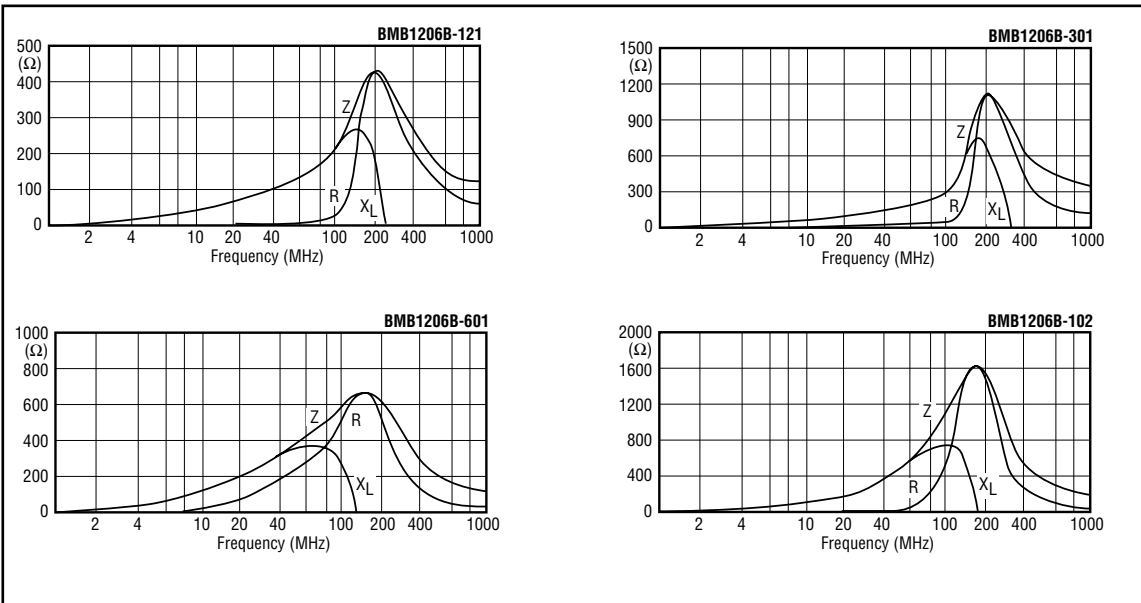

1206 ELECTRICAL CHARACTERISTICS - HIGH SPEED

Part Number	Impedance $Z \Omega \pm 25\%$ @ 100 MHz	DC Resistance Ω Max.	Rated Current mA Max.
BMB 1206B-121	120	0.15	400
BMB 1206B-301	300	0.20	200
BMB 1206B-601	600	0.30	200
BMB 1206B-102	1000	0.40	200

1210 IMPEDANCE VS. FREQUENCY - STANDARD SPEED

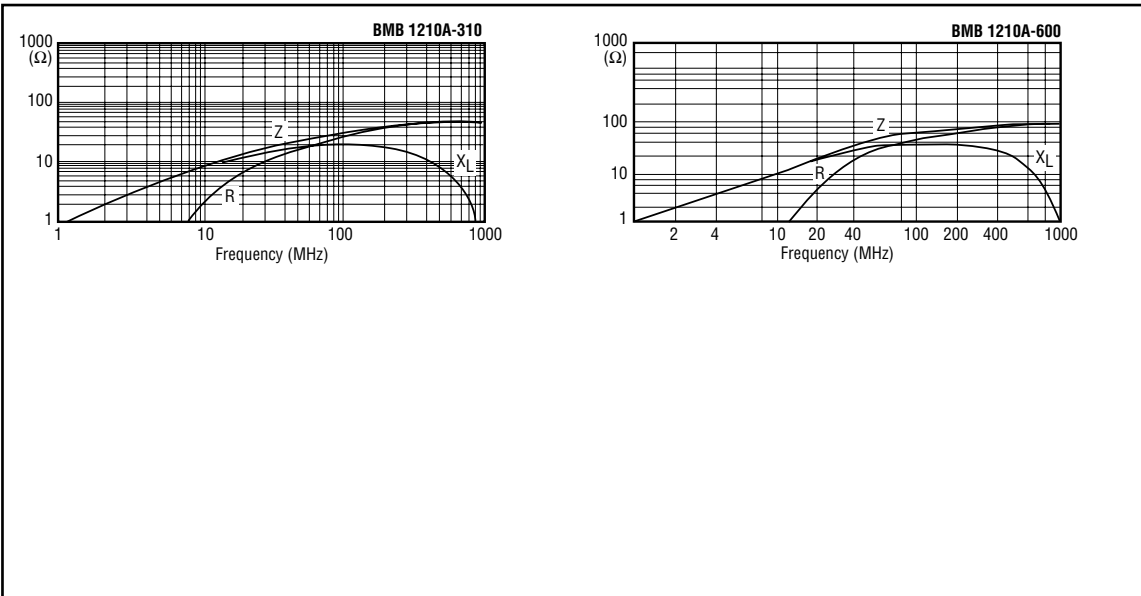

1210 ELECTRICAL CHARACTERISTICS - STANDARD SPEED

Part Number	Impedance $Z \Omega \pm 25\%$ @ 100 MHz	DC Resistance Ω Max.	Rated Current mA Max.
BMB 1210A-310	31	0.3	400
BMB 1210A-600	60	0.3	400
BMB 1210A-900	90	0.3	400

1806 & 1812 IMPEDANCE VS. FREQUENCY - STANDARD SPEED

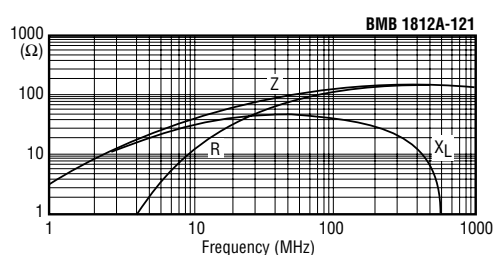
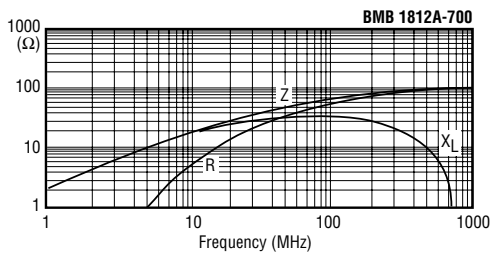
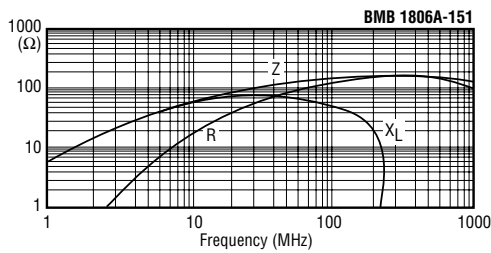
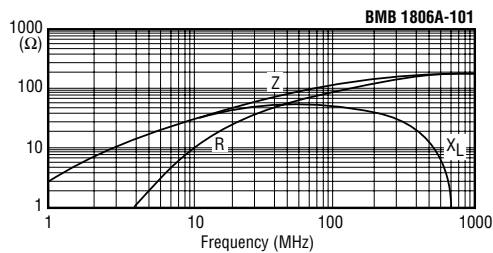
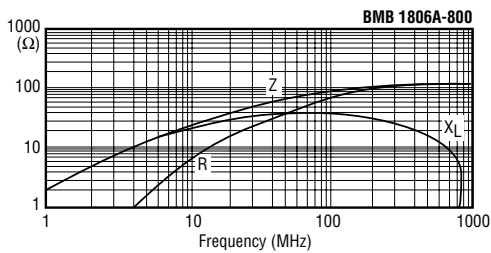

1806 & 1812 ELECTRICAL CHARACTERISTICS - STANDARD SPEED

Part Number	Impedance $Z \Omega \pm 25\%$ @ 100 MHz	DC Resistance Ω Max.	Rated Current mA Max.
BMB 1806A-800	80	0.3	400
BMB 1806A-101	100	0.3	300
BMB 1806A-151	150	0.5	200
BMB 1812A-700	70	0.4	200
BMB 1812A-121	120	0.4	200

PACKAGING (Inch/mm)

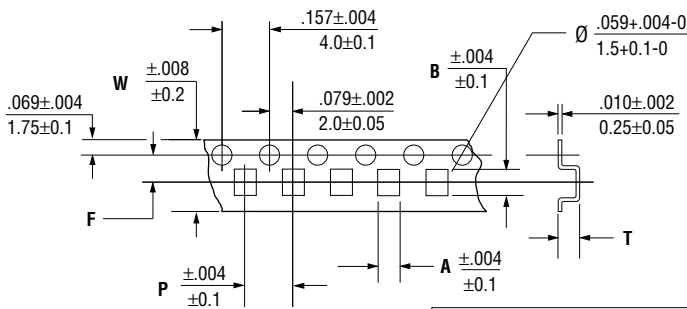

Tape Material: Polystyrene

Part #	A	B	F	W	P	T	7" Reel Diameter (Qty./Reel)
BMB 1812 (4532)	.142 3.60	.193 4.90	.217 5.5	.472 12.0	.315 .08	.075 1.9	1,000
BMB 1806 (4516)	.075 1.90	.193 4.90	.217 5.5	.472 12	.158 .04	.079 2.0	
BMB 1210 (3225)	.114 2.90	.142 3.60	.138 3.5	.315 8	.158 .04	.067 1.7	2,000
BMB 1206 (3216)	.075 1.90	.138 3.50	.138 3.5	.315 8.0	.158 4.0	.059 1.5	
BMB 0805 (2012)	.059 1.5	.091 2.30	.138 3.5	.315 8.0	.158 4.0	.051 1.3	4,000
BMB 0603 (1608)	.047 1.2	.075 1.9	.138 3.5	.315 8.0	.158 4.0	.049 1.25	
BMB 0402 (1005)	.026 0.65	.045 1.15	.138 3.5	.315 8.0	.158 4.0	.032 0.8	6,000

6

OUTLINE DIMENSIONS (Inch/mm)

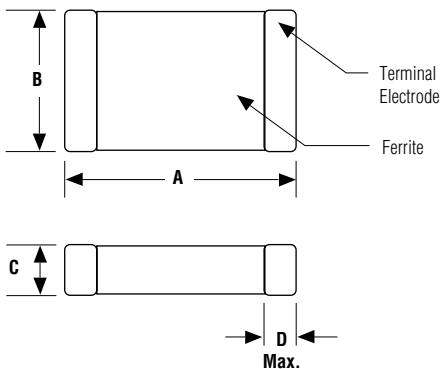

Part #	A Dim.	B Dim.	C Dim.	D Dim.
BMB 0402 (1005)	.04±.007 1.0±.005	.02±.008 .50±.005	.02±.008 .50±.05	.012 .30
BMB 0603 (1608)	.063±.006 1.6±0.15	.031±.006 .80±0.15	.031±.006 .80±0.15	.018 .45
BMB 0805 (2012)	.079±.008 2.0±0.2	.049±.008 1.25±0.2	.035±.008 .90±0.2	.024 .60
BMB 1206 (3216)	.126±.008 3.2±0.2	.063±.008 1.6±0.2	.043±.008 1.1±0.2	.028 .70
BMB 1210 (3225)	.126±.008 3.2±0.2	.098±.008 2.5±0.2	.051±.008 1.3±0.2	.028 .70
BMB 1806 (4516)	.18±.008 4.5±0.2	.063±.008 1.6±0.2	.063±.008 1.6±0.2	.028 .70
BMB 1812 (4532)	.18±.008 4.5±0.2	.126±.008 3.2±0.2	.06±.01 1.5±0.25	.031 .80

ORDERING INFORMATION

