

AIC SERIES

High Energy Storage Chokes for Inverter Applications

www.DataSheet4U.com

Features

Series main characteristics are:

- High efficiency (>99%) due to very low losses design.
- Very good inductance stability vs. temperature.
- Wide inductance range (values of inductance up to 6mH).
- High storage currents (up to 150 A).
- High current density.
- Only one component for 3 phase: Triphasic topology.
- Lower size in comparison with other chokes.
- Operating frequency up to 25kHz.
- Wide operating temperature range.

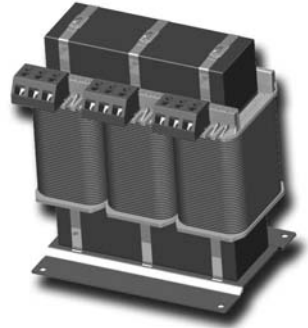

Applications

- Input and output chokes for renewable inverter applications
 - Solar
 - Wind
 - Fuel-cells
- Chokes for welding equipments.
- Input and output chokes for UPS.

PREMO introduces a new high storage mono-phase and three-phase AC chokes standard series for renewable energies, offering a wide range of inductances and Power (from 2,5 up to 100kVA).

AIC series is manufactured with new magnetic material. This new alloy has a balanced performance, combining a high flux density with low coercivity and power losses over a broad range of frequencies making them an ideal solution. This combination of low losses and high saturation flux density provides size reduction and increasingly energy efficiency.

AIC SERIES

High Energy Storage Chokes for Inverter Applications

Product list

Part Number	L ⁽²⁾	Current (A)	Power (kVA)	Fundamental Frequency (Hz)	Ripple Frequency (kHz)	Ripple 15% (Apeak)	Total Losses (W) MAX.	RDC ⁽¹⁾ (mΩ)	ΔT (°C)	η (%)	Weight (Kg)
AIC-2P-300-12	3 mH	12,5	2,5	50 / 60	20	2	25	32	45	99,07	2,1
AIC-2P-600-12	6 mH	12,5	2,5	50 / 60	20	2	30	27	45	98,80	3,6
AIC-2P-150-23	1,5mH	23	5	50 / 60	20	3	25	12	45	99,50	2,9
AIC-2P-250-23	2,5mH	23	5	50 / 60	20	3	30	12	45	99,41	4,1
AIC-2P-300-23	3 mH	23	5	50 / 60	20	3	27,5	12	45	99,47	3,7
AIC-3P-150-15	1,5 mH	15	10	50 / 60	15	2	30	27	40	99,71	3,4
AIC-3P-200-15	2 mH	15	10	50 / 60	15	2	35	22	40	99,67	5
AIC-3P-100-23	1 mH	23	15	50 / 60	15	3	37,5	12	40	99,76	5,2
AIC-3P-200-23	2 mH	23	15	50 / 60	15	3	60	19	40	99,60	8,4
AIC-3P-075-30	750 μH	30	20	50 / 60	15	4	40	6,5	45	99,80	6,3
AIC-3P-150-30	1,5 mH	30	20	50 / 60	15	4	70	10	45	99,66	9,7
AIC-3P-075-36	750 μH	36	25	50 / 60	15	5	67,5	9	45	99,74	7,5
AIC-3P-150-36	1,5 mH	36	25	50 / 60	15	5	110	12	45	99,56	16,2
AIC-3P-032-75	325 μH	75	50	50 / 60	10	11	115	4,5	50	99,77	14,2
AIC-3P-075-75	750 μH	75	50	50 / 60	10	11	160	6	50	99,68	23,7
AIC-3P-025-150	250 μH	150	100	50 / 60	5	23	220	2,5	50	99,79	34,9
AIC-3P-050-150	500 μH	150	100	50 / 60	5	23	210	2,5	50	99,79	45

Note 1: DC Resistance per each phase (mΩ)

Note 2: Total inductance for AIC-2P-XXX-XX.

Inductance per phase for AIC-3P-XXX-XX.

Dimensions (in mm)

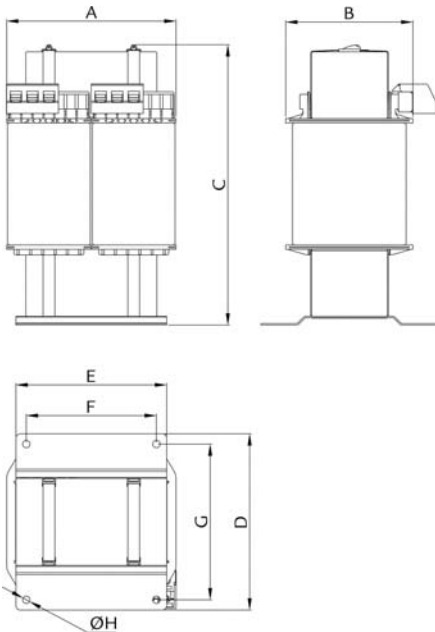

Dimensions of mono-phase chokes

Part Number	A	B	C	D	E	F	G	H
AIC-2P-300-12	120	70	150	85	75	65	75	5
AIC-2P-600-12	120	85	150	100	75	65	90	5
AIC-2P-150-23	120	70	150	85	75	65	75	5
AIC-2P-250-23	120	85	150	100	75	65	90	5
AIC-2P-300-23	120	85	150	100	75	65	90	5

AIC SERIES

High Energy Storage Chokes for Inverter Applications

www.DataSheet4U.com

High Energy Storage Chokes

Dimensions (in mm)

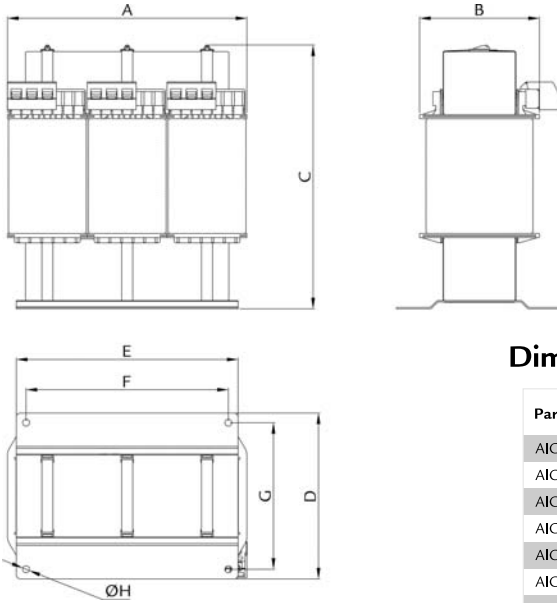

Dimensions of three-phase chokes

Part Number	A	B	C	D	E	F	G	H
AIC-3P-150-15	180	80	150	85	125	115	75	5
AIC-3P-200-15	180	95	150	100	125	115	90	5
AIC-3P-100-23	180	95	150	100	125	115	90	5
AIC-3P-200-23	200	100	180	110	150	140	100	5
AIC-3P-075-30	180	95	150	100	125	115	90	5
AIC-3P-150-30	200	100	180	110	150	140	100	5
AIC-3P-075-36	200	100	180	110	150	140	100	5
AIC-3P-150-36	250	125	210	120	190	180	110	5
AIC-3P-032-75	250	125	210	120	190	180	110	5
AIC-3P-075-75	290	145	245	130	220	210	120	5
AIC-3P-025-150	320	180	270	160	250	240	150	5
AIC-3P-050-150	320	180	270	160	250	240	150	5

Mono-phase graphics

Losses (W) Vs. Temperature (°C)

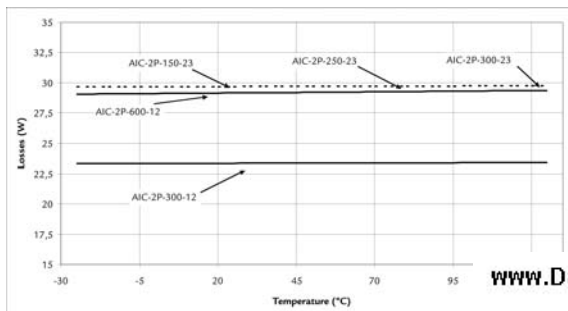

www.DataSheet4U.com

AIC SERIES

High Energy Storage Chokes for Inverter Applications

www.DataSheet4U.com

Core Losses (W) Vs. Frequency (kHz)

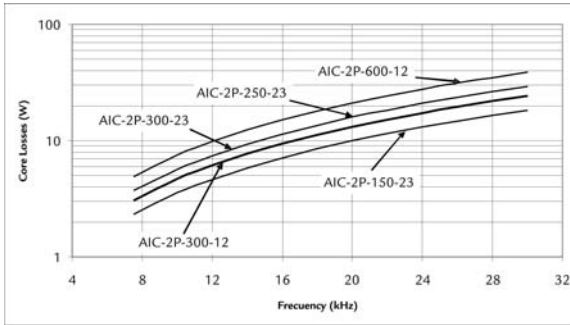

Three-phase graphics

Losses (W) Vs. Temperature (°C)

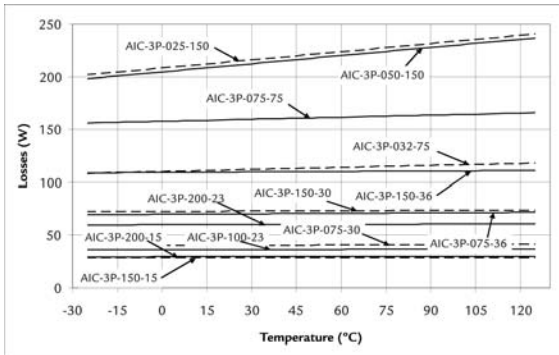

Core Losses (W) Vs. Frequency (kHz)

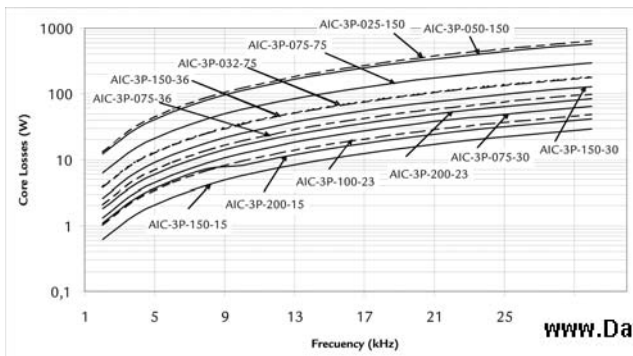

www.DataSheet4U.com