

Solid Tantalum Chip Capacitors

TANTAMOUNT[®], Commercial, Surface Mount



FEATURES

- Molded case available in six case codes.
- Compatible with "High Volume" automatic pick and place equipment.
- Optical character recognition qualified.
- Meets IEC Specification QC300801/US0001 and EIA 535BAAC.

PERFORMANCE/ELECTRICAL CHARACTERISTICS

Operating Temperature: - 55°C to + 85°C. (to + 125°C with voltage derating.)

Capacitance Range: 0.10μF to 680μF.

Capacitance Tolerance: ± 20%, ± 10% standard. (20% only on P)

Compliant Terminations

100% Surge Current Tested (D & E Case Codes).

Voltage Rating: 4 WVDC to 50 WVDC.

OTHER SPECIFICATIONS

CECC

30801-005

30801-009

30801-011

30801-801

IECQ

PQC32/GB003

300801/FR001

CTC3

CTC4

793DX

CTC3

ORDERING INFORMATION

293D TYPE	107 CAPACITANCE	X9 CAPACITANCE TOLERANCE	010 DC VOLTAGE RATING @ + 85°C	D CASE CODE	2 TERMINATION	W REEL SIZE AND PACKAGING
793DX 793DE CTC3 CTC4	This is expressed in picofarads. The first two digits are the significant figures. The third is the number of zeros to follow.	X0 = ± 20% X9 = ± 10% X5 = ± 5% (Special Order)	This is expressed in volts. To complete the three-digit block, zeros precede the voltage rating. A decimal point is indicated by an "R" (6R3 = 6.3 volts).	See Ratings and Case Code Tables.	2 = Solderable coating. Standard.	T = 7" [178mm] reel,* W = 13" [330mm] reel* *cathode nearest sprocket hole.

Note: Preferred Tolerance and reel sizes are in bold.

We reserve the right to supply higher voltage ratings and tighter capacitance tolerance capacitors in the same case size. Voltage substitutions will be marked with the higher voltage rating.

DIMENSIONS in inches [millimeters]

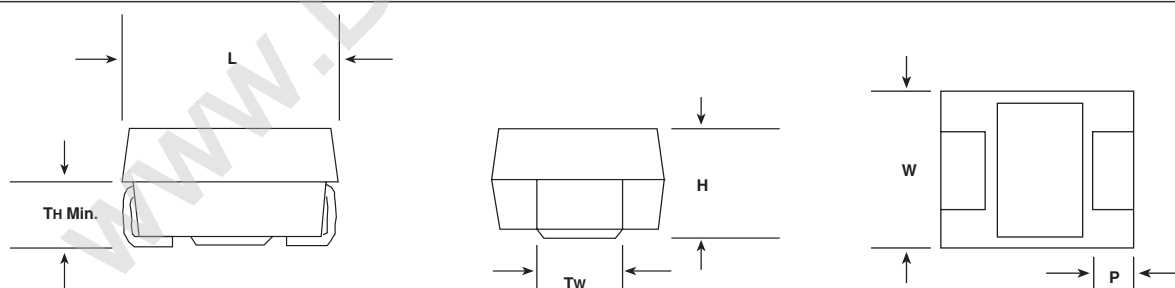

CASE CODE	EIA SIZE	L	W	H	P	TW	TH (Min.)
A	3216	0.126 ± 0.008 [3.2 ± 0.20]	0.063 ± 0.008 [1.6 ± 0.20]	0.063 ± 0.008 [1.6 ± 0.20]	0.031 ± 0.012 [0.80 ± 0.30]	0.047 ± 0.004 [1.2 ± 0.10]	0.028 [0.70]
B	3528	0.138 ± 0.008 [3.5 ± 0.20]	0.110 ± 0.008 [2.8 ± 0.20]	0.075 ± 0.008 [1.9 ± 0.20]	0.031 ± 0.012 [0.80 ± 0.30]	0.087 ± 0.004 [2.2 ± 0.10]	0.028 [0.70]
C	6032	0.236 ± 0.012 [6.0 ± 0.30]	0.126 ± 0.012 [3.2 ± 0.30]	0.098 ± 0.012 [2.5 ± 0.30]	0.051 ± 0.012 [1.3 ± 0.30]	0.087 ± 0.004 [2.2 ± 0.10]	0.039 [1.0]
D	7343	0.287 ± 0.012 [7.3 ± 0.30]	0.170 ± 0.012 [4.3 ± 0.30]	0.110 ± 0.012 [2.8 ± 0.30]	0.051 ± 0.012 [1.3 ± 0.30]	0.095 ± 0.004 [2.4 ± 0.10]	0.039 [1.0]
E	7343H	0.287 ± 0.012 [7.3 ± 0.30]	0.170 ± 0.012 [4.3 ± 0.30]	0.158 ± 0.012 [4.0 ± 0.30]	0.051 ± 0.012 [1.3 ± 0.30]	0.095 ± 0.004 [2.4 ± 0.10]	0.039 [1.0]
P	2012	0.079 ± 0.20 [2.0 ± 0.008]	0.049 ± 0.008 [1.25 ± 0.2]	0.047 Max. [1.2 Max.]	0.020 ± 0.008 [0.52 ± 0.20]	0.047 ± 0.004 [1.2 ± 0.10]	0.012 [0.3]

RATINGS AND CASE CODES

μF	4 V		6.3 V		10 V		16 V		20 V		25 V		35 V		50 V	
	Std.	Ext.	Std.	Ext.	Std.	Ext.	Std.	Ext.	Std.	Ext.	Std.	Ext.	Std.	Ext.	Std.	Ext.
0.10													A		A	
0.15													A		B	A
0.22													A		B	A
0.33													A		B	A
0.47												A	B	A	B/C	A
0.68									A		A		B	A	C	B
1.0					P		A/P		A		B	A	B	A	C	B
1.5					A		A		A		B	A	C	B		C
2.2			A		A/P		A/B		B	A	B	A	C	B	D	C/D
3.3	A		A/P		A/P		A/B		B	A	C	B	C	B	D	C
4.7	A		A/B/P		A/B/P		B	A	B/C	A	C	B	D	C	D	
6.8	A		A/B/P		B	A	B/C	A	C	B	C	B	D	C		D/E
10	A/B/P		B/C/P	A	B/C	A	C	A/B	C	B	D	C	D	C		D/E
15	B/P	A	B/C	A	C	A/B	C	B	D	B/C	D	C		D/E		
22	B/C/P	A	C	A/B	C	A/B	D	B/C	D	C		D		D/E		
33	C	A/B	C	A*/B	D	B/C	D	B/C	D	C		D/E		E*		
47	C	A*/B	D	B/C	D	B/C	D	C		D/E		E*				
68	D	B/C	D	B/C	D	B*/C		D		D/E						
100	D	B/C	D	B/C		C/D		D/E		E						
150	D	B/C	E	C/D		D/E		D*/E								
220	E	C/D		D/E		D/E										
330		D/E		D/E		E										
470		D/E		E												
680		E														

*Preliminary values, contact factory for availability.

CONSTRUCTION AND MARKING

CONSTRUCTION

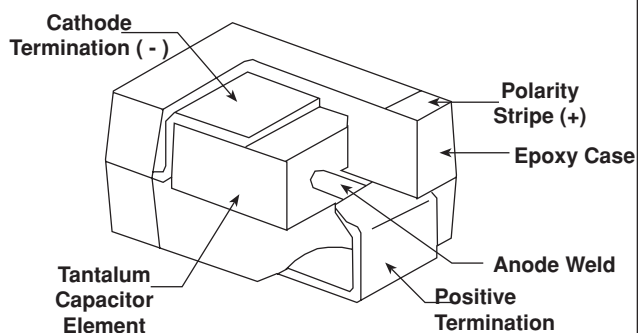

MARKING

Capacitance Code, Voltage pF, Vishay Sprague Logo, Polarity Band, Capacitance, Voltage Code, Voltage, "A" Case Polarity Band, Date Code, Vishay Sprague Logo, "P" Case Polarity Band.

Volts	Code
4	G
6.3	J
10	A
16	C
20	D

Marking:

Capacitor marking will include an anode (+) polarity band, capacitance in microfarads and the voltage rating of + 85°C. 'A' Case capacitors use a letter code for the voltage and EIA capacitance code.

The Sprague® trademark may be included if space permits.

Units rated at 6.3 V shall be marked 6 V.

A manufacturing date code is marked on all case codes. Call the factory for further explanation.



STANDARD/EXTENDED RATINGS							
CAPACITANCE (μF)	CASE CODE	PART NUMBER	Max. DC Leakage @ + 25°C (μA)	Max. DF @ + 25°C 120 Hz (%)	Max. ESR @ + 25°C 100kHz (Ohms)	Max. RIPPLE 100kHz Irms (Amps)	
4 WVDC @ + 85°C, SURGE = 5.2 V ... 2.7 WVDC @ + 125°C, SURGE = 3.4 V							
3.3	A	293D335X_004A2	0.5	6	7.6	0.10	
4.7	A	293D475X_004A2	0.5	6	6.3	0.11	
6.8	A	293D685X_004A2	0.5	6	5.5	0.12	
10	A	293D106X_004A2	0.5	6	5.1	0.12	
10	B	293D106X_004B2	0.5	6	3.5	0.16	
10	P	293D106X_004P2	0.5	6	N/A	0.085	
15	A	293D156X_004A2	0.6	6	3.4	0.15	
15	B	293D156X_004B2	0.6	6	2.9	0.17	
15	P	293D156X_004P2	0.6	6	N/A	0.085	
22	A	293D226X_004A2	0.9	6	2.9	0.16	
22	B	293D226X_004B2	0.9	6	2.5	0.18	
22	C	293D226X_004C2	0.9	6	1.8	0.25	
22	P	293D226X_004P2	0.9	6	N/A	0.085	
33	A	293D336X_004A2	1.3	6	2.9	0.16	
33	B	293D336X_004B2	1.3	6	2.0	0.21	
33	C	293D336X_004C2	1.3	6	1.8	0.25	
47	B	293D476X_004B2	1.9	6	1.9	0.21	
47	C	293D476X_004C2	1.9	6	1.8	0.25	
68	B	293D686X_004B2	2.7	6	1.9	0.21	
68	C	293D686X_004C2	2.7	6	1.4	0.28	
68	D	293D686X_004D2	2.7	6	0.8	0.43	
100	B	293D107X_004B2	4.0	8	1.8	0.22	
100	C	293D107X_004C2	4.0	6	0.8	0.37	
100	D	293D107X_004D2	4.0	6	0.7	0.46	
150	B	293D157X_004B2	6.0	14	1.6	0.23	
150	C	293D157X_004C2	6.0	12	0.7	0.40	
150	D	293D157X_004D2	6.0	8	0.6	0.50	
220	C	293D227X_004C2	8.8	8	0.7	0.40	
220	D	293D227X_004D2	8.8	8	0.6	0.50	
220	E	293D227X_004E2	8.8	8	0.5	0.57	
330	D	293D337X_004D2	13.2	8	0.6	0.50	
330	E	293D337X_004E2	13.2	8	0.5	0.57	
470	D	293D477X_004D2	18.8	10	0.6	0.50	
470	E	293D477X_004E2	18.8	10	0.5	0.57	
680	E	293D687X_004E2	27.2	12	0.5	0.57	
6.3 WVDC @ + 85°C, SURGE = 8 V ... 4 WVDC @ + 125°C, SURGE = 5 V							
2.2	A	293D225X_6R3A2	0.5	6	7.6	0.10	
3.3	A	293D335X_6R3A2	0.5	6	6.3	0.11	
3.3	P	293D335X_6R3P2	0.5	6	N/A	0.085	
4.7	A	293D475X_6R3A2	0.5	6	5.5	0.12	
4.7	P	293D475X_6R3P2	0.5	6	N/A	0.085	
6.8	A	293D685X_6R3A2	0.5	6	5.0	0.12	
6.8	B	293D685X_6R3B2	0.5	6	3.4	0.16	
6.8	P	293D685X_6R3P2	0.5	6	N/A	0.085	
10	A	293D106X_6R3A2	0.6	6	3.4	0.15	
10	B	293D106X_6R3B2	0.6	6	2.9	0.17	
10	P	293D106X_6R3P2	0.6	6	N/A	0.085	
15	A	293D156X_6R3A2	0.9	6	2.9	0.16	
15	B	293D156X_6R3B2	0.9	6	2.5	0.18	
15	C	293D156X_6R3C2	0.9	6	1.8	0.25	
22	A	293D226X_6R3A2	1.3	6	2.9	0.16	
22	B	293D226X_6R3B2	1.3	6	2.0	0.21	
22	C	293D226X_6R3C2	1.3	6	1.8	0.25	
33	B	293D336X_6R3B2	2.0	6	1.9	0.21	
33	C	293D336X_6R3C2	2.0	6	1.5	0.27	
47	B	293D476X_6R3B2	2.8	6	1.9	0.21	
47	C	293D476X_6R3C2	2.8	6	1.4	0.28	
47	D	293D476X_6R3D2	2.8	6	0.8	0.43	
68	B	293D686X_6R3B2	4.1	6	1.8	0.22	
68	C	293D686X_6R3C2	4.1	6	0.8	0.37	
68	D	293D686X_6R3D2	4.1	6	0.7	0.46	
100	B	293D107X_6R3B2	6.0	12	1.7	0.22	
100	C	293D107X_6R3C2	6.0	6	0.8	0.37	
100	D	293D107X_6R3D2	6.0	6	0.7	0.46	
150	C	293D157X_6R3C2	9.0	8	0.7	0.40	
150	D	293D157X_6R3D2	9.0	8	0.6	0.50	
150	E	293D157X_6R3E2	9.0	8	0.5	0.57	
220	D	293D227X_6R3D2	13.2	8	0.6	0.50	
220	E	293D227X_6R3E2	13.2	8	0.5	0.57	
330	D	293D337X_6R3D2	19.8	8	0.6	0.50	
330	E	293D337X_6R3E2	19.8	8	0.5	0.57	
470	E	293D477X_6R3E2	28.2	10	0.5	0.57	

*Preliminary values, contact factory for availability. For 10% tolerance, specify "9"; for 20% tolerance, change to "0". **Extended Range ratings in bold print.**



STANDARD/EXTENDED RATINGS

CAPACITANCE (μ F)	CASE CODE	PART NUMBER	Max. DC Leakage @ + 25°C (μ A)	Max. DF @ + 25°C 120 Hz (%)	Max. ESR @ + 25°C 100kHz (Ohms)	Max. RIPPLE 100kHz Irms (Amps)
10 WVDC @ + 85°C, SURGE = 13 V . . . 7 WVDC @ + 125°C, SURGE = 8 V						
1.0	P	293D105X_010P2	0.5	6	N/A	0.07
1.5	A	293D155X_010A2	0.5	6	8.0	0.10
2.2	A	293D225X_010A2	0.5	6	6.3	0.11
2.2	P	293D225X_010P2	0.5	6	N/A	0.07
3.3	A	293D335X_010A2	0.5	6	5.5	0.12
3.3	P	293D335X_010P2	0.5	6	N/A	0.07
4.7	A	293D475X_010A2	0.5	6	5.0	0.12
4.7	B	293D475X_010B2	0.5	6	3.4	0.16
4.7	P	293D475X_010P2	0.5	6	N/A	0.07
6.8	A	293D685X_010A2	0.7	6	4.2	0.13
6.8	B	293D685X_010B2	0.7	6	2.9	0.17
10	A	293D106X_010A2	1.0	6	3.4	0.15
10	B	293D106X_010B2	1.0	6	2.5	0.18
10	C	293D106X_010C2	1.0	6	1.8	0.25
15	A	293D156X_010A2	1.5	6	2.9	0.16
15	B	293D156X_010B2	1.5	6	2.0	0.21
15	C	293D156X_010C2	1.5	6	1.8	0.25
22	A	293D226X_010A2	2.2	8	2.5	0.17
22	B	293D226X_010B2	2.2	6	1.9	0.21
22	C	293D226X_010C2	2.2	6	1.5	0.27
33	B	293D336X_010B2	3.3	6	1.9	0.21
33	C	293D336X_010C2	3.3	6	1.4	0.28
33	D	293D336X_010D2	3.3	6	0.8	0.43
47	B	293D476X_010B2	4.7	6	1.8	0.22
47	C	293D476X_010C2	4.7	6	1.1	0.32
47	D	293D476X_010D2	4.7	6	0.7	0.46
68	C	293D686X_010C2	6.8	6	1.0	0.33
68	D	293D686X_010D2	6.8	6	0.7	0.46
100	C	293D107X_010C2	10	8	0.9	0.35
100	D	293D107X_010D2	10	8	0.6	0.50
150	D	293D157X_010D2	15	8	0.6	0.50
150	E	293D157X_010E2	15	8	0.5	0.57
220	D	293D227X_010D2	22	8	0.6	0.50
220	E	293D227X_010E2	22	8	0.5	0.57
330	E	293D337X_010E2	33	10	0.5	0.57
16 WVDC @ + 85°C, SURGE = 20 V . . . 10 WVDC @ + 125°C, SURGE = 12 V						
1.0	A	293D105X_016A2	0.5	4	9.3	0.09
1.0	P	293D105X_016P2	0.5	4	N/A	0.07
1.5	A	293D155X_016A2	0.5	6	6.7	0.11
2.2	A	293D225X_016A2	0.5	6	5.9	0.11
2.2	B	293D225X_016B2	0.5	6	4.6	0.14
3.3	A	293D335X_016A2	0.5	6	5.0	0.12
3.3	B	293D335X_016B2	0.5	6	3.5	0.16
4.7	A	293D475X_016A2	0.8	6	5.0	0.12
4.7	B	293D475X_016B2	0.8	6	2.9	0.17
6.8	A	293D685X_016A2	1.1	6	4.2	0.13
6.8	B	293D685X_016B2	1.1	6	2.5	0.18
6.8	C	293D685X_016C2	1.1	6	1.9	0.24
10	A	293D106X_016A2	1.6	6	3.0	0.16
10	B	293D106X_016B2	1.6	6	2.0	0.21
10	C	293D106X_016C2	1.6	6	1.8	0.25
15	B	293D156X_016B2	2.4	6	2.0	0.21
15	C	293D156X_016C2	2.4	6	1.5	0.27
22	B	293D226X0016B2	3.5	6	1.9	0.21
22	C	293D226X_016C2	3.5	6	1.4	0.28
22	D	293D226X_016D2	3.5	6	0.8	0.43
33	B	293D336X0016B2	5.3	6	1.8	0.22
33	C	293D336X_016C2	5.3	6	1.1	0.32
33	D	293D336X_016D2	5.3	6	0.7	0.46
47	C	293D476X_016C2	7.5	6	1.0	0.33
47	D	293D476X_016D2	7.5	6	0.7	0.46
68	D	293D686X_016D2	10.9	6	0.6	0.50
100	D	293D107X_016D2	16	8	0.6	0.50
100	E	293D107X_016E2	16	8	0.6	0.52
150	E	293D157X_016E2	24	8	0.5	0.57

*Preliminary values, contact factory for availability. For 10% tolerance, specify "9"; for 20% tolerance, change to "0". **Extended Range ratings in bold print.**



STANDARD/EXTENDED RATINGS						
CAPACITANCE (μ F)	CASE CODE	PART NUMBER	Max. DC Leakage @ + 25°C (μ A)	Max. DF @ + 25°C 120 Hz (%)	Max. ESR @ + 25°C 100kHz (Ohms)	Max. RIPPLE 100kHz Irms (Amps)
20 WVDC @ + 85°C, SURGE = 26 V . . . 13 WVDC @ + 125°C, SURGE = 16 V						
0.68	A	293D684X_020A2_	0.5	4	10	0.09
1.0	A	293D105X_020A2_	0.5	4	8.4	0.09
1.5	A	293D155X_020A2_	0.5	6	6.3	0.11
2.2	A	293D225X_020A2_	0.5	6	5.9	0.11
2.2	B	293D225X_020B2_	0.5	6	3.5	0.16
3.3	A	293D335X_020A2_	0.7	6	5.9	0.11
3.3	B	293D335X_020B2_	0.7	6	3.0	0.17
4.7	A	293D475X_020A2_	0.9	6	5.0	0.12
4.7	B	293D475X_020B2_	0.9	6	2.9	0.17
4.7	C	293D475X_020C2_	0.9	6	2.3	0.22
6.8	B	293D685X_020B2_	1.4	6	2.5	0.18
6.8	C	293D685X_020C2_	1.4	6	1.9	0.24
10	B	293D106X_020B2_	2.0	6	2.5	0.18
10	C	293D106X_020C2_	2.0	6	1.7	0.25
15	B	293D156X_020B2_	3.0	6	2.3	0.19
15	C	293D156X_020C2_	3.0	6	1.5	0.27
15	D	293D156X_020D2_	3.0	6	0.9	0.41
22	C	293D226X_020C2_	4.4	6	1.1	0.32
22	D	293D226X_020D2_	4.4	6	0.7	0.46
33	C	293D336X_020C2_	6.6	6	1.0	0.33
33	D	293D336X_020D2_	6.6	6	0.7	0.46
47	D	293D476X_020D2_	9.4	6	0.7	0.46
47	E	293D476X_020E2_	9.4	6	0.6	0.52
68	D	293D686X_020D2_	13.6	6	0.7	0.46
68	E	293D686X_020E2_	13.6	6	0.6	0.52
100	E	293D107X_020E2_	20.0	8	0.5	0.57
25 WVDC @ + 85°C, SURGE = 32 V . . . 17 WVDC @ + 125°C, SURGE = 20 V						
0.47	A	293D474X_025A2_	0.5	4	12	0.08
0.68	A	293D684X_025A2_	0.5	4	8.4	0.09
1.0	A	293D105X_025A2_	0.5	4	7.6	0.10
1.0	B	293D105X_025B2_	0.5	4	5.0	0.13
1.5	A	293D155X_025A2_	0.5	6	6.7	0.11
1.5	B	293D155X_025B2_	0.5	6	4.6	0.14
2.2	A	293D225X_025A2_	0.6	6	6.3	0.11
2.2	B	293D225X_025B2_	0.6	6	3.8	0.15
3.3	B	293D335X_025B2_	0.8	6	3.1	0.17
3.3	C	293D335X_025C2_	0.8	6	2.3	0.22
4.7	B	293D475X_025B2_	1.2	6	2.8	0.17
4.7	C	293D475X_025C2_	1.2	6	2.0	0.24
6.8	B	293D685X_025B2_	1.7	6	2.4	0.19
6.8	C	293D685X_025C2_	1.7	6	1.7	0.25
10	C	293D106X_025C2_	2.5	6	1.5	0.27
10	D	293D106X_025D2_	2.5	6	1.0	0.39
15	C	293D156X_025C2_	3.8	6	1.2	0.30
15	D	293D156X_025D2_	3.8	6	0.8	0.43
22	D	293D226X_025D2_	5.5	6	0.7	0.46
33	D	293D336X_025D2_	8.3	6	0.7	0.46
33	E	293D336X_025E2_	8.3	6	0.6	0.52

Preliminary values, contact factory for availability. For 10% tolerance, specify "9"; for 20% tolerance, change to "0". **Extended Range ratings in bold print.

STANDARD/EXTENDED RATINGS

CAPACITANCE (μ F)	CASE CODE	PART NUMBER	Max. DC Leakage @ + 25°C (μ A)	Max. DF @ + 25°C 120 Hz (%)	Max. ESR @ + 25°C 100kHz (Ohms)	Max. RIPPLE 100kHz I _{rms} (Amps)
35 WVDC @ + 85°C, SURGE = 46 V . . . 23 WVDC @ + 125°C, SURGE = 28 V						
0.10	A	293D104X_035A2_	0.5	4	20	0.06
0.15	A	293D154X_035A2_	0.5	4	18	0.07
0.22	A	293D224X_035A2_	0.5	4	15	0.07
0.33	A	293D334X_035A2_	0.5	4	13	0.08
0.47	A	293D474X_035A2_	0.5	4	10	0.09
0.47	B	293D474X_035B2_	0.5	4	8	0.10
0.68	A	293D684X_035A2_	0.5	4	7.6	0.10
0.68	B	293D684X_035B2_	0.5	4	6.5	0.11
1.0	A	293D105X_035A2_	0.5	4	7.5	0.10
1.0	B	293D105X_035B2_	0.5	4	5.0	0.13
1.5	B	293D155X_035B2_	0.5	6	4.2	0.14
1.5	C	293D155X_035C2_	0.5	6	3.8	0.17
2.2	B	293D225X_035B2_	0.8	6	3.8	0.15
2.2	C	293D225X_035C2_	0.8	6	2.9	0.20
3.3	B	293D335X_035B2_	1.2	6	3.5	0.16
3.3	C	293D335X_035C2_	1.2	6	2.1	0.23
4.7	C	293D475X_035C2_	1.6	6	1.9	0.24
4.7	D	293D475X_035D2_	1.6	6	1.3	0.34
6.8	C	293D685X_035C2_	2.4	6	1.8	0.25
6.8	D	293D685X_035D2_	2.4	6	1.1	0.37
10	C	293D106X_035D2_	3.5	6	0.7	0.46
10	D	293D106X_035D2_	3.5	6	0.8	0.43
15	D	293D156X_035D2_	5.3	6	0.7	0.46
15	E	293D156X_035E2_	5.3	6	0.7	0.49
22	D	293D226X_035D2_	7.7	6	0.6	0.52
22	E	293D226X_035E2_	7.7	6	0.6	0.52
50 WVDC @ + 85°C, SURGE = 65 V . . . 33 WVDC @ + 125°C, SURGE = 40 V						
0.10	A	293D104X_050A2_	0.5	4	19	0.06
0.15	A	293D154X_050A2_	0.5	4	17	0.07
0.15	B	293D154X_050B2_	0.5	4	14	0.08
0.22	A	293D224X_050A2_	0.5	4	15	0.07
0.22	B	293D224X_050B2_	0.5	4	12	0.08
0.33	A	293D334X_050A2_	0.5	4	14	0.07
0.33	B	293D334X_050B2_	0.5	4	10	0.09
0.47	A	293D474X_050A2_	0.5	4	12	0.08
0.47	B	293D474X_050B2_	0.5	4	8.4	0.10
0.47	C	293D474X_050C2_	0.5	4	6.7	0.13
0.68	B	293D684X_050B2_	0.5	4	7.6	0.11
0.68	C	293D684X_050C2_	0.5	4	5.9	0.14
1.0	B	293D105X_050B2_	0.5	4	6.7	0.11
1.0	C	293D105X_050C2_	0.5	4	4.6	0.16
1.5	C	293D155X_050C2_	0.8	6	3.4	0.18
2.2	C	293D225X_050C2_	1.1	6	2.9	0.20
2.2	D	293D225X_050D2_	1.1	6	2.1	0.27
3.3	C	293D335X_050C2_	1.7	6	2.5	0.21
3.3	D	293D335X_050D2_	1.7	6	1.7	0.30
4.7	D	293D475X_050D2_	2.4	6	1.2	0.37
6.8	D	293D685X_050D2_	3.4	6	0.9	0.41
6.8	E	293D685X_050E2_	3.4	6	0.9	0.43
10	D	293D106X_050D2_	5.0	6	0.8	0.43
10	E	293D106X_050E2_	5.0	6	0.8	0.45

Preliminary values, contact factory for availability. For 10% tolerance, specify "9"; for 20% tolerance, change to "0". **Extended Range ratings in bold print.

TYPICAL CURVES @ + 25°C, IMPEDANCE AND ESR vs FREQUENCY

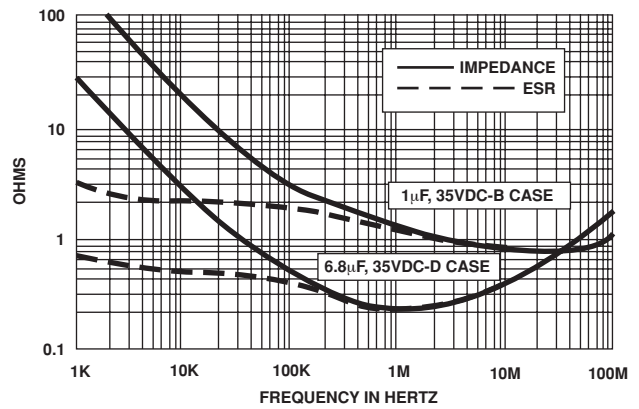
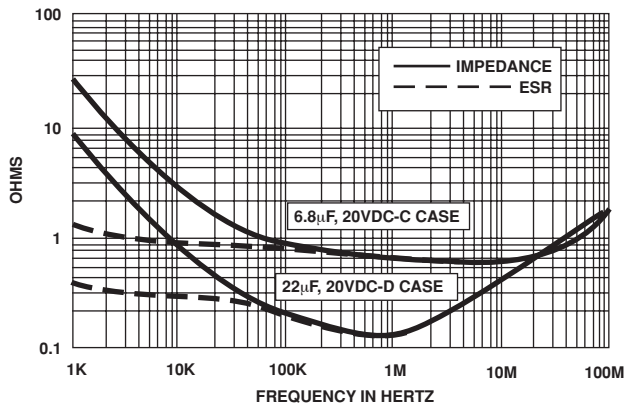
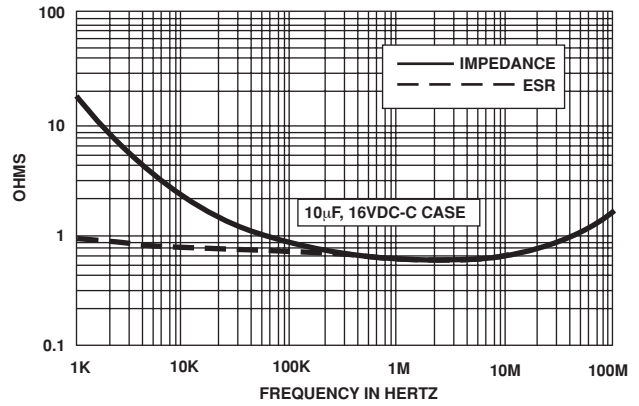
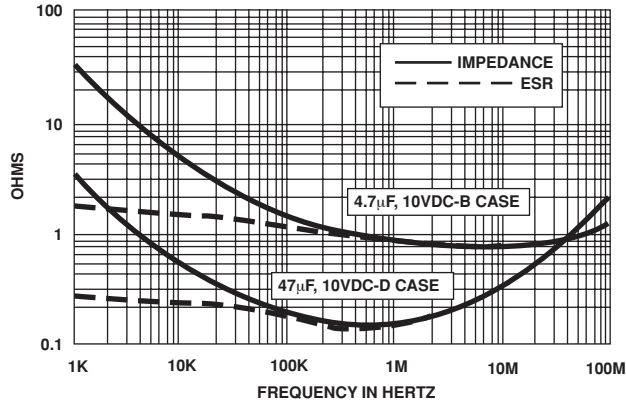



PERFORMANCE CHARACTERISTICS

- 1. **Operating Temperature:** Capacitors are designed to operate over the temperature range - 55°C to + 85°C.
- 1.1 Capacitors may be operated to + 125°C with voltage derating to two-thirds the + 85°C rating.

+ 85°C Rating		+ 125°C Rating	
Working Voltage (V)	Surge Voltage (V)	Working Voltage (V)	Surge Voltage (V)
4	5.2	2.7	3.4
6.3	8	4	5
10	13	7	8
16	20	10	12
20	26	13	16
25	32	17	20
35	46	23	28
50	65	33	40

- 2. **DC Working Voltage:** The DC working voltage is the maximum operating voltage for continuous duty at the rated temperature.
- 3. **Surge Voltage:** The surge DC rating is the maximum voltage to which the capacitors may be subjected under any conditions, including transients and peak ripple at the highest line voltage.
- 3.1 **Surge Voltage Test:** Capacitors shall withstand the surge voltage applied in series with a 33 ohm ± 5% resistor at the rate of one-half minute on, one-half minute off, at + 85°C, for 1000 successive test cycles.
- 3.2 Following the surge voltage test, the dissipation factor and the leakage current shall meet the initial requirements; the capacitance shall not have changed more than ± 10%.
- 4. **Capacitance Tolerance:** The capacitance of all capacitors shall be within the specified tolerance limits of the normal rating.
- 4.1 Capacitance measurements shall be made by means of polarized capacitance bridge. The polarizing voltage shall be of such magnitude that there shall be no reversal of polarity due to the AC component. The maximum voltage applied to capacitors during measurement shall be 2 volts rms at 120 Hz at +25°C. If the AC voltage applied is less than one-half volt rms, no DC bias is required. Accuracy of the bridge shall be within ± 2%.

- 5. **Capacitance Change With Temperature:** The capacitance change with temperature shall not exceed the following percentage of the capacitance measured at + 25°C:

- 55°C	+ 85°C	+ 125°C
- 10%	+ 10%	+ 12%

- 6. **Dissipation Factor:** The dissipation factor, determined from the expression $2\pi fRC$, shall not exceed values listed in the Standard Ratings Table.
- 6.1 Measurements shall be made by the bridge method at, or referred to, a frequency of 120 Hz and a temperature of + 25°C.
- 7. **Leakage Current:** Capacitors shall be stabilized at the rated temperature for 30 minutes. Rated voltage shall be applied to capacitors for 5 minutes using a steady source of power (such as a regulated power supply) with 1000 ohm resistor connected in series with the capacitor under test to limit the charging current. Leakage current shall then be measured.

Note that the leakage current varies with temperature and applied voltage. See graph below for the appropriate adjustment factor.

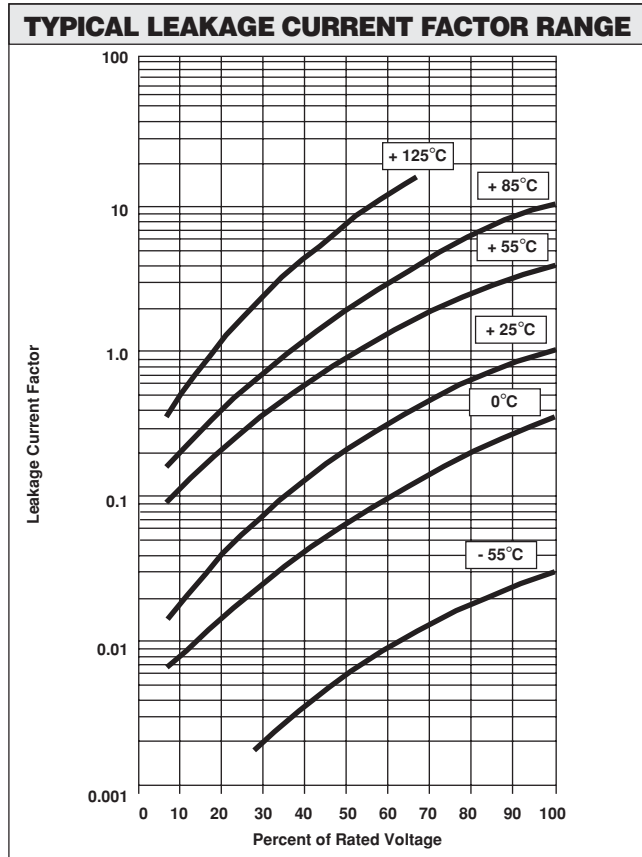

PERFORMANCE CHARACTERISTICS (Continued)

- 7.1 At + 25°C, the leakage current shall not exceed the value listed in the Standard Ratings Table.
- 7.2 At + 85°C, the leakage current shall not exceed 10 times the value listed in the Standard Ratings Table.
- 7.3 At + 125°C, the leakage current shall not exceed 12 times the value listed in the Standard Ratings Table.
8. **ESR**
- 8.1 **ESR (Equivalent Series Resistance)** shall not exceed the values listed in the Ratings Table. Measurement shall be made by the bridge method at a frequency of 100kHz and a temperature of +25°C.
9. **Life Test:** Capacitors shall withstand rated DC voltage applied at + 85°C or two-thirds rated voltage applied at + 125°C for 2000 hours.
- 9.1 Following the life test, the dissipation factor shall meet the initial requirement; the capacitance change shall not exceed ± 10%; the leakage current shall not exceed 125% of the initial requirement.
10. **Vibration Tests:** Capacitors shall be subjected to vibration tests in accordance with the following criteria.
- 10.1 Capacitors shall be secured for test by means of a rigid mounting using suitable brackets.
- 10.2 **Low Frequency Vibration:** Vibration shall consist of simple harmonic motion having an amplitude of 0.03" [0.76mm] and a maximum total excursion of 0.06" [1.52mm], in a direction perpendicular to the major axis of the capacitors.
- 10.2.1 Vibration frequency shall be varied uniformly between the approximate limits of 10 Hz to 55 Hz during a period of approximately one minute, continuously for 1.5 hours.
- 10.2.2 An oscilloscope or other comparable means shall be used in determining electrical intermittency during the final 30 minutes of the test. The AC voltage applied shall not exceed 2 volts rms.
- 10.2.3 Electrical tests shall show no evidence of intermittent contacts, open circuits or short circuits during these tests.
- 10.2.4 Following the low frequency vibration test, capacitors shall meet the original requirements for capacitance, dissipation factor and leakage current.
- 10.3 **High Frequency Vibration:** Vibration shall consist of a simple harmonic motion having an amplitude of 0.06" [1.52] ± 10% maximum total excursion or 20 g peak whichever is less.
- 10.3.1 Vibration frequency shall be varied logarithmically from 50 Hz to 2000 Hz and return to 50 Hz during a cycle period of 20 minutes.
- 10.3.2 The vibration shall be applied for 4 hours in each of 2 directions, parallel and perpendicular to the major axis of the capacitors.
- 10.3.3 Rated DC voltage shall be applied during the vibration cycling.
- 10.3.4 An oscilloscope or other comparable means shall be used in determining electrical intermittency during the last cycle. The AC voltage applied shall not exceed 2 volts rms.
- 10.3.5 Electrical tests shall show no evidence of intermittent contacts, open circuits or short circuits during these tests.
- 10.3.6 There shall be no mechanical damage to these capacitors as a result of these tests.
- 10.3.7 Following the high frequency vibration test, capacitors shall meet the original limits for capacitance, dissipation factor and leakage current.
11. **Acceleration Test:**
- 11.1 Capacitors shall be rigidly mounted by means of suitable brackets.
- 11.2 Capacitors shall be subjected to a constant acceleration of 100 g for a period of 10 seconds in each of 2 mutually perpendicular planes.
- 11.2.1 The direction of motion shall be parallel to and perpendicular to the longitudinal axis of the capacitors.
- 11.3 Rated DC voltage shall be applied during acceleration test.
- 11.3.1 An oscilloscope or other comparable means shall be used in determining electrical intermittency during test. The AC voltage applied shall not exceed 2 volts rms.
- 11.4 Electrical tests shall show no evidence of intermittent contacts, open circuits or short circuits during these tests.
- 11.5 There shall be no mechanical damage to these capacitors as a result of these tests.
- 11.6 Following the acceleration test, capacitors shall meet the original limits for capacitance, dissipation factor and leakage current.



PERFORMANCE CHARACTERISTICS (Continued)

12. Shock Test:

- 12.1** Capacitors shall be rigidly mounted by means of suitable brackets. The test load shall be distributed uniformly on the test platform to minimize the effects of unbalanced loads.
- 12.1.1** Test equipment shall be adjusted to produce a shock of 100 g peak with the duration of 6 mS and sawtooth waveform at a velocity change of 9.7 ft./sec.
- 12.2** Capacitors shall be subjected to 3 shocks applied in each of 3 directions corresponding to the 3 mutually perpendicular axes of the capacitors.
- 12.3** Rated DC voltage shall be applied during test.
- 12.3.1** An oscilloscope or other comparable means shall be used in determining electrical intermittency during tests. The replacement voltage applied shall not exceed 2 volts rms.
- 12.4** Electrical tests shall show no evidence of intermittent contacts, open circuits or short circuits during these tests.
- 12.5** There shall be no mechanical damage to these capacitors as a result of these tests.
- 12.6** Following the shock test, capacitors shall meet the original limits for capacitance, dissipation factor and I leakage current.

13. Moisture Resistance:

- 13.1** Capacitors shall be subjected to temperature cycling at 90% to 95% relative humidity, from + 25°C to +65°C to + 25°C (+ 10°C, - 2°C) over a period of 8 hours per cycle for 1000 hours.
- 13.2** Following the moisture resistance test, the leakage current and dissipation factor shall meet the initial requirements, and the change in capacitance shall not exceed $\pm 10\%$.

14. Thermal Shock:

- 14.1** Capacitors shall be conditioned prior to temperature cycling for 15 minutes at + 25°C, at less than 50% relative humidity and a barometric pressure at 28 to 31"
- 14.2** Capacitors shall be subjected to thermal shock in a cycle of exposure to ambient air at :
- 55°C (+ 0°C, - 5°C) for 30 minutes, then
 - + 25°C (+10°C, - 5°C) for 5 minutes, then

+ 125°C (+ 3°C, - 0°C) for 30 minutes, then
+ 25°C (+ 10°C, - 5°C) for 5 minutes for 5 cycles.

- 14.3** Capacitors shall show no evidence of harmful or extensive corrosion, obliteration of marking or other visible damage.
- 14.4** Following the thermal shock test, capacitors shall meet the original requirements for leakage current and dissipation factor. Capacitance change shall not exceed $\pm 5\%$ of the original measured value.
- 15. Soldering Compatibility:**
- 15.1 Resistance to Solder Heat:** Capacitors will withstand exposure to + 260°C + 5°C for 10 seconds.
- 15.1.1** Following the resistance to soldering heat test, capacitance, dissipation factor and DC leakage current shall meet the initial requirement.
- 15.2 Solderability:** Capacitors will meet the solderability requirements of ANSI/J-STD-002, Test B (MIL-STD-202, method and test S.)
- 16. Terminal Strength:** Per UEC-384-3, minimum of 5N shear force.
- 17. Environmental:** Mercury, CFC and ODS materials are not used in the manufacture of these capacitors.
- 18. Flammability:** Encapsulant materials meet UL94 V0 with an oxygen index of 32%.
- 19. Capacitor Failure Mode:** The predominant failure mode for solid tantalum capacitors is increased leakage current resulting in a shorted circuit. Capacitor failure may result from excess forward or reverse DC voltage, surge current, ripple current, thermal shock or excessive temperature.
- The increase in leakage is caused by a breakdown of the Ta₂O₅ dielectric. For additional information on leakage failure of solid tantalum chip capacitors, refer to Vishay Sprague Technical Paper, "Leakage Failure Mode in Solid Tantalum Chip Capacitors."
- 20. Surge Current:** All D and E case code 293D capacitors are 100% surge current tested at + 25°C and rated voltage. The total series circuit resistance is 0.5 ohms. Each charge cycle of 0.10 seconds is followed by a discharge cycle of 0.10 seconds. Three surge cycles are applied. Each capacitor is tested individually to maximize the peak charging current.

GUIDE TO APPLICATION

1. **A-C Ripple Current:** The maximum allowable ripple current shall be determined from the formula:

$$I_{rms} = \sqrt{\frac{P}{R_{ESR}}}$$

where,

P = Power Dissipation in Watts @ + 25°C as given in the table in Paragraph Number 5 (Power Dissipation).

R_{ESR} = The capacitor Equivalent Series Resistance at the specified frequency.

2. **A-C Ripple Voltage:** The maximum allowable ripple voltage shall be determined from the formula:

$$V_{rms} = Z \sqrt{\frac{P}{R_{ESR}}}$$

or, from the formula:

$$V_{rms} = I_{rms} \times Z$$

where,

P = Power Dissipation in Watts @ + 25°C as given in the table in Paragraph Number 5 (Power Dissipation).

R_{ESR} = The capacitor Equivalent Series Resistance at the specified frequency.

Z = The capacitor impedance at the specified frequency.

- 2.1 The sum of the peak AC voltage plus the DC voltage shall not exceed the DC voltage rating of the capacitor.
- 2.2 The sum of the negative peak AC voltage plus the applied DC voltage shall not allow a voltage reversal exceeding 10% of the DC rating at + 25°C.
3. **Reverse Voltage:** These capacitors are capable of withstanding peak voltages in the reverse direction equal to 10% of the DC rating at + 25°C, 5% of the DC rating at + 85°C and 1% of the DC rating at +125°C.
4. **Temperature Derating:** If these capacitors are to be operated at temperatures above + 25°C, the permissible rms ripple current or voltage shall be calculated using the derating factors as shown:

Temperature	Derating Factor
+ 25°C	1.0
+ 85°C	0.9
+ 125°C	0.4

5. **Power Dissipation:** Power dissipation will be affected by the heat sinking capability of the mounting surface. Non-sinusoidal ripple current may produce heating effects which differ from those shown. It is

important that the equivalent *I_{rms}* value be established when calculating permissible operating levels. (Power Dissipation calculated using + 25°C temperature rise.)

Case Code	Maximum Permissible Power Dissipation @ + 25°C (Watts) in free air
A	0.075
B	0.085
C	0.110
D	0.150
E	0.165
P	0.025

6. **Printed Circuit Board Materials:** Type 293D capacitors are compatible with commonly used printed circuit board materials (alumina substrates, FR4, FR5, G10, PTFE-fluorocarbon and porcelainized steel).
7. **Attachment:**
- 7.1 **Solder Paste:** The recommended thickness of the solder paste after application is .007" ± .001" [.178mm ± .025mm]. Care should be exercised in selecting the solder paste. The metal purity should be as high as practical. The flux (in the paste) must be active enough to remove the oxides formed on the metallization prior to the exposure to soldering heat. In practice this can be aided by extending the solder preheat time at temperatures below the liquidous state of the solder.
- 7.2 **Soldering:** Capacitors can be attached by conventional soldering techniques - vapor phase, infrared reflow, wave soldering and hot plate methods. The Soldering Profile chart shows maximum recommended time/temperature conditions for soldering. Attachment with a soldering iron is not recommended due to the difficulty of controlling temperature and time at temperature.
8. **Cleaning (Flux Removal) After Soldering:** The 293D is compatible with all commonly used solvents such as TES, TMS, Prelete, Chloroethane, Terpene and aqueous cleaning media. However, CFC/ODS products are not used in the production of these devices and are not recommended. Solvents containing methylene chloride or other epoxy solvents should be avoided since these will attack the epoxy encapsulation material.
- 8.1 When using ultrasonic cleaning, the board may resonate if the output power is too high. This vibration can cause cracking or a decrease in the adherence of the termination. DO NOT EXCEED 9W/l @ 40kHz for 2 minutes.

GUIDE TO APPLICATION (Continued)

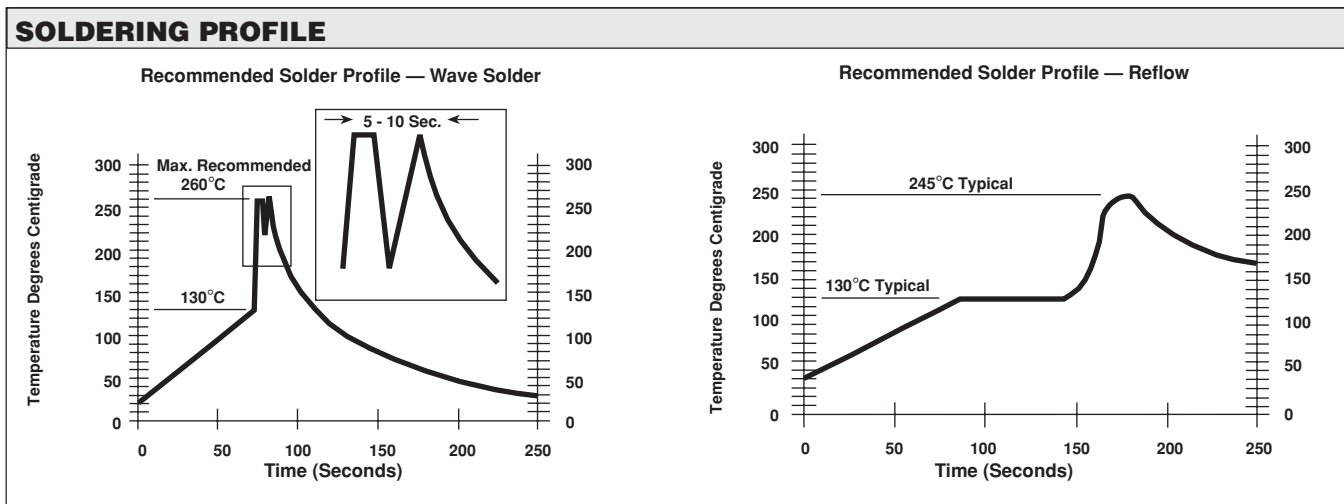

9. **Recommended Mounting Pad Geometries:** Proper mounting pad geometries are essential for successful solder connections. These dimensions are highly process sensitive and should be designed to minimize component rework due to unacceptable solder joints. The dimensional configurations shown are the recommended pad geometries for both wave and reflow soldering techniques. These dimensions are intended to be a starting point for circuit board designers and may be fine tuned if necessary based upon the peculiarities of the soldering process and/or circuit board design.

RECOMMENDED MOUNTING PAD GEOMETRIES in inches [millimeters]

Wave Solder Pads

Reflow Solder Pads

Pad Dimensions						Pad Dimensions					
Case Code	A (Min.)	B (Nom.)	C (Nom.)	D (Nom.)	E (Nom.)	Case Code	A (Min.)	B (Nom.)	C (Nom.)	D (Nom.)	E (Nom.)
A	0.034 [0.87]	0.085 [2.15]	0.053 [1.35]	0.222 [5.65]	0.048 [1.23]	A	0.071 [1.80]	0.085 [2.15]	0.053 [1.35]	0.222 [5.65]	0.048 [1.23]
B	0.061 [1.54]	0.085 [2.15]	0.065 [1.65]	0.234 [5.95]	0.048 [1.23]	B	0.110 [2.80]	0.085 [2.15]	0.065 [1.65]	0.234 [5.95]	0.048 [1.23]
C	0.061 [1.54]	0.106 [2.70]	0.124 [3.15]	0.337 [8.55]	0.050 [1.28]	C	0.110 [2.80]	0.106 [2.70]	0.124 [3.15]	0.337 [8.55]	0.050 [1.28]
D	0.066 [1.68]	0.106 [2.70]	0.175 [4.45]	0.388 [9.85]	0.050 [1.28]	D	0.118 [3.00]	0.106 [2.70]	0.175 [4.45]	0.388 [9.85]	0.050 [1.28]
E	0.066 [1.68]	0.106 [2.70]	0.175 [4.45]	0.388 [9.85]	0.050 [1.28]	E	0.118 [3.00]	0.106 [2.70]	0.175 [4.45]	0.388 [9.85]	0.050 [1.28]
P	0.034 [0.87]	0.085 [2.15]	0.053 [1.35]	0.222 [5.65]	0.048 [1.23]	P	0.071 [1.80]	0.085 [2.15]	0.053 [1.35]	0.222 [5.65]	0.048 [1.23]

TAPE AND REEL PACKAGING in inches [millimeters]

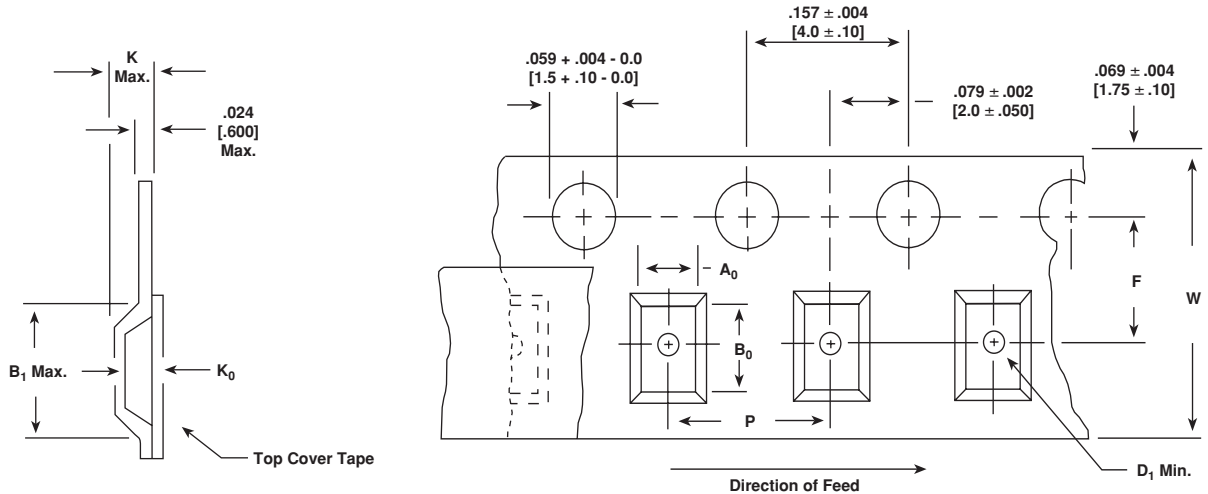

TAPE SIZE	B ₁ (Max.)	D ₁ (Min.)	F	K (Max.)	P	W	A ₀ B ₀ K ₀
8mm	0.165 [4.2]	0.039 [1.0]	0.138 ± 0.002 [3.5 ± 0.05]	0.094 [2.4]	0.157 ± 0.004 [4.0 ± 1.0]	0.315 ± 0.012 [8.0 ± 0.30]	Notes: A ₀ B ₀ K ₀ are determined by component size. The clearance between the component and the cavity must be within 0.002" [0.05mm] minimum to 0.020" [0.50mm] maximum for 8mm tape and 0.002" [0.05mm] minimum to 0.026" [0.65mm] maximum for 12mm tape.
12mm	0.323 [8.2]	0.059 [1.5]	0.217 ± 0.002 [5.5 ± 0.05]	0.177 [4.5]	0.315 ± 0.004 [8.0 ± 1.0]	0.472 ± 0.012 [12.0 ± 0.30]	

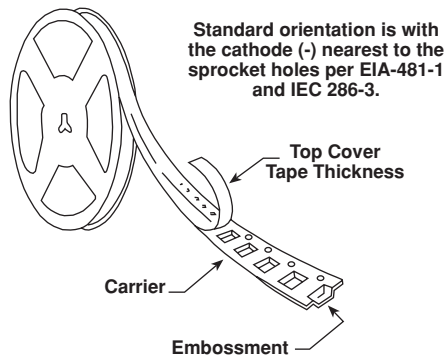

Tape and Reel Specifications: All case codes are available on plastic embossed tape per EIA-481-1. Tape reeling per IEC 286-3 is also available. Standard reel diameter is 13" [330mm]. 7" [178mm] reels are available.

The most efficient packaging quantities are full reel increments on a given reel diameter. The quantities shown allow for the sealed empty pockets required to be in conformance with EIA-481-1. Reel size must be specified in the Vishay Sprague part number.

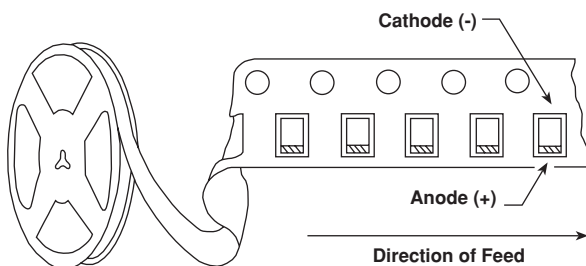

Case Code	Tape Width	Component Pitch	Units Per Reel	
			7" [178mm] Reel	13" [330mm] Reel
A	8mm	4mm	2000	9000
B	8mm	4mm	2000	8000
C	12mm	8mm	500	3000
D	12mm	8mm	500	2500
E	12mm	8mm	400	1500
P	8mm	4mm	3000	10000