

DUAL OPERATIONAL AMPLIFIER

■ GENERAL DESCRIPTION

The NJM14558 is dual operational amplifier, which can operate from $\pm 2V$ supply. The features are low offset voltage, low bias current and low current consumption.

The package lineup is DIP, DMP and others, so that the NJM14558 is suitable for portable audio and any kind of signal amplifier.

■ FEATURES

- Operating Voltage ($\pm 2.0V \sim \pm 7.0V$)
- Input Offset Voltage (3mV max.)
- Slew Rate (2.5V/ μs typ.)
- Bipolar Technology
- Package Outline DIP8, DMP8, EMP8, SSOP8, VSP8, SIP8

■ PACKAGE OUTLINE

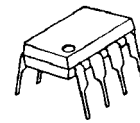

NJM14558D



NJM14558M



NJM14558E



NJM14558V



NJM14558R

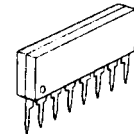

NJM14558L

■ PIN CONFIGURATION

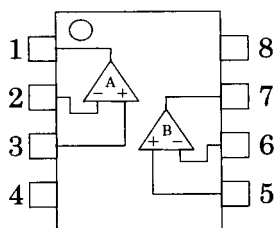

NJM14558/14558M/14558E
NJM14558V/14558R

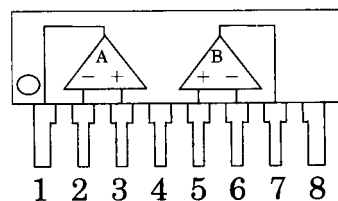

NJM14558L

PIN FUNCTION

1. A OUTPUT
2. A -INPUT
3. A +INPUT
4. V⁻
5. B +INPUT
6. B -INPUT
7. B OUTPUT
8. V⁺

■ EQUIVALENT CIRCUIT (1/2 Shown)

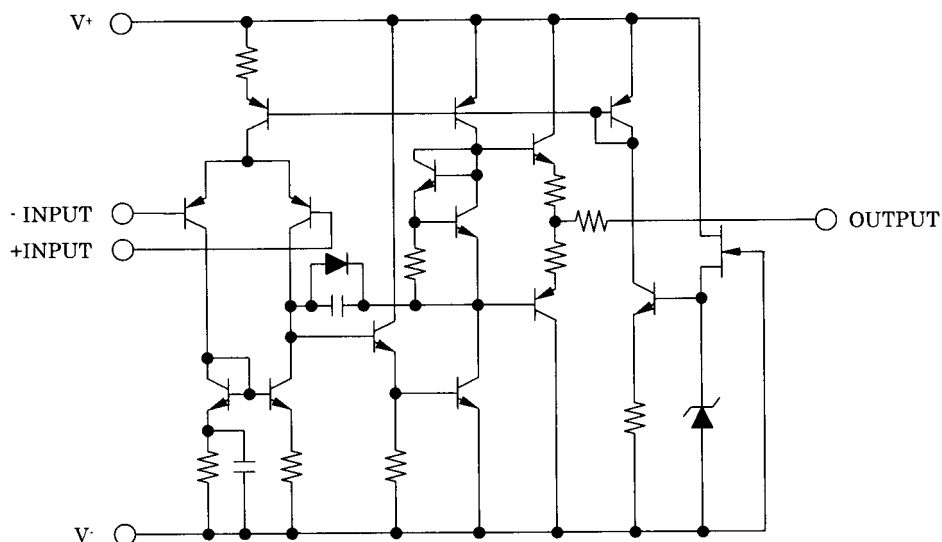

NJM14558

www.DataSheet4U.com

■ ABSOLUTE MAXIMUM RATINGS

(Ta=25°C)

PARAMETER	SYMBOL	RATINGS	UNIT
Supply Voltage	V^+ / V^-	± 7.5	V
Differential Input Voltage	V_{ID}	± 14	V
Input Voltage	V_{IC}	± 7 (note)	V
Power Dissipation	P_D	(DIP8) 500 (DMP8) 300 (EMP8) 300 (SSOP8) 250 (VSP8) 320 (SIP8) 800	mW
Operating Temperature Range	T_{opr}	-40~+85	°C
Storage Temperature Range	T_{stg}	-40~+125	°C

(note) For supply voltage less than $\pm 7V$, the absolute maximum input voltage is equal to the supply voltage.

■ ELECTRICAL CHARACTERISTICS

($V^+ / V^- = \pm 5V, Ta = 25^\circ C$)

PARAMETER	SYMBOL	TEST CONDITION	MIN.	TYP.	MAX.	UNIT
Operating Voltage	V_{opr}		± 2	-	± 7	V
Input Offset Voltage	V_{IO}	$R_S \leq 10k\Omega$	-	0.5	3	mV
Input Offset Current	I_{IO}		-	5	50	nA
Input Bias Current	I_B		-	70	250	nA
Input Resistance	R_{IN}		0.3	5	-	MΩ
Large Signal Voltage Gain	A_V	$R_L \geq 2k\Omega, V_O = \pm 3V$	86	100	-	dB
Maximum Output Voltage Swing (+)	V_{OM}^+	$R_L \geq 2k\Omega$	3.5	4.0	-	V
Maximum Output Voltage Swing (-)	V_{OM}^-	$R_L \geq 2k\Omega$	-	-3.5	-3.0	V
Input Common Mode Voltage Range	V_{ICM}		± 3.0	± 4.0	-	V
Common Mode Rejection Ratio	CMR	$R_S \leq 10k\Omega$	70	90	-	dB
Supply Voltage Rejection Ratio	SVR	$R_S \leq 10k\Omega$	76.5	90	-	dB
Operating Current	I_{CC}		-	2.7	4.5	mA
Slew Rate	SR		-	2.5	-	V/ μs
Equivalent Input Noise Voltage	V_{Ni}	RIAA, $R_S = 2.2k\Omega, 30kHz$:LPF	-	1.4	-	μV_{rms}
Gain Bandwidth Product	GB		-	5	-	MHz

■ TYPICAL CHARACTERISTICS

NJM14558 Operating Current vs. Operating Voltage

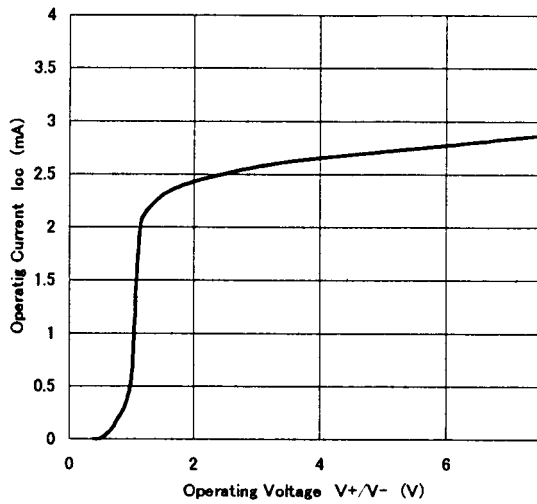

NJM14558 Input Offset Voltage vs. Operating Voltage

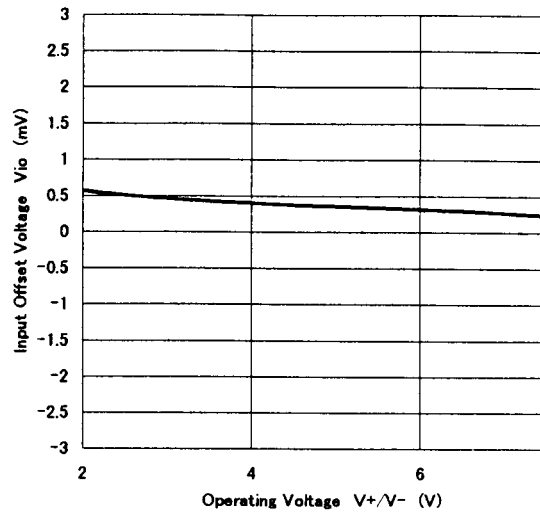

NJM14558 Input Bias Current vs. Operating Voltage

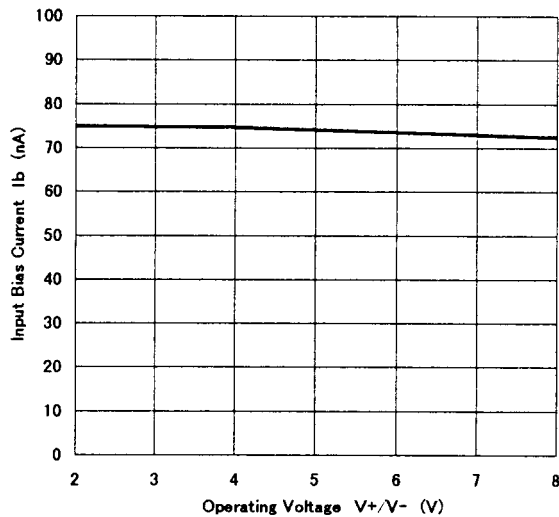

NJM14558 Maximum Output Voltage Swing vs. Operating Voltage

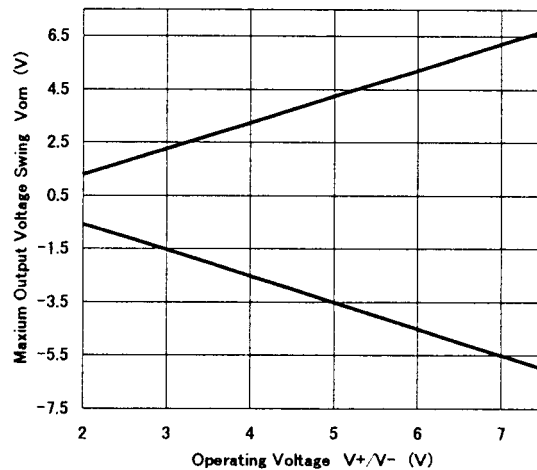

NJM14558 Input Common Mode Voltage Range

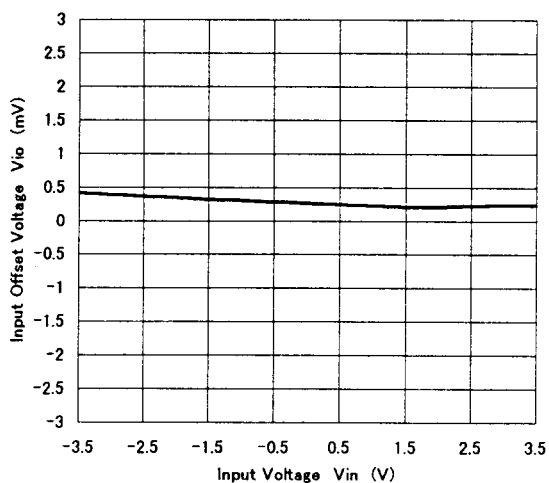

NJM14558

www.DataSheet4U.com

■ TYPICAL CHARACTERISTICS

NJM14558 Maximum Output Voltage Swing vs. Load Resistance

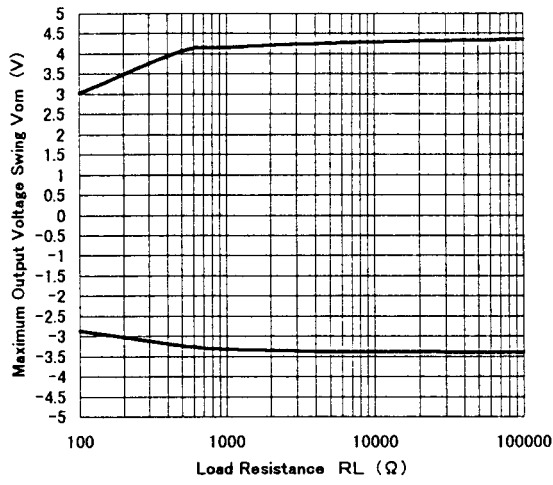

NJM14558 Maximum Output Voltage Swing vs. Frequency

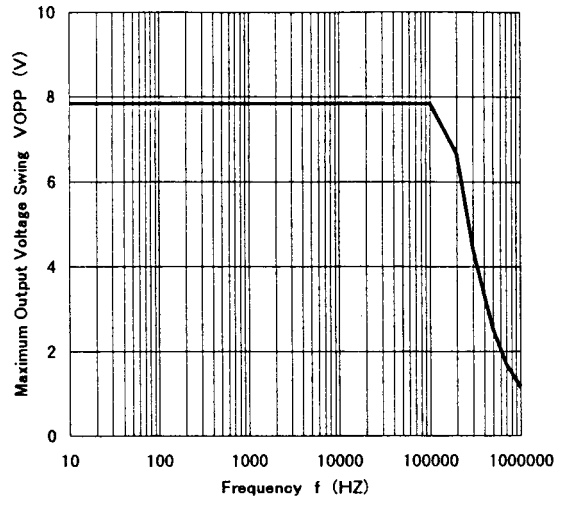

■ TYPICAL CHARACTERISTICS

NJM14558 Large Signal Voltage Gain vs. Operating Voltage

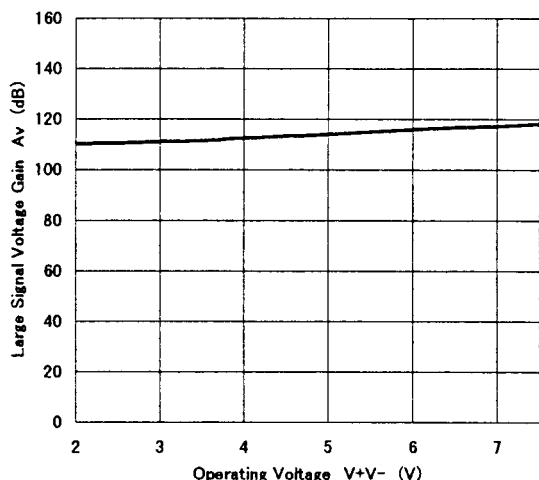

NJM14558 Large Signal Voltage Gain vs. Frequency

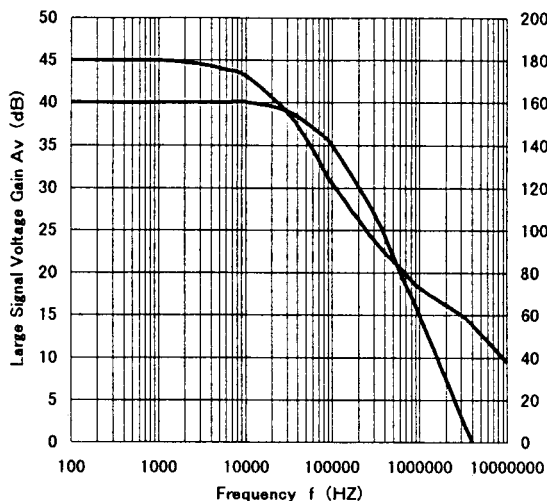

NJM14558 Slew Rate(Fall)

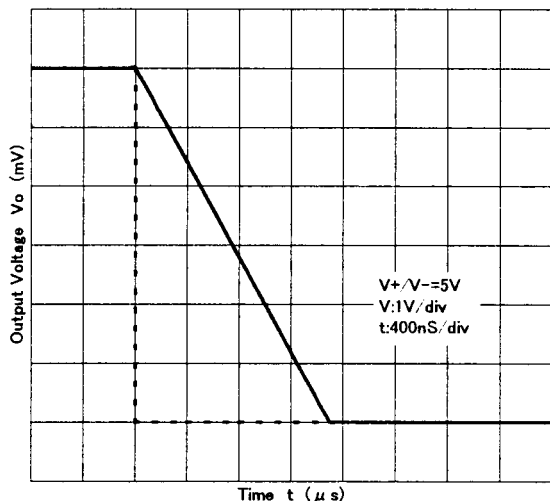

NJM14558 Slew Rate(Rise)

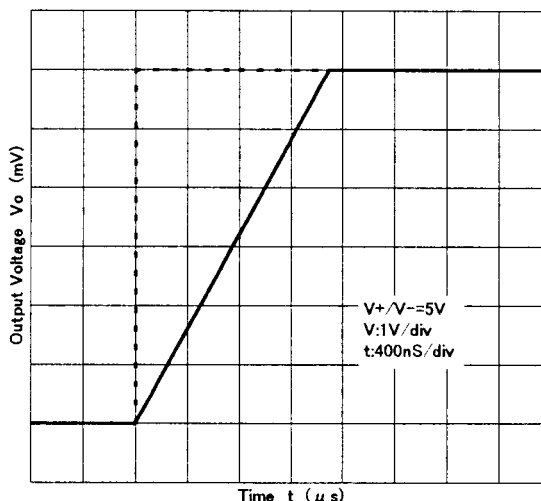

NJM14558 THD vs. Output Voltage

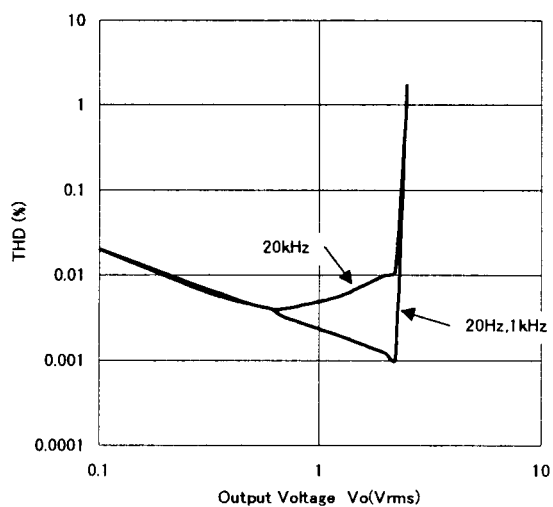

NJM14558 Equivalent Input Noise Voltage vs. Frequency

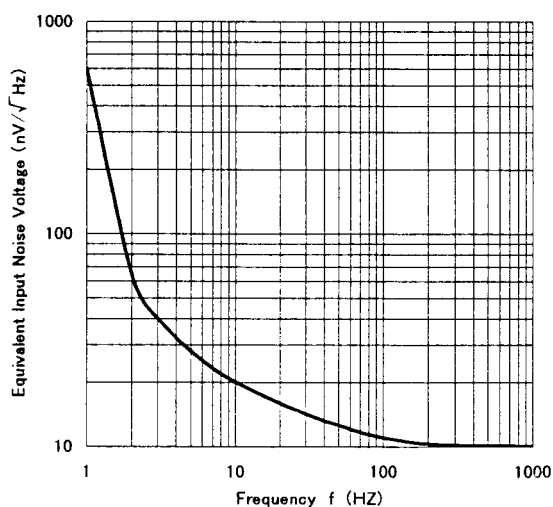

■ TYPICAL CHARACTERISTICS

NJM14558 Operating Current vs. Temperature

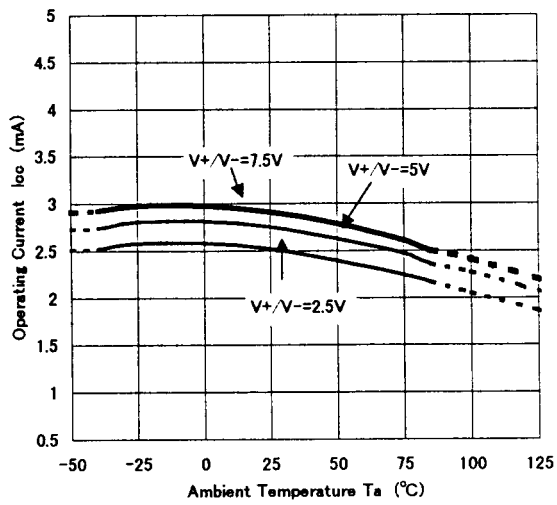

NJM14558 Input Offset Voltage vs. Temperature

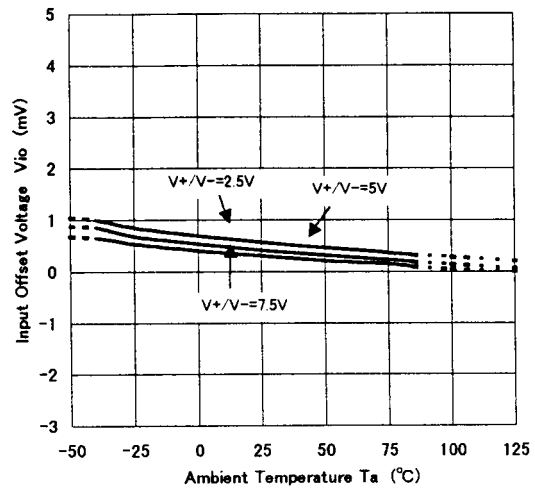

NJM14558 Input Bias Current vs. Temperature

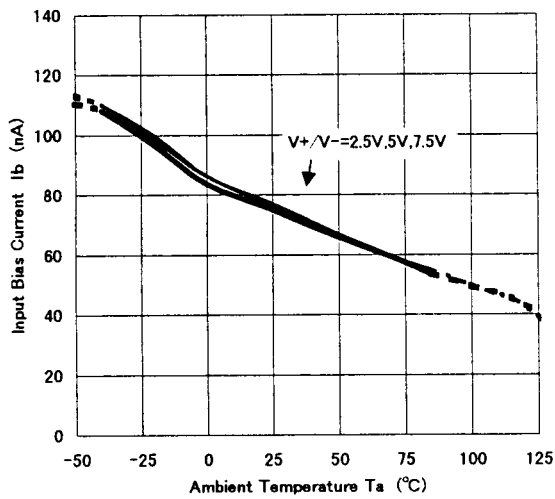

NJM14558 Maximum Output Voltage Swing vs. Temperature

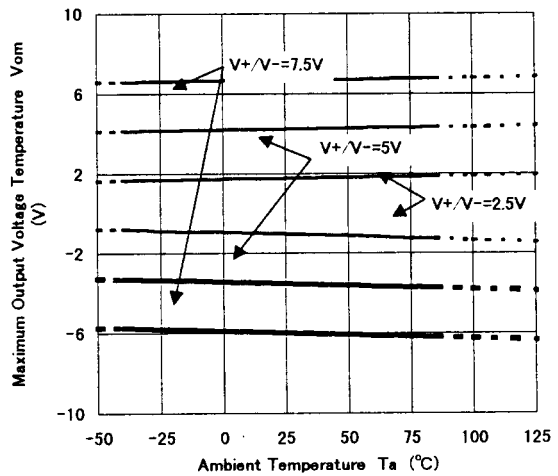

■ TYPICAL CHARACTERISTICS

NJM14558 Large Signal Voltage Gain vs. Temperature

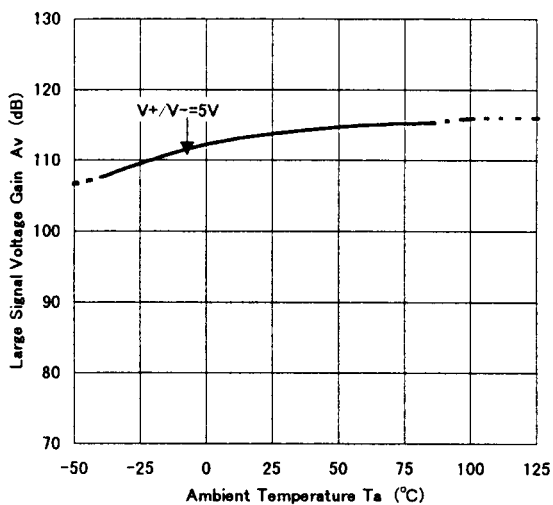

NJM14558 Common Mode Rejection Ratio vs. Temperature

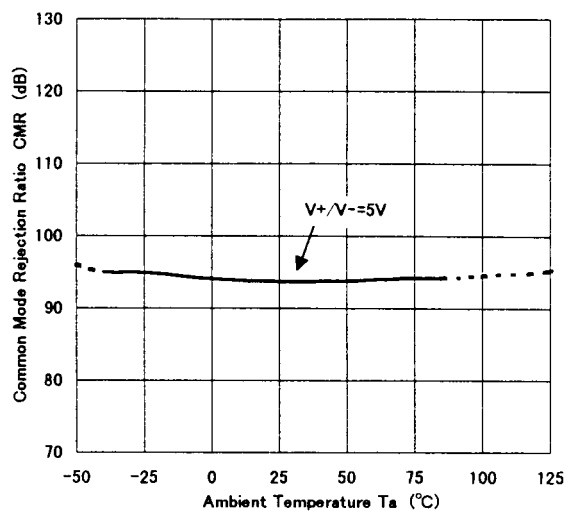

NJM14558 Supply Voltage Rejection Ratio vs. Temperature

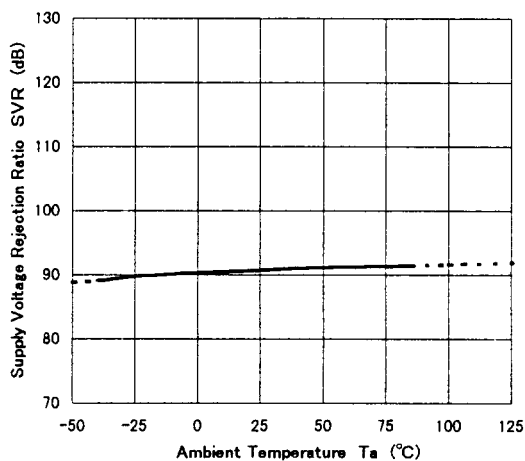

[CAUTION]

The specifications on this databook are only given for information, without any guarantee as regards either mistakes or omissions. The application circuits in this databook are described only to show representative usages of the product and not intended for the guarantee or permission of any right including the industrial rights.