

Silicon Schottky Diodes

- For low-loss, fast-recovery, meter protection, bias isolation and clamping applications
- Integrated diffused guard ring
- Low forward voltage

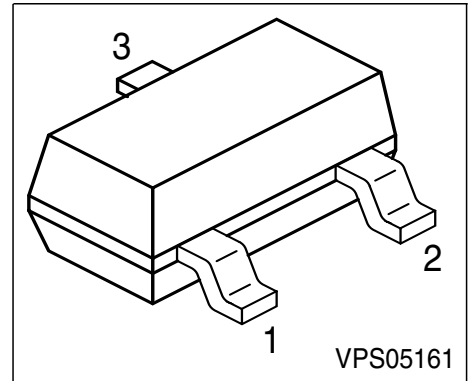

BAS 125

BAS 125-04

BAS 125-05

BAS 125-06

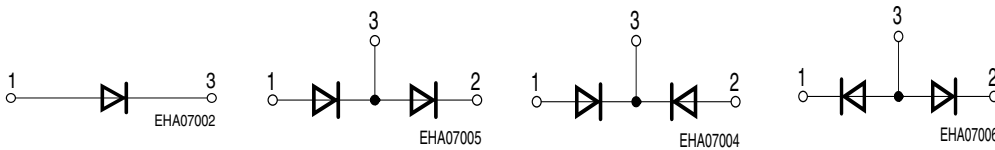

ESD: Electrostatic discharge sensitive device, observe handling precaution!

Type	Marking	Pin Configuration			Package
BAS 125	13s	1 = A	2 = n.c.	3 = C	SOT-23
BAS 125-04	14s	1 = A1	2 = C2	3 = C1/A2	SOT-23
BAS 125-05	15s	1 = A1	2 = A2	3 = C1/2	SOT-23
BAS 125-06	16s	1 = C1	2 = C2	3 = A1/2	SOT-23

Maximum Ratings

Parameter	Symbol	Value	Unit
Diode reverse voltage	V_R	25	V
Forward current	I_F	100	mA
Surge forward current ($t < 100\mu s$)	I_{FSM}	500	
Total power dissipation	P_{tot}		mW
$T_S = 59\text{ }^\circ\text{C}$ BAS 125		250	
$T_S = 34\text{ }^\circ\text{C}$ BAS 125-04 -05 -06		250	
Junction temperature	T_j	150	$^\circ\text{C}$
Storage temperature	T_{stg}	-55 ... 150	

Thermal Resistance

Parameter	Symbol	Value	Unit
Junction - ambient ¹⁾ BAS 125	R_{thJA}	≤ 445	K/W
Junction - ambient ¹⁾ BAS 125-04 -05 -06	R_{thJA}	≤ 625	
Junction - soldering point BAS 125	R_{thJS}	≤ 365	
Junction - soldering point BAS 125-04 -05 -06	R_{thJS}	≤ 465	

Electrical Characteristics at $T_A = 25^\circ\text{C}$, unless otherwise specified

Parameter	Symbol	Values			Unit
		min.	typ.	max.	

DC Characteristics

Reverse current $V_R = 20\text{ V}$ $V_R = 25$	I_R	-	-	100 150	nA
Forward voltage $I_F = 1\text{ mA}$ $I_F = 10\text{ mA}$ $I_F = 35\text{ mA}$	V_F	-	385 530 800	400 650 950	mV

AC Characteristics

Diode capacitance $V_R = 0\text{ V}$, $f = 1\text{ MHz}$	C_T	-	-	1.1	pF
Differential forward resistance $I_F = 5\text{ mA}$, $f = 10\text{ kHz}$	R_F	-	15	-	Ω
Forward voltage matching ²⁾ $I_F = 10\text{ mA}$	ΔV_F	-	-	20	mV

1) Package mounted on alumina 15mm x 16.7mm x 0.7mm

2) ΔV_F is the difference between the lowest and the highest V_F in the component

Forward current $I_F = f(V_F)$

T_A = Parameter

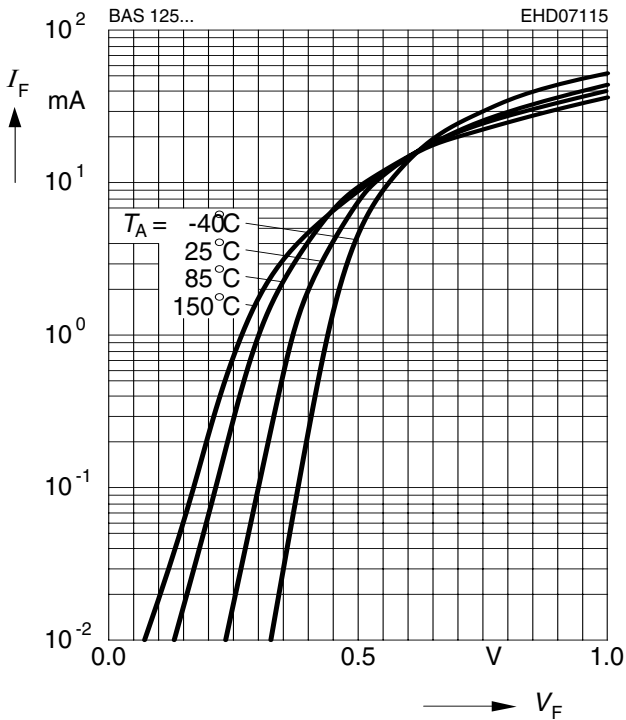

Forward current $I_F = f(T_A^*, T_S)$

*Package mounted on alumina

BAS 125-04, -05, -06

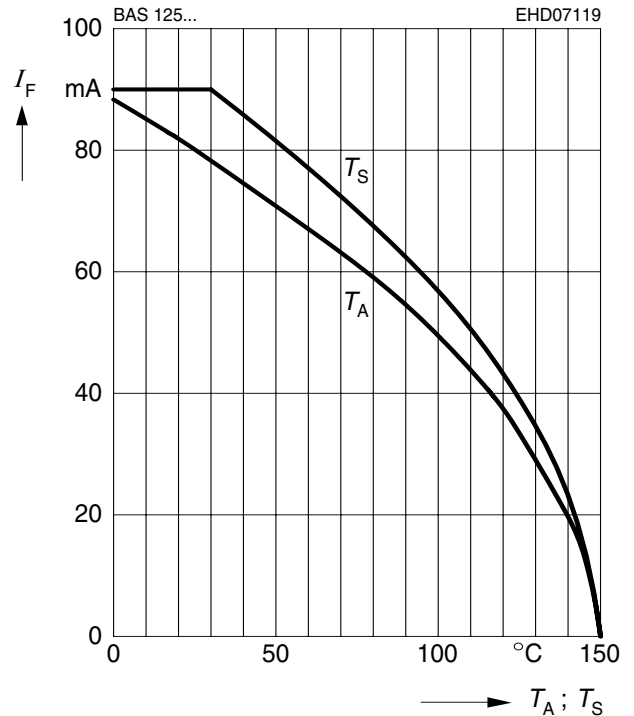

Forward current $I_F = f(T_A^*, T_S)$

*Package mounted on alumina

BAS 125

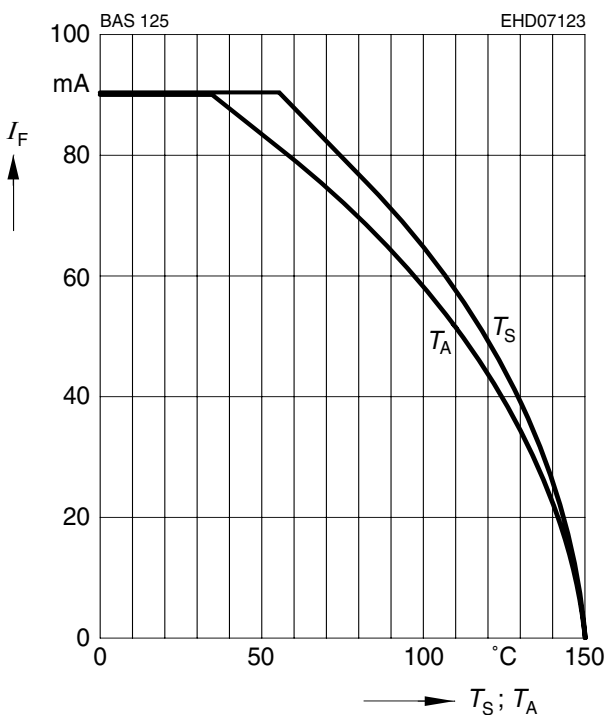

Reverse current $I_R = f(V_R)$

T_A = Parameter

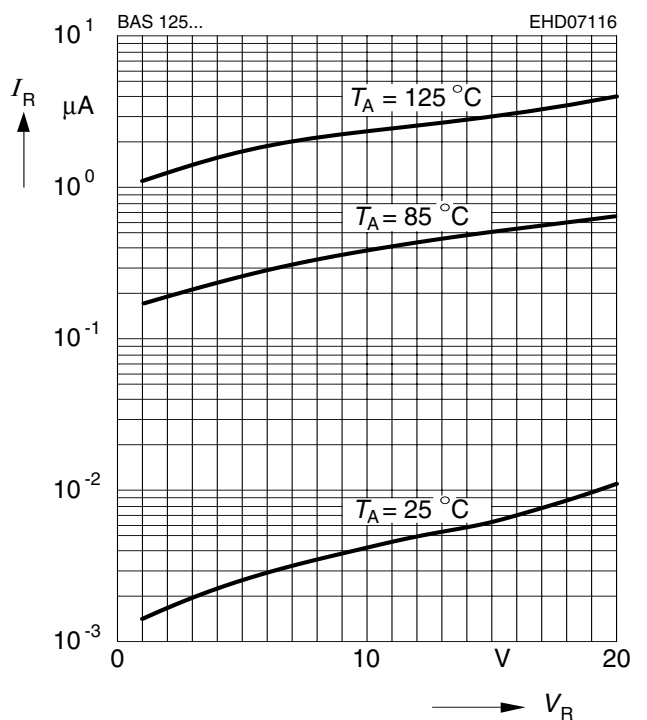

Diode capacitance $C_T = f(V_R)$

$f = 1\text{MHz}$

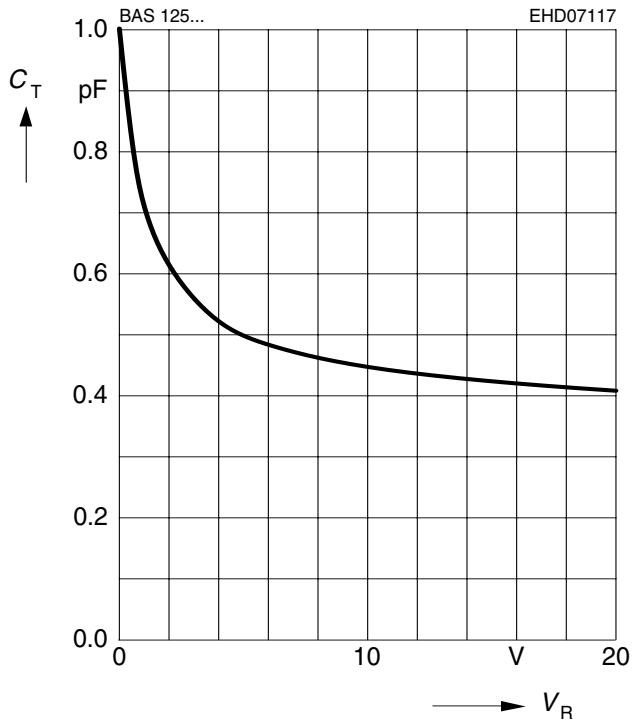

Differential forward resistance $r_f = f(I_F)$

$f = 10\text{kHz}$

