

VTR RF Modulator

www.DataSheet4U.com

Description

CXA1122AP is a VTR RF modulator for the VHF band, and is used to convert frequencies of audio signals and video signals.

This modulator consists of circuits such as video clamp, white clipping, a carrier oscillator, video modulator, audio FM modulator, frequency/channel switch, and antenna switch driver.

Features

- Operates with low voltage and low consumption power. ($V_{cc} = 5\text{ V}$, $I_{cc} = 17.5\text{ mA}$, $I_{cont} = 20\text{ to }25\text{ mA}$)
- Low radiation and harmonic products.
- Provided with few external devices.
- Permits two channels in the VHF band.
- Provided with a built-in regulator and is resistant to power source changes.
- Allows video input of 0.5 V_{p-p} and various uses.
- Supports a one-mixer system to simplify the RF unit design.
- Permits the signal ratio of video to audio to be adjusted with an external capacitor.
- Provided with a carrier-off SW function for boss audio.
- Has a built-in antenna switch driver.
- Has a wide oscillation margin for a SAW (Surface Acoustic Wave) resonator.

Package Outline

Unit: mm

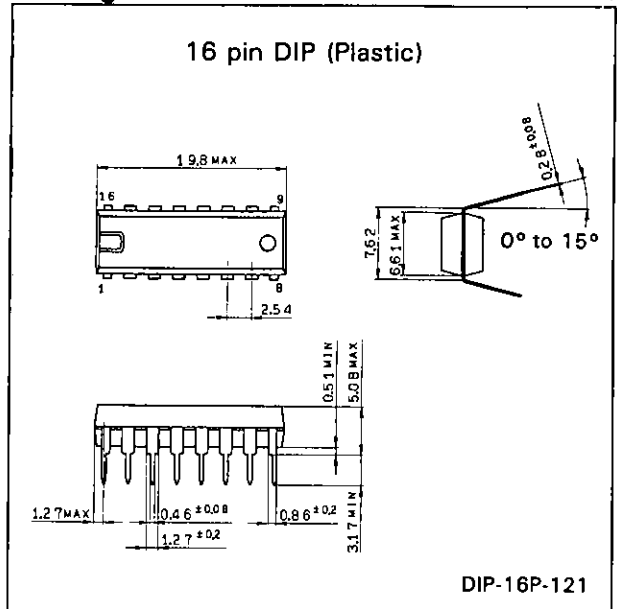

Absolute Maximum Ratings ($T_a = 25^\circ\text{C}$)

- Supply voltage V_{cc} 12 V
- Operating temperature T_{opr} $-20\text{ to }+75^\circ\text{C}$
- Storage temperature T_{stg} $-55\text{ to }+150^\circ\text{C}$
- Allowable power P_D 550 mW dissipation

Recommended Operating Condition

- Supply voltage V_{cc} 4.4 to 9.3 V

Structure

Bipolar silicon monolithic IC

Block Diagram

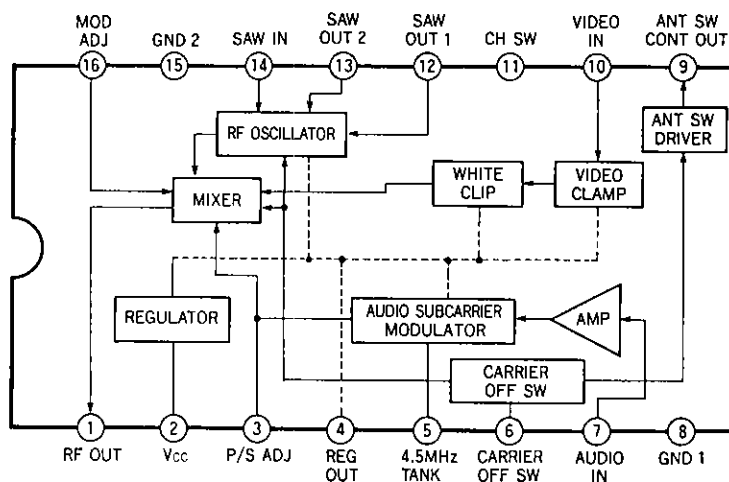

Pin Description and Equivalent Circuits

www.DataSheet4U.com

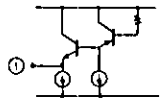
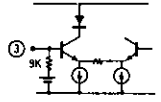
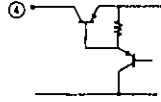
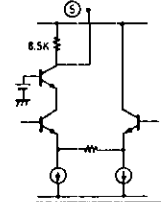
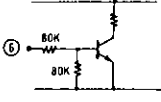
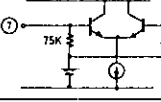
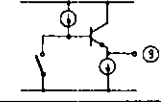
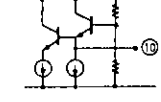
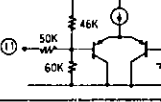
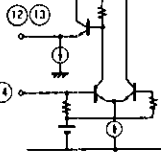
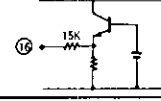
No.	Symbol	Voltage typical value (V)	Equivalent circuit	Description	
1	RF OUT	2.9		RF output pin (modulates video and audio FM signals into AM signals and outputs them.)	
2	Vcc			Vcc supply voltage pin	
3	P/S ADJ	1.8		P/S adjustment pin (The signal ratio of video to audio gets larger as capacitance is added between pin 3 and GND.)	
4	REG OUT	3.95		Regulator output pin.	
5	4.5 MHz TANK	3.05		Audio tank coil connecting pin	
6	CARRIER OFF SW	0		Carrier off switch (OPEN → carrier OFF, Vcc → carrier ON) The RF output can be switched to ON or OFF with the high-impedance input switch.	
7	AUDIO IN	1.95		Audio input pin	
8	GND1				
9	ANT SW DRIVER	4.0		Links up with pin 6 switch to supply the DC voltage output to the antenna switch circuit.	ON
		0		OFF	
10	VIDEO IN	2.6		Video input pin	
11	CH SW	2.3		Channel switch OPEN ↔ GND LOW 0 to 0.7V High 2.3 to Vcc	
12	SAW OUT1	4.4, 3.7		Output 1 SAW resonator	
13	SAW OUT2	3.7, 4.4		Output 2 SAW resonator	
14	SAW IN	2.5		Input SAW resonator	
15	GND2				
16	MOD ADJ	0.80		Pin for slightly adjusting the modulation depth.	

Electrical Characteristics 1

(See the Electrical Characteristics Test Circuit)
 Ta = 25°C, Vcc = 5 V

Item	Symbol	Test condition	Min.	Typ.	Max.	Unit	
Supply current 1	Icc1	Pin 6 = High	14	17.5	22	mA	
Supply current 2	Icc2	Pin 6 = Low	7.5	9.5	12	mA	
ANT SW CONT	Icont	Pin 6 = High, Icont = 25 mA load	3.7	4.0	4.3	V	
Video output level	Vo(fp1)	V1 = No input	85.5	88.0	90.5	dBμ	
	Vo(fp2)	Vo1 output level * 1					
Video output level temperature stability	ΔVo(fp1)	Vo(fp1) (Ta = -10 to +70°C) – Vo(fp1) (Ta = 25°C) –	–	–	± 2	dB	
	ΔVo(fp2)	Vo(fp2) (Ta = -10 to +70°C) – Vo(fp1) (Ta = 25°C)					
Video modulation depth	mp1	V1 = 0.5 Vp-p WHITE	72	78	84	%	
	mp2	Vo modulation depth					
Video modulation depth temperature stability	Δmp1	mp1 (Ta = -10 to +70°C) – mp1 (Ta = 25°C)	–	–	± 2.5	%	
	Δmp2	mp2 (Ta = -10 to +70°C) – mp2 (Ta = 25°C)					
Video modulation depth difference between channels	Δmp	mp1 – mp2	–	± 0.2	± 2	%	
Maximum video modulation depth	Δmp2 (Max.)	V1 = 1.0Vp-p, WHITE Vo modulation depth * 2 Δmp2 = mp2 – mp2 (max)	11.5	15.0	18.5	%	
920 kHz beat	Vb	V1 = 0.5 Vp-p sin 3.58-MHz input * 3	64	70	–	dB	
Sync-crush level	ΔSync	V1 = 0.5Vp-p, WHITE Vo output $1 - \{(V \text{ Sync}/V \text{ White}) \times \frac{100}{40}\}$	–	–	10	%	
Differential gain	DG1	V1 = 0.5Vp-p, STAIR STEP	–	1	3	%	
	DG2	Vo DG * 4					
Differential phase	DP1	V1 = 0.5Vp-p, STAIR STEP	–	2	5	deg	
	DP2	Vo DP * 4					
Video higher-harmonic wave ratio	VvH	V1 = 0.5Vp-p, 1 MHz CW * 5	–	–56	–46	dB	
RF carrier ratio of video to audio	Vps	V1 = no Video Signal, C1 = 3pF	S1 = 2	11.5	13.5	15.5	dB
			S1 = 1				
Audio FM Central frequency temperature stability	Δfs	S1 = 1, Fs = Vo2 frequency fs(Ta = 0 to 60°C) – fs(Ta = 25°C) * 6	–	–	± 10	kHz	
Audio FM modulation sensitivity *	βS	S1 = 1, C2 = 39pF V2 = pin 7 DC voltage ± 0.2 V fs frequency change/0.4 V * 7	0.445	0.555	0.665	kHz/mV	
Audio total harmonic distortion ratio	THD	S1 = 1, V2 = 1 kHz * 8	–	0.30	0.8	%	
Audio S/N	ASN	The audio S/N is 0 dB at 60% modulation	55	59	–	dB	
Maximum audio FM modulation depth	ms(Max.)	S1 = 1, V2 = pin 7 DC voltage ± 1.0V FS frequency change/50 kHz × 100	400	–	–	%	

* Classifications

www.DataSheet4U.com

Marking	Audio FM modulation sensitivity (kHz/mV)
A1122AP-3	0.665 to 0.577
A1122AP-1	0.595 to 0.515
A1122AP-2	0.533 to 0.445

Electrical Characteristics 2 (Design security items: This parameter is not 100% tested.)

1. Video S/N	Min. 50 dB Typ. 58 dB
2. Video amplitude frequency characteristic (based on 1 MHz)	Within ± 1 dB for 0.5 to 5 MHz
3. Audio amplitude frequency characteristic (based on 1 kHz)	Within ± 1 dB for 0.1 to 60 kHz

- Note)**
- *1. Measure the V_o output level using the spectrum analyzer with a 50Ω input impedance and convert measured value V_o into decibels (dBm) using the following expression:
Output (dB μ) = V_o (dBm) + 113
 - *2. The difference in image modulation depth between the maximum modulation depth at an input of 0.5 Vp-p and at an input of 1.0 Vp-p.
 - *3. Directly-read value (dB) of the component ratio of the 920 kHz beat to the video carrier level measured with a spectrum analyzer
 - *4. Measured with the standard-type demodulator after demodulation.
 - *5. $f_c + 2$ MHz or $f_c + 3$ MHz level to the V_o carrier (f_c) level
 - *6. Adjust f_s to 4.500 MHz with $T_a = 25^\circ\text{C}$.
 - *7. A 15 k Ω resistor is added in series for pre-emphasis so that a better match can be obtained between audio modulation sensitivity classifications.
 - *8. Adjust the V_2 level so that the FM deviation is ± 15 kHz and measure the total harmonic distortion after demodulating V_o with the standard-type demodulator.

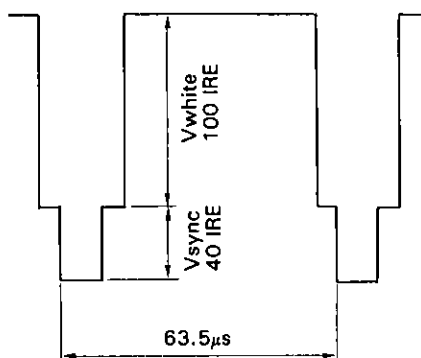
Input Waveforms**WHITE signal****STAIR STEP signal**

APL 50% subcarrier 20 IRE

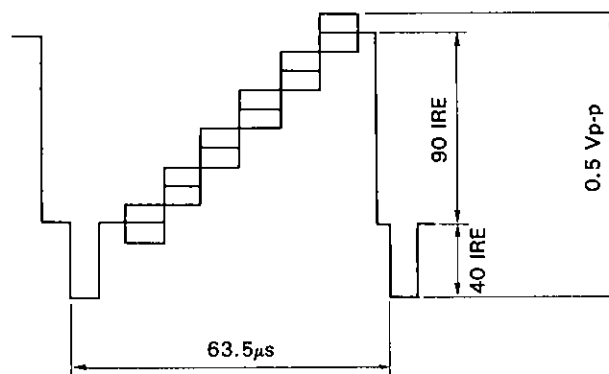

Electrical Characteristics Test Circuit

www.DataSheet4U.com

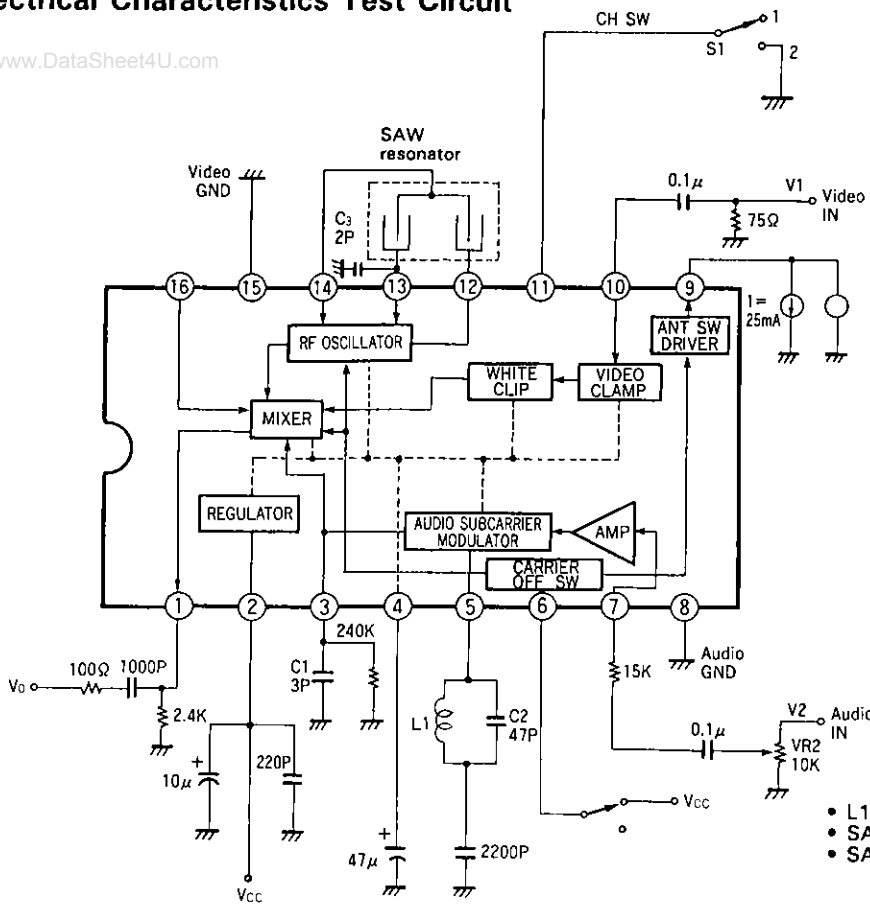

- L1 5SVNR-3039FE (Toko)
- SAW resonator KAR-91CS (Kyo-sela)
- SAW resonator TQS-101A-6R (TOYO-COM)

Application Circuit

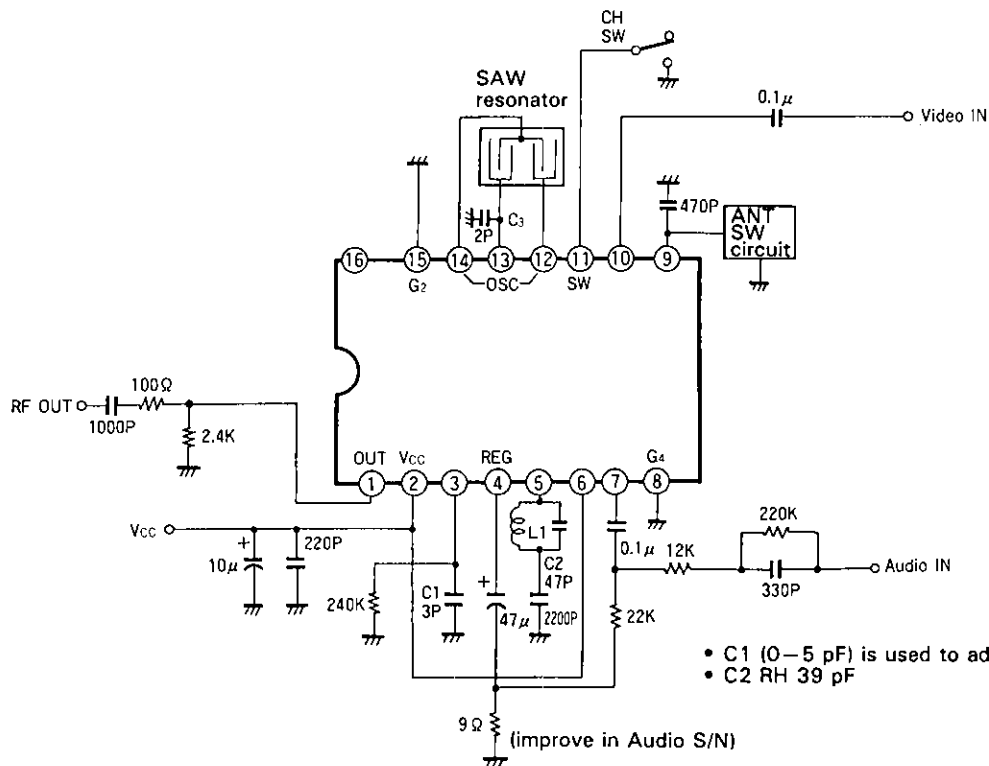

- C1 (0-5 pF) is used to adjust the video to audio ratio.
- C2 RH 39 pF

Circuit current vs. Supply voltage

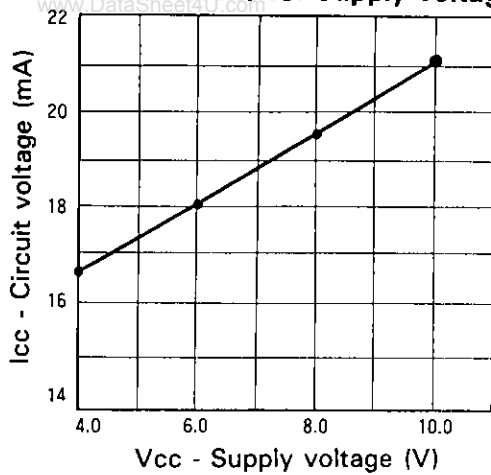

Video output level vs. Supply voltage

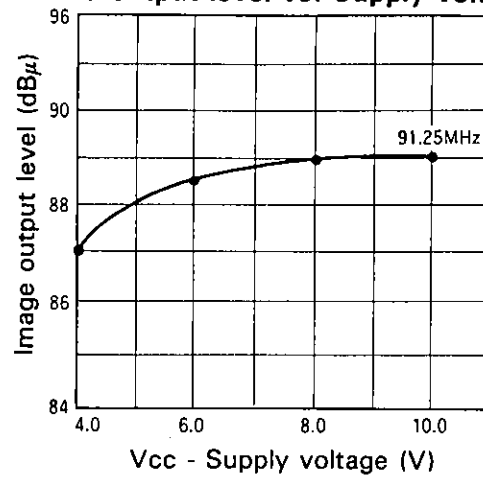

Video modulation depth vs. Supply voltage

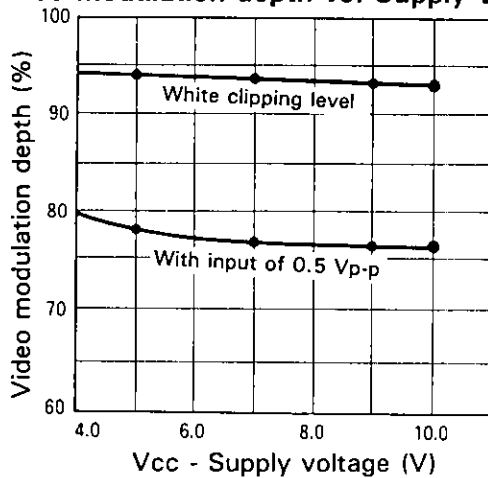

Video to audio ratio vs. Supply voltage

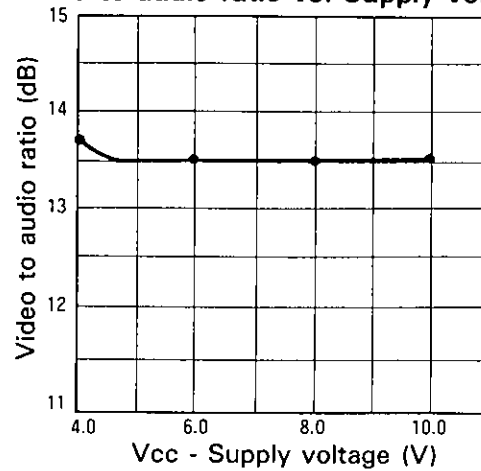

Differential phase vs. Supply voltage

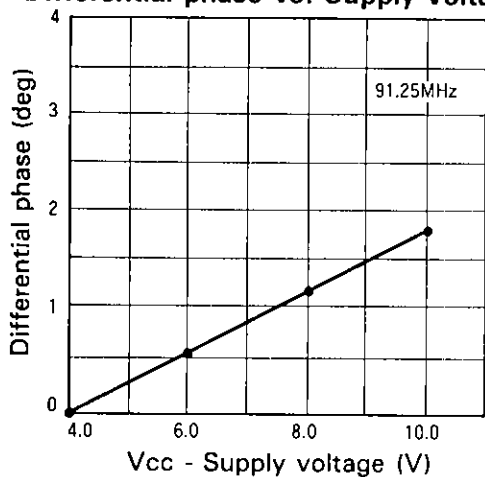

Differential gain vs. Supply voltage

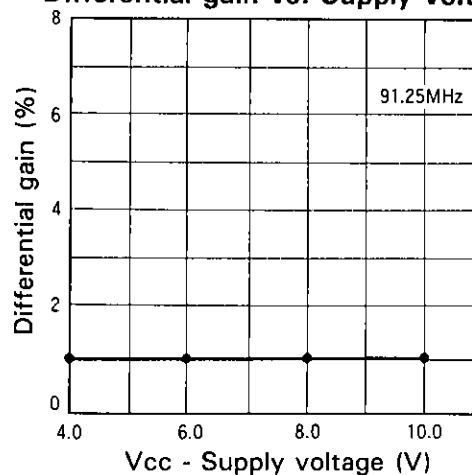

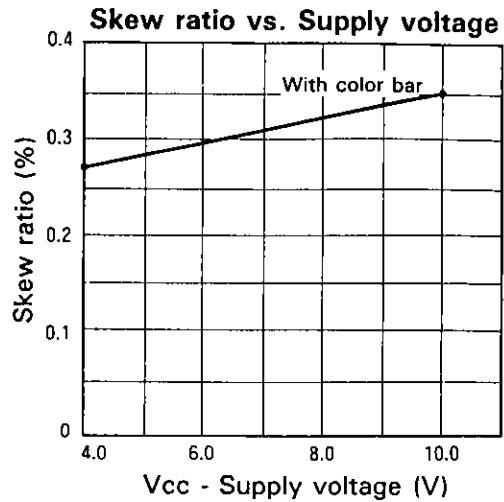
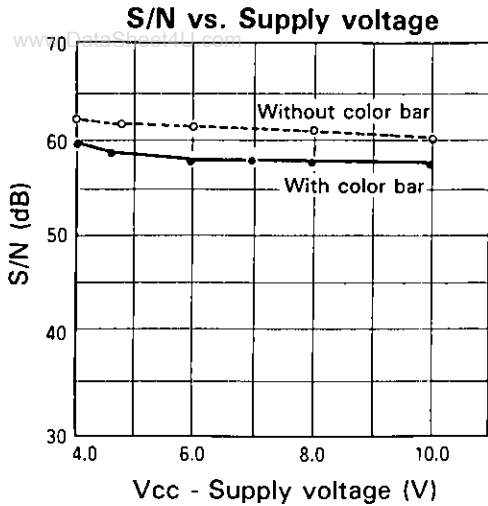

ANT SW driver load vs. Voltage characteristic

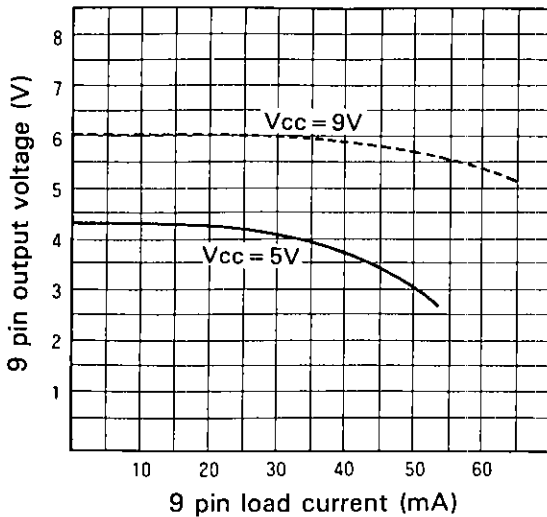

920 kHz beat vs. Supply voltage

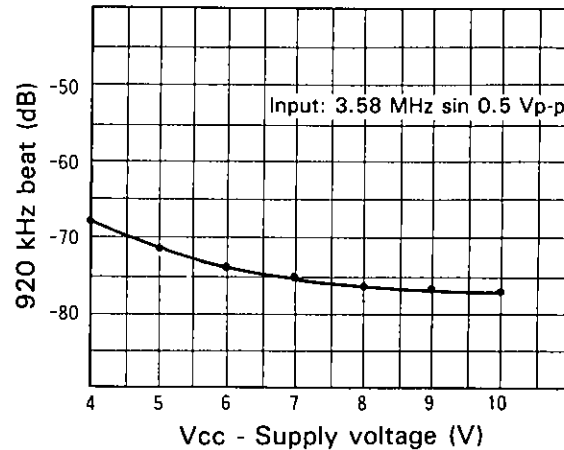

Inter-carrier change vs. Supply voltage

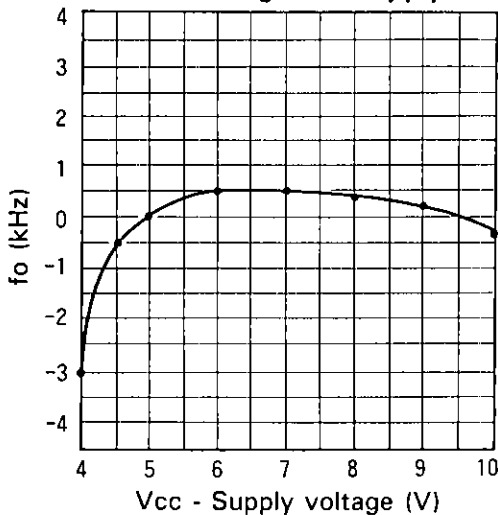

Supply ripple characteristics { Techtronics AA501 DISTORTION ANALYZER Rms measurement

