

## SOFT START-UP VALVE SERIES AV 2000, 3000, 4000 1/4, 3/8, 1/2"

- ✓ Combined soft start and quick exhaust valve
- ✓ Compatible with modular series FRL
- ✓ Large Cv factor
- ✓ Low power
- ✓ Air supply and exhaust can be operated manually
- ✓ High relief capacity



### TECHNICAL SPECIFICATIONS

Model	AV2000	AV3000	AV4000		
Port size	1/4	3/8	1/2		
Proof pressure	1.5 MPa				
Operating pressure range	1.0 MPa				
Pressure gauge port size	3/8				
Ambient and fluid temperature	0 ~ 60°C*				
Frequency of operation	3 ~ 5 cycles/day (See Note 1)				
CV factor	P→A	1.19	2.20	3.60	
	A→R	1.39	2.89	4.49	
Weight (kg)	0.27	0.48	0.74		
Electrical Spec.	Coil rated voltage	110, 240V AC (50/60Hz); 12, 24V DC			
	Allowable voltage fluctuation	-15% to +10% of rated voltage			
	Coil insulation type	Type B equivalent (130°C)			
	Apparent power AC (power consumption)	Inrush	5.6VA (50Hz)		
		Holding	3.4VA (2.1W)/50Hz		
	Power consumption DC	1.8W			
	Electrical connector	DIN 43650 (industrial form)			
Semi-standard spec.	With indicator light and surge voltage suppressor				
Pilot valve manual override	Non-locking push type				

\*Use dry air when temperature is low.

NOTE 1: NOT FOR FREQUENT USE SUCH AS MACHINE GUARDS.

The AV valve pictured together with an AW series Filter/Regulator and an AN series Silencer. (To order these items see Air Preparation section {AW} and Valves section {AN})

### SYMBOLS

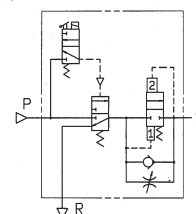

### HOW TO ORDER SOFT START-UP VALVE

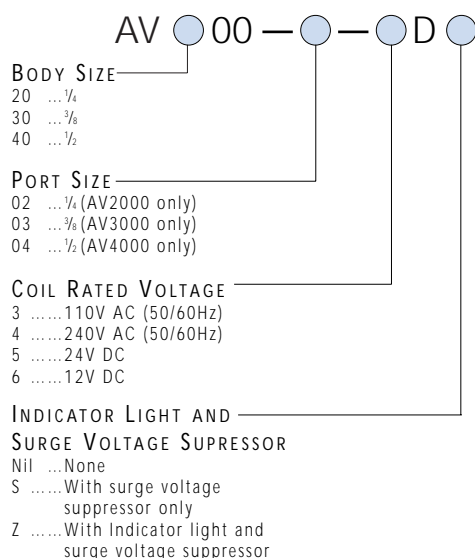

### CAUTION

Safety Note

1. This valve cannot prevent cylinders shooting out when a closed-centre solenoid valve is used, or equipment driving with a load factor of 50% or more.
2. When a regulator is to be mounted on the secondary side, use a check valve regulator (AR\*\*60). Standard regulators (AR2000, 3000, 4000) do not allow large volume back-flow.
3. Mount a lubricator, as necessary, on the primary side (P port side) of the valve. When the lubricator is mounted on the secondary side (A port side), oil back-flows and is exhausted from port R.
4. The AV Series is not designed or certificated as a Safety product within the definitions of BS EN954-1 Category 1,2,3 or 4 system, secondary monitoring or protection must be in place.

**STOCKED PRODUCTS**  
FOR A LIST OF STOCKED PRODUCTS,  
PLEASE SEE THE CURRENT SMC PRICE LIST

DIMENSIONS  
SEE NEXT PAGE



FOR FURTHER TECHNICAL  
DETAILS ON THIS  
PRODUCT REQUEST  
CATALOGUE REFERENCE  
E5G

## MODULAR TYPE – ACCESSORIES

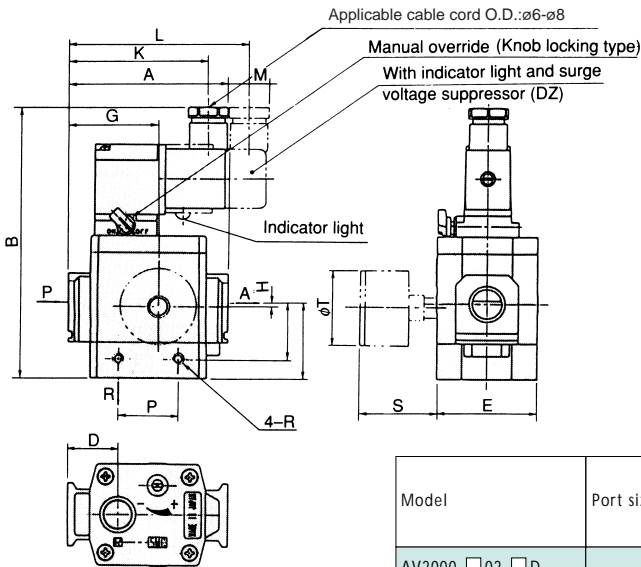
 DIMENSIONS  
DIN CONNECTOR

Model	Port size	A	B	C	D	E	Pressure gauge Mounting port	G	H	I	J	K	L	M	N	P	Q	R
							F											
AV2000-□02-□D	1/4	66	125.5	31	22	40	1/8	38	0	—	—	67.5	—	10.5	—	29	23.5	M4X0.7 depth 4.5
AV2000-□02-□DZ												—	84.5	27.5				
AV3000-□03-□D	3/8	76	132.5	36	24	48	1/8	43	2	—	—	70.5	—	3.5	—	28	27.5	M5X0.8 depth 5
AV3000-□03-□DZ												—	87.5	20.5				
AV4000-□04-□D	1/2	98	147.5	47	32	52	1/8	57	3	—	—	82.5	—	—	—	42	37	M6X1 depth 6
AV4000-□04-□DZ												—	99.5	10.5				

## DIMENSIONS

## EXAMPLE OF AC3000 + SOFT START-UP VALVE

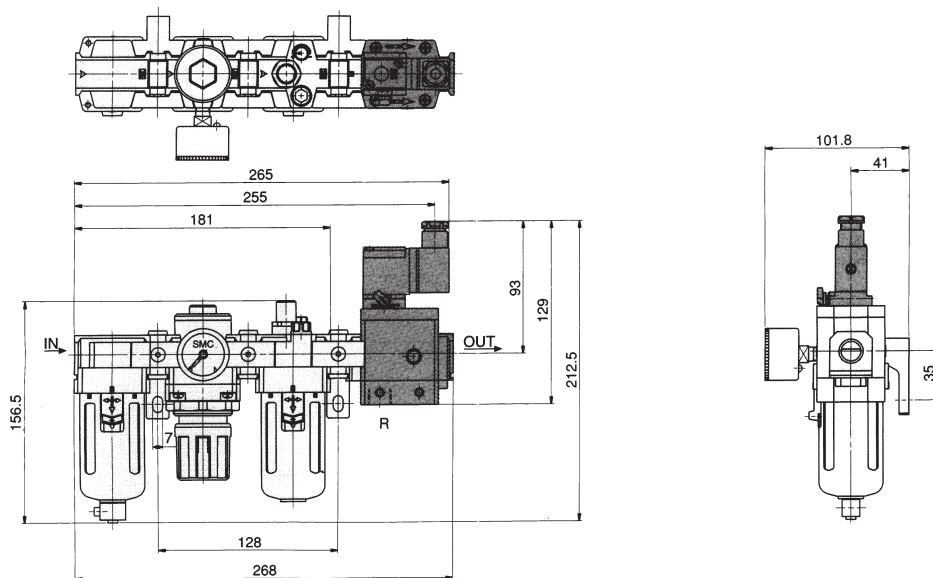
 SEE INSIDE FRONT COVER FOR  
DETAILS OF YOUR LOCAL SALES OFFICE

 FOR FURTHER TECHNICAL  
DETAILS ON THIS  
PRODUCT REQUEST  
CATALOGUE REFERENCE  
E5G

## PRESSURE SWITCH: SERIES IS1000

- ✓ Reed switch type design
- ✓ Compact
- ✓ Pressure setting made easy by scale plate
- ✓ Type M sandwiches between air preparation units: Type E acts as an end connector

### NOTE

The pressure switch type-M can be mounted on both IN and OUT sides on AF, AR, AFM, and AFD units but cannot be mounted in this way on AW or AV units, in this case use type-E as an end connector.



Type - M



Type - E

The switches shown below DO NOT come with Yoke Clips attached. (See How to Order)

### TECHNICAL SPECIFICATIONS

Fluid	Air
Proof pressure	1.0 MPa
Max. operating pressure	0.7 MPa
Setting range (off)	0.1 - 0.4 MPa
Differential pressure (Hysteresis)	Less than 0.08 MPa
Ambient & fluid temperature	5 - 60°C
Type of actuation	1a (N.O.)
Switch capacity	AC2VA • DC2W
Operating voltage (AC, DC)	12V, 24V, 48V, 100V
Max. operating current	AC, DC 12V - 48V: 50mA AC, DC 100V: 25mA
Response time	1.2ms

### DIMENSIONS PRESSURE SWITCH IS1000M

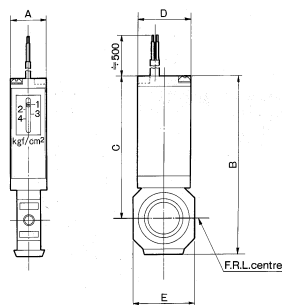

Model*	A	B	C	D	E
IS1000M-2	15	73.5	62.6	23	28
IS1000M-3	15	82	64.9	23	29
IS1000M-4	15	88.7	67.6	23	35
IS1000M-5	15	91	71	23	44
IS1000M-6	15	100	72.5	23	54

\*Without Yoke Clip.

### DIMENSIONS PRESSURE SWITCH IS1000E

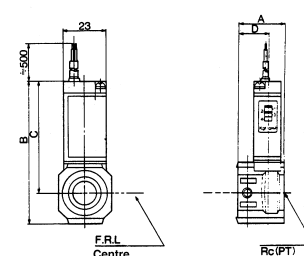

Model*	Port	A	B	C	D	Combination Series
IS1000E-201	1/8"					AC2000
IS1000E-202	1/4"	28	73	62	18.5	
IS1000E-203	3/8"					
IS1000E-302	1/4"					AC3000
IS1000E-303	3/8"	26	80	63	16.5	
IS1000E-304	1/2"	40	80	63	17.5	AC4000
IS1000E-402	1/4"					
IS1000E-403	3/8"	33	87	66	17.5	
IS1000E-404	1/2"					
IS1000E-406	3/4"	50	87	66	17.5	

\*Without Yoke Clip.

### HOW TO ORDER PRESSURE SWITCH MODULAR TYPE

Intermediate connector type-M, complete with yoke clips and 3m lead

- IS1000M-2Y-X201      2000 SERIES
  - IS1000M-3Y-X201      3000 SERIES
  - IS1000M-4Y-X201      4000 SERIES
  - IS1000M-6Y-X201      5/6000 SERIES
- (Option: -X215 for setting range 0.15-0.5MPa)

End unit type-E, on Y20 to Y40 end spacer, complete with yoke clips and 3m lead.

- IS1000E-201Y-X201 ... 2000 SERIES 1/8" PORT
  - IS1000E-202Y-X201 ... 2000 SERIES 1/4" PORT
  - IS1000E-302Y-X201 ... 3000 SERIES 1/4" PORT
  - IS1000E-303Y-X201 ... 3000 SERIES 3/8" PORT
  - IS1000E-402Y-X201 ... 4000 SERIES 1/4" PORT
  - IS1000E-403Y-X201 ... 4000 SERIES 3/8" PORT
  - IS1000E-404Y-X201 ... 4000 SERIES 1/2" PORT
- (Option: -X215 for setting range 0.15-0.5MPa)

For non-modular IS1000, see 'Compact pressure switch IS1000 (Single contact)' in the instrumentation section.

### STOCKED PRODUCTS FOR A LIST OF STOCKED PRODUCTS, PLEASE SEE THE CURRENT SMC PRICE LIST



### SYMBOLS



THE IS1000E SHOWN TOGETHER WITH A  
FILTER/REGULATOR SERIES AW



FOR FURTHER TECHNICAL  
DETAILS ON THIS  
PRODUCT REQUEST  
CATALOGUE REFERENCE  
E5G

## MODULAR TYPE – ACCESSORIES

 SHUT OFF VALVE  
 SERIES VHS (3 PORT RELIEVING)

- ✓ Relieves the downstream pressure for system servicing.
- ✓ Visual position indication

SMC Pneumatics' Series VHS 3 Port Valves provide a means to prevent accidental start-ups while personnel are cleaning or servicing equipment. When in the exhaust position, the valve may be padlock secured.

To eliminate any uncertainty of valve status, a window displays when the valve is in supply or exhaust position.

\* Simple user modification allows lock in pressure supply position.

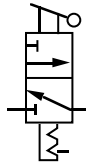
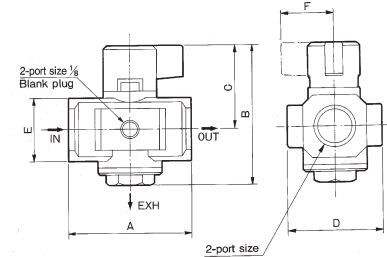
 DIMENSIONS  
 SERIES VHS SHUT-OFF VALVE

Model	Port Size	Exh. Port	A	B	C	D	E	F
VHS2000	1/8, 1/4	1/8	40	56	36	28	22	25
VHS3000	1/4, 3/8	1/4	53	74	45	48	28	30
VHS4000	1/4, 3/8, 1/2	3/8	70	80	48	54	36	30

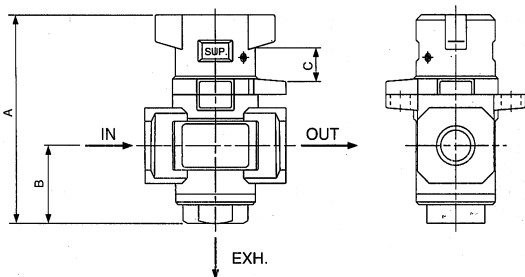
 DIMENSIONS  
 SERIES VHS 3 PORT VALVE  
 WITH LOCKING FACILITY

Model	Port Size	Exh Port	A	B	C	D	E	ØF	G	ØH
VHS2500	1/8, 1/4	1/8	60	20	12.8	40	44	33	28	7.5
VHS3500	1/4, 3/8	1/4	73	29	12.8	53	53	42	29	7.7
VHS4500	1/4, 3/8, 1/2	3/8	85	32	12.6	70	64	49	36	10
VHS5500	3/4, 1	1/2	136	56	32	90	80	65	54	10

 HOW TO  
 ORDER  
 SERIES VHS SHUT-OFF VALVES

VHS 00 00 00 00 00

 BODY SIZE AND  
 APPLICABLE FRL SERIES

- 2 .....2000
- 3 .....2500, 3000
- 4 .....4000
- 5 .....5000

## LOCKING OPTION

- 0 .....Standard
- 5 .....Lockable

## INPUT PORT SIZE

- 01 ...Rc 1/8
- 02 ...Rc 1/4
- 03 ...Rc 3/8
- 04 ...Rc 1/2
- 06 ...Rc 3/4
- 10 ...Rc 1

## HANDLE COLOUR

- Nil ...Black handle and grey body
- X1 ...Red handle and body

**STOCKED PRODUCTS**  
 FOR A LIST OF STOCKED PRODUCTS,  
 PLEASE SEE THE CURRENT SMC PRICE LIST



SEE INSIDE FRONT COVER FOR  
 DETAILS OF YOUR LOCAL SALES OFFICE



FOR FURTHER TECHNICAL  
 DETAILS ON THIS  
 PRODUCT REQUEST  
 CATALOGUE REFERENCE  
 E5G

## CHECK VALVE SERIES AKM

The check valve spacer is designed to prevent back flow of lubricated air from a lubricator when both lubricated and non-lubricated supplies are required.



**DIMENSIONS**

CHECK VALVE SERIES AKM

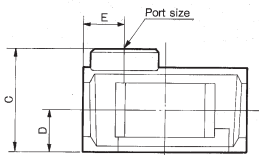
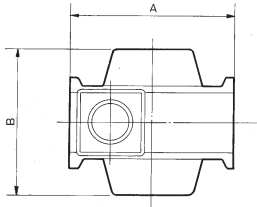

Model	Port Size	A	B	C	D	E
AKM2000	1/8 1/4	40	40	28	11	11
AKM3000	1/8 1/4	53	48	34	14	13
AKM4000	1/8 3/8	70	54	42	18	15

**HOW TO  
 ORDER**

CHECK VALVE SERIES AKM



<b>BODY SIZE</b>		<b>PORT SIZE</b>
2000.....2000 Series	01	... 1/8
3000.....3000 Series	02	... 1/4
4000.....4000 Series	03	... 3/8

**SYMBOLS**

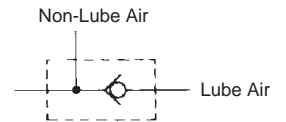

**STOCKED PRODUCTS**

FOR A LIST OF STOCKED PRODUCTS,  
 PLEASE SEE THE CURRENT SMC PRICE LIST



# MODULAR TYPE – ACCESSORIES

## MEMBRANE AIR DRYER SERIES IDG

- ✓ Outlet air flow range 50, 100, 200, 300 and 500 l/min at -20°C outlet dewpoint
- ✓ No external power source required
- ✓ Environmentally friendly non-freon
- ✓ Lightweight and compact. Easy to handle
- ✓ No vibration or exhaust heat
- ✓ Dew point indicator for easy inspection of air drying condition
- ✓ Three atmospheric dew point options -15°C (H), -20°C (std), and -40°C (L - demanded by semi-conductor industry)
- ✓ Optional one touch fitting to exhaust purge air
- ✓ Modular assembly available with integral prefilters (AFM/AFD)

**NOTE: This product will be released during 1998. Please contact your SMC Regional Centre for the latest information.**



### TECHNICAL SPECIFICATIONS

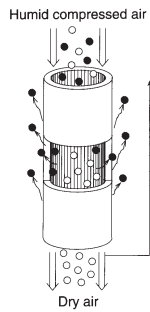
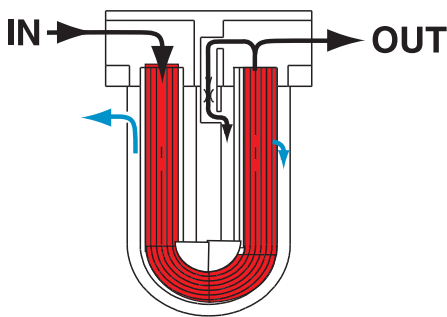

The Membrane Air Dryer uses hollow fibre made of a high molecular membrane which has the characteristics of passing water vapour easily, but not to pass air/gas.

- Air/gas
- Water vapour

When humid air is supplied to the inside of the hollow fibre tube and dry air reduced to near atmospheric pressure is supplied to the outside of the hollow fibre tube as purge air, water vapour penetrates from the inside of the membrane to the outside due to the pressure differential between the water vapour inside the tube and the purge air outside. With this principle, the compressed air which passes through the hollow fibre tube is dehumidified.

SYMBOL

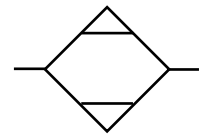

### HOW TO ORDER SINGLE UNIT

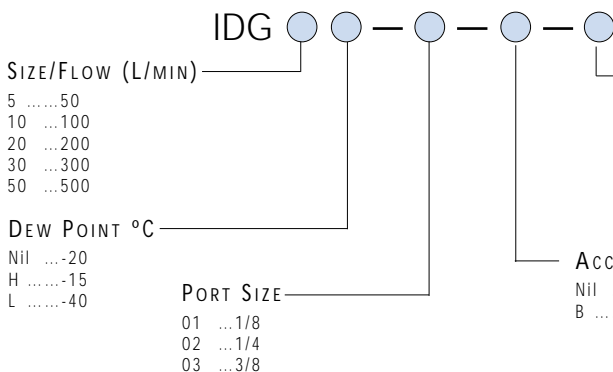

SIZE/FLOW (L/MIN)

5 .....50  
10 ...100  
20 ...200  
30 ...300  
50 ...500

DEW POINT °C

Nil ...-20  
H .....-15  
L .....-40

PORT SIZE

01 ...1/8  
02 ...1/4  
03 ...3/8

#### OPTION

Nil ...Standard  
P .....With one-touch fitting for purge air discharge  
R .....Flow direction (Right to Left)  
S .....With dew point indicator (only with IDG5) - (Other sizes have indicator as standard)

#### ACCESSORIES

Nil ... (standard)  
B .....With bracket

**STOCKED PRODUCTS**  
FOR A LIST OF STOCKED PRODUCTS,  
PLEASE SEE THE CURRENT SMC PRICE LIST

### ACCESSORIES BRACKET SET

BM59	for IDG5, 5H
BM61	for IDG10, 10H
BM63	for IDG20, 20H
BM64	for IDG30, 30H, 30L, 50, 50H, 50L

### ACCESSORIES

#### MEMBRANE MODULE SET

IDG-EL5	for IDG5
IDG-EL5H	for IDG5H
IDG-EL10	for IDG10
IDG-EL10H	for IDG10H
IDG-EL20	for IDG20
IDG-EL20H	for IDG20H
IDG-EL30	for IDG30, 30H, 30L
IDG-EL50	for IDG50, 50H, 50L



### Precautions

#### Operating conditions

- (1) Always use within standard specifications
- (2) Read the Operation manual attached for correct use
- (3) Do NOT use in environments of corrosive gas, compressed air including organic solvent, etc.
- (4) Do NOT use with breathing air equipment.



SEE INSIDE FRONT COVER FOR  
DETAILS OF YOUR LOCAL SALES OFFICE



FOR FURTHER TECHNICAL  
DETAILS ON THIS  
PRODUCT REQUEST

**TECHNICAL  
SPECIFICATIONS**

Reference dew point		-20°C (std type)					-15°C (-H type)					-40°C (-L type)	
Model IDG		5	10	20	30	50	5H	10H	20H	30H	50H	30L	50L
Operating conditions	Fluid	Compressed air											
	Inlet pressure MPa	0.3 to 0.85					0.3 to 1.0					0.3 to 1.0	
	Inlet air temp. °C Note 1	-5 to 55					-5 to 50					-5 to 50	
	Ambient air temp.	-5 to 55					-5 to 50					-5 to 50	
Reference performance	Outlet air atmospheric dew point °C	-20					-15					-40	
Reference performance conditions	Inlet air flow L/min (ANR) Note 2	62	125	250	375	625	56	111	222	335	560	100	150
	Outlet air flow L/min (ANR)	50	100	200	300	500	50	100	200	300	500	75	110
	Purge air flow L/min (ANR) Note 3	12	25	50	75	125	6	11	22	35	60	25	40
	Inlet air pressure MPa	0.7											
	Inlet air temp. °C	25											
	Inlet air saturation temp. °C	25											
	Ambient temp. °C	25											
	Dew point indicator purge air flow	1 L/min (ANR) at inlet air pressure of 0.7MPa											
	Port size	1/8-1/4		1/4-3/8			3/8-1/2			1/2-3/4			
Weight kg (with bracket)	0.25 (0.31)	0.43 (0.51)	0.66 (0.76)	0.74 (0.87)	0.77 (0.90)	0.25 (0.31)	0.43 (0.51)	0.66 (0.76)	0.74 (0.87)	0.77 (0.90)	0.74 (0.87)	0.77 (0.90)	

Note 1) No dew formation

Note 2) ANR indicates the flow rate converting to the stated value at atmospheric pressure at 20°C.

Note 3) It includes dew point indicator purge air flow of 1L/min (ANR) (at 0.7MPa of inlet air pressure) (Except for IDG, 5,5H)

**APPLICATION EXAMPLES  
OF AIR PREPARATION  
(DRYER) COMBINATIONS**

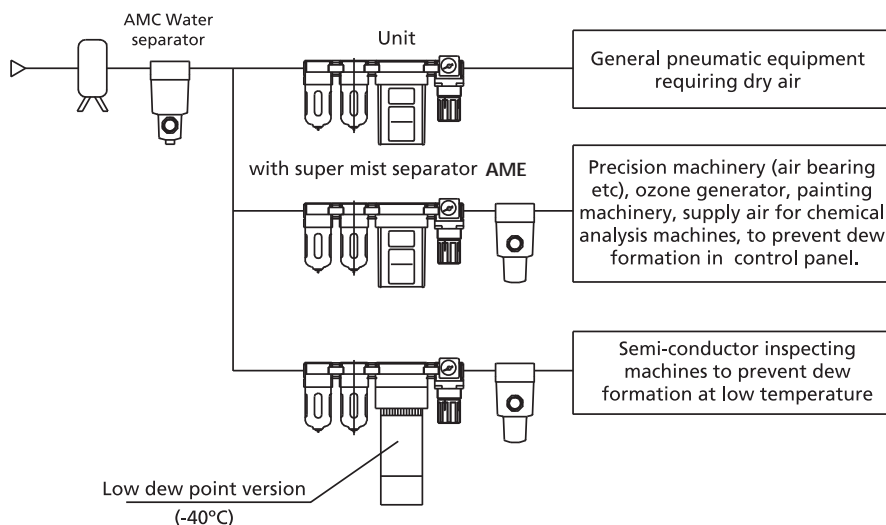

**DIMENSIONS  
SERIES IDG**

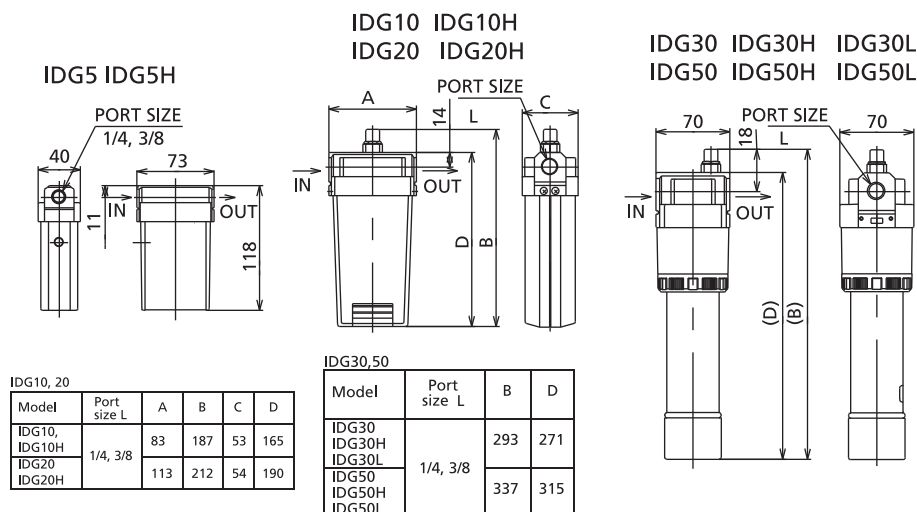

FOR FURTHER TECHNICAL  
DETAILS ON THIS  
PRODUCT REQUEST  
CATALOGUE REFERENCE  
E5G

## MODULAR TYPE – ACCESSORIES

## SPACER

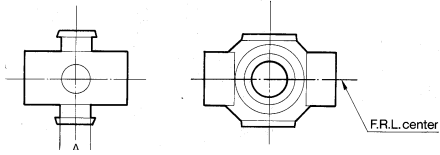
 DIMENSIONS  
SPACER

Model	A	Applicable Model
Y10	8	Ac100-AC1040
Y20	10	AC2000-AC2040
Y30	11	AC2500-AC2540 AC3000-AC3040
Y40	14	AC4000-AC4040
Y50	14	AC4000-06-AC4040-60
Y60	15	AC5000, AC5500, AC6000 AC5020, AC5520, AC6020

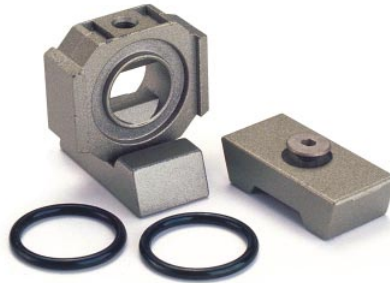

 HOW TO  
ORDER  
SPACER

Y10 ... (1000 SERIES)  
 Y20 ... (2000 SERIES)  
 Y30 ... (3000 SERIES)  
 Y40 ... (4000 SERIES)  
 Y50 ... (4000-06 SERIES)  
 Y60 ... (5/6000 SERIES)

## STOCKED PRODUCTS

FOR A LIST OF STOCKED PRODUCTS, PLEASE SEE THE CURRENT SMC PRICE LIST

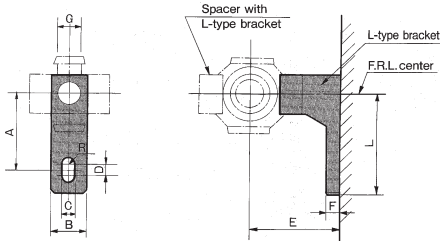
## L TYPE BRACKET

 DIMENSIONS  
L TYPE BRACKET

 HOW TO  
ORDER  
L TYPE BRACKET

1000 SERIES ..... Y10L ..... B110L  
 2000 SERIES ..... Y20L ..... B210L  
 3000 SERIES ..... Y30L ..... B310L  
 4000 SERIES ..... Y40L ..... B410L  
 4000-06 SERIES... Y50L ..... B510L  
 5/6000 SERIES ... Y50L ..... B610L

Spacer with L-type bracket	A	B	C	D	E	F	G	R	L
Y10L	20	12	4.5	3	25	5	8	2.25	27
Y20L	24	15	5.5	3	30	5	10	2.75	33
Y30L	35	16	7	4	41	7	11	3.5	45
Y40L	40	22	9	4	50	7	14	4.5	50
Y50L	40	22	9	4	50	7	14	4.5	50
Y60L	50	24	12	4	70	10	15	6	62.5

## STOCKED PRODUCTS

FOR A LIST OF STOCKED PRODUCTS, PLEASE SEE THE CURRENT SMC PRICE LIST

## T TYPE BRACKET

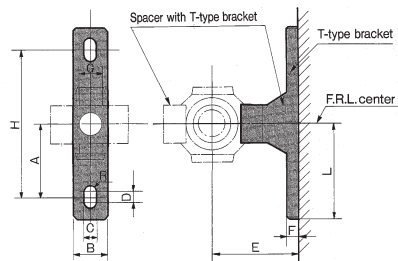
 DIMENSIONS  
T TYPE BRACKET

 HOW TO  
ORDER  
T TYPE BRACKET

1000 SERIES ..... Y10T ..... B110T  
 2000 SERIES ..... Y20T ..... B210T  
 3000 SERIES ..... Y30T ..... B310T  
 4000 SERIES ..... Y40T ..... B410T  
 4000-06 SERIES... Y50T ..... B510T  
 5/6000 SERIES ... Y60T ..... B610T

Spacer with T-type bracket	A	B	C	D	E	F	G	H	R	L
Y10T	20	12	4.5	3	25	5	8	40	2.25	27
Y20T	24	15	5.5	3	30	5	10	40	2.75	33
Y30T	35	16	7	4	41	7	11	70	3.5	45
Y40T	40	22	9	4	50	7	14	80	4.5	50
Y50T	40	22	9	4	50	7	14	80	4.5	50
Y60T	50	24	12	4	70	10	15	100	6	62.5

## STOCKED PRODUCTS

FOR A LIST OF STOCKED PRODUCTS, PLEASE SEE THE CURRENT SMC PRICE LIST



SEE INSIDE FRONT COVER FOR DETAILS OF YOUR LOCAL SALES OFFICE



FOR FURTHER TECHNICAL DETAILS ON THIS PRODUCT REQUEST CATALOGUE REFERENCE E5G



### END BLOCK ADAPTOR



- ✓ Port sizes: M5 - 1" Rc
- ✓ Allows for easy installation and maintenance

**HOW TO ORDER**  
PIPING ADAPTOR

- E10-M5 ..... 1000 SERIES
- E20-01 ..... 2000 SERIES
- E20-02 ..... 2000 SERIES
- E20-03 ..... 2000 SERIES
- E30-02 ..... 3000 SERIES
- E30-03 ..... 3000 SERIES
- E30-04 ..... 3000 SERIES
- E40-03 ..... 4000 SERIES
- E40-04 ..... 4000 SERIES
- E40-06 ..... 4000 SERIES
- E50-06 ..... 4000-06 SERIES
- E60-06 ..... 5/6000 SERIES
- E60-10 ..... 5/6000 SERIES

**DIMENSIONS**  
PIPING ADAPTOR

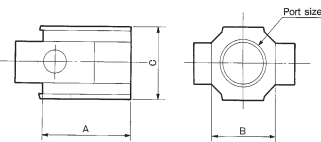

Model	Port size	A	B	C
E10-M5	M5x0.8	16	17.5	14
E20-01	1/8	23	22	22
E20-02	1/4			
E20-03	3/8			
E30-02	1/4	26	34.2	29
E30-03	3/8			
E30-04	1/2	40	34.2	29
E40-03	3/8	33	42.2	35
E40-04	1/2			
E40-06	3/4	50	42.2	35
E50-06	3/4	36	44	46.2
E60-06	3/4	40	54	55.2
E60-10	1			

**STOCKED PRODUCTS**  
FOR A LIST OF STOCKED PRODUCTS,  
PLEASE SEE THE CURRENT SMC PRICE LIST

### BRANCHING UNITS

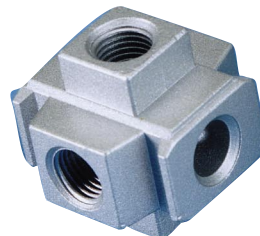

**DIMENSIONS**  
T TAKE OFF

Cannot be installed adjacent to combined filter/regulator unit

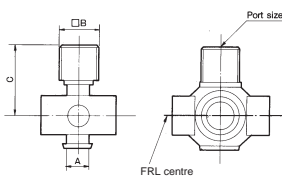

Model	Port Size	A	B	C
Y11-M5	M5X0.8	8	12	8
Y21-01	1/8	10	29	19
Y21-02	1/4	10	29	19
Y31-01	1/8	11	33	19
Y31-02	1/4	11	33	19
Y41-02	1/4	14	39	24
Y41-03	3/8	14	39	24
Y51-02	1/4	14	24	41
Y51-03	3/8	14	24	41
Y61-03	3/8	15	30	50.5
Y61-04	1/2	15	30	50.5

**DIMENSIONS**  
X TAKE OFF

Fits between modular units using 'Y' type connectors

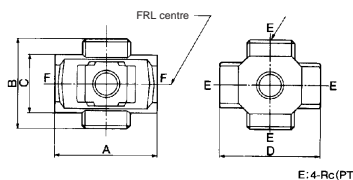

Model	Port Size	A	B	C	D
Y14-M5	M5	23	16	14	25
Y24-01	1/8	40	40	22	40
Y24-02	1/4	40	40	22	40
Y34-02	1/8	49	43	28	48
Y44-02	1/4	60	48	36	54
Y44-03	3/8	60	48	36	54
Y54-03	3/8	72	62	40	62
Y54-04	1/2	72	62	40	62

**HOW TO ORDER**  
"T" TAKE-OFF

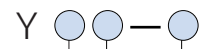

**APPLICABLE FRL SERIES**

- 1 ..... 1000
- 2 ..... 2000
- 3 ..... 3000
- 4 ..... 4000
- 5 ..... 4000-06
- 6 ..... 5000, 6000

**TAKE-OFF TYPE**

- 1 ..... "T" Type
- 4 ..... "X" Type

**PORT SIZE**

- M5 ... M5 x 0.8
- 01 ... Rc 1/8
- 02 ... Rc 1/4
- 03 ... Rc 3/8
- 04 ... Rc 1/2

**STOCKED PRODUCTS**  
FOR A LIST OF STOCKED PRODUCTS,  
PLEASE SEE THE CURRENT SMC PRICE LIST

Air Preparation



FOR FURTHER TECHNICAL  
DETAILS ON THIS  
PRODUCT REQUEST  
CATALOGUE REFERENCE  
E5G