

Optocoupler, Non Zero Crossing Phototriac, 1.5 kV/ μ s dV/dt, 600 V

Features

- 1500 V/ μ s dV/dT minimum, 2000 V/ μ s typical
- 600 V Blocking Voltage
- Low Input Trigger Current
- 6 pin DIP package
- Lead (Pb)-free component
- Component in accordance to RoHS 2002/95/EC and WEEE 2002/96/EC



RoHS
COMPLIANT

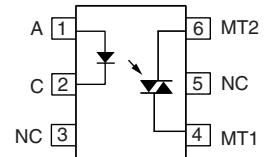
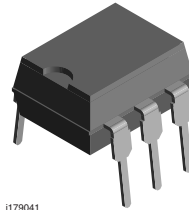
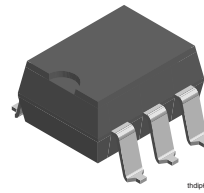

Agency Approvals

- UL - File E52744 H/J System Code
- CUL - File No. E52744, equivalent to CSA bulletin 5A
- DIN EN 60747-5-2 (VDE0884)
DIN EN 60747-5-5 pending
Available with Option 1

Description

The VO3052/VO3053 triac driver family consists of a GaAs infrared LED optically coupled to a monolithic photosensitive non zero crossing triac detector chip. The 600 V blocking voltage permits control of off-line voltages up to 240 VAC, with a safety factor or more than two, and is sufficient for as much as 380 V.

Applications

- Household Appliances
- Triac Drive/AC Motor Drives
- Solenoid/Valve Controls
- Office Automation Equipment / Machine
- Temperature (HVAC)/Lighting Controls
- Switching Power Supply

Order Information

Part	Remarks
VO3053	DIP-6, NZC, 600 V, $I_{ft} = 5$ mA
VO3052	DIP-6, NZC, 600 V, $I_{ft} = 10$ mA
VO3053-X006	DIP-6 400 mil (option 6), NZC, 600 V, $I_{ft} = 5$ mA
VO3052-X006	DIP-6 400 mil (option 6), NZC, 600 V, $I_{ft} = 10$ mA
VO3053-X007T	SMD-6 (option 7), NZC, 600 V, $I_{ft} = 5$ mA
VO3052-X007T	SMD-6 (option 7), NZC, 600 V, $I_{ft} = 10$ mA

Absolute Maximum Ratings

$T_{amb} = 25$ °C, unless otherwise specified

Stresses in excess of the absolute Maximum Ratings can cause permanent damage to the device. Functional operation of the device is not implied at these or any other conditions in excess of those given in the operational sections of this document. Exposure to absolute Maximum Rating for extended periods of the time can adversely affect reliability.

Input

Parameter	Test condition	Symbol	Value	Unit
Reverse voltage		V_R	6.0	V
Forward current - continuous		I_F	60	mA
Power dissipation		P_{diss}	100	mW

Output

Parameter	Test condition	Part	Symbol	Value	Unit
Off state output terminal voltage		VO3052/3053	V_{DRM}	600	V
Peak repetitive surge current	PW = 100 ms, 120 pps		I_{TSM}	1.0	A
Power dissipation			P_{diss}	150	mW

Coupler

Parameter	Test condition	Symbol	Value	Unit
Isolation test voltage	1.0 sec	V_{ISO}	5300	V_{RMS}
Total power dissipation		P_{tot}	250	mW
Operating temperature		T_{amb}	- 40 to + 100	°C
Storage temperature		T_{stg}	- 55 to + 150	°C
Soldering temperature	10 sec	T_{sld}	260	°C

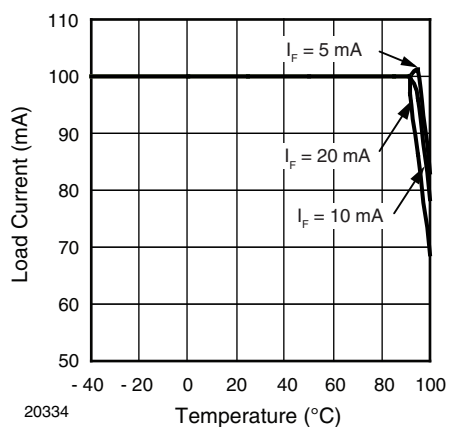
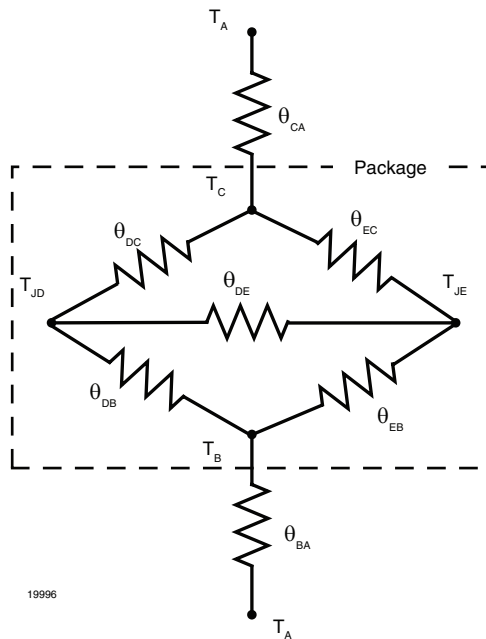

Figure 1. On State Current vs. Temperature

Thermal Characteristics

The thermal model is represented in the thermal network below. Each resistance value given in this model can be used to calculate the temperatures at each node for a given operating condition. The thermal resistance from board to ambient will be dependent on the type of PCB, layout and thickness of copper traces. For a detailed explanation of the thermal model, please reference Vishay's Thermal Characteristics of Optocouplers Application note.

Parameter	Test condition	Symbol	Value	Unit
LED Power dissipation	at 25 °C	P_{diss}	100	mW
Output Power dissipation	at 25 °C	P_{diss}	500	mW
Total Power dissipation	at 25 °C	P_{tot}	600	mW
Maximum LED junction temperature		T_{jmax}	125	°C
Maximum output die junction temperature		T_{jmax}	125	°C
Thermal resistance, Junction Emitter to Board		θ_{JEB}	150	°C/W
Thermal resistance, Junction Emitter to Case		θ_{JEC}	139	°C/W
Thermal resistance, Junction Detector to Board		θ_{JDB}	78	°C/W
Thermal resistance, Junction Detector to Case		θ_{JDC}	109	°C/W
Thermal resistance, Junction Emitter to Junction Detector		θ_{JED}	496	°C/W
Thermal resistance, Case to Ambient		θ_{CA}	9563	°C/W



Electrical Characteristics

$T_{amb} = 25\text{ °C}$, unless otherwise specified

Minimum and maximum values are testing requirements. Typical values are characteristics of the device and are the result of engineering evaluation. Typical values are for information only and are not part of the testing requirements.

Input

Parameter	Test condition	Symbol	Min	Typ.	Max	Unit
Reverse current	$V_R = 6\text{ V}$	I_R			10	μA
Forward voltage	$I_F = 30\text{ mA}$	V_F		1.2	1.5	V

Output

Parameter	Test condition	Symbol	Min	Typ.	Max	Unit
Leakage with LED off, either direction	$V_{DRM} = 600\text{ V}$	I_{DRM}		10	500	nA
Critical rate of rise of off-state voltage	$V_D = 400\text{ V}$	dV/dt	1500	2000		V/ μ s

Coupler

Parameter	Test condition	Part	Symbol	Min	Typ.	Max	Unit
LED trigger current, current required to latch output		VO3053	I_{FT}			5	mA
		VO3052	I_{FT}			10	mA
Peak on-state voltage, either direction	$I_{TM} = 100\text{ mA Peak}$, $I_F = \text{Rated } I_{FT}$		V_{TM}		1.7	3	V
Holding current, either direction			I_H		200		μ A

Safety and Insulation Ratings

As per IEC60747-5-2, §7.4.3.8.1, this optocoupler is suitable for "safe electrical insulation" only within the safety ratings. Compliance with safety ratings shall be ensured by means of protective circuits.

Parameter	Test condition	Symbol	Min	Typ	Max	Unit
Climatic classification	IEC 68 part 1			40/100/21		
Pollution degree	DIN VDE 0109			2		
Tracking resistance (Comparative tracking index)	Insulation group IIIa	CTI	175			
Highest allowable overvoltage	Transient overvoltage	V_{IOTM}	8000			V_{peak}
Maximum working insulation voltage	Recurring peak voltage	V_{IORM}	890			V_{peak}
Insulation resistance at 25 °C	$V_{IO} = 500\text{ V}$	R_{IS}			$\geq 10^{12}$	Ω
Insulation resistance at T_S	$V_{IO} = 500\text{ V}$	R_{IS}			$\geq 10^{12}$	Ω
Insulation resistance at 100 °C	$V_{IO} = 500\text{ V}$	R_{IS}			$\geq 10^{12}$	Ω
Partial discharge test voltage	Method a, $V_{pd} = V_{IORM} \times 1.875$	V_{pd}			1669	V_{peak}
Safety limiting values - Maximum values allowed in the event of a failure: Case temperature Input current Output power		T_{SI} I_{SI} P_{SO}			175 250 500	°C mA mW
Minimum external air gap (Clearance)	Measured from input terminals to output terminals, shortest distance through air		≥ 7			mm
Minimum external tracking (Creepage)	Measured from input terminals to output terminals, shortest distance path along body		≥ 7			mm
Minimum external air gap (Clearance)	Measured from input terminals to output terminals, shortest distance through air		≥ 8			mm
Minimum external tracking (Creepage)	Measured from input terminals to output terminals, shortest distance path along body		≥ 8			mm

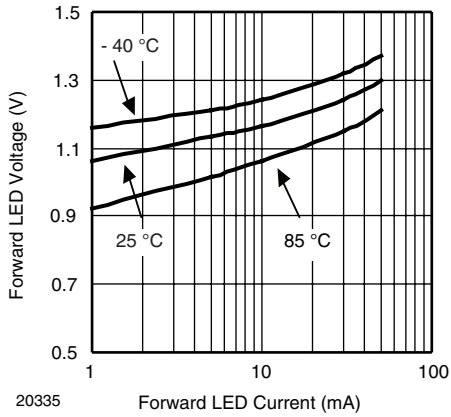

20335
Figure 2. Forward Voltage vs. Forward Current

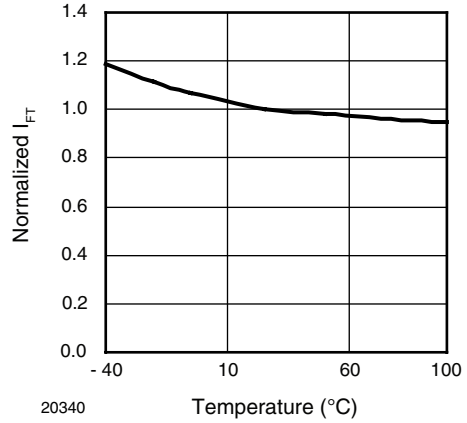

20340
Figure 5. Normalized Trigger Current vs. Temperature

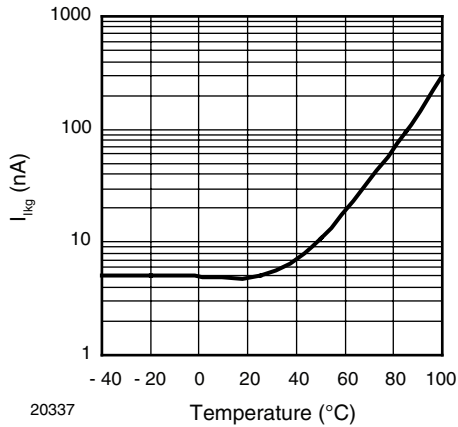

20337
Figure 3. Off-State Leakage Current vs. Temperature

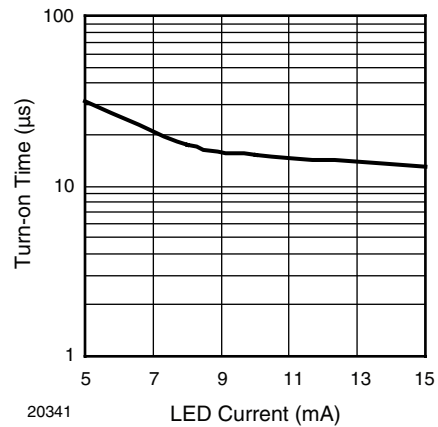

20341
Figure 6. Turn-On Time vs. LED Current

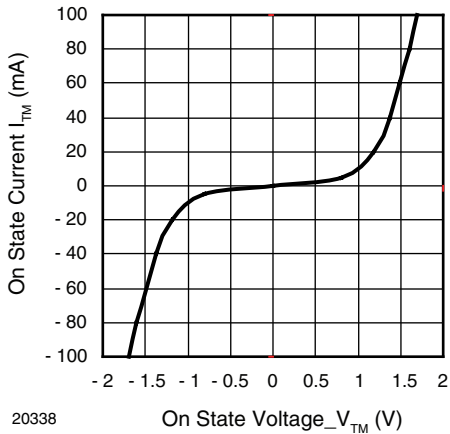

20338
Figure 4. On State Current vs. V_{TM}

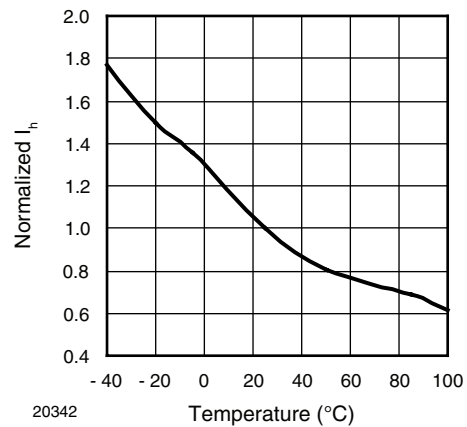

20342
Figure 7. Normalized Holding Current vs. Temperature

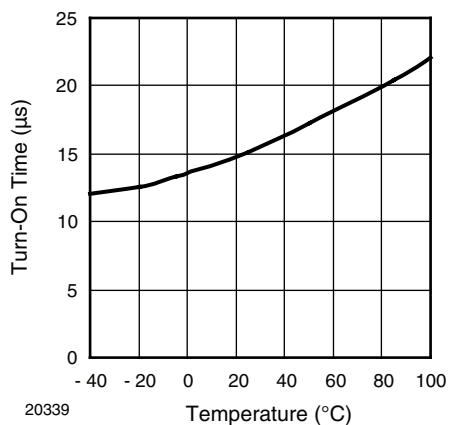

Figure 8. Turn-On Time vs. Temperature

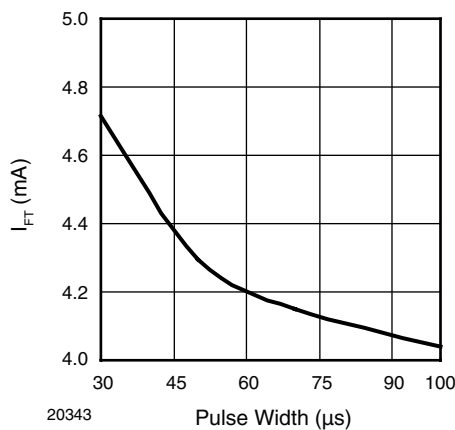
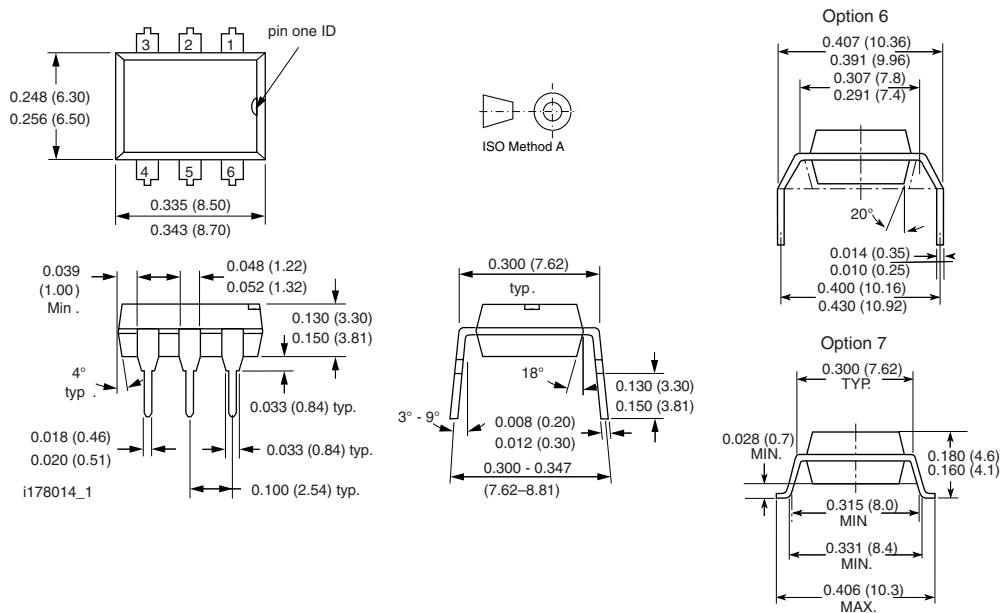

Figure 9. Trigger Current vs. Pulse Width

Package Dimensions in Inches (mm)





Ozone Depleting Substances Policy Statement

It is the policy of Vishay Semiconductor GmbH to

1. Meet all present and future national and international statutory requirements.
2. Regularly and continuously improve the performance of our products, processes, distribution and operating systems with respect to their impact on the health and safety of our employees and the public, as well as their impact on the environment.

It is particular concern to control or eliminate releases of those substances into the atmosphere which are known as ozone depleting substances (ODSs).

The Montreal Protocol (1987) and its London Amendments (1990) intend to severely restrict the use of ODSs and forbid their use within the next ten years. Various national and international initiatives are pressing for an earlier ban on these substances.

Vishay Semiconductor GmbH has been able to use its policy of continuous improvements to eliminate the use of ODSs listed in the following documents.

1. Annex A, B and list of transitional substances of the Montreal Protocol and the London Amendments respectively
2. Class I and II ozone depleting substances in the Clean Air Act Amendments of 1990 by the Environmental Protection Agency (EPA) in the USA
3. Council Decision 88/540/EEC and 91/690/EEC Annex A, B and C (transitional substances) respectively.

Vishay Semiconductor GmbH can certify that our semiconductors are not manufactured with ozone depleting substances and do not contain such substances.

We reserve the right to make changes to improve technical design
and may do so without further notice.

Parameters can vary in different applications. All operating parameters must be validated for each customer application by the customer. Should the buyer use Vishay Semiconductors products for any unintended or unauthorized application, the buyer shall indemnify Vishay Semiconductors against all claims, costs, damages, and expenses, arising out of, directly or indirectly, any claim of personal damage, injury or death associated with such unintended or unauthorized use.

Vishay Semiconductor GmbH, P.O.B. 3535, D-74025 Heilbronn, Germany



Notice

Specifications of the products displayed herein are subject to change without notice. Vishay Intertechnology, Inc., or anyone on its behalf, assumes no responsibility or liability for any errors or inaccuracies.

Information contained herein is intended to provide a product description only. No license, express or implied, by estoppel or otherwise, to any intellectual property rights is granted by this document. Except as provided in Vishay's terms and conditions of sale for such products, Vishay assumes no liability whatsoever, and disclaims any express or implied warranty, relating to sale and/or use of Vishay products including liability or warranties relating to fitness for a particular purpose, merchantability, or infringement of any patent, copyright, or other intellectual property right.

The products shown herein are not designed for use in medical, life-saving, or life-sustaining applications. Customers using or selling these products for use in such applications do so at their own risk and agree to fully indemnify Vishay for any damages resulting from such improper use or sale.