

EE-SPX74/84

Compact Sensor for High-Density Mounting with Easy Snap-In Connector

- Connector features a built-in safety lock for shock and vibration resistance
- Sensor replacement made simple without rewiring
- Cables can be bent and used in a minimal amount of space
- Powerful light modulation against external light interference
- Variety of models available with an option to change from connector to pre-wired (EE-SPX-W Series)



Ordering Information

■ EE-SPX74/84

Appearance	Sensing Method	Slot Width	Slot Depth	Output configuration	Weight	Part number
	Slot	3.6 mm	6.6 mm	Dark ON	Approx. 2.4g	EE-SPX740
				Light ON		EE-SPX840
				Dark ON		EE-SPX742
				Light ON		EE-SPX842
	Slot	3.6 mm	6.6 mm	Dark-ON	Approx. 2.4g	EE-SPX743
				Light-ON		EE-SPX843
	Slot	5.0 mm	9.0 mm	Dark-ON	Approx. 2.4g	EE-SPX741
				Light-ON		EE-SPX841

■ ACCESSORIES

Name	Part number
Connector with 1 m cable	EE-1013

Specifications

■ RATINGS/CHARACTERISTICS

Item	EE-SPX740, EE-SPX840 EE-SPX742, EE-SPX842 EE-SPX743, EE-SPX843	EE-SPX741 EE-SPX841
Sensing distance	3.6 mm (slot width)	5 mm (slot width)
Standard sensing object	Opaque: 1 x 0.5 mm min	Opaque: 2 x 0.8 mm min
Differential travel	0.05 mm max.	
Light source (peak emission wavelength)	GaAs infrared LED (pulse modulated) (940 nm)	
Indicator (see note 1)	Indicator (red) lit with incidence	
Power supply voltage	5 to 24 VDC ± 10%, ripple (p-p): 5% max.	
Current consumption	Average value: 15 mA max., Peak value: 50 mA max.	
Control output	NPN voltage output: Load source voltage of 5 to 24 VDC and load current of 50 mA max. Residual voltage: 1.0 V max. (at load current 50 mA) Residual voltage: 0.4 V max. (at load current 10 mA)	
Response frequency (see note 2)	500 Hz	
Ambient illuminance	Sensing surface: 3,000 lx max. with incandescent light and sunlight	
Ambient temperature	Operating: -10°C to 55°C (14°F to 131°F) Storage: -25°C to 65°C (-13°F to 149°F)	
Ambient humidity	Operating: 5% to 85% Storage: 5% to 95%	
Vibration resistance	Destruction: 10 to 55 Hz, 1.5-mm double amplitude for 2 hours each in X, Y, and Z directions	
Shock resistance	Destruction: 500 m/s ² , three times each in X, Y, and Z directions	
Enclosure rating	IEC60529 IP50	
Connection method (standard length)	Connector	
Weight	Approx. 2.4 g	
Casing material	Polycarbonate	

Note: 1. The indicator is a GaAlAs red LED (peak emission wavelength: 660 nm).

2. The value for response frequency was obtained using the EE-SPX on a rotating disc with holes in it as shown below.

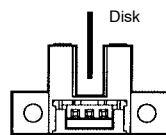
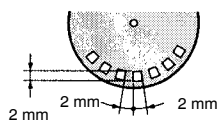

EE-SPX741/841

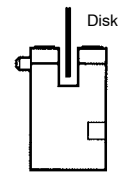

EE-SPX742/842
EE-SPX743/843

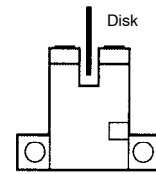

EE-SPX740/840

Engineering Data

■ SENSING POSITION

EE-SPX740/742/743

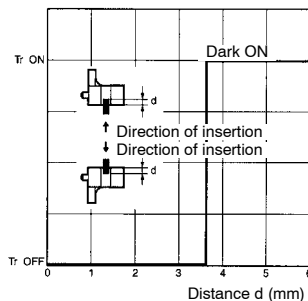

EE-SPX741

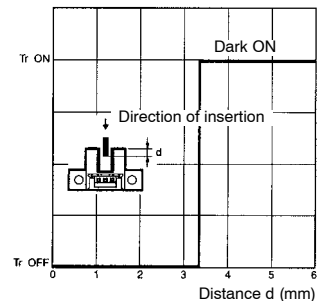
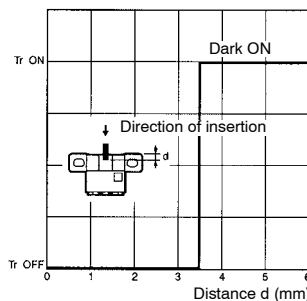
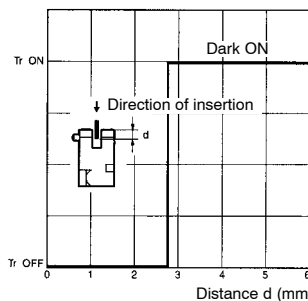

Operation

OUTPUT CIRCUITS

Output configuration	Model	Output transistor operation	Timing charts	Output circuit
NPN output	EE-SPX740 EE-SPX741 EE-SPX742 EE-SPX743	Dark ON	<p>Light ON</p>	<p>Note: Voltage output (when connected to a transistor circuit or similar circuit)</p>
	EE-SPX840 EE-SPX841 EE-SPX842 EE-SPX843	Light ON	<p>Light ON</p>	

Dimensions

Unit: mm (inch)

EE-SPX740 EE-SPX840

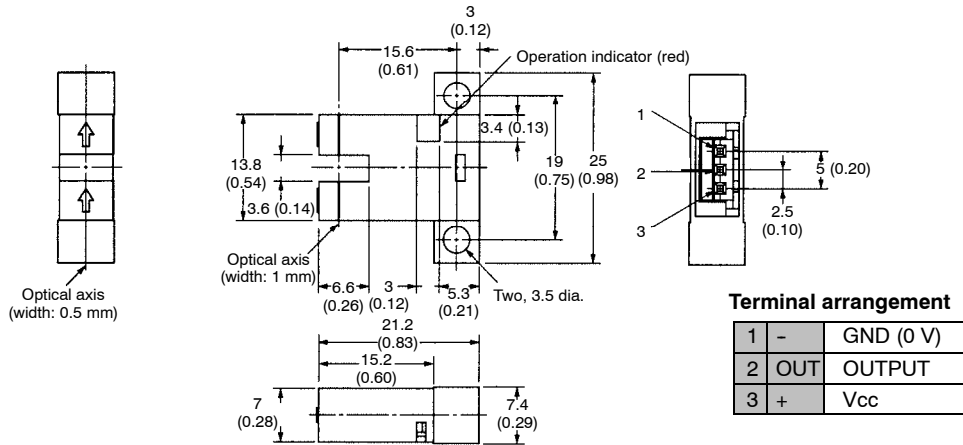

EE-SPX742 EE-SPX842

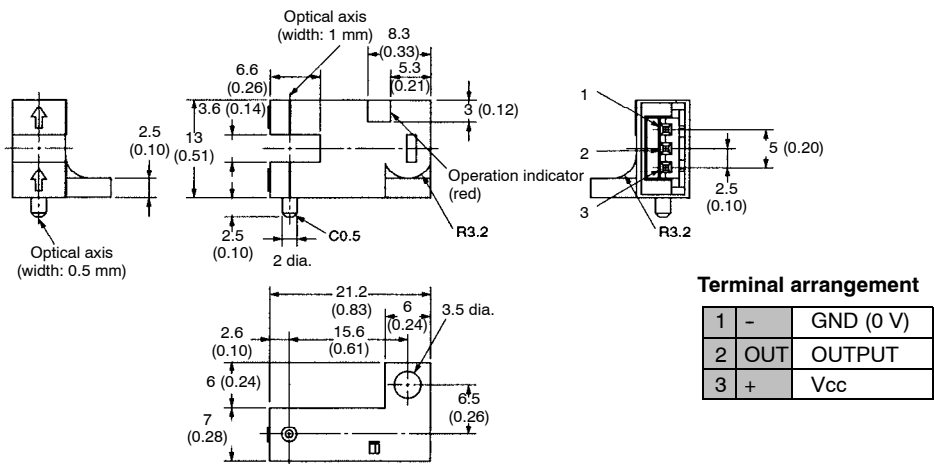

■ EE-SPX743
EE-SPX843

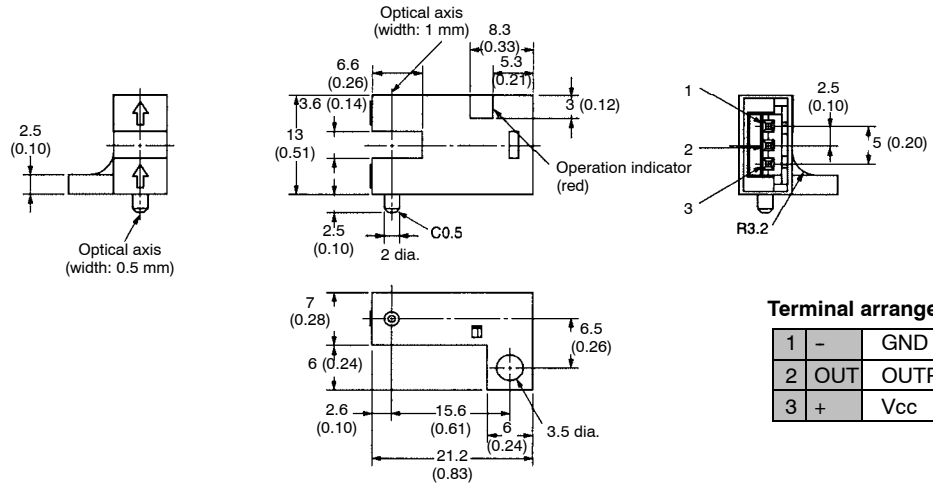

Terminal arrangement

1	-	GND (0 V)
2	OUT	OUTPUT
3	+	Vcc

■ EE-SPX741
EE-SPX841

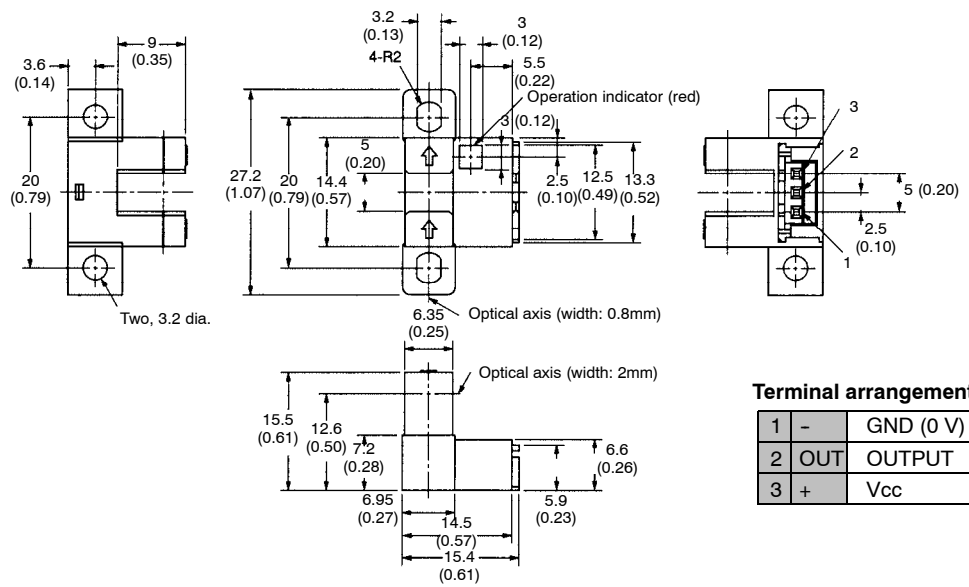

Terminal arrangement

1	-	GND (0 V)
2	OUT	OUTPUT
3	+	Vcc

Unit: mm (inch)

■ ACCESSORIES (CONNECTOR WITH CABLE)

EE-1013

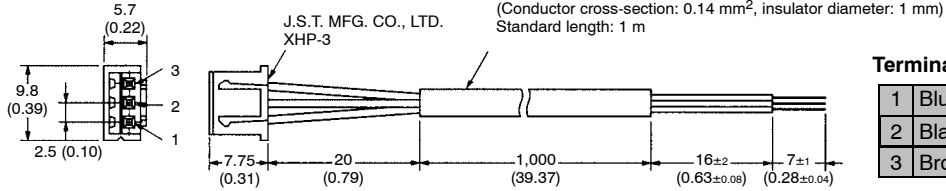

Terminal arrangement

1	Blue	GND (0 V)
2	Black	OUTPUT
3	Brown	Vcc

Refer to the following when using a non-dedicated connector.

Manufacturer	J.S.T. MFG. CO., LTD.	
Housing	XHP-3	
Contact	SXH-001T-P0.6	
Applied power line	Cross section	0.162 to 0.324 mm ²
	AWG#	25 to 22
	Insulator diameter	1.2 to 1.9 mm

- Note: 1. For details, consult the manufacturer.
 2. The applicable range for the applied power line is different from that specified by the manufacturer (AWG# 28 to 22).
 3. When using a cable longer than 4 m, refer to *Correct Design Setup* in the *Precautions* section.

Precautions

■ INSTALLATION CONNECTIONS

Do not connect the EE-SPX to an AC (100 VAC) power supply. Doing so may cause ignition, burning, or other damage.

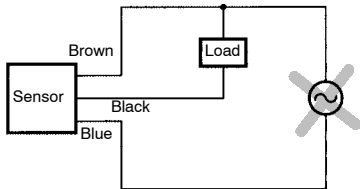

Do not use the EE-SPX at voltages exceeding the rated voltage range. Doing so may cause the EE-SPX to be damaged or burned.

Wire the EE-SPX correctly with the correct polarity. Failure to do so may cause the EE-SPX to be damaged or burned.

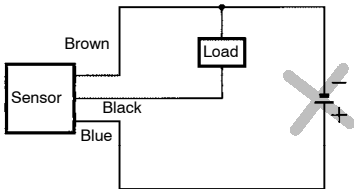

Do not short-circuit the load (i.e., do not connect a power supply directly to the Sensor) as shown below. Doing so may cause the EE-SPX to be damaged or burned.

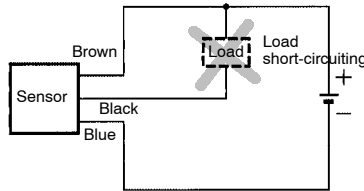

■ CORRECT DESIGN SETUP

Cable Extensions

Use a cable with a minimum wiring cross-section surface area of 0.15 mm² and no greater than 4 m in length. If the wiring exceeds 4 m, connect a 10 μF capacitor within the 4 m mark, as shown in the diagram. (Use a condenser with a withstand pressure of at least twice the sensor power source voltage.)

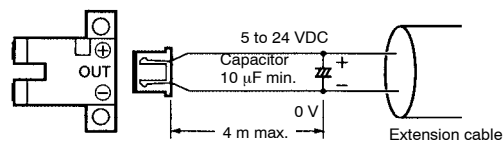

Power Source

When using a switching regulator on general sale, take the following countermeasures.

1. Connect a 0 V line to the power source near the sensor to reduce impedance from the mounting, so as to prevent induction noise in the vicinity of the sensor. Also, connect the line via a capacitor (up to 0.47 μF).

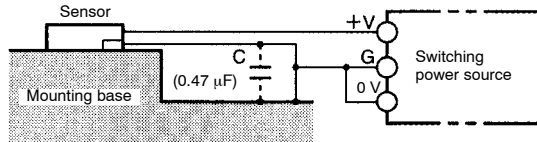

2. Connect a noise filter terminal (middle point terminal to ACG) for the switching power source to the body of equipment (FG) for the power source and the 0 V.

A more stable operation can be obtained by connecting the already-connected line to ground or to the mounting (as recommended by all power source manufacturers).

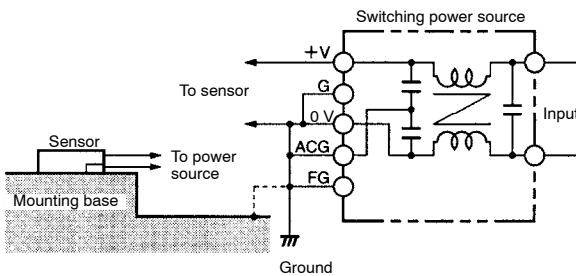

3. Insert a plastic insulator about 10 mm thick between the sensor and the mounting.

Effects of Induced Noise

If there is induced noise in the (metal) mounting of the sensor, it may cause an effect similar to light ON in the sensor. In such a case, connect the photomicrosensor 0 V terminal and the (metal) mounting at the same electric potential. Also, connect the 0 V terminal and the metal mounting via a 0.47 μF capacitor.

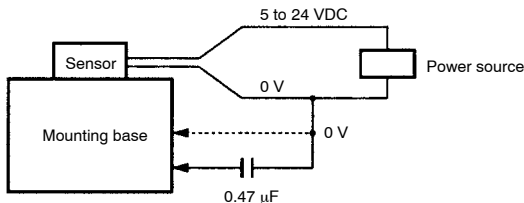

MOUNTING

Be sure to mount the Sensor securely to flat plates. The characteristics of the Through-beam Sensor change if the slot is deformed.

Use M3.0 screws when mounting the EE-SPX. Be sure to use spring washers with the screws so that the screws will not loosen. The tightening torque applied to each screw must be no more than 0.59 N • m (6 kgf • cm).

Make sure that nothing will come into contact with the sensing element of the Sensor. If the sensing element has scratch damage, the characteristics of the Sensor will decrease.

Make sure that the EE-SPX is securely mounted and not loosened by vibration or shock.

WIRING

Countermeasures Against Surge

If the power supply has surge voltage, connect a Zener diode withstanding 30 to 35 V or 0.1 to 1- μF capacitor in parallel to the power supply to absorb the surge voltage.

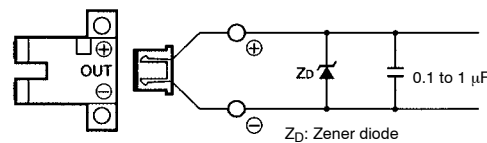

If the load is a relay or other small inductive load, connect the load to the EE-SPX as shown below. Be sure to connect a diode for counter-voltage absorption.

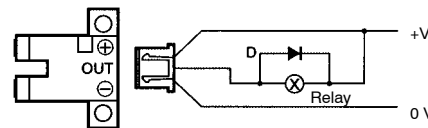

Do not wire power lines or high-tension lines alongside the lines of the EE-SPX in the same conduit, otherwise the EE-SPX may be damaged or malfunction due to induction. Be sure to wire the lines of the EE-SPX separately from power lines or high-tension lines or lay them in an exclusive, shielded conduit.

ENVIRONMENT

Do not wire the EE-SPX while power is applied, or the EE-SPX may be damaged.

To avoid damage or malfunction, do not install the EE-SPX in the following locations:

- Locations with excessive dust
- Locations with corrosive gas
- Locations where water, oil, or chemical is directly sprayed
- Outdoors or locations exposed to direct sunlight

Make sure that the ambient operating temperature is within the rated range.

The Sensor may be soluble in organic solvent, acid, and alkaline, aromatic hydrocarbon, and chlorinated aliphatic hydrocarbon solvents. The characteristics of the Sensor may decrease as a result, so make sure that the Sensor is free from these solutions.

NOTE: DIMENSIONS SHOWN ARE IN MILLIMETERS. To convert millimeters to inches divide by 25.4.

OMRON[®]

OMRON ELECTRONICS LLC

One East Commerce Drive
Schaumburg, IL 60173

1-800-55-OMRON

OMRON ON-LINE

Global - <http://www.omron.com>
USA - <http://www.omron.com/oei>
Canada - <http://www.omron.com/oci>

OMRON CANADA, INC.

885 Milner Avenue
Toronto, Ontario M1B 5V8

416-286-6465