

SPECIFICATION FOR COTCO LED LAMP

MODEL No : LP377TYL1-A0G-MT
DOC. No : 02 11Nov04

Description:

100 Degree 7.6 x 7.6mm LED Lamp in
Amber Color with Water Transparent Lens
and Stopper

*This specification is only for MT

Dice Material: AlGaInP

Confirmed
by Customer: _____

Date: _____

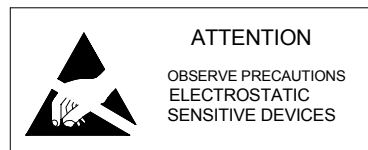

COTCO LUMINANT DEVICE (HUIZHOU) LTD.



For part availability and ordering information please call Toll Free: 800.984.5337
Website: www.marktechopto.com | Email: info@marktechopto.com

Applications:

- Advertising Signs
- Indicators
- Automotive Lighting

Absolute Maximum Ratings at Ta = 25°C

Items	Symbol	Absolute maximum Rating	Unit
Forward Current ^{*2}	I _F	70	mA
Peak Forward Current ^{*1}	I _{FP}	200	mA
Reverse Voltage	V _R	5	V
Power Dissipation	P _D	220	mW
Operation Temperature	T _{opr}	-40 ~ +100	°C
Storage Temperature	T _{stg}	-40 ~ +100	°C
Lead Soldering Temperature	T _{sol}	Max.260°C for 5 sec Max. (3mm from the base of the epoxy bulb)	

*1 pulse width <=0.1msec duty <=1/10

*2 Heat sink is recommended to be adequated if the device is operated at ambient temperatures higher than 25 deg C. For long term performance the drive currents between 10mA and 50mA are recommended. Please contact COTCO sales representative for more information on recommended drive conditions.

Dimension Drawing

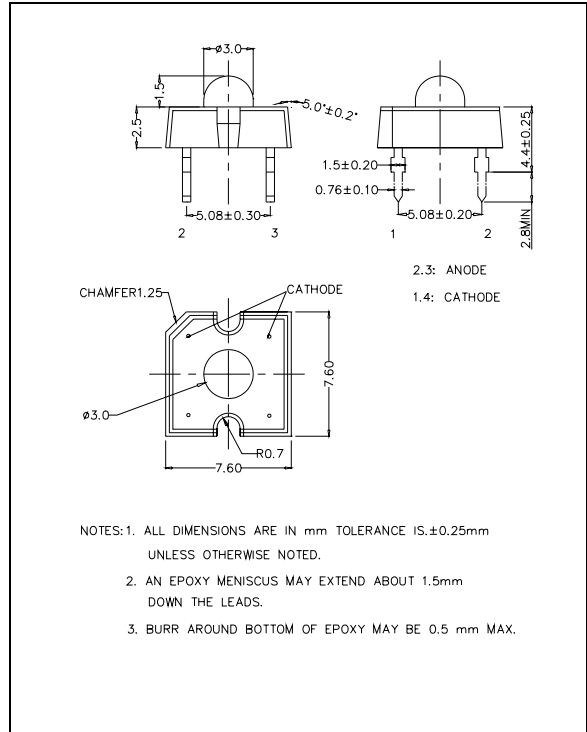

Typical Electrical & Optical Characteristics (Ta = 25°C)

Items	Symbol	Condition	Min.	Typ.	Max.	Unit
Forward Voltage	V _F	I _F = 70mA	---	2.6	3.2	V
Reverse Current	I _R	V _R = 5V	---	---	100	μA
Dominant Wavelength	λ _D	I _F = 70mA	584	591	599	nm
Luminous Flux	Φ _V	I _F = 70mA	2000	3200	---	mlm
50% Power Angle	2θ _½	I _F = 70mA	---	100	---	deg

Model No.	LP377TYL1-A0G-MT
Doc. No.	02 11Nov04

Standard bins for LP377TYL1-A0G-MT ($I_F = 70\text{mA}$):

Lamps are sorted to Luminous Flux – Φ_V , V_F & Dominant Wavelength – λ_D bins shown.

Orders for LP377TYL1-A0G-MT may be filled with any or all bins contained as below.

All Luminous Flux – Φ_V , V_F & Dominant Wavelength – λ_D values shown and specified are at $I_f=70\text{mA}$.

*** G+**

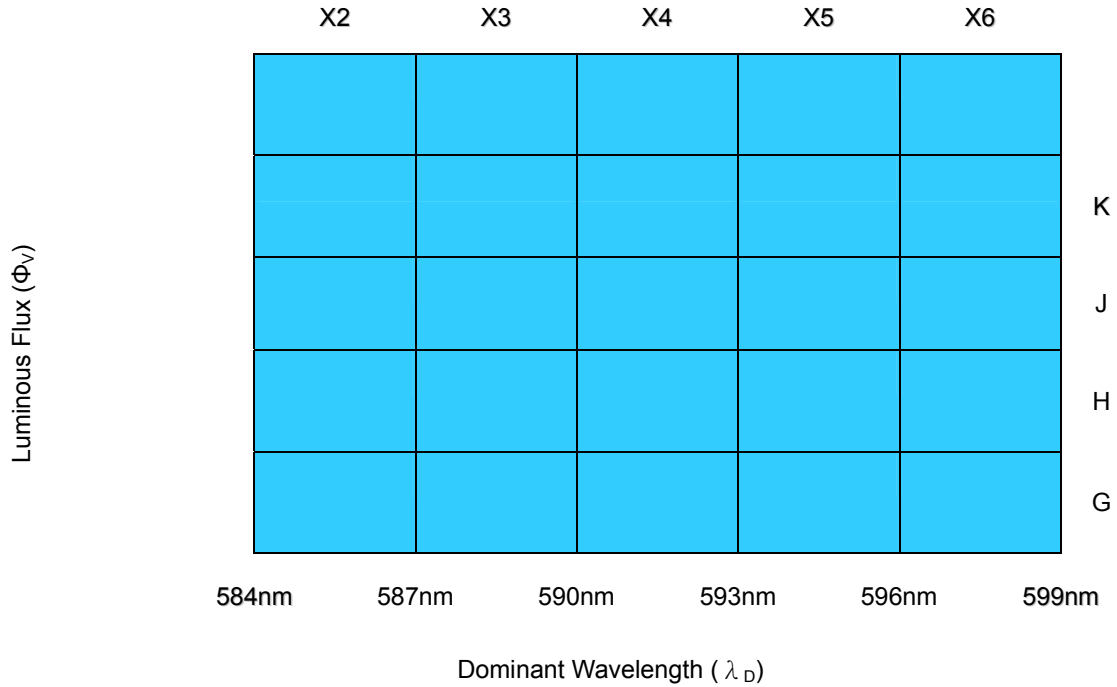

Rank	G	H	J	K
Luminous Flux	2000-3000 mlm	2500-3600 mlm	3000-4200 mlm	3500-4800 mlm

* G+ indicates Luminous Flux is at G bin or above.

Forward Voltage (V_F)

Rank	V4	V5	V6	V7	V8
Voltage	2.2-2.4V	2.4-2.6V	2.6-2.8V	2.8-3.0V	3.0-3.2 V

Important Notes:

- 1) All ranks will be included per delivery, rank ratio will be determined by Cotco.
- 2) No tolerance in the measurement of luminous flux.
- 3) Tolerance of measurement of dominant wavelength is $\pm 1\text{nm}$.
- 4) Tolerance of measurement of V_f is $\pm 0.05\text{ V}$.
- 5) Packaging methods are available for selection, please refer to PACKAGING STANDARD.
- 6) Please refer to LED LAMP RELIABILITY TEST STANDARD for reliability test conditions.

Graphs

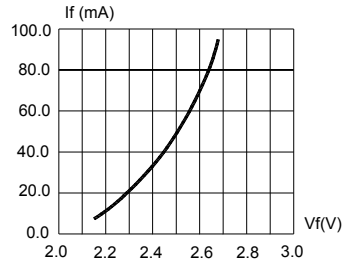

FIG.1 FORWARD CURRENT VS. FORWARD VOLTAGE.

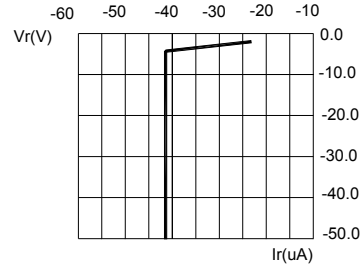

FIG.2 REVERSE CURRENT VS. REVERSE VOLTAGE.

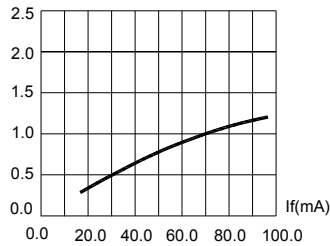

FIG.3 RELATIVE LUMINOUS FLUX VS. FORWARD CURRENT.

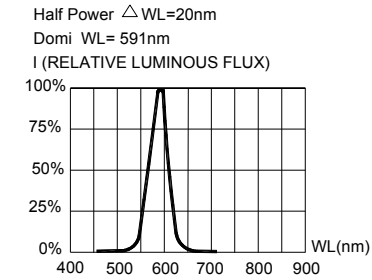

FIG.4 RELATIVE LUMINOUS FLUX VS. WAVELENGTH.

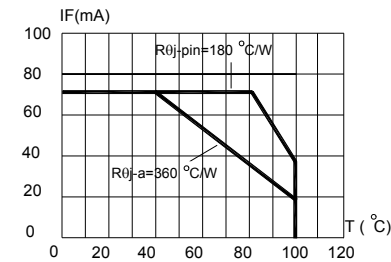

FIG.5 MAXIMUM FORWARD DC CURRENT VS AMBIENT TEMPERATURE ($T_{jmax}=120^{\circ}C$)

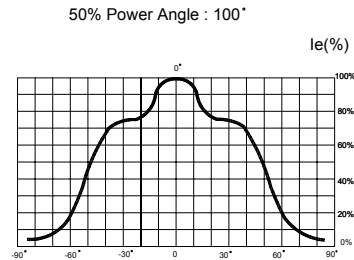

FIG.6 FAR FIELD PATTERN

1. Cathode PAD Area (0.18 X 0.18 X 2inch²)
2. Height above nominal seating plane in inches(0.3inch)

Items	Signatures	Date	Revision History	
Prepared by	LiuZM	2004/11/11	DOC. No.	CHANGE DESCRIPTION
Checked by	AldosinLi	2004/11/11	02 11Nov04	VF add V8. Change Φ_v & λ_D form.
Approved by	David	2004/11/11		
ECN#	ECN-H20040261			

Data is subject to change without prior notice.

Copyright©2002 Cotco International Ltd.

Obsoletes Doc: A 01Jul03.