

# Compact high speed thick film thermal printhead (8dots / mm)

## KD2002-DG10A

Using its expertise in LSI technology, ROHM has developed new high density driver chips for use in the KD2002-DG10A. Capable of being employed for both thermal and thermal transfer printing, with a print speed of 250mm/s, the resulting printheads are the fastest in their class. The high-speed and high-density printing answers the needs of ATM, kiosk and ticket printing devices, which are increasingly being called upon to produce graphical output.

### ●Applications

Label printers  
Ticket printers  
POS printers  
ATM printers  
KIOSK printers  
Terminal printers

### ●Features

- 1) The use of a special partial glaze and the latest heating element structure, along with new high-density driver chips that can accept big current, has allowed ROHM to achieve print speeds of 250mm/s, the fastest in its class.
- 2) One rank resistance value of  $650\Omega \pm 3\%$  eliminates the inconvenience of rank selection.
- 3) The required driving voltage of 3.15 to 5.25V allows wide range of power supply voltage setting. This also allows multiple choice of electronic components for printers.
- 4) 2-inch, 3-inch and 4-inch series are available.

### ●External dimensions (Unit : mm)

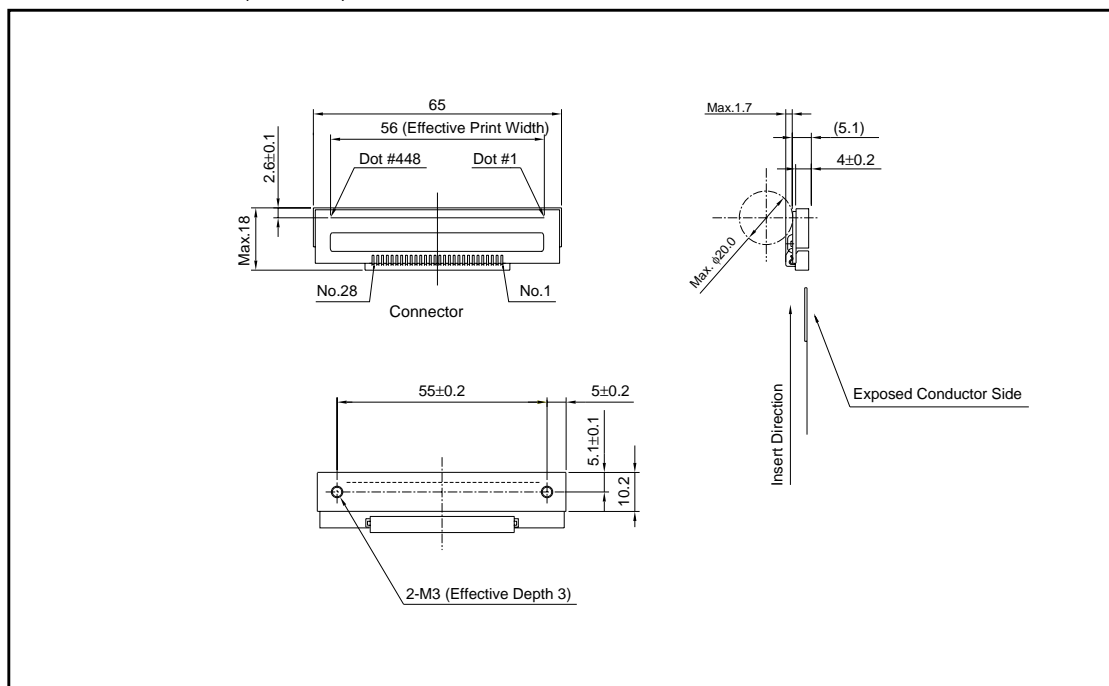

Printheads

●Equivalent circuit

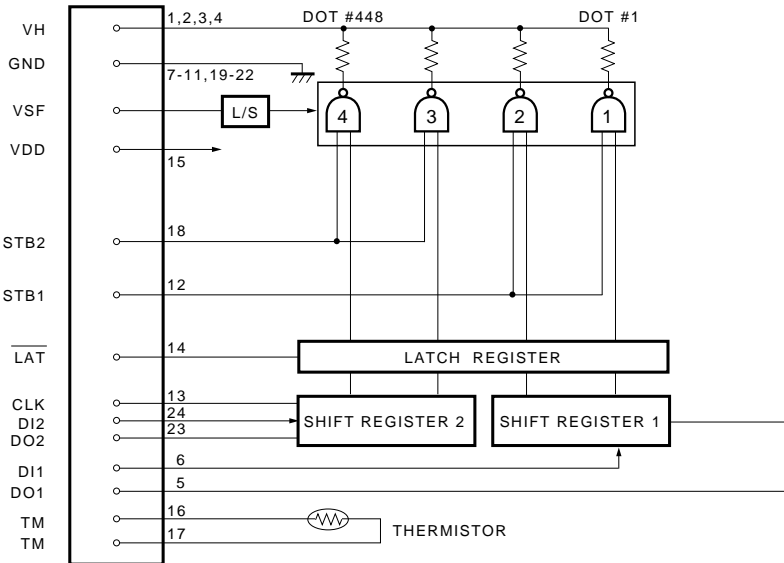

Fig.1

●Pin assignments

No.	Circuit	No.	Circuit
1	VH	15	V <sub>DD</sub>
2	VH	16	TM
3	VH	17	TM
4	VH	18	STB2
5	DO1	19	GND
6	DI1	20	GND
7	GND	21	GND
8	GND	22	GND
9	GND	23	DO2
10	GND	24	DI2
11	GND	25	VSF
12	STB1	26	VH
13	CLK	27	VH
14	LAT	28	VH

Printheads

●Timing chart

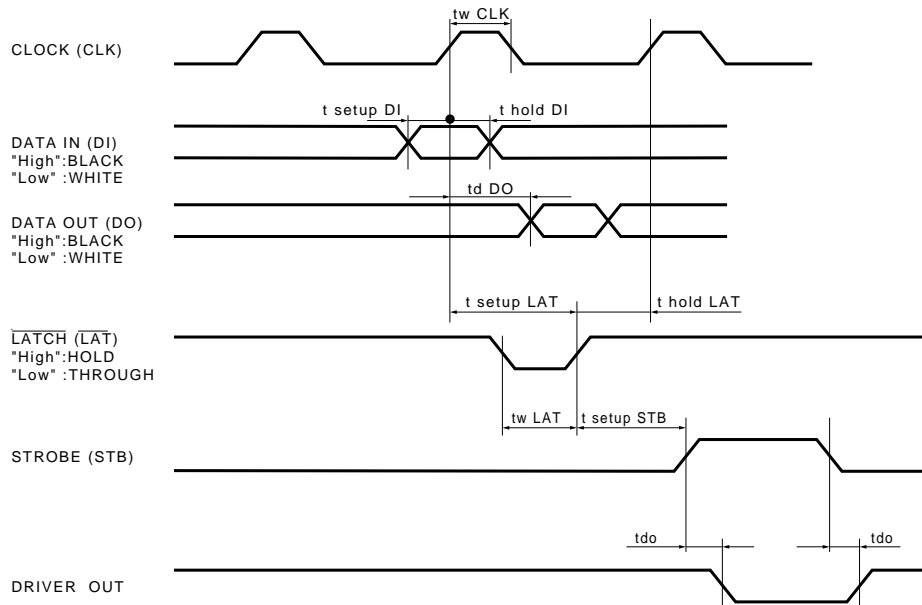

Fig.2

●Characteristics

Parameter	Symbol	Typical	Unit
Effective printing width	—	56.0	mm
Dot pitch	—	0.125	mm
Total dot number	—	448	dots
Average resistance value	Rave	650	$\Omega$
Applied voltage	$V_H$	24	V
Applied power	$P_O$	0.79	W/dot
Print cycle	SLT	0.5	ms
Pulse width	$T_{ON}$	0.19	ms
Maximum number of dots energized simultaneously	—	448	dots
Maximum clock frequency	—	16	MHz
Maximum roller diameter	—	$\phi 20.0$	mm
Running life / pulse life	—	$50/5 \times 10^7$	km/pulses
Operating temperature	—	5 to 45	$^{\circ}\text{C}$

Printheads

●Electrical characteristic curves

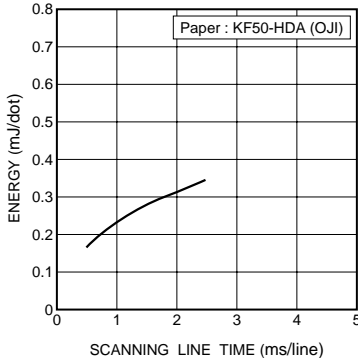

Fig.3 Adaptive speed chart

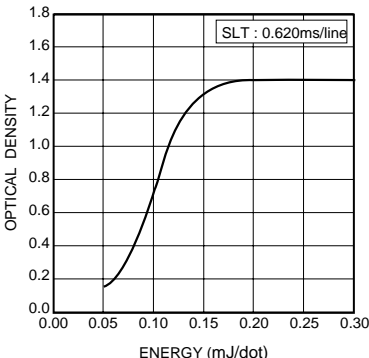

Fig.4 Representative density curve

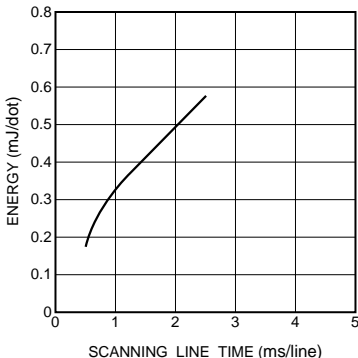

Fig.5 Maximum energy curve

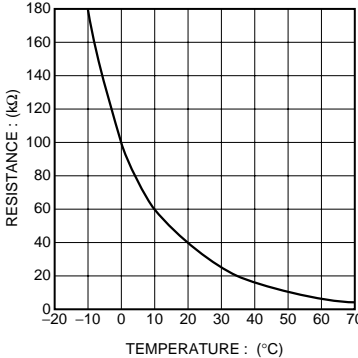

Fig.6 Thermistor curve

### Notes

- No technical content pages of this document may be reproduced in any form or transmitted by any means without prior permission of ROHM CO.,LTD.
- The contents described herein are subject to change without notice. The specifications for the product described in this document are for reference only. Upon actual use, therefore, please request that specifications to be separately delivered.
- Application circuit diagrams and circuit constants contained herein are shown as examples of standard use and operation. Please pay careful attention to the peripheral conditions when designing circuits and deciding upon circuit constants in the set.
- Any data, including, but not limited to application circuit diagrams information, described herein are intended only as illustrations of such devices and not as the specifications for such devices. ROHM CO.,LTD. disclaims any warranty that any use of such devices shall be free from infringement of any third party's intellectual property rights or other proprietary rights, and further, assumes no liability of whatsoever nature in the event of any such infringement, or arising from or connected with or related to the use of such devices.
- Upon the sale of any such devices, other than for buyer's right to use such devices itself, resell or otherwise dispose of the same, no express or implied right or license to practice or commercially exploit any intellectual property rights or other proprietary rights owned or controlled by
- ROHM CO., LTD. is granted to any such buyer.
- Products listed in this document are no antiradiation design.

The products listed in this document are designed to be used with ordinary electronic equipment or devices (such as audio visual equipment, office-automation equipment, communications devices, electrical appliances and electronic toys).

Should you intend to use these products with equipment or devices which require an extremely high level of reliability and the malfunction of which would directly endanger human life (such as medical instruments, transportation equipment, aerospace machinery, nuclear-reactor controllers, fuel controllers and other safety devices), please be sure to consult with our sales representative in advance.

#### About Export Control Order in Japan

Products described herein are the objects of controlled goods in Annex 1 (Item 16) of Export Trade Control Order in Japan.

In case of export from Japan, please confirm if it applies to "objective" criteria or an "informed" (by MITI clause) on the basis of "catch all controls for Non-Proliferation of Weapons of Mass Destruction.