



BRIDGED RB-TA3020-1, BRIDGED RB-TA3020-2, BRIDGED RB-TA3020-3

CLASS-T DIGITAL AUDIO AMPLIFIER EVALUATION BOARD

USING DIGITAL POWER PROCESSING (DPP™) TECHNOLOGY

Technical Information-Preliminary

Revision 1.0 - June 2001

GENERAL DESCRIPTION

The Bridged RB-TA3020 evaluation board is based on the TA3020 digital audio power amplifier from Tripath Technology. This board is designed to provide a simple and straightforward environment for the evaluation of the Tripath TA3020 amplifier in bridged mode. This board is implemented in a bridged configuration for high power mono output.

Note: There are three versions of the Bridged RB-TA3020, depending on nominal supply voltage and desired output power.

Bridged RB-TA3020-1 – Nominal supply voltage +/-23V to +/-36V

Bridged RB-TA3020-2 – Nominal supply voltage +/-30V to +/-48V

Bridged RB-TA3020-3 – Nominal supply voltage +/-40V to +/-64V

FEATURES

- Bridged RB-TA3020-1: 300W continuous output power @ 0.1% THD+N, 4Ω, ±30V
- Bridged RB-TA3020-2: 600W continuous output power @ 0.1% THD+N, 4Ω, ±43V
- Bridged RB-TA3020-3: 1200W continuous output power @ 0.1% THD+N, 4Ω, ±60V
- Outputs short circuit protected

BENEFITS

- Quick, easy evaluation and testing of the TA3020 amplifier in bridged mode
- Uses only N-channel power MOSFETs
- Ready to use in many applications:
 - Car Audio Amplifier
 - Powered Subwoofers
 - High Power Mono Amplifier

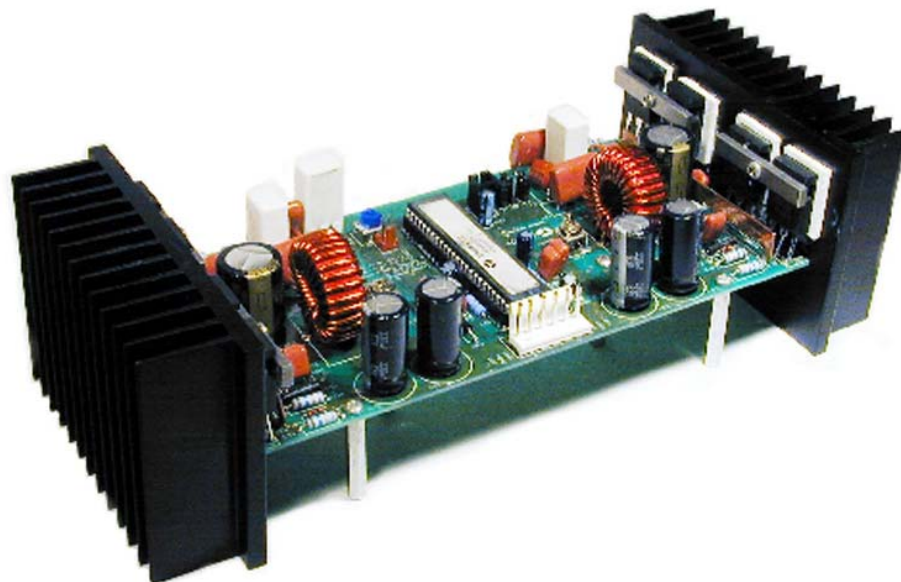

OPERATING INSTRUCTIONS

Power Supply Description

There are four external power supplies required to operate this board: VPP, VNN, VN10, and V5 (see Figures 1 and 2). VPP and VNN power the load and so must each be able to provide half of the desired output power, plus about 20% for overhead and margin. The TA3020 amplifier also requires a supply, VN10, that is 10V more positive than VNN and tracks VNN.

Though not required, the following powering-up sequence is usually adhered to during bench evaluations: 1st) V5 and VN10, 2nd) VNN and 3rd) VPP (refer to the Turn-on/off Pop section). The positive and negative supply voltages do not have to match or track each other, but distortion or clipping levels will be determined by the lowest (absolute) supply voltage. Figure 1 shows the proper supply configuration for the EB-TA3020.

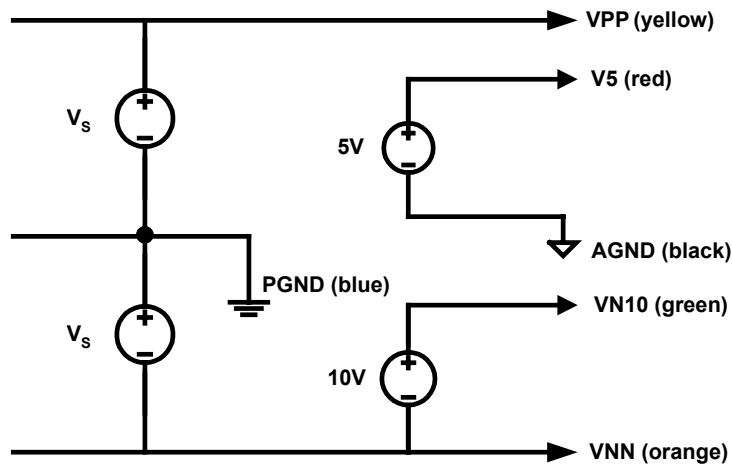

Note: To avoid signal degradation, the Analog Ground and Power Ground should be kept separate at the power supply. They are connected locally on the Bridged RB-TA3020-X. The two VPP yellow wires should be tied together and the two VNN orange wires should also be tied together.

Connector	Power Supply
J2 (Yellow)	VPP
J2 (Blue)	PGND
J2 (Orange)	VNN
J2 (Orange)	VNN
J2 (Green)	VN10
J2 (Yellow)	VPP
J1 (Red)	V5
J1 (Black)	AGND

Table 1

Input Connections

Audio input to the board is located at INPUT (J200) (see Figures 2 and 3). The input can be a test signal or music source. An RCA cable is provided with a female 100mil connector to mate with J200.

Output Connections

There are two output connectors on the reference board for the speaker output. The positive output is connected to J101 with a red wire attached. The negative output is connected to J202 with a black wire attached. The negative output is not a ground, but an output signal with equal amplitude and opposite phase compared to the positive output. Outputs can be any passive speaker(s) or test measurement equipment with resistive load (see Application Note 4 for more information on bench testing).

Turn-on/off Pop

To avoid turn-on pops, bring the mute from a high to a low state after all power supplies have settled. To avoid turn-off pops, bring the mute from a low to a high state before turning off the supplies. The only issue with bringing up the V5 last, or turning it off first, is clicks/pops. If the mute line is properly toggled (slow turn-on, quick turn-off), then any power up sequence is acceptable. In practice, the V5 will usually collapse before VPP and VNN. The same holds true for the VN10 supply. It can collapse before VPP or VNN though this may cause a larger turn-off pop than if the mute had been activated before either the VN10 or V5 supply have collapsed. No damage will occur to the TA3020 if either the V5 or VN10 collapse before VPP or VNN.

EB-TA3020 BOARD

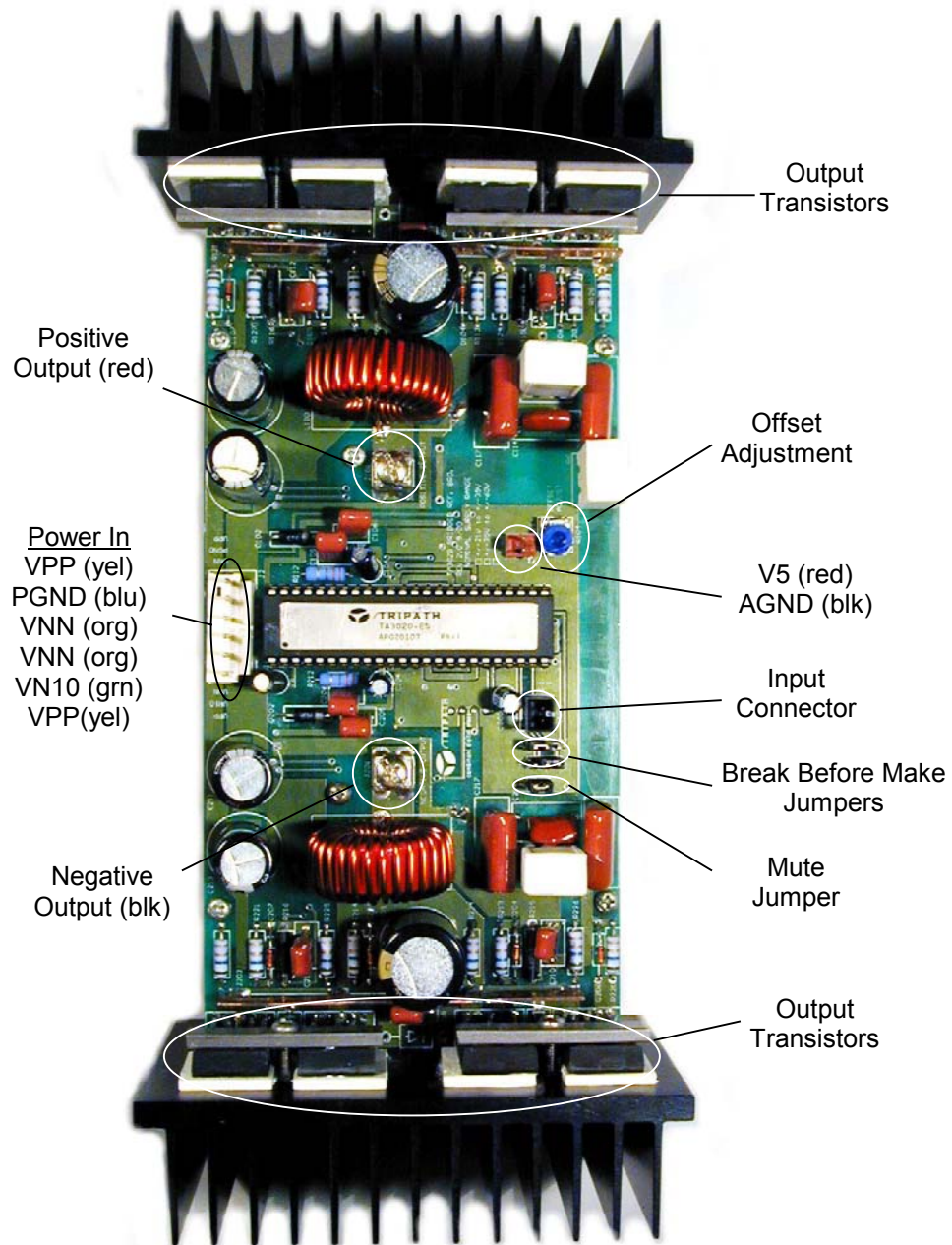

Figure 2

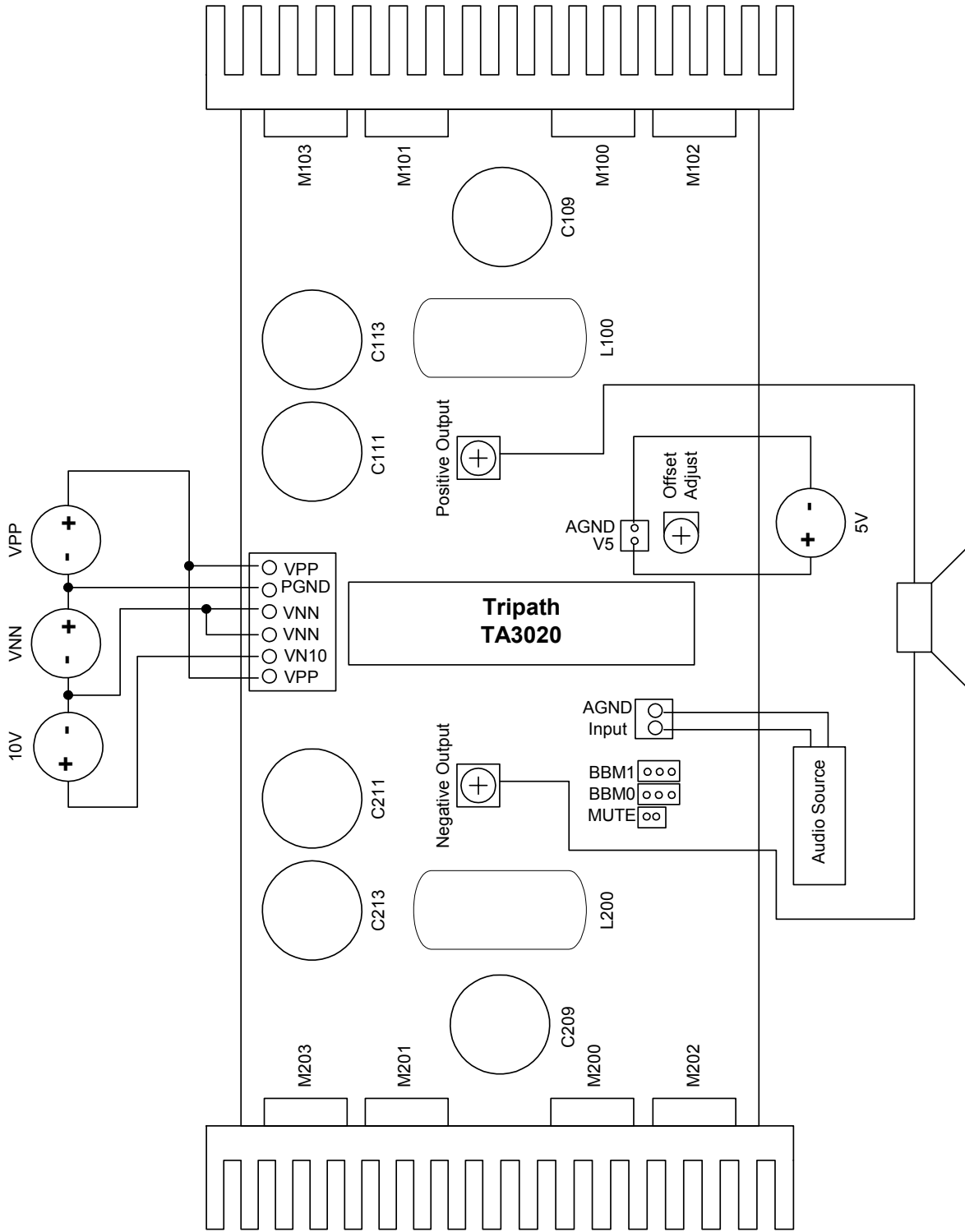

Figure 3

ELECTRICAL CHARACTERISTICS FOR BRIDGED RB-TA3020-1

Unless otherwise specified, $f = 1\text{kHz}$, Measurement Bandwidth = 22kHz, $R_L = 4\Omega$, $T_A = 25\text{ }^\circ\text{C}$. All of the measurements are typical value.

SYMBOL	PARAMETER	CONDITIONS	VALUE
P_O	Output Power (Continuous Average/bridged load) Bridged RB-TA3020-1 +/-30V power supplies	THD+N = 0.1% $R_L = 4\Omega$	350W
		THD+N = 10% $R_L = 2\Omega$	600W
		$R_L = 4\Omega$	500W
		$R_L = 2\Omega$	850W
+Freq _{sw}	Switching Frequency of the Positive Output	$V_{IN} = 0\text{ V}$	650kHz
-Freq _{sw}	Switching Frequency of the Negative Output	$V_{IN} = 0\text{ V}$	620kHz
VN10I _q	Quiescent Current of VN10 supply	$V_{IN} = 0\text{ V}$	180mA
V5I _q	Quiescent Current of V5 supply	$V_{IN} = 0\text{ V}$	45mA
VPPI _q	Quiescent Current of VPP supply	$V_{IN} = 0\text{ V}$	100mA
VNNI _q	Quiescent Current of VNN supply	$V_{IN} = 0\text{ V}$	100mA
η	Power Efficiency	+/- 30V, $P_{OUT} = 500\text{W}$, $R_L = 4\Omega$	89%
η	Power Efficiency	+/- 30V, $P_{OUT} = 850\text{W}$, $R_L = 2\Omega$	83%
e _{OUT}	Output Noise Voltage	A-Weighted, input AC grounded	215uV

ELECTRICAL CHARACTERISTICS FOR BRIDGED RB-TA3020-2

Unless otherwise specified, $f = 1\text{kHz}$, Measurement Bandwidth = 22kHz, $R_L = 4\Omega$, $T_A = 25\text{ }^\circ\text{C}$. All of the measurements are typical value.

SYMBOL	PARAMETER	CONDITIONS	VALUE
P_O	Output Power (Continuous Average/bridged load) Bridged RB-TA3020-2 +/-43V power supplies	THD+N = 0.1% $R_L = 4\Omega$	710W
		THD+N = 10% $R_L = 2\Omega$	950W
		$R_L = 4\Omega$	1000W
P_O	Output Power (Continuous Average/bridged load) Bridged RB-TA3020-2 +/-33V power supplies	THD+N = 0.1% $R_L = 2\Omega$	650W
		THD+N = 10% $R_L = 2\Omega$	900W
+Freq _{sw}	Switching Frequency of the Positive Output	$V_{IN} = 0\text{ V}$	640kHz
-Freq _{sw}	Switching Frequency of the Negative Output	$V_{IN} = 0\text{ V}$	605kHz
VN10I _q	Quiescent Current of VN10 supply	$V_{IN} = 0\text{ V}$	270mA
V5I _q	Quiescent Current of V5 supply	$V_{IN} = 0\text{ V}$	45mA
VPPI _q	Quiescent Current of VPP supply	$V_{IN} = 0\text{ V}$ VPP = +43V VNN = -43V	110mA
VNNI _q	Quiescent Current of VNN supply	$V_{IN} = 0\text{ V}$ VPP = +43V VNN = -43V	110mA
η	Power Efficiency	+/- 43V, $P_{OUT} = 1000\text{W}$, $R_L = 4\Omega$	88%
η	Power Efficiency	+/- 33V, $P_{OUT} = 900\text{W}$, $R_L = 2\Omega$	83%
e _{OUT}	Output Noise Voltage	A-Weighted, input AC grounded	300uV

ELECTRICAL CHARACTERISTICS FOR BRIDGED RB-TA3020-3

Unless otherwise specified, $f = 1\text{kHz}$, Measurement Bandwidth = 22kHz, $R_L = 4\Omega$, $T_A = 25\text{ }^\circ\text{C}$.
All of the measurements are typical value.

SYMBOL	PARAMETER	CONDITIONS	VALUE
P_O	Output Power (Continuous Average/bridged load) Bridged RB-TA3020-3 +/-60V power supplies	THD+N = 0.1% $R_L = 4\Omega$ THD+N = 10% $R_L = 4\Omega$	1350W 1800W
P_O	Output Power (Continuous Average/bridged load) Bridged RB-TA3020-3 +/-43V power supplies	THD+N = 0.1% $R_L = 2\Omega$ THD+N = 10% $R_L = 2\Omega$	1350W 1500W
+Freq _{sw}	Switching Frequency of the Positive Output	$V_{IN} = 0\text{ V}$	630kHz
-Freq _{sw}	Switching Frequency of the Negative Output	$V_{IN} = 0\text{ V}$	600kHz
VN10I _q	Quiescent Current of VN10 supply	$V_{IN} = 0\text{ V}$	290mA
V5I _q	Quiescent Current of V5 supply	$V_{IN} = 0\text{ V}$	45mA
VPPI _q	Quiescent Current of VPP supply	$V_{IN} = 0\text{ V}$ VPP = +60V VNN = -60V	130mA
VNNI _q	Quiescent Current of VNN supply	$V_{IN} = 0\text{ V}$ VPP = +60V VNN = -60V	140mA
η	Power Efficiency	+/- 60V, P _{OUT} = 1800W, $R_L = 4\Omega$	87%
η	Power Efficiency	+/- 43V, P _{OUT} = 1200W, $R_L = 2\Omega$	84%
e _{OUT}	Output Noise Voltage	A-Weighted, input AC grounded	400uV

TYPICAL PERFORMANCE FOR BRIDGED RB-TA3020-1

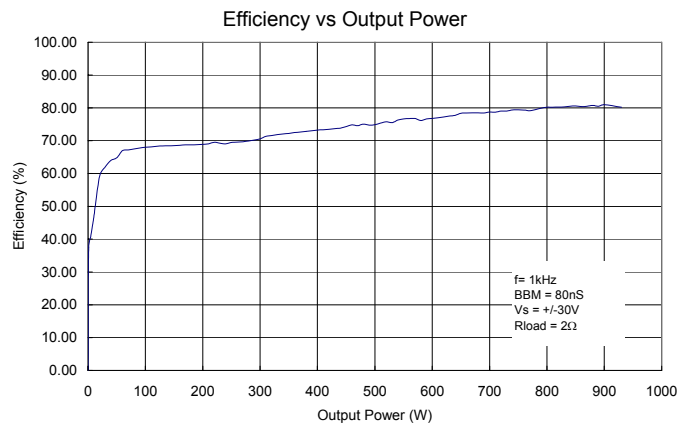
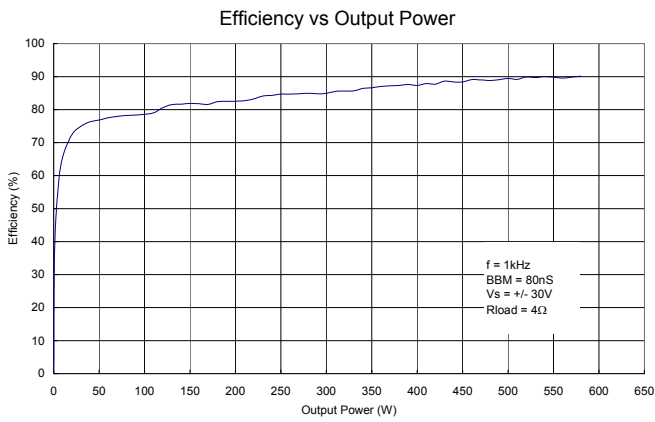
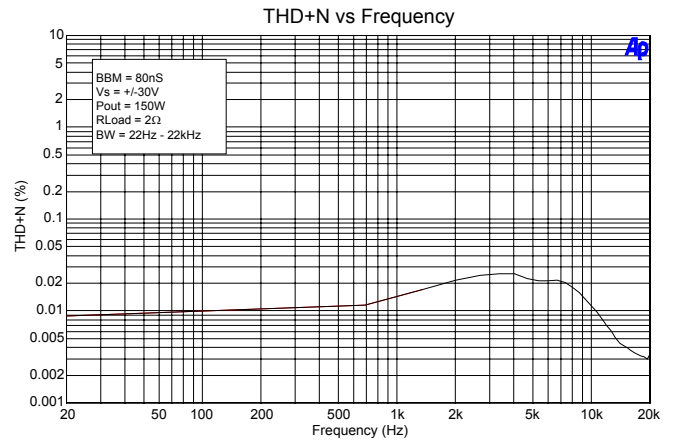
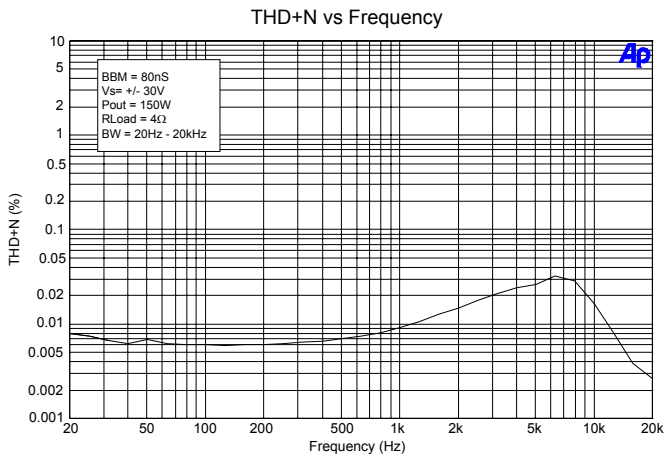
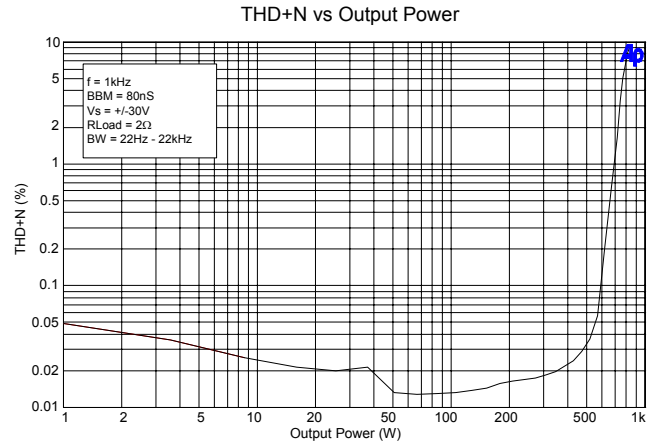
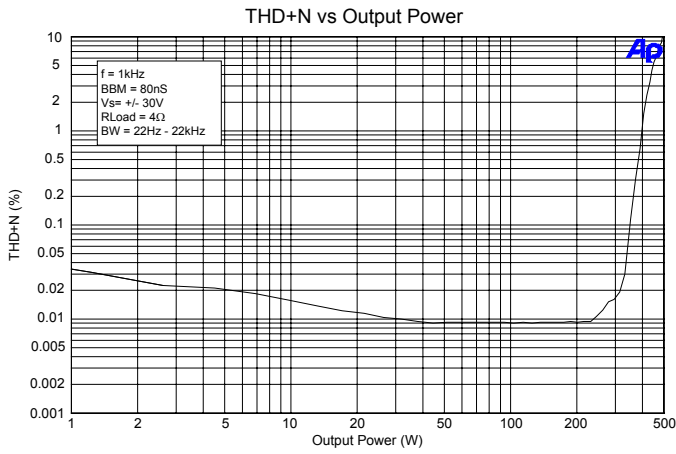

TYPICAL PERFORMANCE FOR BRIDGED RB-TA3020-2

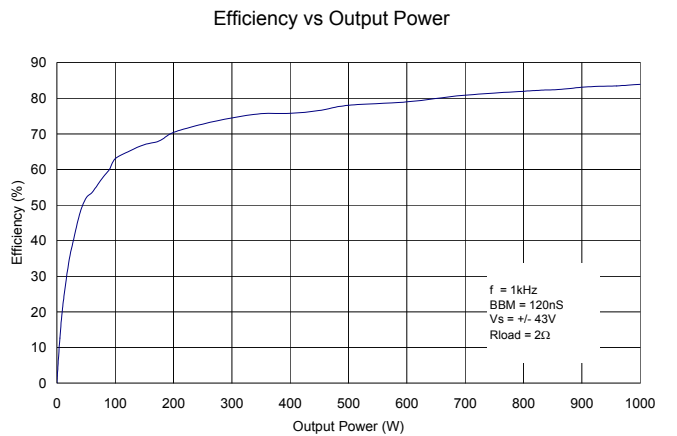
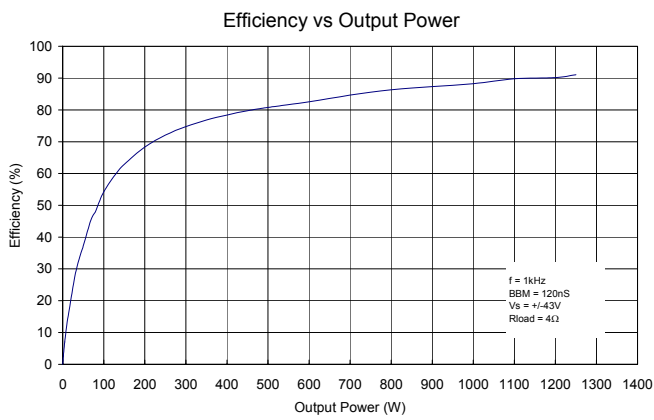
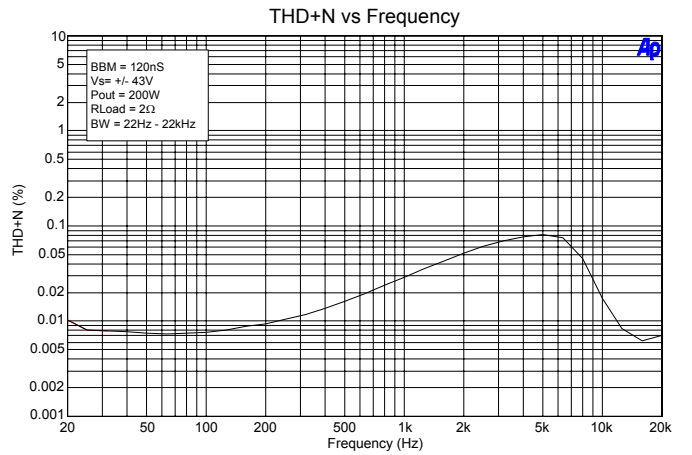
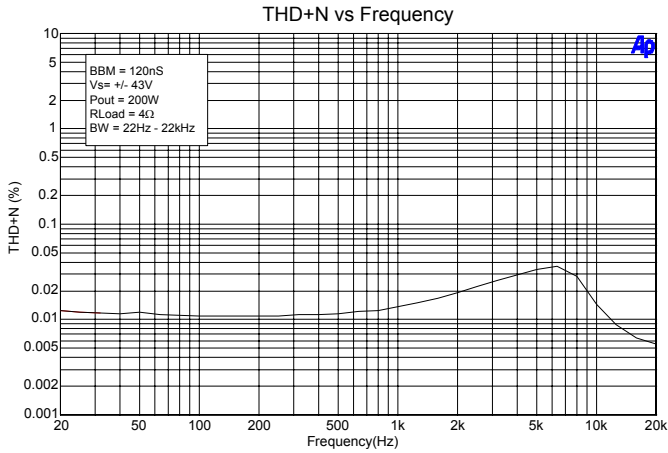
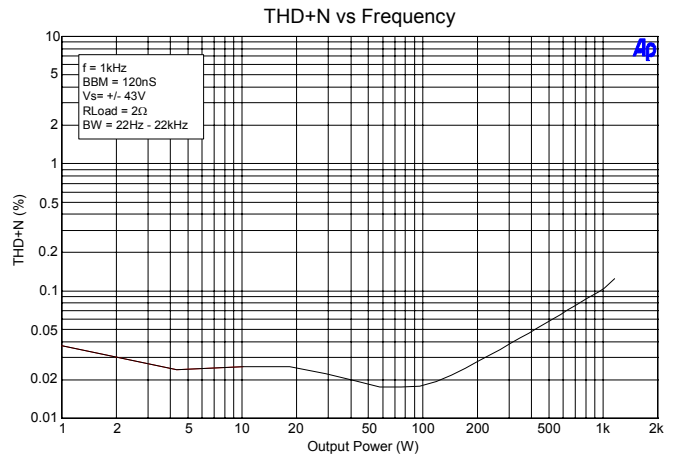
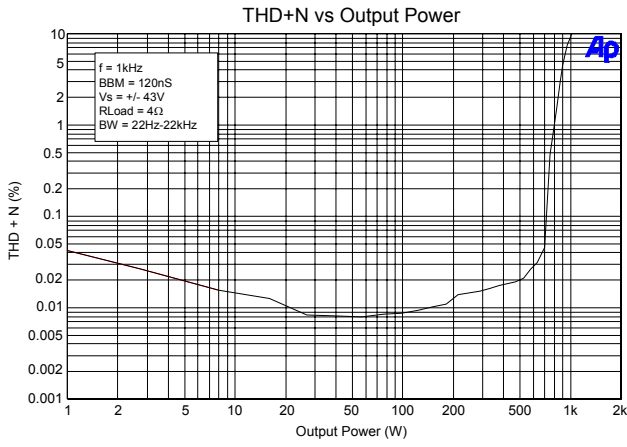

TYPICAL PERFORMANCE FOR BRIDGED RB-TA3020-2

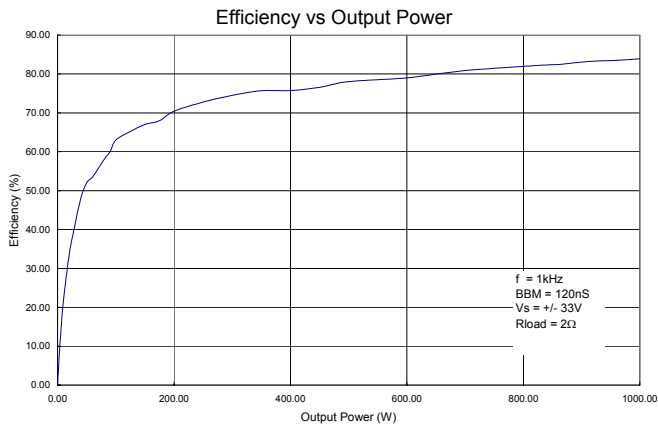
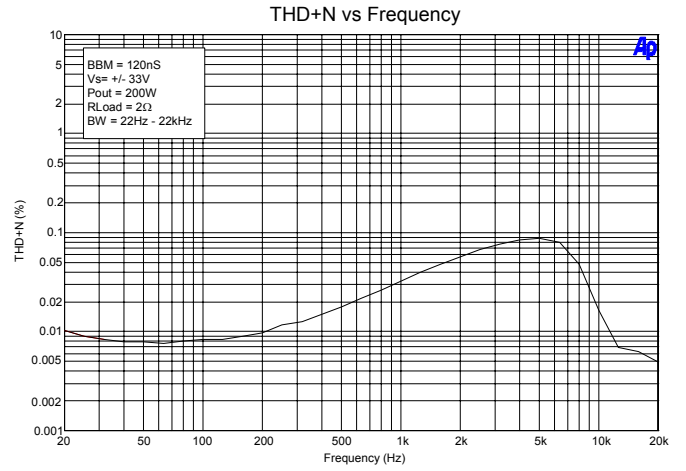
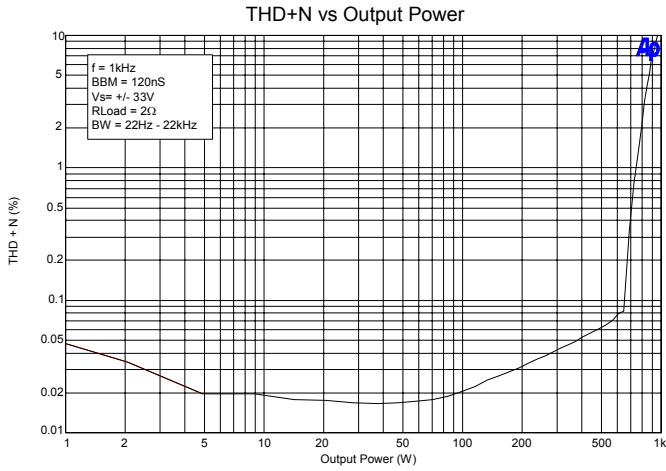

TYPICAL PERFORMANCE FOR BRIDGED RB-TA3020-3

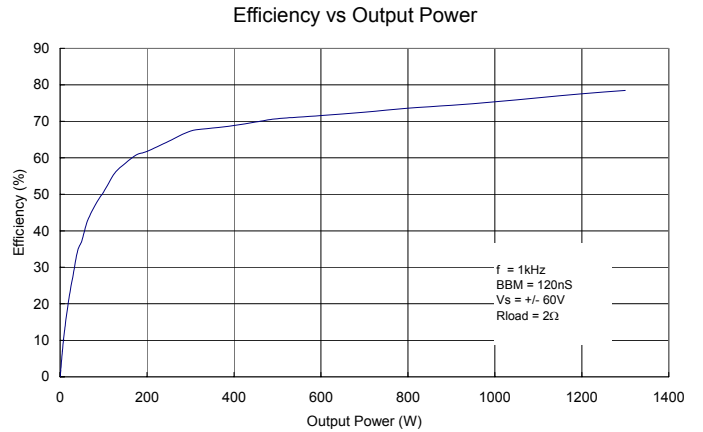
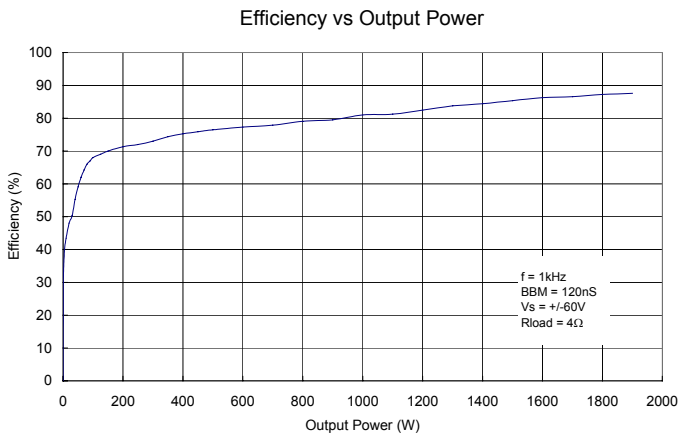
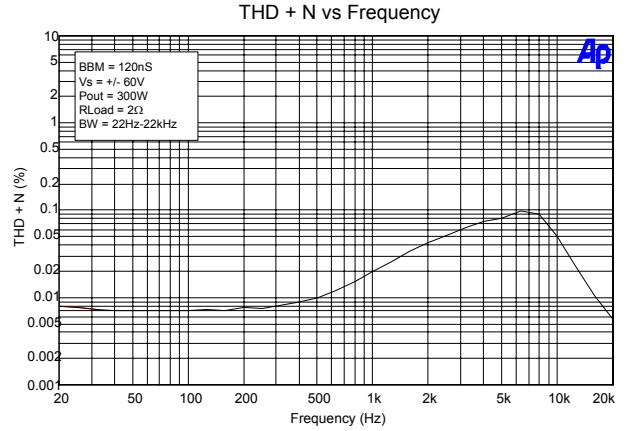
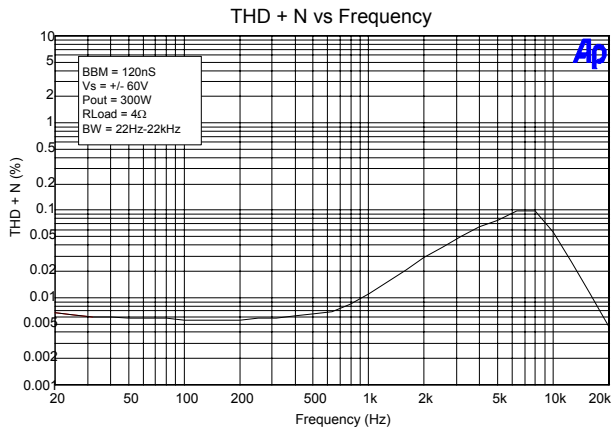
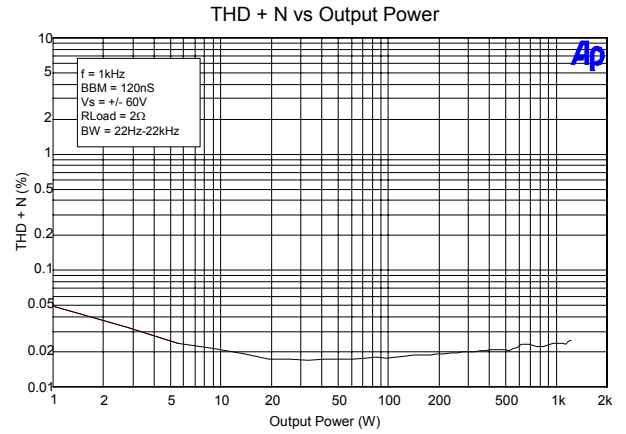
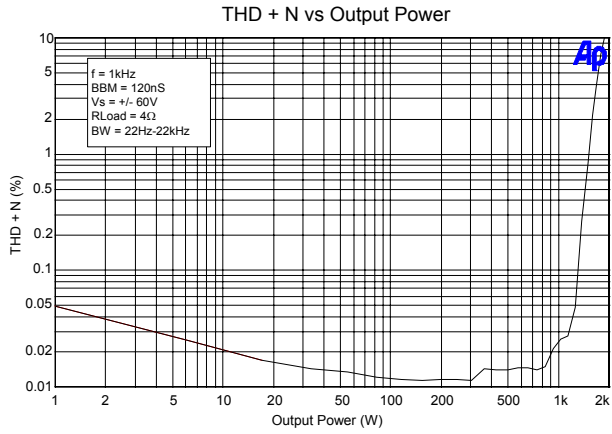

TYPICAL PERFORMANCE FOR BRIDGED RB-TA3020-3

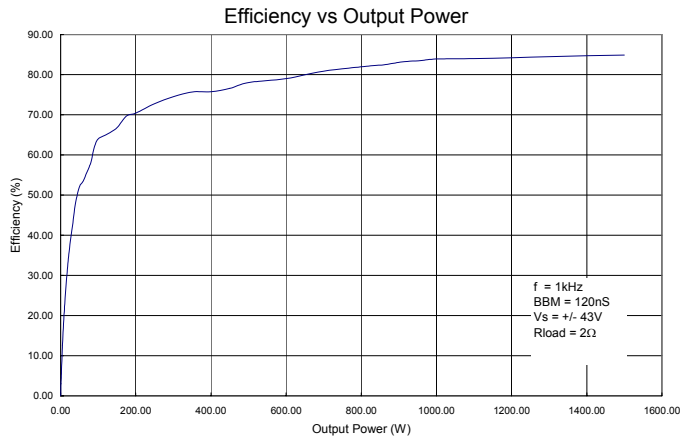
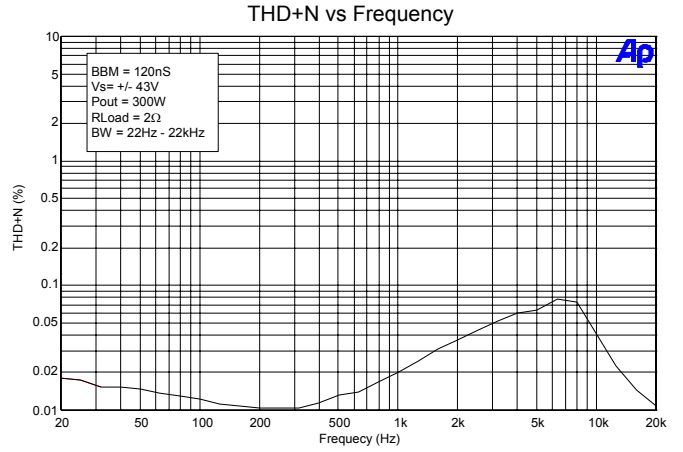
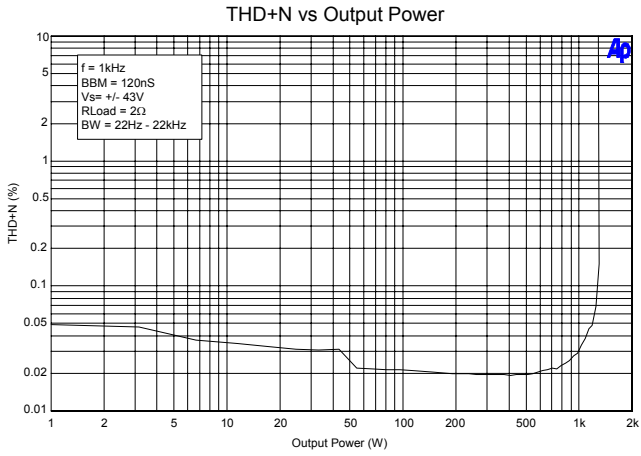

Safe Operating Areas

The TA3020 must always remain in the safe operating area in order to ensure a robust and reliable design. The Bridged RB-TA3020-X boards have been optimized for 4Ω and 2Ω load applications. All three of the Bridged RB-TA3020-X boards have been designed to be 1Ω stable, however the current limit has been set by the OCR resistors (R111 and R211) to not allow the output to achieve maximum power in order to remain in the safe operating area. If a 1Ω load is connected to the output, the amplifier will continue to function but will go into an overcurrent mode when driving a presumable amount of power. For the Bridged RB-TA3020-1 board with a 1Ω load connected to the output, the amplifier will enter the overcurrent mode and shutoff at approximately 500W. For the Bridged RB-TA3020-2 board with a 1Ω load connected to the output, the amplifier will enter the overcurrent mode and shutoff at approximately 800W. For the Bridged RB-TA3020-3 board with a 1Ω load connected to the output, the amplifier will enter the overcurrent mode and shutoff at approximately 675W. To reset the amplifier after an overcurrent condition, the mute pin (pin 24) must be toggled or the power supplies must be cycled off and on to enable the amplifier.

The Bridged RB-TA3020-1 is optimized for a +/-30V power supply and will function from a minimum of +/-23V to a maximum of +/-36V. At +/-30V the Bridged RB-TA3020-1 will sufficiently drive a 4Ω and 2Ω load as shown in the Typical Performance graphs.

The Bridged RB-TA3020-2 is optimized for a +/-43V power supply and will function from a minimum of +/-30V to a maximum of +/-48V. At +/-43V the Bridged RB-TA3020-2 will sufficiently drive a 4Ω and 2Ω load as shown in the Typical Performance graphs. However with 2Ω load conditions the amplifier will shutdown if pushed beyond 1200W. In order for the amplifier to achieve the full output signal swing, the power supply must be reduced to +/- 33V. This will allow the amplifier to achieve 950W at 10% THD+N with a 2Ω load.

The Bridged RB-TA3020-3 is optimized for a +/-60V power supply and will function from a minimum of +/-40V to a maximum of +/-64V. At +/-60V the Bridged RB-TA3020-3 will sufficiently drive a 4Ω and 2Ω load as shown in the Typical Performance graphs. However, with a 2Ω load, the amplifier will shutdown if pushed beyond 1500W. In order for the amplifier to achieve the full output signal swing, the power supply must be reduced to +/- 43V. This will allow the amplifier to achieve 1500W at 10% THD+N with a 2Ω load.

These limitations placed on the amplifier are to ensure the system will remain in the safe operating area. Changing the values of the OCR resistors (R211 and R111) will change the overcurrent trip point and thus increase or reduce output power. It is not recommended to increase the overcurrent trip point to increase the output power, otherwise reliability will be reduced in the system. For formulas on how to set the overcurrent trip point, please refer to the TA3020 datasheet.

The safe operating area is dependent upon the power dissipation, the operating ambient temperature and the heatsinking. As an example, if the Bridged RB-TA3020-3 board is operating at +/-60V with a 2Ω load. At 400W the amplifier is 68% efficient and the eight output FETs will be dissipating approximately 133W. Each of the output FETs will be dissipating approximately 17W. To operate at an ambient temperature of 20°C, the heatsink needs to be able to keep the output FETS below the maximum junction temperature of 150°C.

(Maximum Junction Temperature for Output FETs – ambient temperature)/Power dissipated = θ_{JA} of the heatsink

$$150^{\circ}\text{C} - 20^{\circ}\text{C} = 130^{\circ}\text{C}$$

$$130^{\circ}\text{C} / 133\text{W} = 0.98^{\circ}\text{C/W}$$

In order to run the amplifier at 400W into a 2Ω load continuously at 20°C for an infinite amount of time, a θ_{JA} of 0.98°C/W heatsink is required.

In an application such as a car audio trunk mounted amplifier, where the ambient temperature can run up to 85°C:

$$150^{\circ}\text{C} - 85^{\circ}\text{C} = 65^{\circ}\text{C}$$

$$65^{\circ}\text{C} / 133\text{W} = 0.49^{\circ}\text{C/W}$$

A θ_{JA} of 0.49°C/W heatsink is required in order to operate the amplifier at 400W into a 2Ω load continuously at 85°C for an infinite amount of time.

The θ_{JA} of every heatsink indicates the thermal properties for an infinite amount of time, therefore a characterization of each heatsink should be done to plot the θ_{JA} vs time. This will provide information for the heatsink characteristics for power dissipation capabilities for a given finite amount of time.

A system fan can be used to help increase the efficiency of the heatsink. Additional FETs cannot be added to the RB-TA3020-2 and RBTA3020-3 boards to help the power dissipation because the TA3020 cannot reliably drive more than 150nC.

ARCHITECTURE

A block diagram of the evaluation board is shown in Figure 4. The major functional blocks of the amplifier are described below.

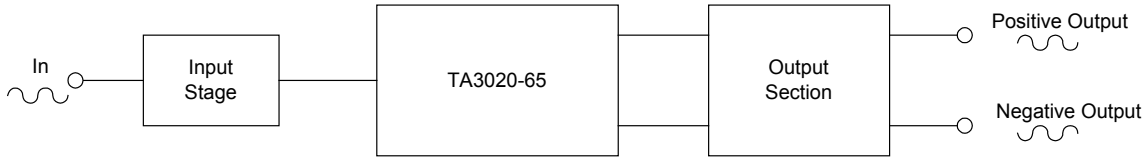

Figure 4

Note: The negative output is identical to the positive output with 180 degrees phase shift.

Input Stage

Figure 5 shows Input Stage before the TA3020. The TA3020 amplifier is designed to accept unbalanced inputs. For the Bridged RB-TA3020-1, the gain is 12.2 V/V differentially, or approximately 22 dB. For the Bridged RB-TA3020-2, the gain is 16.8 V/V differentially, or approximately 24.5 dB. For the Bridged RB-TA3020-3, the gain is 23.8 V/V differentially, or approximately 27.5 dB. Please note that the input stage of the TA3020 is biased at approximately 2.5VDC. For an input signal centered at ground (0VDC), the polarity of the coupling capacitor, C_{IN} , shown in Figure 5 is correct.

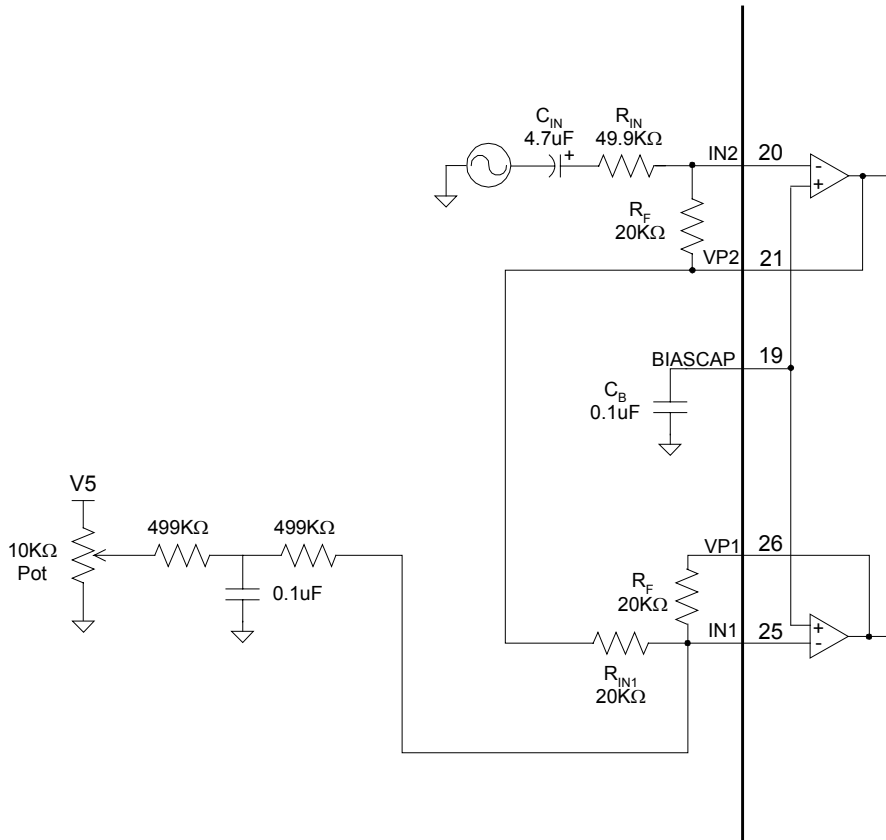

Figure 5

The audio signal is input through pin 20 and fed through an inverting op amp. The output of this op amp (pin 21) is tied to the input a unity gain inverting op amp. This configuration of cascading two inverting op amps results in two input signals to the amplifier of equal amplitude and 180 degrees phase shift without the need of an external op amp.

The value of the input capacitor, C_{IN} , in Figure 5 (labeled C200 on the schematic), and the input resistor, R_{IN} (labeled R200 on the schematic), sets the $-3dB$ point of the input high-pass filter. The frequency of the input high pass pole, F_{3dB} , $-3dB$ point can be calculated as follows:

$$F_{3dB} = 1/(2\pi \times C_{IN} \times R_{IN})$$

where: C_{IN} = input capacitor value in Farads
 R_{IN} = input resistor value in Ohms

Output offset voltages can be nulled by adjusting the 10k Ω potentiometer shown in Figure 5. Once set, the offset does not typically drift with temperature, so no tracking circuitry is required. Offsets can typically be set to ± 25 mV. The output offset is trimmed differentially across the positive and negative outputs, thus only one channel needs the offset trimmed. If a different TA3020 is placed in the Bridged RB-TA3020 evaluation board, the offset would need to be re-trimmed.

EB-TA3020 Control Circuitry

The MUTE pin is brought out to an external 2-pin header, J3 (Figure 6). When a jumper is installed from Pin 1 to 2 of J3, the MUTE line is pulled to ground and the outputs are enabled. Note that if the MUTE jumper is removed, the MUTE pin floats high, and the amplifier is muted.

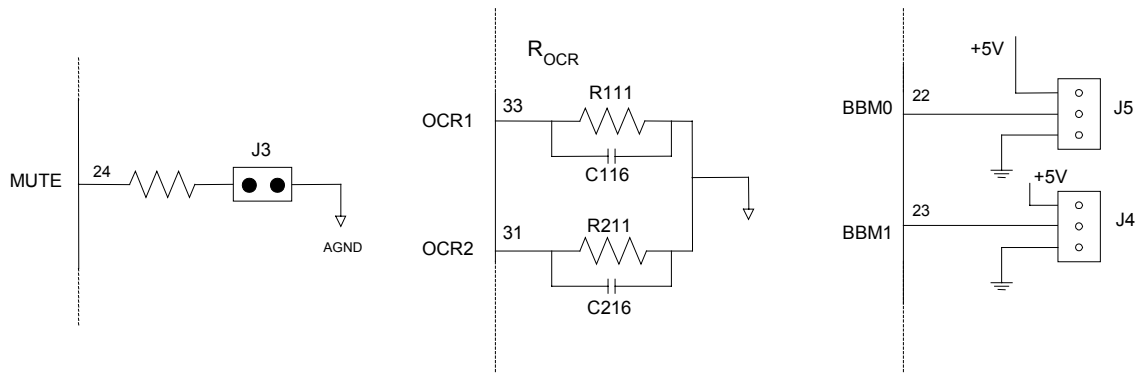

Figure 6

The resistors, R_{OCR} in Figure 6 (labeled R111 and R211 in the schematic), set the overcurrent threshold for the output devices. Note that these are NOT the sense resistors (the overcurrent sense resistors, R_S , are in the output stage). By adjusting the R_{OCR} resistor values, the threshold at which the amplifier “trips” can be changed. The range that the overcurrent trip point can be adjusted (by changing R_{OCR}) is determined by the value of the sense resistors.

R_{OCR} on this evaluation board is pre-set for a 4 Ω and 2 Ω bridged load application. For lower impedance applications (i.e. 1 Ω bridged), this board’s overcurrent will trip. This is indicated by the amplifier going into mute and the HMUTE pin will latch to 5V; to clear this condition, toggle the mute or cycle the power. To reduce overcurrent sensitivity, decrease the value of R_{OCR} until the sensitivity meets the desired level. R_{OCR} can be reduced though this may result in an overcurrent threshold that is so high the amplifier will try to drive a short circuit, possibly damaging the output FETs.

Finally, the Break-Before-Make (or “BBM”) lines are used to control the “dead time” of the output FETs. The “dead time” is the period of time between the turn-off of one device and the turn-on of the opposite device on the same channel. If the two devices are both on at the same time, current “shoots through” from one supply to the other, bypassing the load altogether. Obviously, this will have a great impact on the overall efficiency of the amplifier. However, if the dead time is

too long, linearity suffers. The optimum BBM setting will change with different output FETs, different operating voltages, different layouts and different performance requirements. For this reason, Tripath has provided a means to adjust the BBM setting among four preset levels by moving jumpers J2 and J3 on their 3-pin headers (see Figure 6).

These settings should be verified over the full temperature and load range of the application to ensure that any thermal rise of the output FETs and TA3020 does not impact the performance of the amplifier. The RB-TA3020-1 and RBTA3020-2 amplifier boards is set to 80nS and the RB-TA3020-3 is set to 120nS. The table below shows the BBM values for various settings of the jumpers (Figure 7).

	BBM1	BBM0	<u>Delay</u>
1)	0	0	120nS
2)	0	1	80nS
3)	1	0	40nS
4)	1	1	0nS

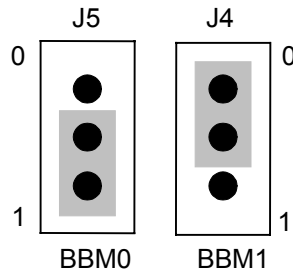

Note: The jumper setting shown is 80nS.

Figure 7

Auto Recovery Circuit for Overcurrent Fault Condition

If an overcurrent fault condition occurs the HMUTE pin (pin 15) will be latched high and the amplifier will be muted. The amplifier will remain muted until the MUTE pin (pin 24) is toggled high and then low or the power supplies are turned off and then on again. The circuit shown below in Figure 8 is a circuit that will detect if HMUTE is high and then toggle the mute pin high and then low, thus resetting the amplifier. The LED, D1 will turn on when HMUTE is high. The reset time has been set for approximately 2.5 seconds. The duration of the reset time is controlled by the RC time constant set by R306 and C311. To increase the reset, time increase the value of C311. To reduce the reset time, reduce the value of C311. Please note that this circuit is optional and in not included on the RB-TA3020-X boards.

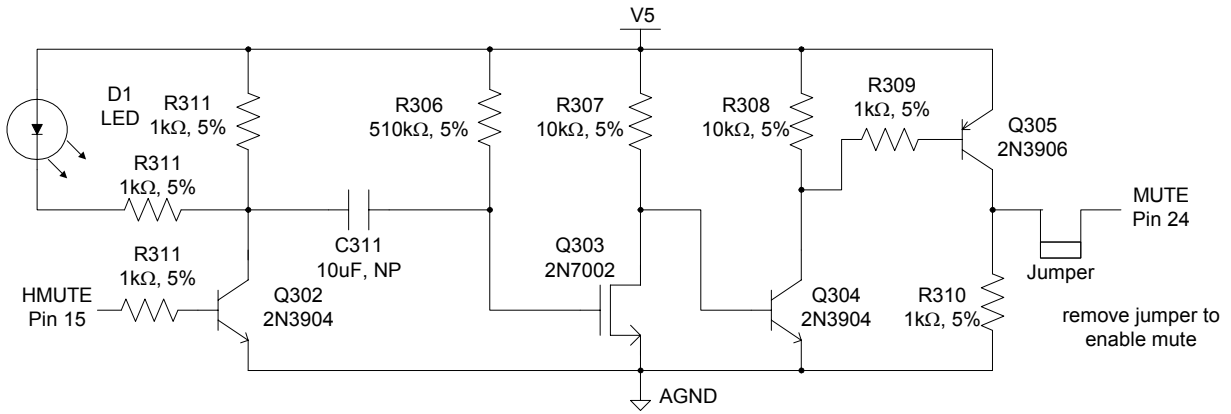

Figure 8

Output Section

The output section includes the gate resistors, gate diodes, source resistors, FETs, output filters, the previously mentioned overvoltage sense resistors, a Zobel Network, the common mode capacitor, the common mode zobel network and various bypass capacitors. Figure 8 below shows the output stage of the positive output of this amplifier. The negative output section will be symmetrical in terms of component values, component placements, and overall functionality.

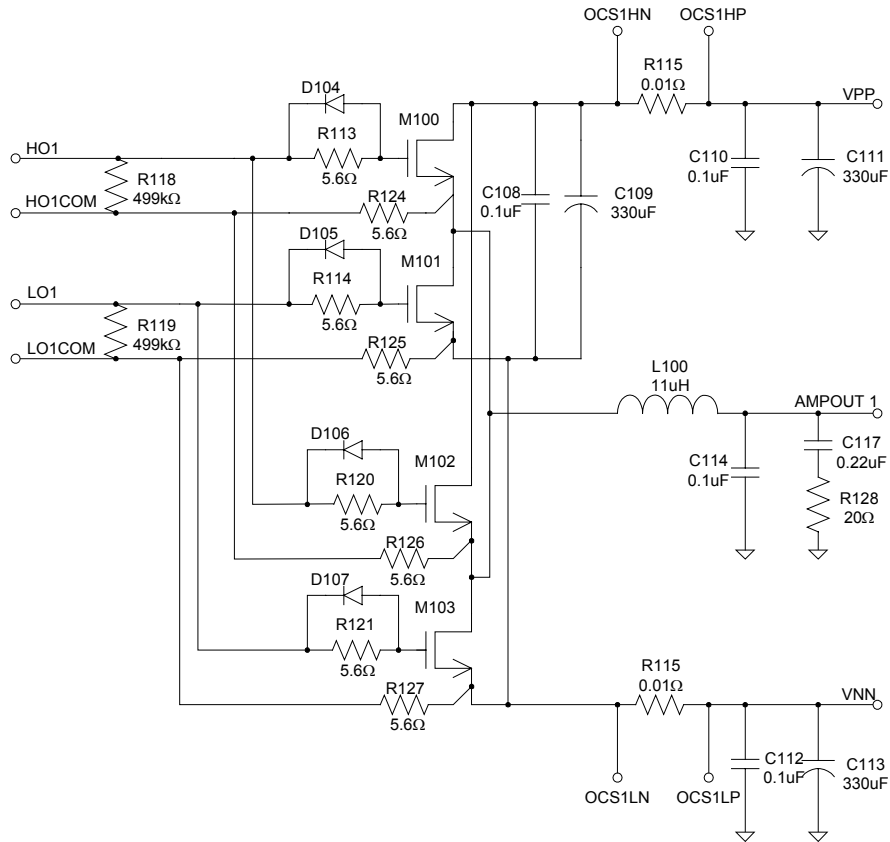

Figure 9

The gate resistors (labeled R113, R114, R120, and R121 in Figure 9 and the attached schematic) are used to control MOSFET switching rise/fall times and thereby minimize voltage overshoots. They also dissipate a portion of the power resulting from moving the gate charge each time the MOSFET is switched. If R_G is too small, excessive heat can be generated in the driver. Large gate resistors lead to slower gate transitions resulting in longer rise/fall times and thus requiring a larger BBM setting.

The gate diodes (D104, D105, D106, D107) are used to reduce the fall time at the gate of the output FETs. This allows us to use the 5.6Ω gate resistor, which increases the rise time of the gate, reduces switching noise at the output FETs and reduce the overall noise floor of the amplifier.

The source resistors (R124, R125, R126, R127) are recommended to protect the TA3020 from any overvoltage damage. The source resistors provide protection to the HO1COM and LO1COM pins due to the large overshoots and undershoots of the switching waveform that can occur at the output during high power operation.

R118 and R119 are gate pull down resistors to ensure the output FETs remain off if VPP and VNN are powered on and the TA3020 is not powered on. $499k\Omega$ is the ideal value for these resistors. Larger values of R118 and R119 can cause the gate of the output FETs to float and smaller values of R118 and R119 will affect the drive capabilities of the HO1 and LO1 pins.

The output FETs (M100, M101, M200 and M201) provide the switching function required of a Class-T design. They are driven directly by the TA3020 through the gate resistors. M100 and M102 are placed in parallel and provide the high side drive of the output stage. M101 and M103 are in parallel and provide the low side drive of the output stage. The FETs are required to be placed in parallel for the purposes of higher current handling capability and improved power dissipation. (Note: Bridged RBTA3020-1 does not have M101 and M103 and it's associated components because it has a lower power output) The devices used on the evaluation board are STW34NB20 MOSFETs. The TA3020 data sheet contains information on output FET selection as well as Tripath application notes "FETs – Selection and Efficiency" and "Designing with Switching Amplifiers for Performance and Reliability".

The output filter L100/C114 is the low-pass filter that recovers the analog audio signal. One of the benefits of the Class-T design is the ability to use output filters with relatively high cutoff frequencies. This greatly reduces the speaker interactions that can occur with the use of lower-frequency filters common in Class-D designs. Also, the higher-frequency operation means that the filter can be of a lower order (simpler and less costly).

The OEM may benefit from some experimentation in the filter design, but the values provided in the reference design, $11\mu\text{H}$, $0.1\mu\text{F}$, $0.22\mu\text{F}$ (nominal resonant frequency of 65kHz), provide excellent results for most loads between 2Ω and 4Ω . Figure 10 below shows the SPICE simulation results for the output filter used on the Bridged RB-TA3020-3 board with a 4Ω load. Figure 11 below shows the SPICE simulation results for the output filter used on the Bridged RB-TA3020-3 board with a 2Ω load. The Y axis of the graph is in units of dB referred to 1V. The X axis of the graph is in units of Hz. All of the Bridged RB-TA3020-X boards will have the same frequency response, however the gains will be different.

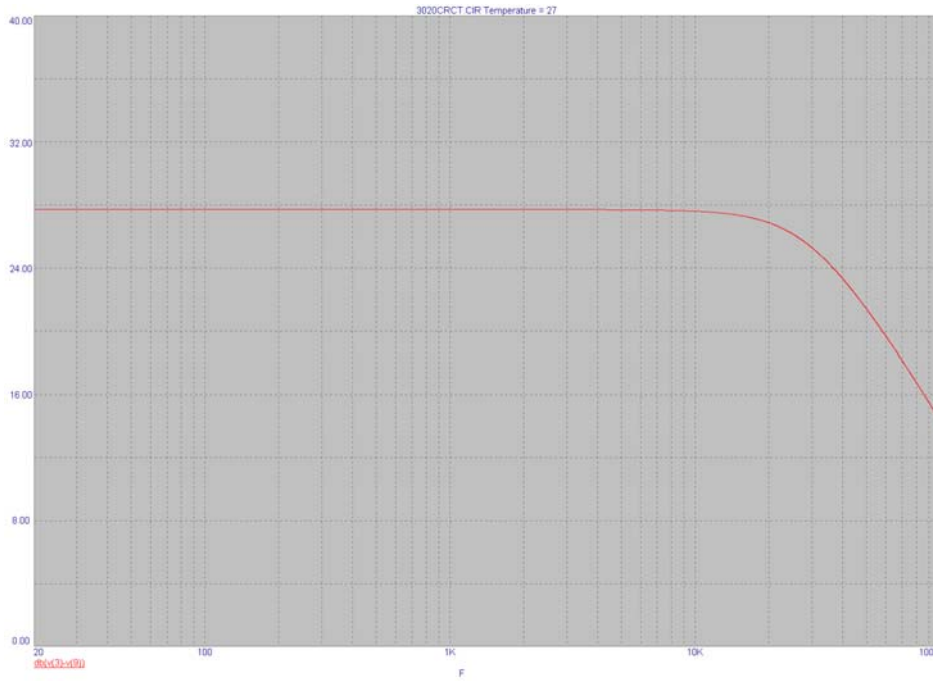

Figure 10

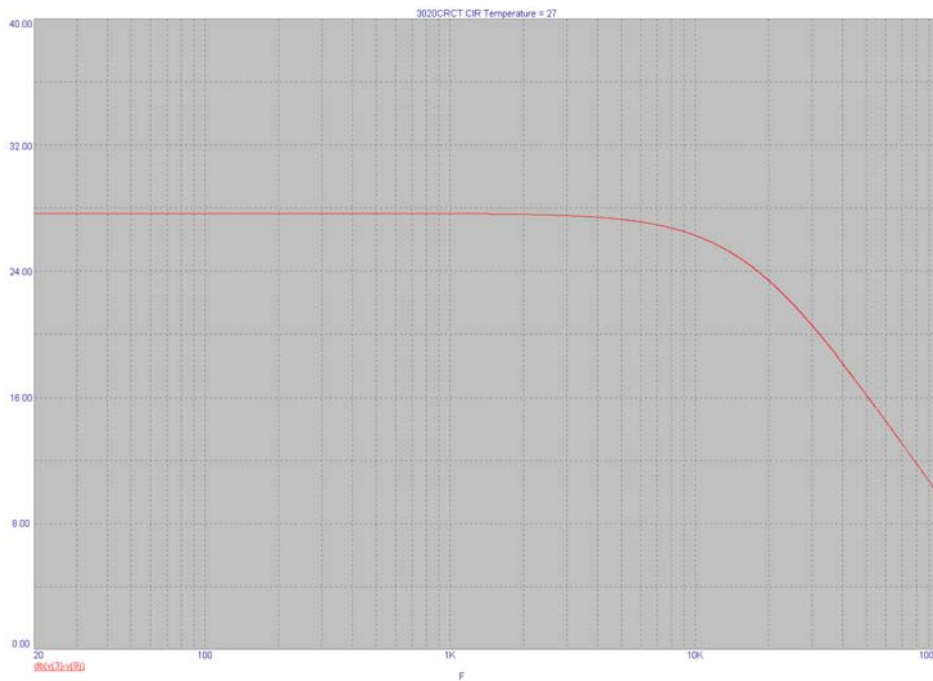

Figure 11

As important as the values themselves, the material used in the core is important to the performance of the filter. Core materials that saturate easily will not provide acceptable distortion or efficiency figures. Tripath recommends a low- μ core, like type 2 iron powder core. Micrometals, (www.micrometals.com), is a main supplier of iron powder cores. The core part number used on the Bridged RB-TA3020-1 and the Bridged RB-TA3020-2 is T106-2. The core part number used on the Bridged RB-TA3020-3 is T157-2.

The Zobel circuit R128/C117 is used in case the amplifier is powered up with no load attached. The Q of the LC output filter, with no load attached, rises quickly out to 80kHz. Resonant currents

in the filter and ringing on the output could reduce the reliability of the amplifier. The Zobel eliminates these problems by reducing the Q of the network significantly above 50kHz. Modifying the LC output filter will require a recalculation of the Zobel value, and depending on the application, the power capability of R117 and R217 may need to be increased to 10W from 5W. The components used on the evaluation board should be adequate for most applications.

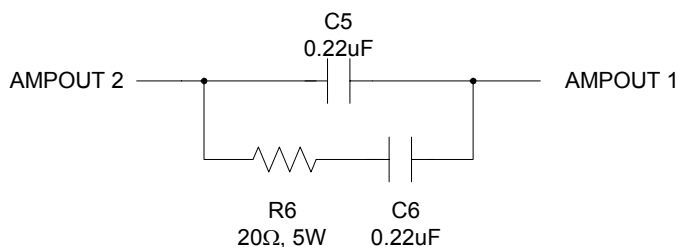

Figure 12

Figure 12 shows the differential filter network. The differential capacitor, C5, is used to reduce any of the differential switching components between the positive and negative outputs. Similar to the zobel circuit, the common mode zobel network, is used in case the amplifier is powered up with no load attached to the output. The common mode LC output filter formed by L100, L200 and C5 has a Q that rises quickly out to 80kHz. Common mode resonant currents in the filter and ringing on the output could reduce the reliability of the amplifier. This common mode zobel network reduces the Q of the common mode LC output filter significantly above 50kHz.

The bypass capacitors C108/C109 are critical to the reduction of ringing, overshoots, and undershoots on the outputs of the FETs. These parts are placed as closely as possible to the leads of the FETs, and the leads of the capacitors themselves are as short as practical. Their values will not change with different output FETs.

Differences between the Bridged RB-TA3020-X boards

The Bridged RB-TA3020-X boards can be directly implemented into a system. They were intended to be scalable and modular to help simplify the manufacturing of multiple systems with varying output power. This is the reason there are three boards for three different power levels that use identical PC boards. The differences between the three boards are changes in resistor values and capacitor voltages. Please refer to the bill of materials that is attached at the end of this document for the actual values of components used for each board.

DOCUMENTATION

Schematics and layout in software or paper form can be provided upon request.

ADVANCED INFORMATION

This is a product in development. Tripath Technology, Inc. reserves the right to make any changes without further notice to improve reliability, function and design.

Tripath and Digital Power Processing are trademarks of Tripath Technology, Inc. Other trademarks referenced in this document are owned by their respective companies.

Tripath Technology, Inc. reserves the right to make changes without further notice to any products herein to improve reliability, function or design. Tripath does not assume any liability arising out of the application of use of any product or circuit described herein; neither does it convey any license under its patent rights nor the rights of others.

TRIPATH'S PRODUCT ARE NOT AUTHORIZED FOR USE AS CRITICAL COMPONENTS IN LIFE SUPPORT DEVICES OR SYSTEMS WITHOUT THE EXPRESS WRITTEN CONSENT OF THE PRESIDENT OF TRIPATH TECHNOLOGY, INC. As used herein:

1. Life support devices or systems are devices or systems which, (a) are intended for surgical implant into the body, or (b) support or sustain life, and whose failure to perform, when properly used in accordance with instructions for use provided in this labeling, can be reasonably expected to result in significant injury of the user.
2. A critical component is any component of a life support device or system whose failure to perform can be reasonably expected to cause the failure of the life support device or system, or to affect its safety or effectiveness.

Contact Information

TRIPATH TECHNOLOGY, INC

2560 Orchard Parkway, San Jose, CA 95131

408.750.3000 - P

408.750.3001 - F

For more Sales Information, please visit us @ www.tripath.com/contact.htm

For more Technical Information, please visit us @ www.tripath.com/data.htm

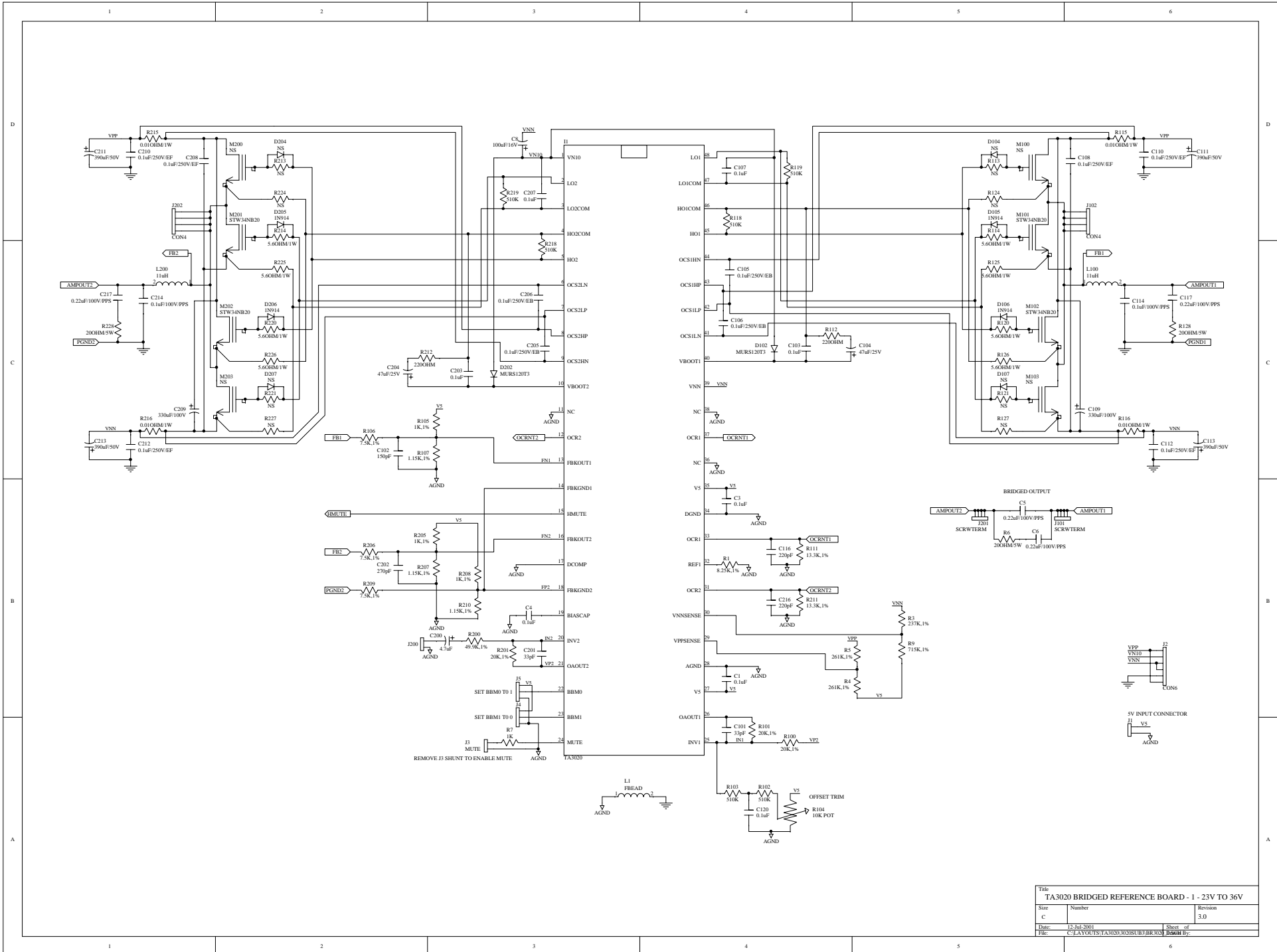

Title: TA3020 BRIDGED REFERENCE BOARD - 1 - 23V TO 36V		
Size: C	Number:	Revision: 3.0
Date: 12-Jul-2001	Sheet: 1 of 1	Drawn by: [Name]
File: C:\AVI\US\AVI01\KOSUR\BFR0201	Sheet: 1 of 1	Drawn by: [Name]

Bill of Material for Bridged RB-TA3020-1, Rev 3.0

Used	Part Type	Designator	Footprint	Part Field 1	Part Field 2	Part Field 3
====	=====	=====	=====	=====	=====	=====
4	0.01OHM/1W	R115 R116 R215 R216	RLVR1RG2	OHMITE	12F010	DK 12F010-ND
8	0.1uF	C1 C103 C107 C120 C203 C207 C3 C4	0805	20% TOL.	*	*
2	0.1uF/100V/PPS	C114 C214	C0U22PPS10	PANASONIC	ECH-S1104JZ	DK PS1104J-ND
4	0.1uF/250V/EB	C105 C106 C205 C206	C0U1MF10	PANASONIC	ECQ-E2104KB	DK P10967-ND
6	0.1uF/250V/EF	C108 C110 C112 C208 C210 C212	C0U1MF10	PANASONIC	ECQ-E2104KF	EF2104-ND
4	0.22uF/100V/PPS	C117 C217 C5 C6	C0U22PPS10	PANASONIC	ECH-S1224JZ	DK PS1224J-ND
3	1.15K,1%	R107 R207 R210	0805	*	*	*
1	100uF/16V	C8	C10UEL05	PANASONIC	ECA-1CHG101	DK P5529-ND
1	10K POT	R104	POTSTURN	BOURNS	3306P-1-103	DK 3306P-103-ND
2	11uH	L100 L200	T106	COIL WINDING SPEC	T106-2 CORE	29TURNS / 16AWG
2	13.3K,1%	R111 R211	0805	*	*	*
1	150pF	C102	0805	NPO 5%	*	*
1	1K	R7	0805	5%	*	*
3	1K,1%	R105 R205 R208	0805	*	*	*
4	1N914	D105 D106 D205 D206	1N914L			*
3	20K,1%	R100 R101 R201	0805	*	*	*
3	20OHM/5W	R128 R228 R6	PWR5WRT	XICON		280-PRM5-20
2	220OHM	R112 R212	RES1W50	5%, 1/4W		
2	220pF	C116 C216	0805	NPO 5%	*	*
1	237K,1%	R3	0805	*	*	*
2	261K,1%	R4 R5	0805	*	*	*
1	270pF	C202	0805	NPO 5%	*	*
2	330uF/100V	C109 C209	C330UEL10	PANASONIC	EEU-FC2A331S	DK P10783-ND
2	33pF	C101 C201	0805	NPO 5%	*	*
4	390uF/50V	C111 C113 C211 C213	C100UEL06	PANASONIC	EEU-FC1H391S	DK P10327-ND
1	4.7uF	C200	C10UEL05	PANASONIC	ECA-1HHG4R7	DK P5566-ND
2	47uF/25V	C104 C204	C10UEL05	PANASONIC	ECA-1HHG220	DK P5568-ND
1	49.9K,1%	R200	0805	*	*	*
8	5.6OHM/1W	R114 R120 R125 R126 R214 R220 R225 R226	RES1W50	PANASONIC	ERG-1SJ5R6	P5.6W-1BK-ND
6	510K	R102 R103 R118 R119 R218 R219	0805	5% TOL.	*	*
3	7.5K,1%	R106 R206 R209	0805	*	*	*

1	715K,1%	R9	0805	*	*	*
1	8.25K,1%	R1	0805	*	*	*
1	CON2INPT	J200	CON2	WALDOM	705-43-0001	DK WM4800-ND
1	CON2LPWR	J1	CON2B	WALDOM	22-23-2021	DK WM4200-ND
2	CON4	J102 J202	BUSBAR1	*	*	*
1	CON6	J2	PWRCON6	*	*	*
1	FBEAD	L1	2512	SPC/MULTICOMP	SPC5304	Newark - 50N670
1	HDR2	J3	GJMPR001	*	*	*
2	HDR3	J4 J5	GJMP3001	*	*	*
2	MURS120T3	D102 D202	SMB	MOTOROLA	MURS120T3	*
16	NS	D104 D107 D204 D207 M100 M103 M200 M203 R113 R121 R124 R127 R213 R221 R224 R227	1N914L			*
2	SCRWTERM	J101 J201	SCRWTERM	*	*	*
4	STW34NB20	M101 M102 M201 M202	TO3P&220FLT	ST MICROELECTRONICS	*	*
1	TA3020	I1	DIP48	TRIPATH	*	*

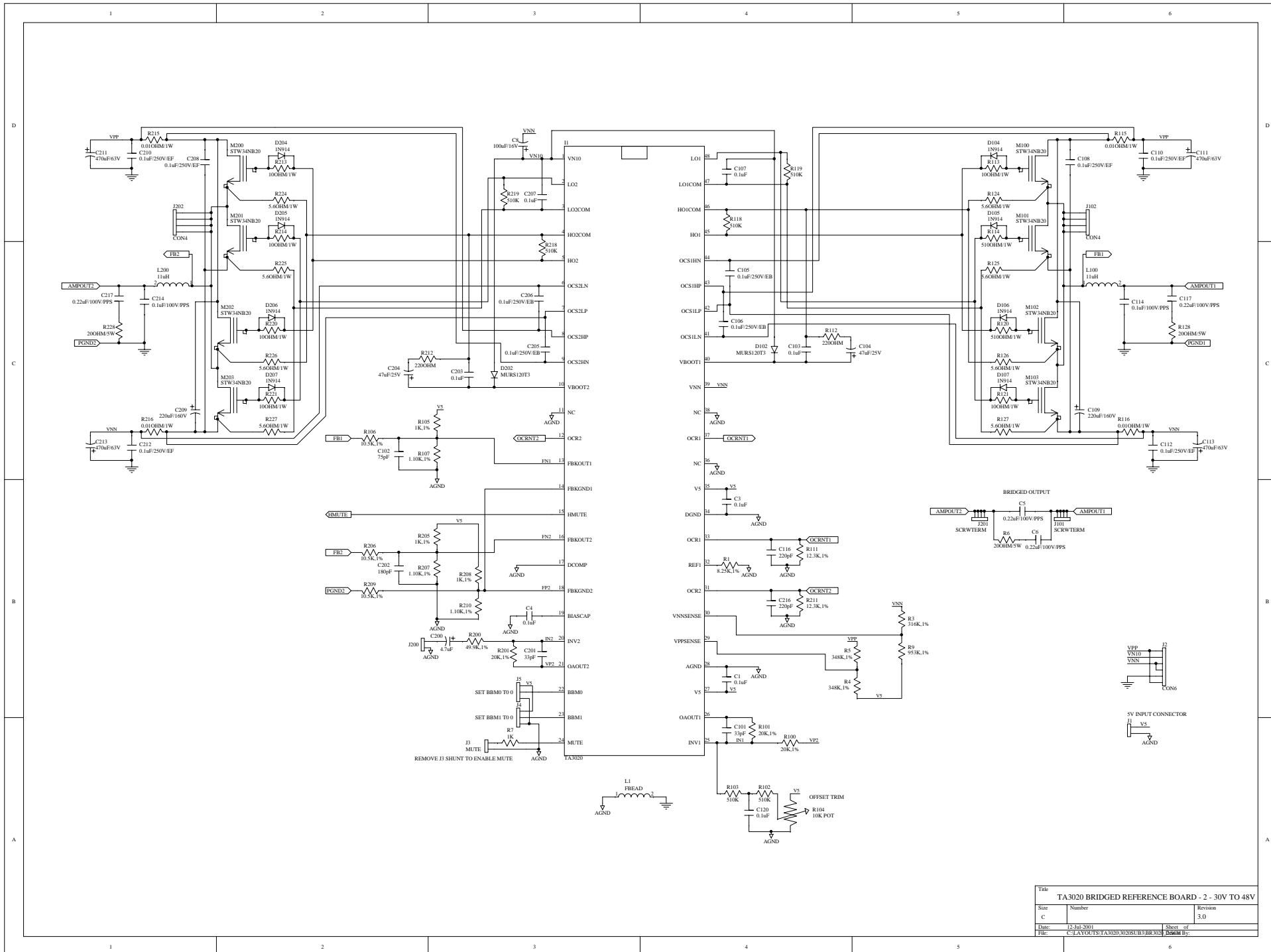

Title		
TA3020 BRIDGED REFERENCE BOARD - 2 - 30V TO 48V		
Size	Number	Revision
C		3.0
Date:	12-Jul-2001	Sheet of
File:	C:\AVI\US\AVI01\KOSUR\FBR\REF3020	Drawn By:

Bill of Material for Bridged RB-TA3020-2, Rev 3.0

Used	Part Type	Designator	Footprint	Part Field 1	Part Field 2	Part Field 3
====	=====	=====	=====	=====	=====	=====
4	0.01OHM/1W	R115 R116 R215 R216	RLVR1RG2	OHMITE	12F010	DK 12F010-ND
8	0.1uF	C1 C103 C107 C120 C203 C207 C3 C4	0805	20% TOL.	*	*
2	0.1uF/100V/PPS	C114 C214	C0U22PPS10	PANASONIC	ECH-S1104JZ	DK PS1104J-ND
4	0.1uF/250V/EB	C105 C106 C205 C206	C0U1MF10	PANASONIC	ECQ-E2104KB	DK P10967-ND
6	0.1uF/250V/EF	C108 C110 C112 C208 C210 C212	C0U1MF10	PANASONIC	ECQ-E2104KF	EF2104-ND
4	0.22uF/100V/PPS	C117 C217 C5 C6	C0U22PPS10	PANASONIC	ECH-S1224JZ	DK PS1224J-ND
3	1.10K,1%	R107 R207 R210	0805	*	*	*
3	10.5K,1%	R106 R206 R209	0805	*	*	*
1	100uF/16V	C8	C10UEL05	PANASONIC	ECA-1CHG101	DK P5529-ND
1	10K POT	R104	POTSTURN	BOURNS	3306P-1-103	DK 3306P-103-ND
6	100OHM/1W	R113 R121 R213 R214 R220 R221	RES1W50	PANASONIC	ERG-1SJ5R6	P5.6W-1BK-ND
2	11uH	L100 L200	T106	COIL WINDING SPEC	T106-2 CORE	29TURNS / 16AWG
2	12.3K,1%	R111 R211	0805	*	*	*
1	180pF	C202	0805	NPO 5%	*	*
1	1K	R7	0805	5%	*	*
3	1K,1%	R105 R205 R208	0805	*	*	*
8	1N914	D104 D105 D106 D107 D204 D205 D206 D207	1N914L			*
3	20K,1%	R100 R101 R201	0805	*	*	*
3	200OHM/5W	R128 R228 R6	PWR5WRT	XICON		280-PRM5-20
2	220OHM	R112 R212	RES1W50	5%, 1/4W		
2	220pF	C116 C216	0805	NPO 5%	*	*
2	220uF/160V	C109 C209	C330UEL10	PANASONIC	EEU-EB2C221S	DK P5910-ND
1	316K,1%	R3	0805	*	*	*
2	33pF	C101 C201	0805	NPO 5%	*	*
2	348K,1%	R4 R5	0805	*	*	*
1	4.7uF	C200	C10UEL05	PANASONIC	ECA-1HHG4R7	DK P5566-ND
4	470uF/63V	C111 C113 C211 C213	C100UEL06	PANASONIC	EEU-FC1J471	DK P10352-ND
2	47uF/25V	C104 C204	C10UEL05	PANASONIC	ECA-1HHG220	DK P5568-ND
1	49.9K,1%	R200	0805	*	*	*
8	5.6OHM/1W	R124 R125 R126 R127 R224 R225 R226 R227	RES1W50	PANASONIC	ERG-1SJ5R6	P5.6W-1BK-ND

6	510K	R102 R103 R118 R119	0805	5% TOL.	*	*
		R218 R219				
2	510OHM/1W	R114 R120	RES1W50	PANASONIC	ERG-1SJ5R6	P5.6W-1BK-ND
1	75pF	C102	0805	NPO 5%	*	*
1	8.25K,1%	R1	0805	*	*	*
1	953K,1%	R9	0805	*	*	*
1	CON2INPT	J200	CON2	WALDOM	705-43-0001	DK WM4800-ND
1	CON2LPWR	J1	CON2B	WALDOM	22-23-2021	DK WM4200-ND
2	CON4	J102 J202	BUSBAR1	*	*	*
1	CON6	J2	PWRCON6	*	*	*
1	FBEAD	L1	2512	SPC/MULTICOMP	SPC5304	Newark - 50N670
1	HDR2	J3	GJMPR001	*	*	*
2	HDR3	J4 J5	GJMP3001	*	*	*
2	MURS120T3	D102 D202	SMB	MOTOROLA	MURS120T3	*
2	SCRWTERM	J101 J201	SCRWTERM	*	*	*
8	STW34NB20	M100 M101 M102 M103	TO3P&220FLT	ST MICROELECTRONICS	*	*
		M200 M201 M202 M203				
1	TA3020	I1	DIP48	TRIPATH	*	*

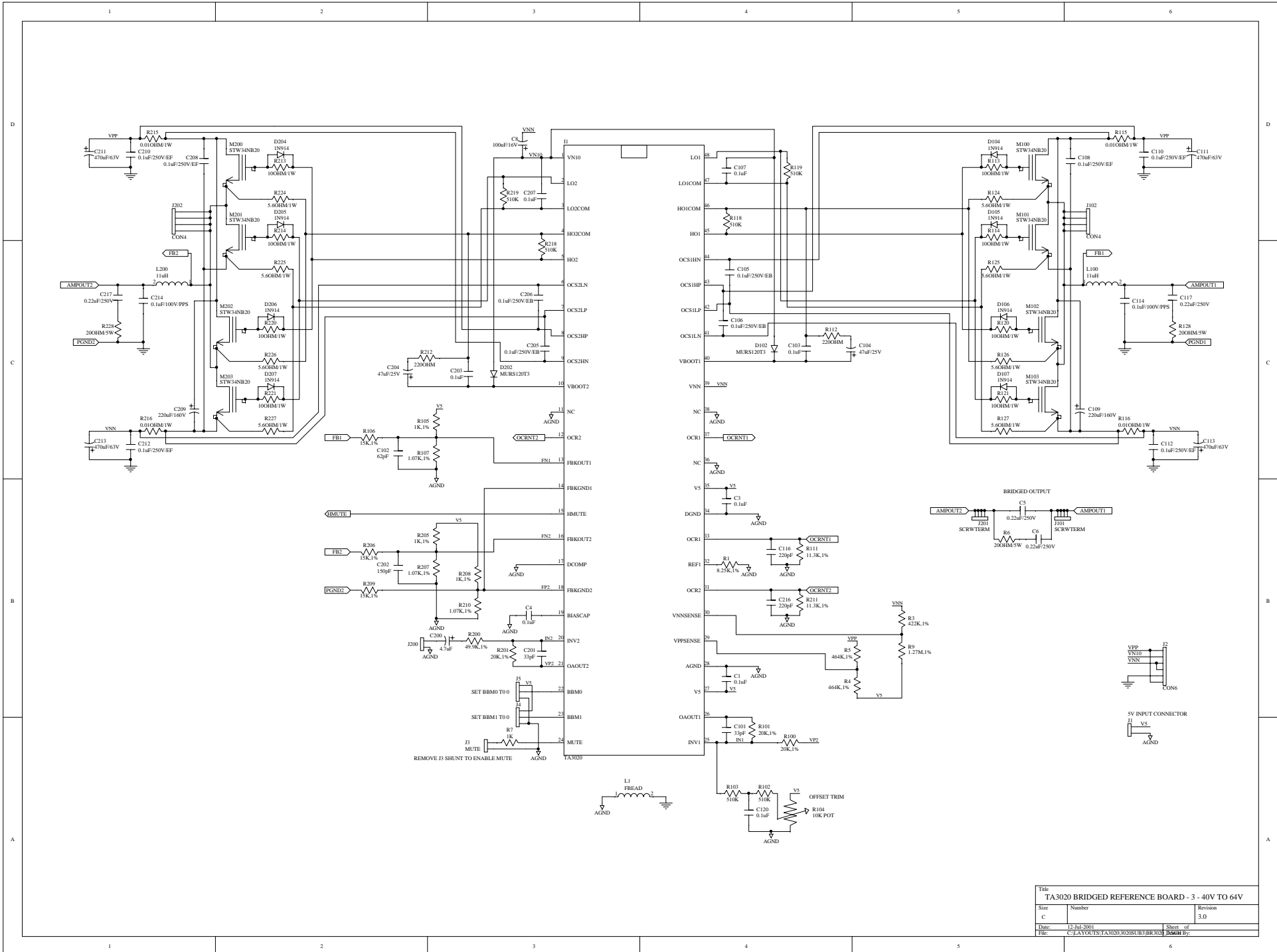

Title		
TA3020 BRIDGED REFERENCE BOARD - 3 - 40V TO 64V		
Size	Number	Revision
C		3.0
Date:	12-Jul-2001	Sheet of
File:	C:\AVI\US\AVI01\KOSUR\FBR020	Drawn by:

Bill of Material for Bridged RB-TA3020-3, Rev 3.0

Used	Part Type	Designator	Footprint	Part Field 1	Part Field 2	Part Field 3
====	=====	=====	=====	=====	=====	=====
4	0.01OHM/1W	R115 R116 R215 R216	RLVR1RG2	OHMITE	12F010	DK 12F010-ND
8	0.1uF	C1 C103 C107 C120 C203 C207 C3 C4	0805	20% TOL.	*	*
2	0.1uF/100V/PPS	C114 C214	C0U22PPS10	PANASONIC	ECH-S1104JZ	DK PS1104J-ND
4	0.1uF/250V/EB	C105 C106 C205 C206	C0U1MF10	PANASONIC	ECQ-E2104KB	DK P10967-ND
6	0.1uF/250V/EF	C108 C110 C112 C208 C210 C212	C0U1MF10	PANASONIC	ECQ-E2104KF	EF2104-ND
4	0.22uF/250V	C117 C217 C5 C6	C0U22PPS10	PANASONIC	ECW-F2224JB	DK PF2224-ND
3	1.07K,1%	R107 R207 R210	0805	*	*	*
1	1.27M,1%	R9	0805	*	*	*
1	100uF/16V	C8	C10UEL05	PANASONIC	ECA-1CHG101	DK P5529-ND
1	10K POT	R104	POTSTURN	BOURNS	3306P-1-103	DK 3306P-103-ND
8	10OHM/1W	R113 R114 R120 R121 R213 R214 R220 R221	RES1W50	PANASONIC	ERG-1SJ5R6	P10W-1BK-ND
2	11.3K,1%	R111 R211	0805	*	*	*
2	11uH	L100 L200	T106	COIL WINDING SPEC	T157-2 CORE	28TURNS / 14AWG
1	150pF	C202	0805	NPO 5%	*	*
3	15K,1%	R106 R206 R209	0805	*	*	*
1	1K	R7	0805	5%	*	*
3	1K,1%	R105 R205 R208	0805	*	*	*
8	1N914	D104 D105 D106 D107 D204 D205 D206 D207	1N914L			*
3	20K,1%	R100 R101 R201	0805	*	*	*
3	20OHM/5W	R128 R228 R6	PWR5WRT	XICON		280-PRM5-20
2	220OHM	R112 R212	RES1W50	5%, 1/4W		
2	220pF	C116 C216	0805	NPO 5%	*	*
2	220uF/160V	C109 C209	C330UEL10	PANASONIC	EEU-EB2C221S	DK P5910-ND
2	33pF	C101 C201	0805	NPO 5%	*	*
1	4.7uF	C200	C10UEL05	PANASONIC	ECA-1HHG4R7	DK P5566-ND
1	422K,1%	R3	0805	*	*	*
2	464K,1%	R4 R5	0805	*	*	*
4	470uF/63V	C111 C113 C211 C213	C100UEL06	PANASONIC	EEU-FC1J471	DK P10352-ND
2	47uF/25V	C104 C204	C10UEL05	PANASONIC	ECA-1HHG220	DK P5568-ND
1	49.9K,1%	R200	0805	*	*	*
8	5.6OHM/1W	R124 R125 R126 R127	RES1W50	PANASONIC	ERG-1SJ5R6	P5.6W-1BK-ND

6	510K	R224 R225 R226 R227 R102 R103 R118 R119 R218 R219	0805	5% TOL.	*	*
1	62pF	C102	0805	NPO 5%	*	*
1	8.25K,1%	R1	0805	*	*	*
1	CON2INPT	J200	CON2	WALDOM	705-43-0001	DK WM4800-ND
1	CON2LPWR	J1	CON2B	WALDOM	22-23-2021	DK WM4200-ND
2	CON4	J102 J202	BUSBAR1	*	*	*
1	CON6	J2	PWRCON6	*	*	*
1	FBEAD	L1	2512	SPC/MULTICOMP	SPC5304	Newark - 50N670
1	HDR2	J3	GJMPR001	*	*	*
2	HDR3	J4 J5	GJMP3001	*	*	*
2	MURS120T3	D102 D202	SMB	MOTOROLA	MURS120T3	*
2	SCRWTERM	J101 J201	SCRWTERM	*	*	*
8	STW34NB20	M100 M101 M102 M103 M200 M201 M202 M203	TO3P&220FLT	ST MICROELECTRONICS	*	*
1	TA3020	I1	DIP48	TRIPATH	*	*

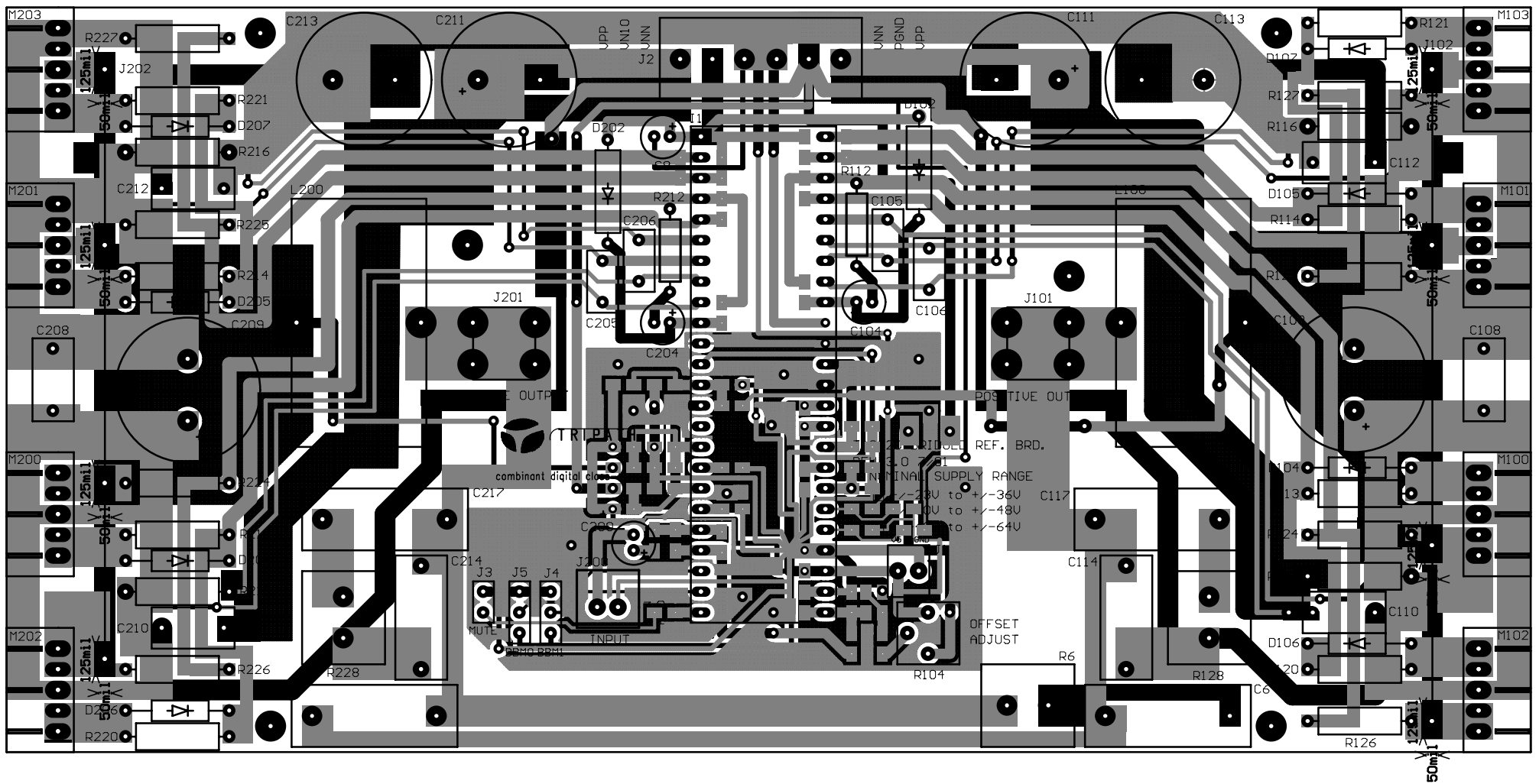

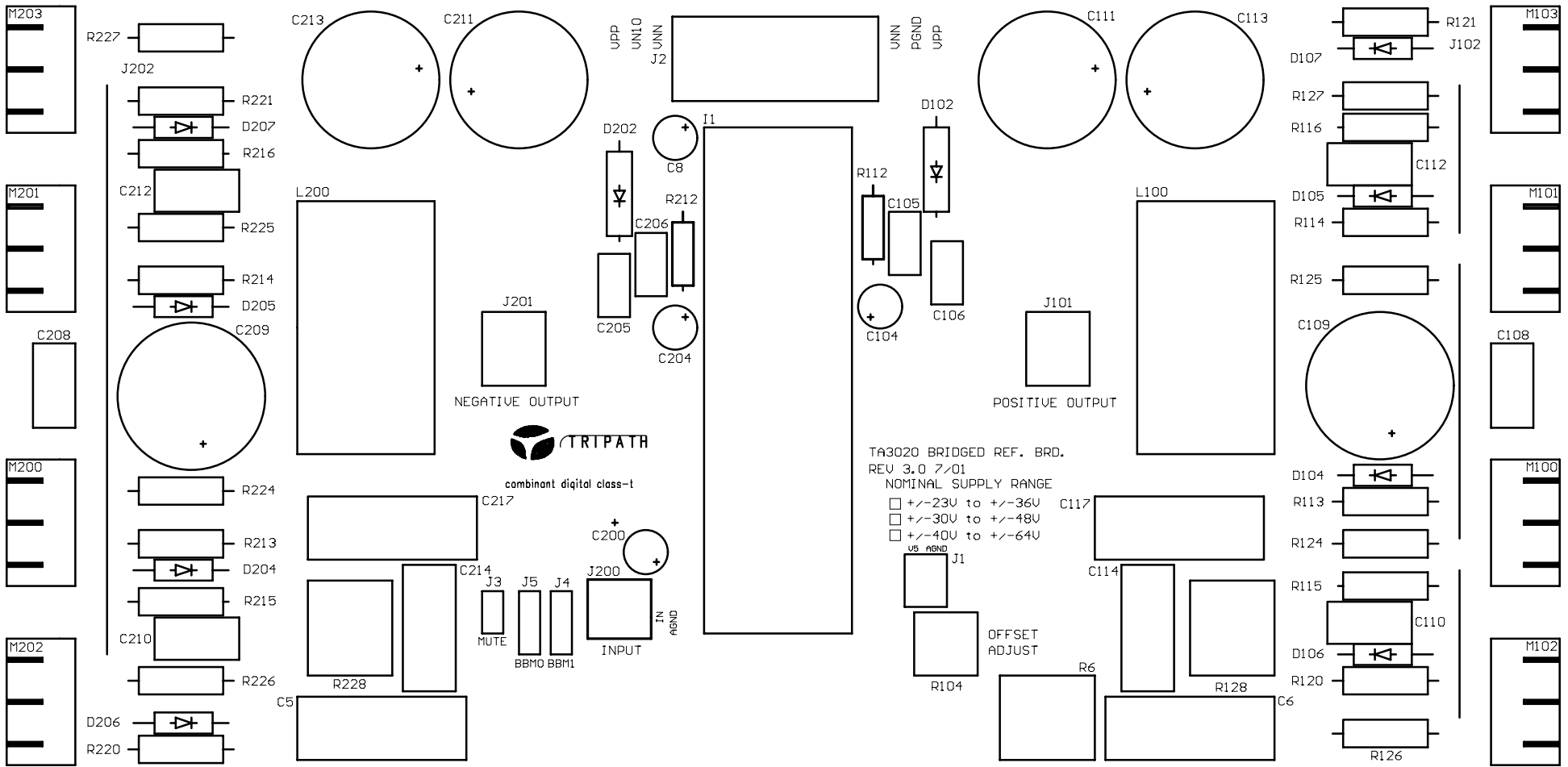

combinant digital class-t

TA3020 BRIDGED REF. BRD.

REV 3.0 7/01

NOMINAL SUPPLY RANGE

- +/-23V to +/-36V
- +/-30V to +/-48V
- +/-40V to +/-64V

US AGND

OFFSET ADJUST

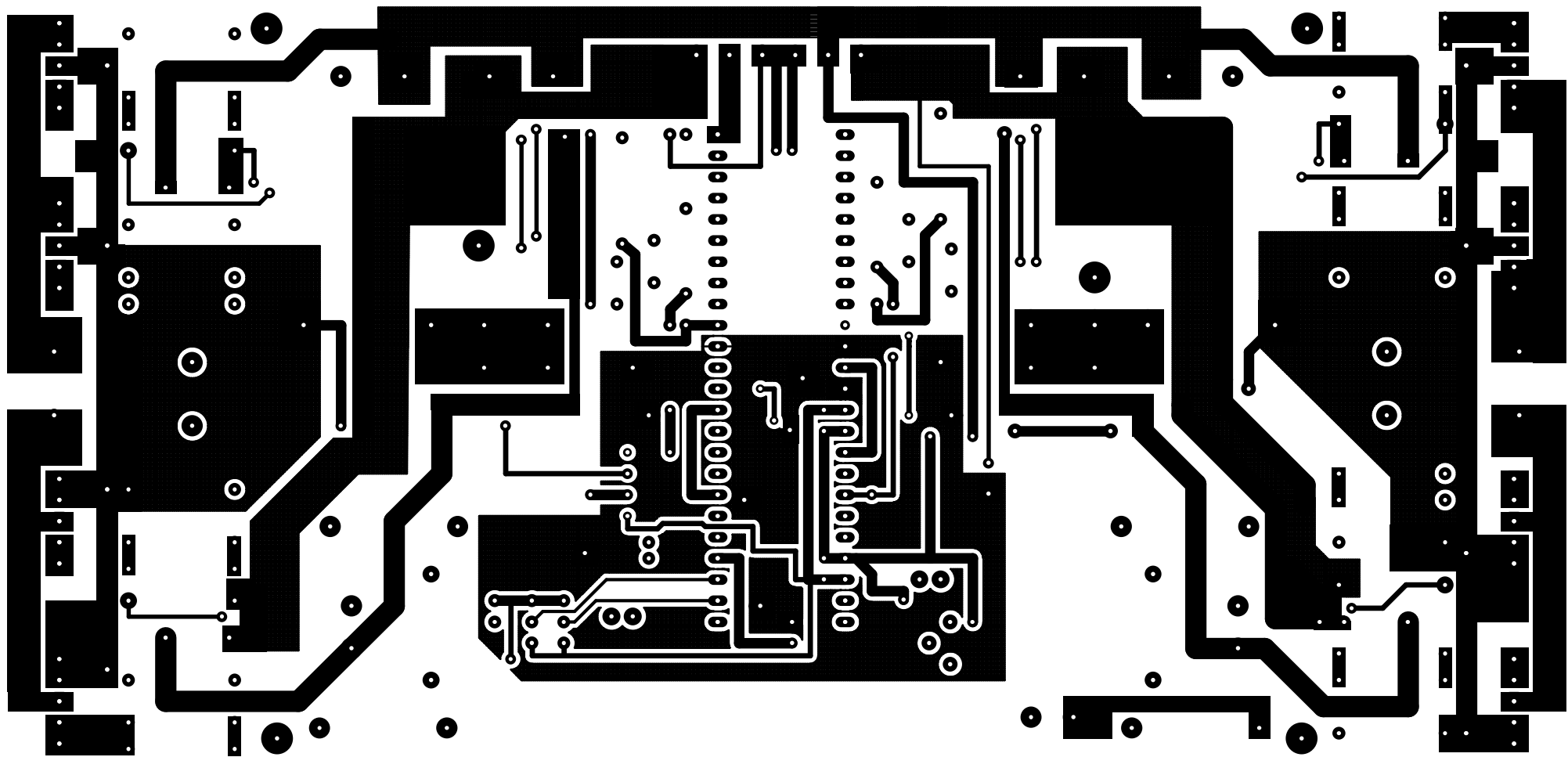

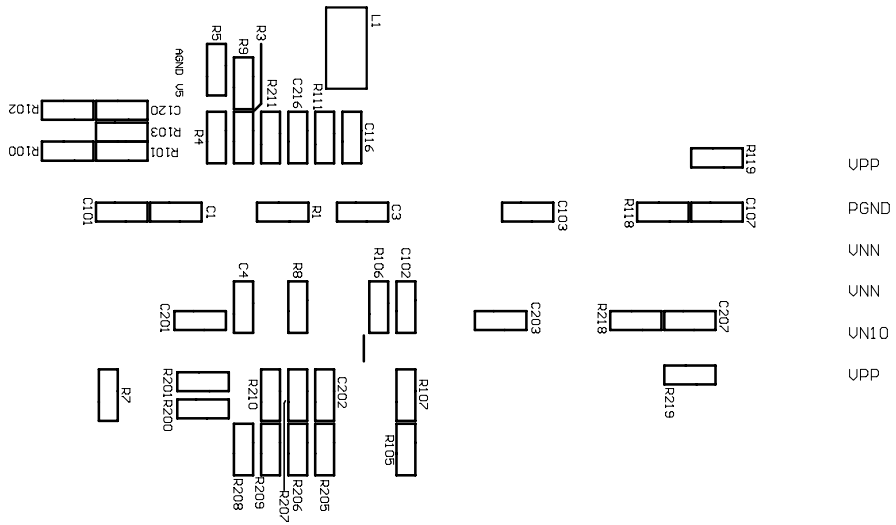
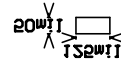
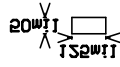
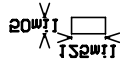
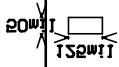

UPP
 PGND
 UNN
 UNN
 UN10
 UPP

