



# MICROCHIP 24AA00/24LC00/24C00

## 128 Bit I<sup>2</sup>C™ Bus Serial EEPROM

### DEVICE SELECTION TABLE

Device	Vcc Range	Temp Range
24AA00	1.8 - 6.0	C,I
24LC00	2.5 - 6.0	C,I
24C00	4.5 - 5.5	C,I,E

### FEATURES

- Low power CMOS technology
  - 500  $\mu$ A typical active current
  - 250 nA typical standby current
- Organized as 16 bytes x 8 bits
- 2-wire serial interface bus, I<sup>2</sup>C™ compatible
- 100 kHz (1.8V) and 400 kHz (5V) compatibility
- Self-timed write cycle (including auto-erase)
- 4 ms maximum byte write cycle time
- 1,000,000 erase/write cycles guaranteed
- ESD protection > 4 kV
- Data retention > 200 years
- 8L DIP, SOIC, TSSOP and 5L SOT-23 packages
- Temperature ranges available:
  - Commercial (C): 0°C to +70°C
  - Industrial (I): -40°C to +85°C
  - Automotive (E): -40°C to +125°C

### DESCRIPTION

The Microchip Technology Inc. 24AA00/24LC00/24C00 (24xx00\*) is a 128-bit Electrically Erasable PROM memory organized as 16 x 8 with a 2-wire serial interface. Low voltage design permits operation down to 1.8 volts for the 24xx00 version, and every version maintains a maximum standby current of only 1  $\mu$ A and typical active current of only 500  $\mu$ A. This device was designed for where a small amount of EEPROM is needed for the storage of calibration values, ID numbers or manufacturing information, etc. The 24xx00 is available in 8-pin PDIP, 8-pin SOIC (150 mil), 8-pin TSSOP and the 5-pin SOT-23 packages.

### PACKAGE TYPES

#### 8-PIN PDIP/SOIC

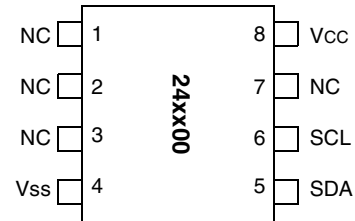

#### 8-PIN TSSOP

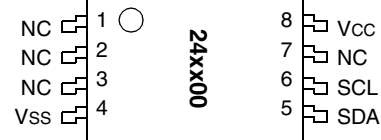

#### 5-PIN SOT-23

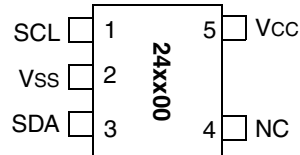

### BLOCK DIAGRAM

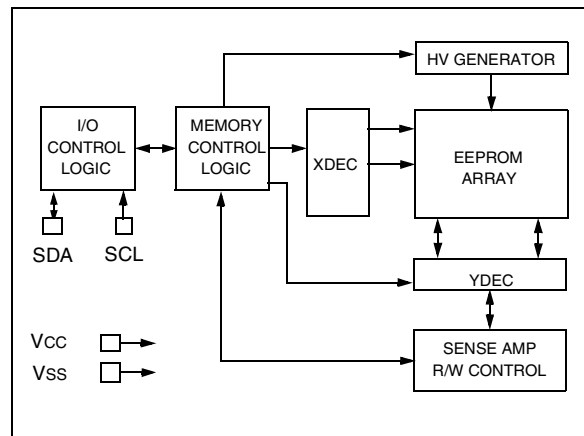

I<sup>2</sup>C is a trademark of Philips Corporation.

\*24xx00 is used in this document as a generic part number for the 24AA00/24LC00/24C00 devices.

# 24AA00/24LC00/24C00

## 1.0 ELECTRICAL CHARACTERISTICS

### 1.1 Maximum Ratings\*

V<sub>CC</sub>.....7.0V  
 All inputs and outputs w.r.t. V<sub>SS</sub> ..... -0.6V to V<sub>CC</sub> +1.0V  
 Storage temperature ..... -65°C to +150°C  
 Ambient temp. with power applied ..... -65°C to +125°C  
 Soldering temperature of leads (10 seconds) ..... +300°C  
 ESD protection on all pins ..... 4 kV

\***Notice:** Stresses above those listed under "Maximum ratings" may cause permanent damage to the device. This is a stress rating only and functional operation of the device at those or any other conditions above those indicated in the operational listings of this specification is not implied. Exposure to maximum rating conditions for extended periods may affect device reliability.

TABLE 1-1 PIN FUNCTION TABLE

Name	Function
V <sub>SS</sub>	Ground
SDA	Serial Data
SCL	Serial Clock
V <sub>CC</sub>	+1.8V to 6.0V (24AA00) +2.5V to 6.0V (24LC00) +4.5V to 5.5V (24C00)
NC	No Internal Connection

TABLE 1-2 DC CHARACTERISTICS

Parameter	Symbol	Min.	Max.	Units	Conditions
All Parameters apply across the recommended operating ranges unless otherwise noted					
Commercial (C): Tamb = 0°C to +70°C, V <sub>CC</sub> = 1.8V to 6.0V Industrial (I): Tamb = -40°C to +85°C, V <sub>CC</sub> = 1.8V to 6.0V Automotive (E) Tamb = -40°C to +125°C, V <sub>CC</sub> = 4.5V to 5.5V					
SCL and SDA pins: High level input voltage	V <sub>IH</sub>	0.7 V <sub>CC</sub>		V	(Note)
Low level input voltage	V <sub>IL</sub>		0.3 V <sub>CC</sub>	V	(Note)
Hysteresis of Schmitt trigger inputs	V <sub>HYS</sub>	.05 V <sub>CC</sub>	—	V	V <sub>CC</sub> ≥ 2.5V (Note)
Low level output voltage	V <sub>OL</sub>		.40	V	I <sub>OL</sub> = 3.0 mA, V <sub>CC</sub> = 4.5V I <sub>OL</sub> = 2.1 mA, V <sub>CC</sub> = 2.5V
Input leakage current	I <sub>LI</sub>	-10	10	μA	V <sub>IN</sub> = V <sub>CC</sub> or V <sub>SS</sub>
Output leakage current	I <sub>LO</sub>	-10	10	μA	V <sub>OUT</sub> = V <sub>CC</sub> or V <sub>SS</sub>
Pin capacitance (all inputs/outputs)	C <sub>IN</sub> , C <sub>OUT</sub>	—	10	pF	V <sub>CC</sub> = 5.0V (Note) Tamb = 25°C, f = 1 MHz
Operating current	I <sub>CC</sub> Write	—	2	mA	V <sub>CC</sub> = 5.5V, SCL = 400 kHz
	I <sub>CC</sub> Read	—	1	mA	V <sub>CC</sub> = 5.5V, SCL = 400 kHz
Standby current	I <sub>CCS</sub>	—	1	μA	V <sub>CC</sub> = 5.5V, SDA = SCL = V <sub>CC</sub>

**Note:** This parameter is periodically sampled and not 100% tested.

FIGURE 1-1: BUS TIMING DATA

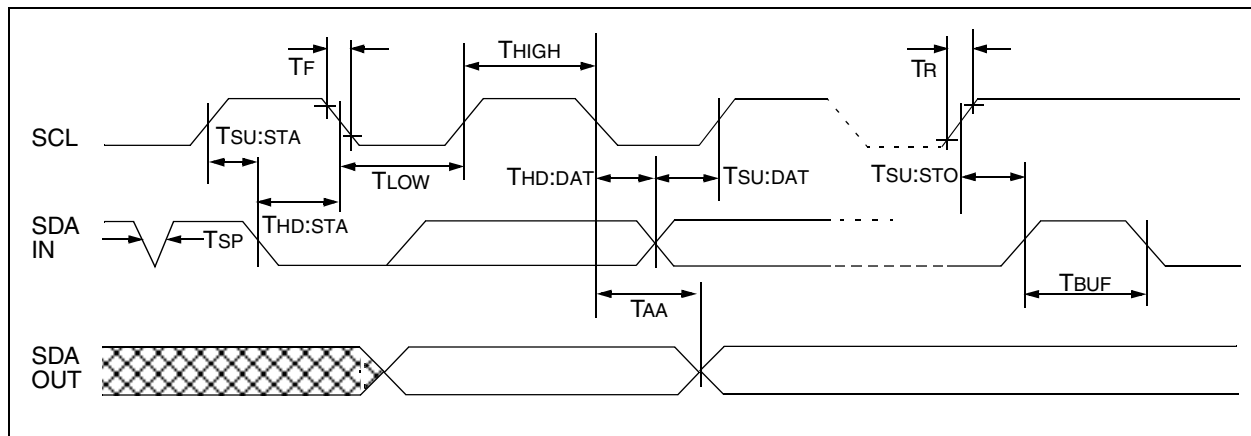

**TABLE 1-3 AC CHARACTERISTICS**

All Parameters apply across all recommended operating ranges unless otherwise noted		Commercial (C): Industrial (I): Automotive (E):		Tamb = 0°C to +70°C, Vcc = 1.8V to 6.0V Tamb = -40°C to +85°C, Vcc = 1.8V to 6.0V Tamb = -40°C to +125°C, Vcc = 4.5V to 5.5V	
Parameter	Symbol	Min	Max	Units	Conditions
Clock frequency	FCLK	— — —	100 100 400	kHz	4.5V ≤ Vcc ≤ 5.5V (E Temp range) 1.8V ≤ Vcc ≤ 4.5V 4.5V ≤ Vcc ≤ 6.0V
Clock high time	THIGH	4000 4000 600	— — —	ns	4.5V ≤ Vcc ≤ 5.5V (E Temp range) 1.8V ≤ Vcc ≤ 4.5V 4.5V ≤ Vcc ≤ 6.0V
Clock low time	TLOW	4700 4700 1300	— — —	ns	4.5V ≤ Vcc ≤ 5.5V (E Temp range) 1.8V ≤ Vcc ≤ 4.5V 4.5V ≤ Vcc ≤ 6.0V
SDA and SCL rise time (Note 1)	TR	— — —	1000 1000 300	ns	4.5V ≤ Vcc ≤ 5.5V (E Temp range) 1.8V ≤ Vcc ≤ 4.5V 4.5V ≤ Vcc ≤ 6.0V
SDA and SCL fall time	TF	—	300	ns	(Note 1)
START condition hold time	THD:STA	4000 4000 600	— — —	ns	4.5V ≤ Vcc ≤ 5.5V (E Temp range) 1.8V ≤ Vcc ≤ 4.5V 4.5V ≤ Vcc ≤ 6.0V
START condition setup time	TSU:STA	4700 4700 600	— — —	ns	4.5V ≤ Vcc ≤ 5.5V (E Temp range) 1.8V ≤ Vcc ≤ 4.5V 4.5V ≤ Vcc ≤ 6.0V
Data input hold time	THD:DAT	0	—	ns	(Note 2)
Data input setup time	TSU:DAT	250 250 100	— — —	ns	4.5V ≤ Vcc ≤ 5.5V (E Temp range) 1.8V ≤ Vcc ≤ 4.5V 4.5V ≤ Vcc ≤ 6.0V
STOP condition setup time	TSU:STO	4000 4000 600	— — —	ns	4.5V ≤ Vcc ≤ 5.5V (E Temp range) 1.8V ≤ Vcc ≤ 4.5V 4.5V ≤ Vcc ≤ 6.0V
Output valid from clock (Note 2)	TAA	— — —	3500 3500 900	ns	4.5V ≤ Vcc ≤ 5.5V (E Temp range) 1.8V ≤ Vcc ≤ 4.5V 4.5V ≤ Vcc ≤ 6.0V
Bus free time: Time the bus must be free before a new transmission can start	TBUF	4700 4700 1300	— — —	ns	4.5V ≤ Vcc ≤ 5.5V (E Temp range) 1.8V ≤ Vcc ≤ 4.5V 4.5V ≤ Vcc ≤ 6.0V
Output fall time from VIH minimum to VIL maximum	TOF	20+0.1 CB	250	ns	(Note 1), CB ≤ 100 pF
Input filter spike suppression (SDA and SCL pins)	TSP	—	50	ns	(Notes 1, 3)
Write cycle time	TWC	—	4	ms	
Endurance		1M	—	cycles	25°C, Vcc = 5.0V, Block Mode (Note 4)

**Note 1:** Not 100% tested. CB = total capacitance of one bus line in pF.

**2:** As a transmitter, the device must provide an internal minimum delay time to bridge the undefined region (minimum 300 ns) of the falling edge of SCL to avoid unintended generation of START or STOP conditions.

**3:** The combined TSP and VHYS specifications are due to new Schmitt trigger inputs which provide improved noise spike suppression. This eliminates the need for a TI specification for standard operation.

**4:** This parameter is not tested but guaranteed by characterization. For endurance estimates in a specific application, please consult the Total Endurance Model which can be obtained on Microchip's BBS or website.

## 2.0 PIN DESCRIPTIONS

### 2.1 SDA Serial Data

This is a bi-directional pin used to transfer addresses and data into and data out of the device. It is an open drain terminal, therefore the SDA bus requires a pull-up resistor to V<sub>CC</sub> (typical 10 k $\Omega$  for 100 kHz, 2 k $\Omega$  for 400 kHz).

For normal data transfer SDA is allowed to change only during SCL low. Changes during SCL high are reserved for indicating the START and STOP conditions.

### 2.2 SCL Serial Clock

This input is used to synchronize the data transfer from and to the device.

### 2.3 Noise Protection

The SCL and SDA inputs have Schmitt trigger and filter circuits which suppress noise spikes to assure proper device operation even on a noisy bus.

## 3.0 FUNCTIONAL DESCRIPTION

The 24xx00 supports a bi-directional 2-wire bus and data transmission protocol. A device that sends data onto the bus is defined as a transmitter, and a device receiving data as a receiver. The bus has to be controlled by a master device which generates the serial clock (SCL), controls the bus access, and generates the START and STOP conditions, while the 24xx00 works as slave. Both master and slave can operate as transmitter or receiver, but the master device determines which mode is activated.

## 4.0 BUS CHARACTERISTICS

The following **bus protocol** has been defined:

- Data transfer may be initiated only when the bus is not busy.
- During data transfer, the data line must remain stable whenever the clock line is HIGH. Changes in the data line while the clock line is HIGH will be interpreted as a START or STOP condition.

Accordingly, the following bus conditions have been defined (Figure 4-1).

### 4.1 Bus not Busy (A)

Both data and clock lines remain HIGH.

### 4.2 Start Data Transfer (B)

A HIGH to LOW transition of the SDA line while the clock (SCL) is HIGH determines a START condition. All commands must be preceded by a START condition.

### 0.1 Stop Data Transfer (C)

A LOW to HIGH transition of the SDA line while the clock (SCL) is HIGH determines a STOP condition. All operations must be ended with a STOP condition.

### 4.3 Data Valid (D)

The state of the data line represents valid data when, after a START condition, the data line is stable for the duration of the HIGH period of the clock signal.

The data on the line must be changed during the LOW period of the clock signal. There is one bit of data per clock pulse.

Each data transfer is initiated with a START condition and terminated with a STOP condition. The number of the data bytes transferred between the START and STOP conditions is determined by the master device and is theoretically unlimited.

## 4.4 Acknowledge

Each receiving device, when addressed, is obliged to generate an acknowledge after the reception of each byte. The master device must generate an extra clock pulse which is associated with this acknowledge bit.

**Note:** The 24xx00 does not generate any acknowledge bits if an internal programming cycle is in progress.

The device that acknowledges has to pull down the SDA line during the acknowledge clock pulse in such a way that the SDA line is stable LOW during the HIGH period of the acknowledge related clock pulse. Of course, setup and hold times must be taken into account. A master must signal an end of data to the slave by not generating an acknowledge bit on the last byte that has been clocked out of the slave. In this case, the slave must leave the data line HIGH to enable the master to generate the STOP condition (Figure 4-2).

**FIGURE 4-1: DATA TRANSFER SEQUENCE ON THE SERIAL BUS**

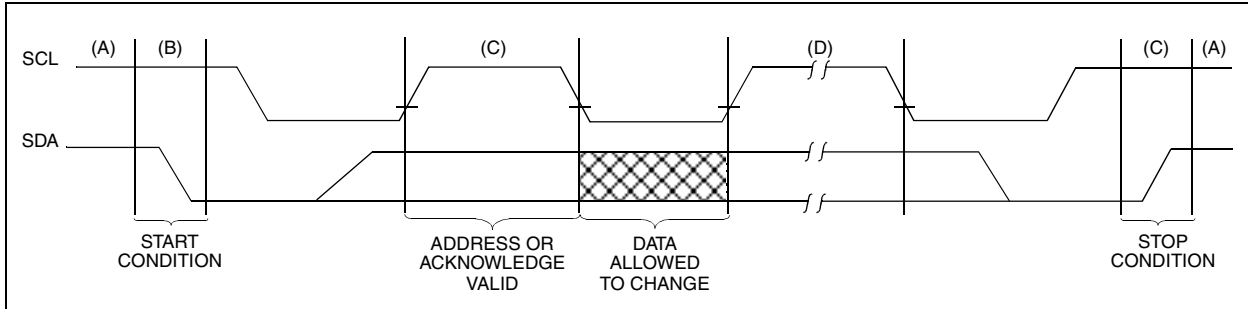

**FIGURE 4-2: ACKNOWLEDGE TIMING**

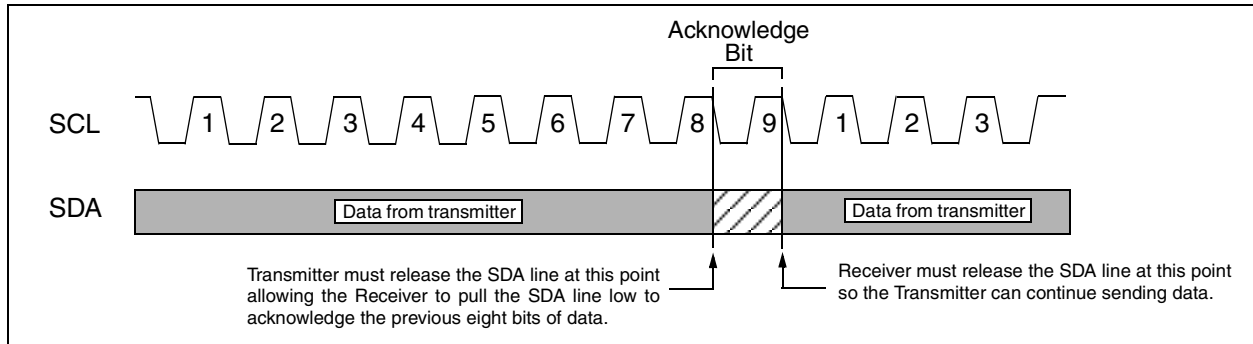

## 5.0 DEVICE ADDRESSING

After generating a START condition, the bus master transmits a control byte consisting of a slave address and a Read/Write bit that indicates what type of operation is to be performed. The slave address for the 24xx00 consists of a 4-bit device code (1010) followed by three don't care bits.

The last bit of the control byte determines the operation to be performed. When set to a one a read operation is selected, and when set to a zero a write operation is selected. (Figure 5-1). The 24xx00 monitors the bus for its corresponding slave address all the time. It generates an acknowledge bit if the slave address was true and it is not in a programming mode.

**FIGURE 5-1: CONTROL BYTE FORMAT**

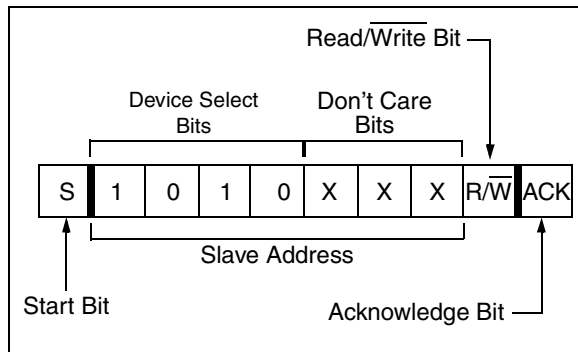

## 6.0 WRITE OPERATIONS

### 6.1 Byte Write

Following the start signal from the master, the device code (4 bits), the don't care bits (3 bits), and the R/W bit (which is a logic low) are placed onto the bus by the master transmitter. This indicates to the addressed slave receiver that a byte with a word address will follow after it has generated an acknowledge bit during the ninth clock cycle. Therefore, the next byte transmitted by the master is the word address and will be written into the address pointer of the 24xx00. Only the lower four address bits are used by the device, and the upper four bits are don't cares. The 24xx00 will acknowledge the address byte and the master device will then transmit the data word to be written into the addressed memory location. The 24xx00 acknowledges again and the master generates a stop condition. This initiates the internal write cycle, and during this time the 24xx00 will not generate acknowledge signals (Figure 7-2). After a byte write command, the internal address counter will not be incremented and will point to the same address location that was just written. If a stop bit is transmitted to the device at any point in the write command sequence before the entire sequence is complete, then the command will abort and no data will be written. If more than 8 data bits are transmitted before the stop bit is sent, then the device will clear the previously loaded byte and begin loading the data buffer again. If more than one data byte is transmitted to the device and a stop bit is sent before a full eight data bits have been transmitted, then the write command will abort and no data will be written. The 24xx00 employs a Vcc threshold detector circuit which disables the internal erase/write logic if the Vcc is below 1.5V (24AA00 and 24LC00) or 3.8V (24C00) at nominal conditions.

## 7.0 ACKNOWLEDGE POLLING

Since the device will not acknowledge during a write cycle, this can be used to determine when the cycle is complete (this feature can be used to maximize bus throughput). Once the stop condition for a write command has been issued from the master, the device initiates the internally timed write cycle. ACK polling can be initiated immediately. This involves the master sending a start condition followed by the control byte for a write command (R/W = 0). If the device is still busy with the write cycle, then no ACK will be returned. If no ACK is returned, then the start bit and control byte must be re-sent. If the cycle is complete, then the device will return the ACK and the master can then proceed with the next read or write command. See Figure 7-1 for flow diagram.

**FIGURE 7-1: ACKNOWLEDGE POLLING FLOW**

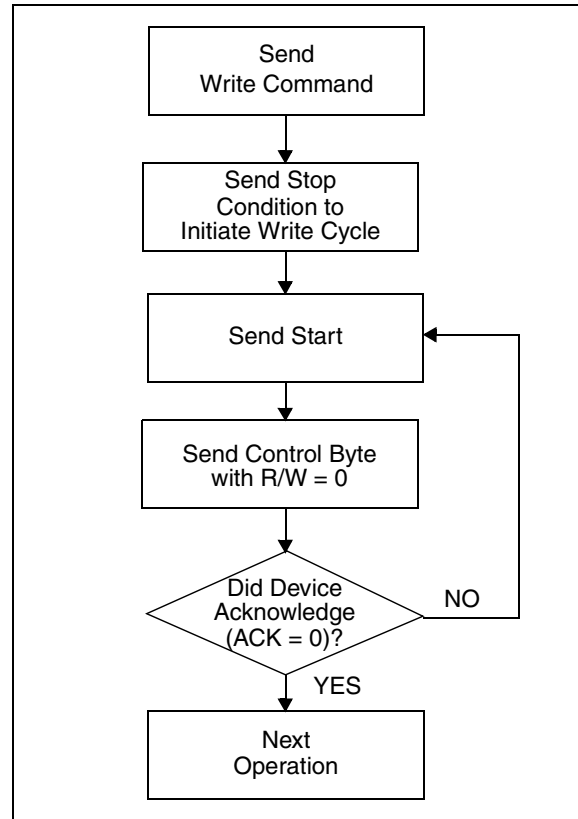

**FIGURE 7-2: BYTE WRITE**

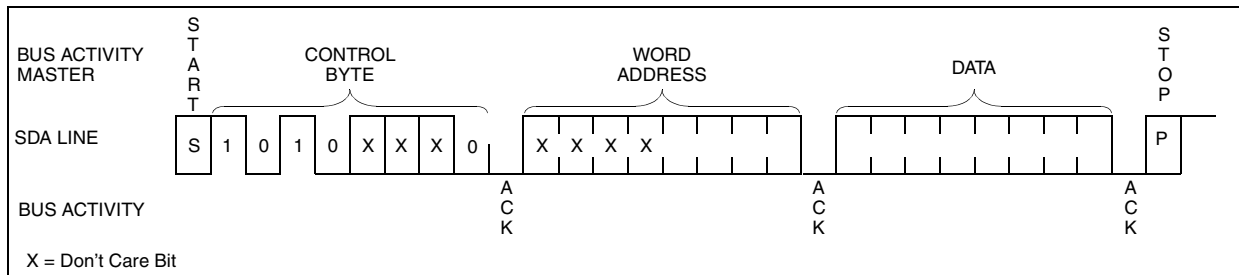

## 8.0 READ OPERATIONS

Read operations are initiated in the same way as write operations with the exception that the R/W bit of the slave address is set to one. There are three basic types of read operations: current address read, random read, and sequential read.

### 8.1 Current Address Read

The 24xx00 contains an address counter that maintains the address of the last word accessed, internally incremented by one. Therefore, if the previous read access was to address  $n$ , the next current address read operation would access data from address  $n + 1$ . Upon receipt of the slave address with the R/W bit set to one, the device issues an acknowledge and transmits the eight bit data word. The master will not acknowledge the transfer but does generate a stop condition and the device discontinues transmission (Figure 8-1).

### 8.2 Random Read

Random read operations allow the master to access any memory location in a random manner. To perform this type of read operation, first the word address must be set. This is done by sending the word address to the

device as part of a write operation. After the word address is sent, the master generates a start condition following the acknowledge. This terminates the write operation, but not before the internal address pointer is set. Then the master issues the control byte again but with the R/W bit set to a one. The 24xx00 will then issue an acknowledge and transmits the eight bit data word. The master will not acknowledge the transfer but does generate a stop condition and the device discontinues transmission (Figure 8-2). After this command, the internal address counter will point to the address location following the one that was just read.

### 8.3 Sequential Read

Sequential reads are initiated in the same way as a random read except that after the device transmits the first data byte, the master issues an acknowledge as opposed to a stop condition in a random read. This directs the device to transmit the next sequentially addressed 8-bit word (Figure 8-3).

To provide sequential reads the 24xx00 contains an internal address pointer which is incremented by one at the completion of each read operation. This address pointer allows the entire memory contents to be serially read during one operation.

**FIGURE 8-1: CURRENT ADDRESS READ**

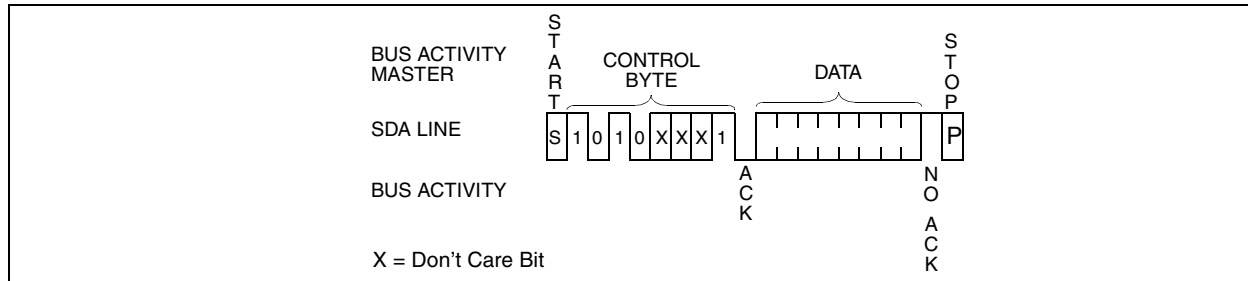

**FIGURE 8-2: RANDOM READ**

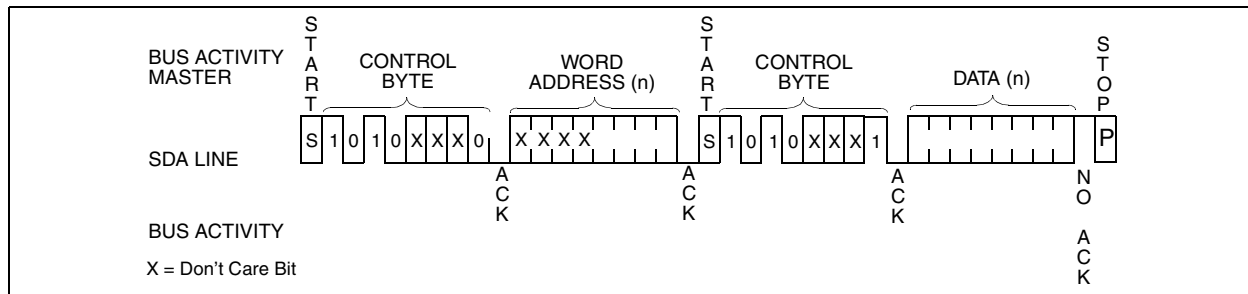

**FIGURE 8-3: SEQUENTIAL READ**

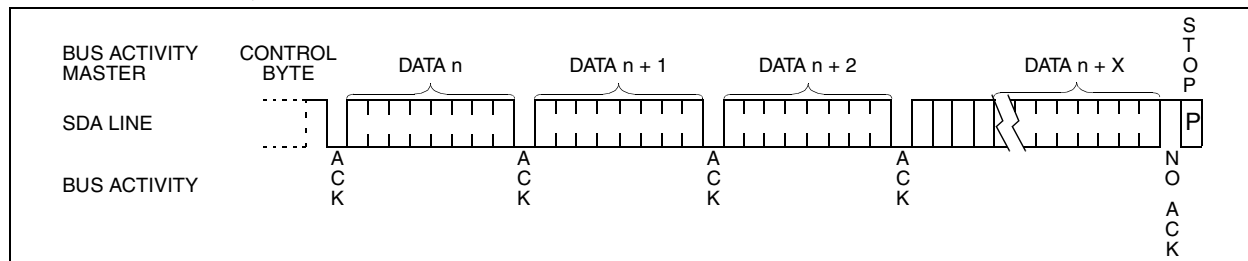



NOTES:

# 24AA00/24LC00/24C00

## 24XX00 PRODUCT IDENTIFICATION SYSTEM

To order or obtain information, e.g., on pricing or delivery, refer to the factory or the listed sales office.

<b>24xx00</b> —	<b>/P</b>		
		<b>Package:</b>	P = Plastic DIP (300 mil Body), 8-lead SN = Plastic SOIC (150 mil Body) ST = TSSOP, 8-lead OT = SOT-23, 5-lead
		<b>Temperature Range:</b>	Blank = 0°C to +70°C I = -40°C to +85°C E = -40°C to +125°C
		<b>Device:</b>	24AA00 128 bit 1.8V I <sup>2</sup> C Serial EEPROM 24AA00T 128 bit 1.8V I <sup>2</sup> C Serial EEPROM (Tape and Reel) 24LC00 128 bit 2.5V I <sup>2</sup> C Serial EEPROM 24LC00T 128 bit 2.5V I <sup>2</sup> C Serial EEPROM (Tape and Reel) 24C00 128 bit 5.0V I <sup>2</sup> C Serial EEPROM 24C00T 128 bit 5.0V I <sup>2</sup> C Serial EEPROM (Tape and Reel)

### Sales and Support

#### **Data Sheets**

Products supported by a preliminary Data Sheet may have an errata sheet describing minor operational differences and recommended workarounds. To determine if an errata sheet exists for a particular device, please contact one of the following:

1. Your local Microchip sales office
2. The Microchip Corporate Literature Center U.S. FAX: (602) 786-7277
3. The Microchip Worldwide Web Site ([www.microchip.com](http://www.microchip.com))



## WORLDWIDE SALES AND SERVICE

### AMERICAS

#### Corporate Office

Microchip Technology Inc.  
2355 West Chandler Blvd.  
Chandler, AZ 85224-6199  
Tel: 480-786-7200 Fax: 480-786-7277  
Technical Support: 480-786-7627  
Web Address: <http://www.microchip.com>

#### Atlanta

Microchip Technology Inc.  
500 Sugar Mill Road, Suite 200B  
Atlanta, GA 30350  
Tel: 770-640-0034 Fax: 770-640-0307

#### Boston

Microchip Technology Inc.  
5 Mount Royal Avenue  
Marlborough, MA 01752  
Tel: 508-480-9990 Fax: 508-480-8575

#### Chicago

Microchip Technology Inc.  
333 Pierce Road, Suite 180  
Itasca, IL 60143  
Tel: 630-285-0071 Fax: 630-285-0075

#### Dallas

Microchip Technology Inc.  
4570 Westgrove Drive, Suite 160  
Addison, TX 75248  
Tel: 972-818-7423 Fax: 972-818-2924

#### Dayton

Microchip Technology Inc.  
Two Prestige Place, Suite 150  
Miamisburg, OH 45342  
Tel: 937-291-1654 Fax: 937-291-9175

#### Detroit

Microchip Technology Inc.  
Tri-Atria Office Building  
32255 Northwestern Highway, Suite 190  
Farmington Hills, MI 48334  
Tel: 248-538-2250 Fax: 248-538-2260

#### Los Angeles

Microchip Technology Inc.  
18201 Von Karman, Suite 1090  
Irvine, CA 92612  
Tel: 949-263-1888 Fax: 949-263-1338

#### New York

Microchip Technology Inc.  
150 Motor Parkway, Suite 202  
Hauppauge, NY 11788  
Tel: 631-273-5305 Fax: 631-273-5335

#### San Jose

Microchip Technology Inc.  
2107 North First Street, Suite 590  
San Jose, CA 95131  
Tel: 408-436-7950 Fax: 408-436-7955

### AMERICAS (continued)

#### Toronto

Microchip Technology Inc.  
5925 Airport Road, Suite 200  
Mississauga, Ontario L4V 1W1, Canada  
Tel: 905-405-6279 Fax: 905-405-6253

### ASIA/PACIFIC

#### Hong Kong

Microchip Asia Pacific  
Unit 2101, Tower 2  
Metroplaza  
223 Hing Fong Road  
Kwai Fong, N.T., Hong Kong  
Tel: 852-2-401-1200 Fax: 852-2-401-3431

#### Beijing

Microchip Technology, Beijing  
Unit 915, 6 Chaoyangmen Bei Dajie  
Dong Erhuan Road, Dongcheng District  
New China Hong Kong Manhattan Building  
Beijing 100027 PRC  
Tel: 86-10-85282100 Fax: 86-10-85282104

#### India

Microchip Technology Inc.  
India Liaison Office  
No. 6, Legacy, Convent Road  
Bangalore 560 025, India  
Tel: 91-80-229-0061 Fax: 91-80-229-0062

#### Japan

Microchip Technology Intl. Inc.  
Benex S-1 6F  
3-18-20, Shinyokohama  
Kohoku-Ku, Yokohama-shi  
Kanagawa 222-0033 Japan  
Tel: 81-45-471-6166 Fax: 81-45-471-6122

#### Korea

Microchip Technology Korea  
168-1, Youngbo Bldg. 3 Floor  
Samsung-Dong, Kangnam-Ku  
Seoul, Korea  
Tel: 82-2-554-7200 Fax: 82-2-558-5934

#### Shanghai

Microchip Technology  
RM 406 Shanghai Golden Bridge Bldg.  
2077 Yan'an Road West, Hong Qiao District  
Shanghai, PRC 200335  
Tel: 86-21-6275-5700 Fax: 86 21-6275-5060

### ASIA/PACIFIC (continued)

#### Singapore

Microchip Technology Singapore Pte Ltd.  
200 Middle Road  
#07-02 Prime Centre  
Singapore 188980  
Tel: 65-334-8870 Fax: 65-334-8850

#### Taiwan, R.O.C

Microchip Technology Taiwan  
10F-1C 207  
Tung Hua North Road  
Taipei, Taiwan, ROC  
Tel: 886-2-2717-7175 Fax: 886-2-2545-0139

### EUROPE

#### United Kingdom

Arizona Microchip Technology Ltd.  
505 Eskdale Road  
Wokingham  
Berkshire, England RG41 5TU  
Tel: 44 118 921 5858 Fax: 44-118 921-5835

#### Denmark

Microchip Technology Denmark ApS  
Regus Business Centre  
Lautrup hof 1-3  
Ballerup DK-2750 Denmark  
Tel: 45 4420 9895 Fax: 45 4420 9910

#### France

Arizona Microchip Technology SARL  
Parc d'Activite du Moulin de Massy  
43 Rue du Saule Trapu  
Batiment A - 1er Etage  
91300 Massy, France  
Tel: 33-1-69-53-63-20 Fax: 33-1-69-30-90-79

#### Germany

Arizona Microchip Technology GmbH  
Gustav-Heinemann-Ring 125  
D-81739 München, Germany  
Tel: 49-89-627-144 0 Fax: 49-89-627-144-44

#### Italy

Arizona Microchip Technology SRL  
Centro Direzionale Colleoni  
Palazzo Taurus 1 V. Le Colleoni 1  
20041 Agrate Brianza  
Milan, Italy  
Tel: 39-039-65791-1 Fax: 39-039-6899883

11/15/99

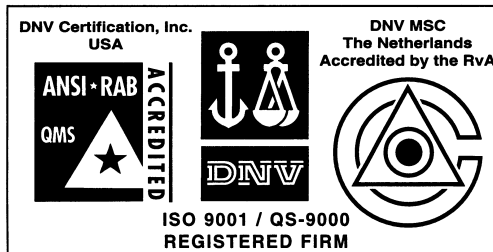

Microchip received QS-9000 quality system certification for its worldwide headquarters, design and water fabrication facilities in Chandler and Tempe, Arizona in July 1999. The Company's quality system processes and procedures are QS-9000 compliant for its PICmicro® 8-bit MCUs, KEELOC® code hopping devices, Serial EEPROMs and microperipheral products. In addition, Microchip's quality system for the design and manufacture of development systems is ISO 9001 certified.

All rights reserved. © 1999 Microchip Technology Incorporated. Printed in the USA. 11/99 Printed on recycled paper.

Information contained in this publication regarding device applications and the like is intended for suggestion only and may be superseded by updates. No representation or warranty is given and no liability is assumed by Microchip Technology Incorporated with respect to the accuracy or use of such information, or infringement of patents or other intellectual property rights arising from such use or otherwise. Use of Microchip's products as critical components in life support systems is not authorized except with express written approval by Microchip. No licenses are conveyed, implicitly or otherwise, under any intellectual property rights. The Microchip logo and name are registered trademarks of Microchip Technology Inc. in the U.S.A. and other countries. All rights reserved. All other trademarks mentioned herein are the property of their respective companies.