

GE2761

N-CHANNEL ENHANCEMENT MODE POWER MOSFET

BV _{DSS}	600/650V
R _{DS(ON)}	1.0Ω
I _D	10A

Description

The GE2761 series provide the designer with best combination of fast switching, ruggedized device design, low on-resistance and cost-effectiveness.

The through-hole version (TO-220) is available for low-profile applications and suited for low voltage applications such as DC/DC converters.

Features

- *Low On-resistance
- *Simple Drive Requirement
- *RoHS Compliant
- *Fast Switching Characteristic

Package Dimensions

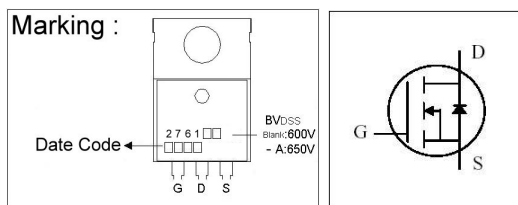
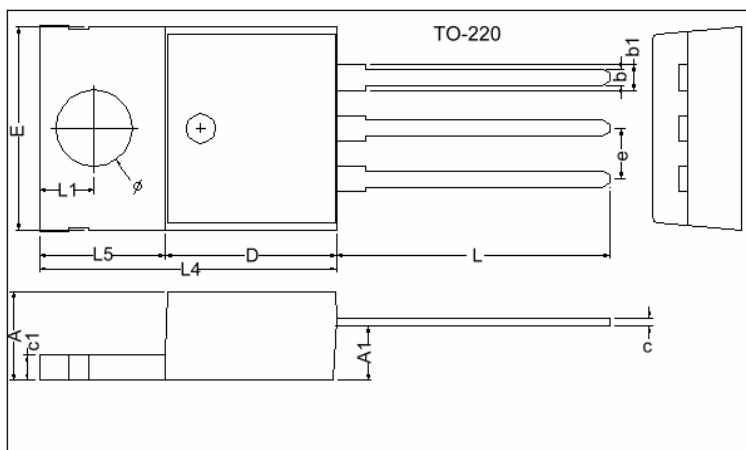

REF.	Millimeter		REF.	Millimeter	
	Min.	Max.		Min.	Max.
A	4.40	4.80	c1	1.25	1.45
b	0.76	1.00	b1	1.17	1.47
c	0.36	0.50	L	13.25	14.25
D	8.60	9.00	e	2.54 REF.	
E	9.80	10.4	L1	2.60	2.89
L4	14.7	15.3	∅	3.71	3.96
L5	6.20	6.60	A1	2.60	2.80

Absolute Maximum Ratings

Parameter	Symbol	Ratings	Unit	
Drain-Source Voltage	- /A	V _{DS}	600/650	V
Gate-Source Voltage		V _{GS}	±30	V
Continuous Drain Current, V _{GS} @10V	I _D @T _C =25°C	10	A	
Continuous Drain Current, V _{GS} @10V	I _D @T _C =100°C	4.4	A	
Pulsed Drain Current ¹	I _{DM}	18	A	
Total Power Dissipation	P _D @T _C =25°C	104	W	
Linear Derating Factor		0.8	W/°C	
Avalanche Current	I _{AR}	10	A	
Operating Junction and Storage Temperature Range	T _j , T _{stg}	-55 ~ +150	°C	

Thermal Data

Parameter	Symbol	Value	Unit
Thermal Resistance Junction-case	R _{thj-c}	1.2	°C/W
Thermal Resistance Junction-ambient	R _{thj-a}	62	°C/W

Electrical Characteristics(T_j = 25°C Unless otherwise specified)

Parameter	Symbol	Min.	Typ.	Max.	Unit	Test Conditions
Drain-Source Breakdown Voltage	BV _{DSS}	600	-	-	V	V _{GS} =0, I _D =250uA -
		650	-	-	V	V _{GS} =0, I _D =250uA A
Breakdown Voltage Temperature Coefficient	ΔBV _{DSS} /ΔT _j	-	0.6	-	V/°C	Reference to 25°C, I _D =1mA
Gate Threshold Voltage	V _{GS(th)}	2.0	-	4.0	V	V _{DS} =V _{GS} , I _D =250uA
Forward Transconductance	g _{fs}	-	4.5	-	S	V _{DS} =10V, I _D =3.5A
Gate-Source Leakage Current	I _{GSS}	-	-	±100	nA	V _{GS} = ±30V
Drain-Source Leakage Current(T _j =25°C)	I _{DSS}	-	-	10	uA	V _{DS} =600V, V _{GS} =0
Drain-Source Leakage Current(T _j =150°C)		-	-	100	uA	V _{DS} =480V, V _{GS} =0
Static Drain-Source On-Resistance	R _{DS(ON)}	-	-	1.0	Ω	V _{GS} =10V, I _D =3.5A
Total Gate Charge ³	Q _g	-	53	85	nC	I _D =10A V _{DS} =520V V _{GS} =10V
Gate-Source Charge	Q _{gs}	-	10	-		
Gate-Drain ("Miller") Change	Q _{gd}	-	15	-		
Turn-on Delay Time ³	T _{d(on)}	-	16	-	Ns	V _{DD} =320V I _D =10A V _{GS} =10V R _G =10Ω R _D =30Ω
Rise Time	T _r	-	20	-		
Turn-off Delay Time	T _{d(off)}	-	82	-		
Fall Time	T _f	-	36	-		
Input Capacitance	C _{iss}	-	2770	4430	pF	V _{GS} =0V V _{DS} =15V f=1.0MHz
Output Capacitance	C _{oss}	-	320	-		
Reverse Transfer Capacitance	C _{rss}	-	8	-		

Source-Drain Diode

Parameter	Symbol	Min.	Typ.	Max.	Unit	Test Conditions
Forward On Voltage ³	V _{SD}	-	-	1.5	V	I _S =10A, V _{GS} =0V, T _j =25°C
Reverse Recovery Time ³	T _{rr}	-	610	-	ns	I _S =10A, V _{GS} =0V di/dt=100A/μs
Reverse Recovery Charge	Q _{rr}	-	8.64	-	uC	

Notes: 1. Pulse width limited by safe operating area.

2. Staring T_j=25°C, V_{DD}=50V, L=1.2mH, R_G=25Ω, I_{AS}=10A.

3. Pulse width ≤ 300us, duty cycle ≤ 2%.

Characteristics Curve

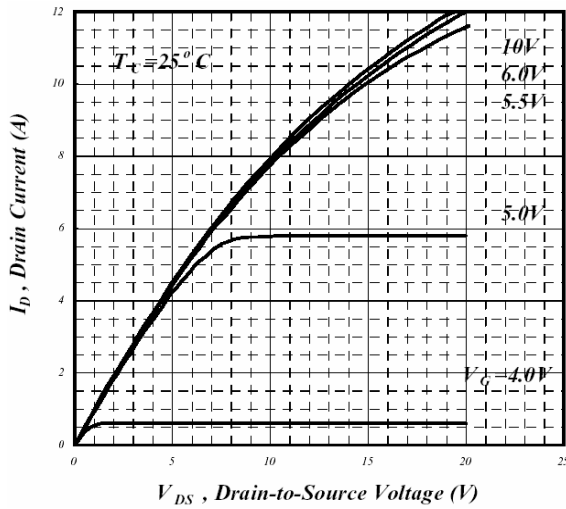

Fig 1. Typical Output Characteristics

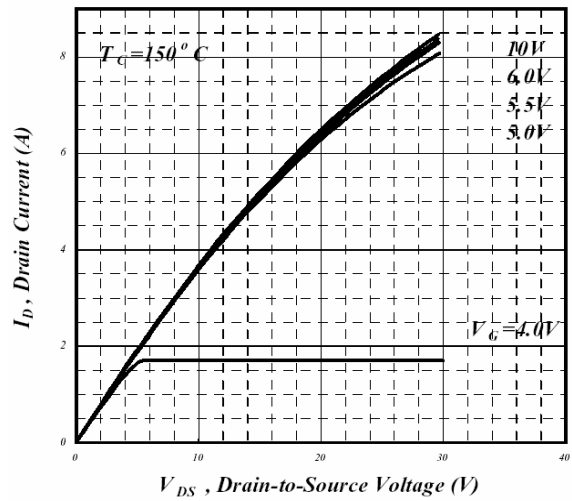

Fig 2. Typical Output Characteristics

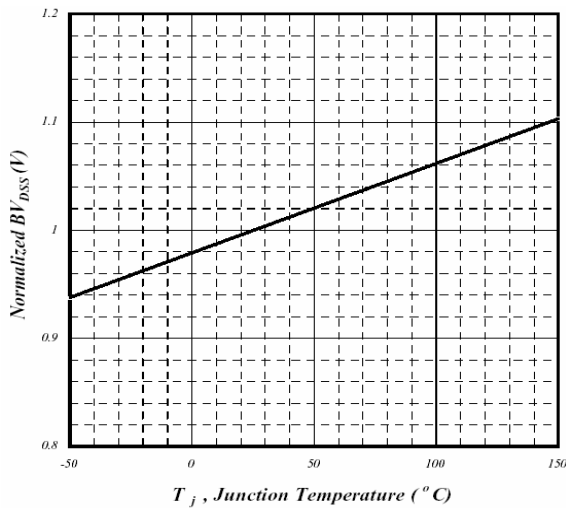

Fig 3. Normalized BV_{DSS} v.s. Junction Temperature

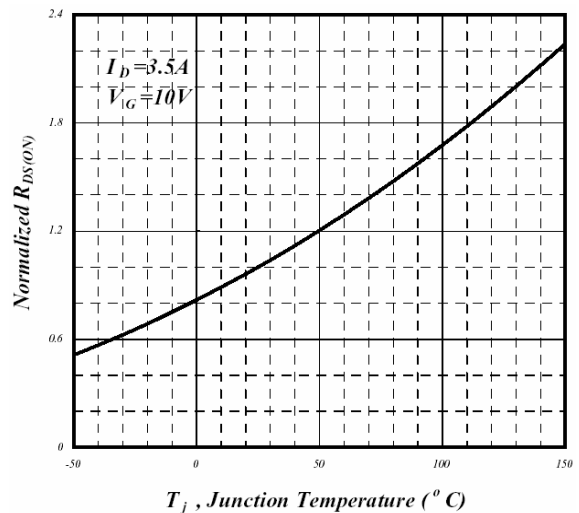

Fig 4. Normalized On-Resistance v.s. Junction Temperature

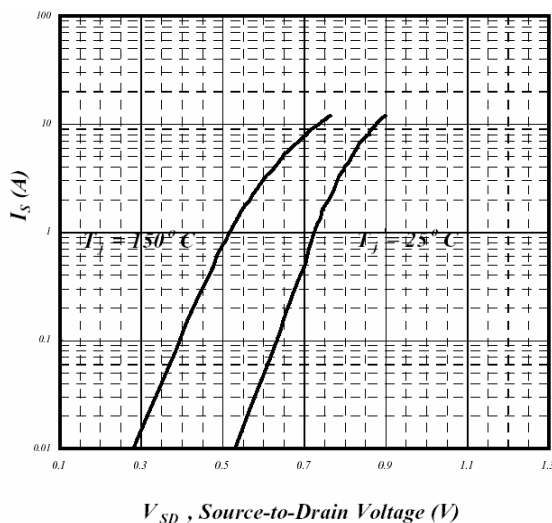

Fig 5. Forward Characteristics of Reverse Diode

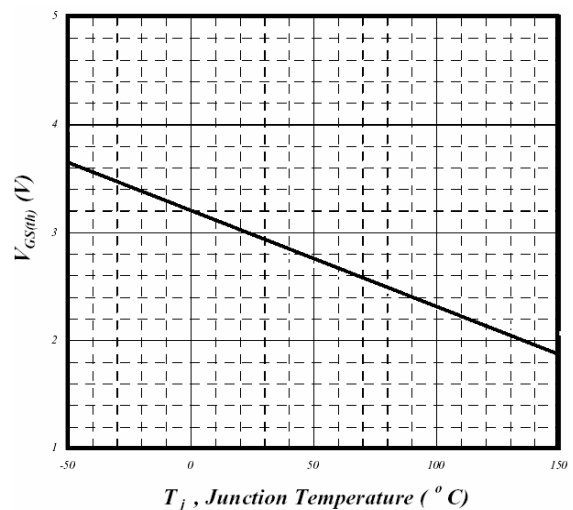

Fig 6. Gate Threshold Voltage v.s. Junction Temperature

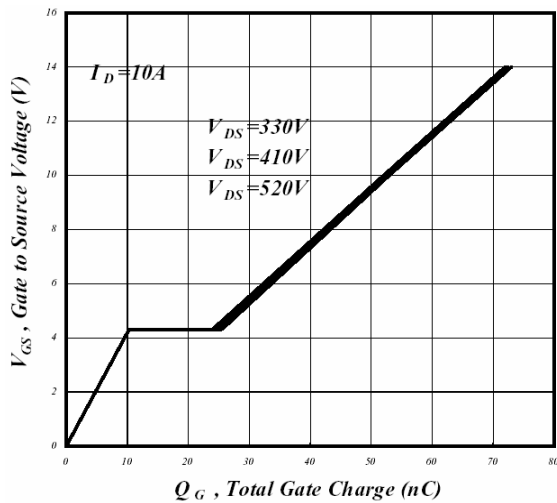

Fig 7. Gate Charge Characteristics

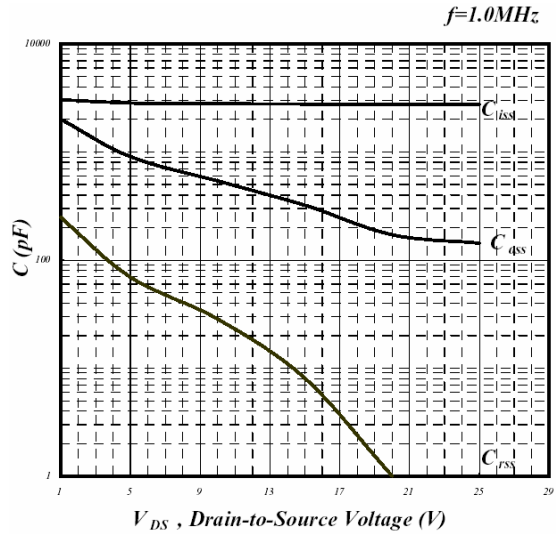

Fig 8. Typical Capacitance Characteristics

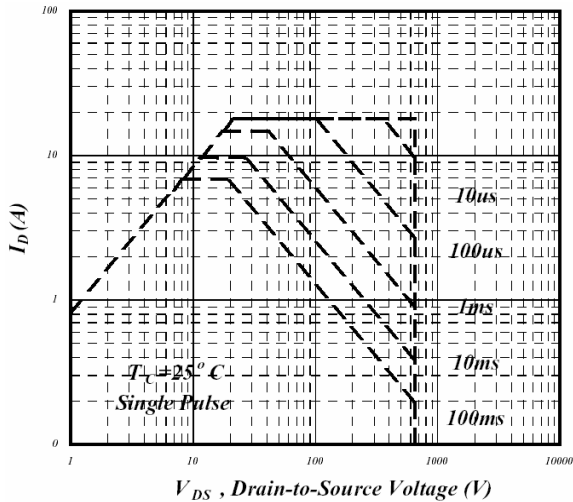

Fig 9. Maximum Safe Operating Area

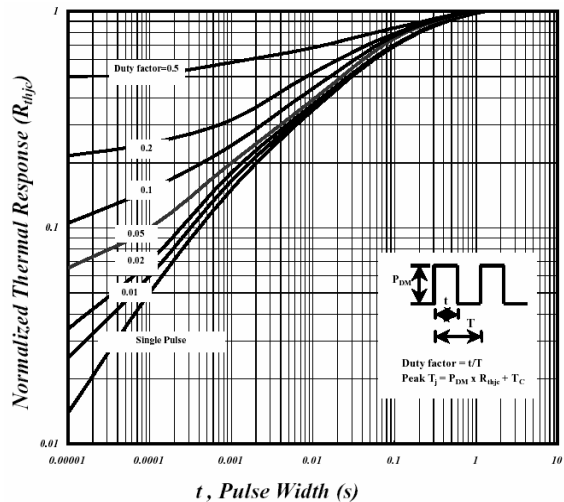

Fig 10. Effective Transient Thermal Impedance

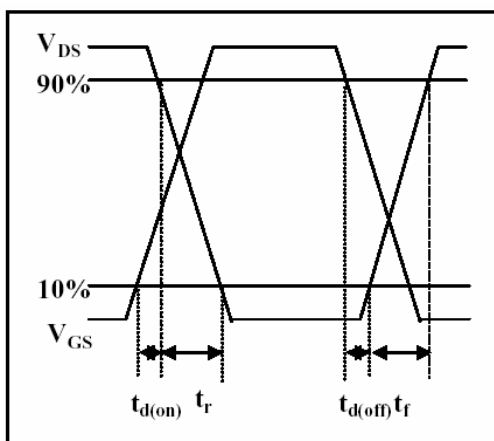

Fig 11. Switching Time Waveform

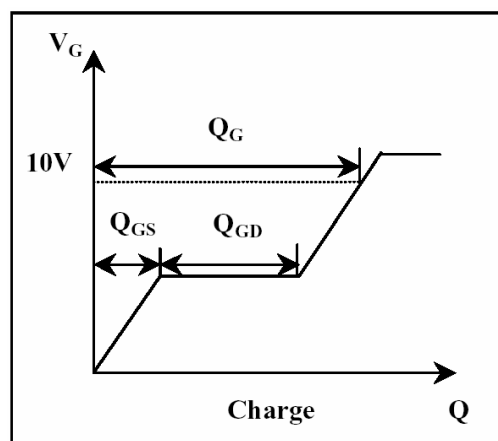

Fig 12. Gate Charge Waveform

Important Notice:

- All rights are reserved. Reproduction in whole or in part is prohibited without the prior written approval of GTM.
- GTM reserves the right to make changes to its products without notice.
- GTM semiconductor products are not warranted to be suitable for use in life-support Applications, or systems.
- GTM assumes no liability for any consequence of customer product design, infringement of patents, or application assistance.

Head Office And Factory:

- Taiwan:** No. 17-1 Tatung Rd. Fu Kou Hsin-Chu Industrial Park, Hsin-Chu, Taiwan, R. O. C.
- TEL : 886-3-597-7061 FAX : 886-3-597-9220, 597-0785
- China:** (201203) No.255, Jang-Jiang Tsai-Lueng RD. , Pu-Dung-Hsin District, Shang-Hai City, China
- TEL : 86-21-5895-7671 ~ 4 FAX : 86-21-38950165