

FEATURES

- Double internal input matching for easy matching and high gain
- Emitter-ballasting resistors for an optimum temperature profile
- Gold metallization ensures excellent reliability.

DESCRIPTION

Two NPN silicon planar epitaxial transistors in push-pull configuration, intended for linear common emitter class-AB operation in base station transmitters in the 800 to 900 MHz range. The device has double internal input matching.

The transistor is encapsulated in a 4-lead SOT324 flange envelope with a ceramic cap. The flange provides the common emitter connection for both transistors.

PINNING – SOT324

PIN	DESCRIPTION
1	collector 1
2	collector 2
3	base 1
4	base 2
5	emitter (connected to flange)

QUICK REFERENCE DATA

RF performance at $T_n = 25\text{ }^\circ\text{C}$ in a common emitter class-AB push-pull test circuit.

MODE OF OPERATION	f (MHz)	V_{CE} (V)	P_L (W)	G_p (dB)	η_c (%)	d_3 (dBc)
CW, class-AB	900	25	25	≥ 9	≥ 45	–
2-tone, class-AB	900	25	30 (PEP)	≥ 9	≥ 35	≤ -32
2-tone, class-A	900	25	6 (PEP)	typ. 13	–	typ. -43

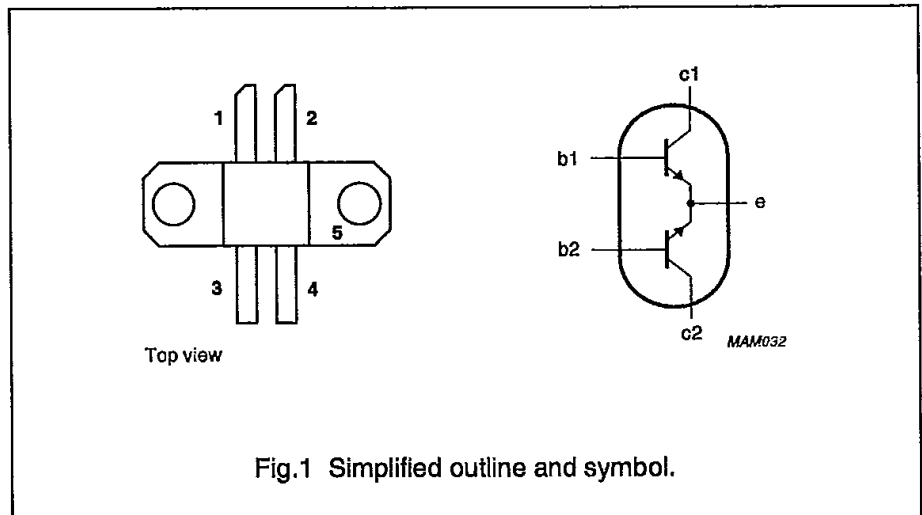

WARNING

Product and environmental safety - toxic materials

This product contains beryllium oxide. The product is entirely safe provided that the BeO disc is not damaged. All persons who handle, use or dispose of this product should be aware of its nature and of the necessary safety precautions. After use, dispose of as chemical or special waste according to the regulations applying at the location of the user. It must never be thrown out with the general or domestic waste.

LIMITING VALUES

In accordance with the Absolute Maximum Rating System (IEC 134).
Per transistor section unless otherwise specified.

SYMBOL	PARAMETER	CONDITIONS	MIN.	MAX.	UNIT
V_{CEO}	collector-emitter voltage	open base	-	27	V
V_{CES}	collector-emitter voltage	$V_{BE} = 0$	-	50	V
V_{EBO}	emitter-base voltage	open collector	-	3.5	V
I_C	DC collector current		-	2	A
$I_{C(AV)}$	average collector current		-	2	A
P_{tot}	total power dissipation	DC; $T_{mb} = 25\text{ °C}$; total device; both sections equally loaded	-	60	W
T_{stg}	storage temperature		-65	150	°C
T_j	junction temperature		-	200	°C

THERMAL RESISTANCE

SYMBOL	PARAMETER	CONDITIONS	THERMAL RESISTANCE
$R_{th\ j-mb}$	thermal resistance from junction to mounting base	$P_{tot} = 60\text{ W}$; $T_{mb} = 25\text{ °C}$; total device; both sections equally loaded	max. 2.9 K/W
$R_{th\ mb-h}$	thermal resistance from mounting base to heatsink	total device; both sections equally loaded	max. 0.5 K/W

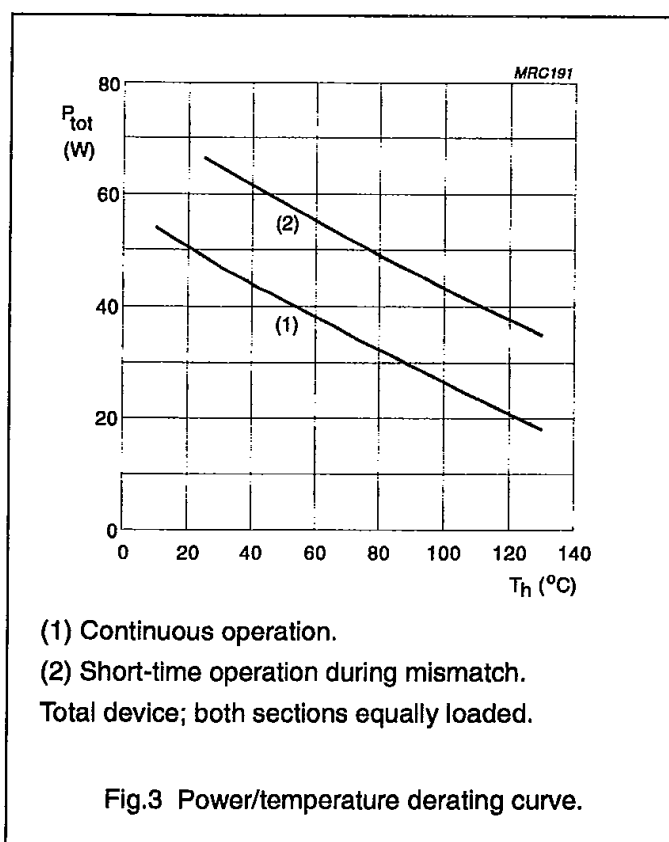
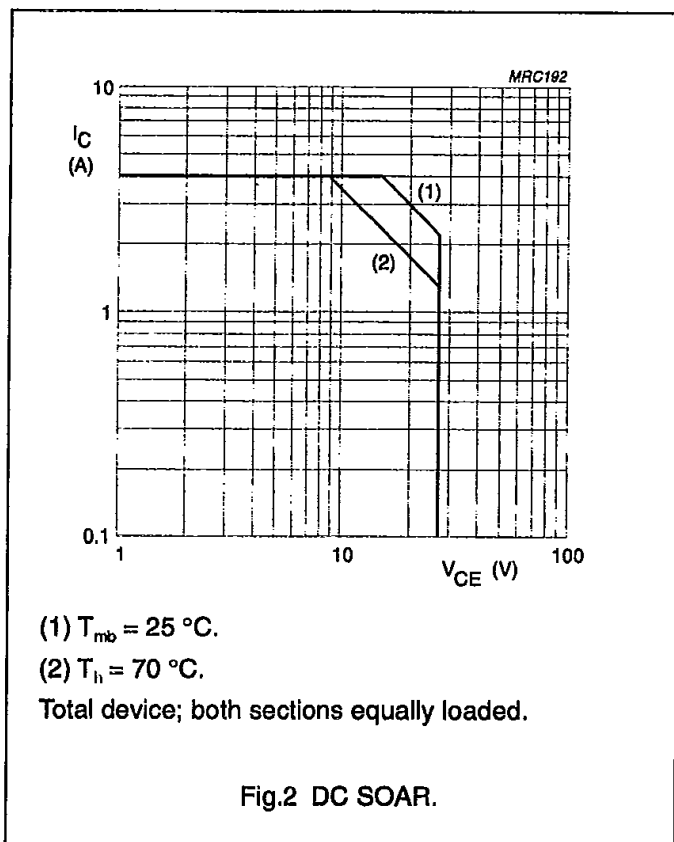

CHARACTERISTICS

$T_j = 25\text{ }^\circ\text{C}$ unless otherwise specified.

Per transistor section unless otherwise specified.

SYMBOL	PARAMETER	CONDITIONS	MIN.	TYP.	MAX.	UNIT
$V_{(BR)CEO}$	collector-emitter breakdown voltage	open base; $I_C = 25\text{ mA}$	27	–	–	V
$V_{(BR)CES}$	collector-emitter breakdown voltage	$I_C = 10\text{ mA}$; $V_{BE} = 0$	50	–	–	V
$V_{(BR)EBO}$	emitter-base breakdown voltage	open collector; $I_E = 5\text{ mA}$	3.5	–	–	V
I_{CES}	collector-emitter cut-off current	$V_{BE} = 0$; $V_{CE} = 27\text{ V}$	–	–	1	mA
h_{FE}	DC current gain	$I_C = 0.85\text{ A}$; $V_{CE} = 25\text{ V}$	30	–	120	
C_c	collector capacitance	$I_E = i_b = 0$; $V_{CB} = 25\text{ V}$; $f = 1\text{ MHz}$	–	24	30	pF

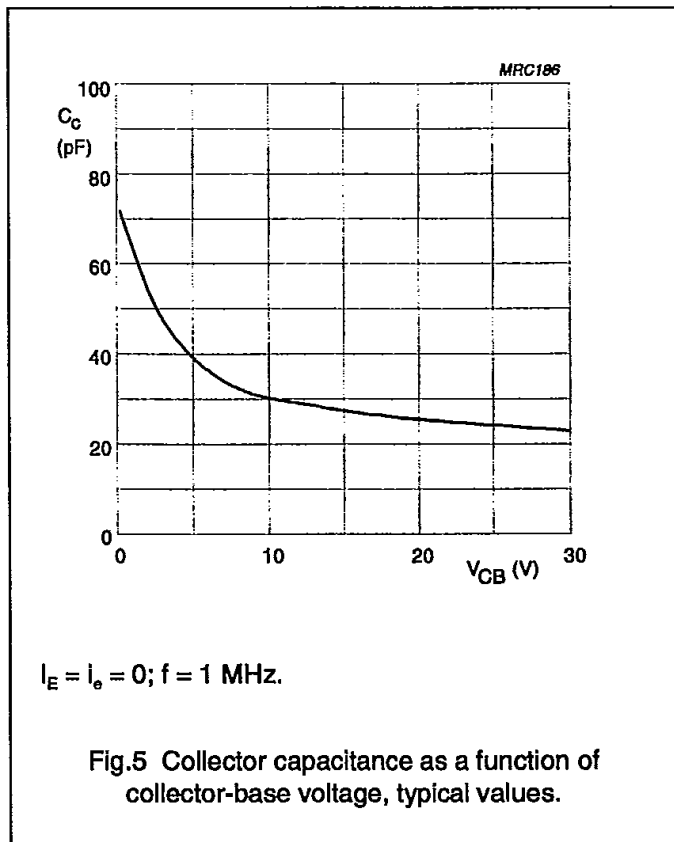
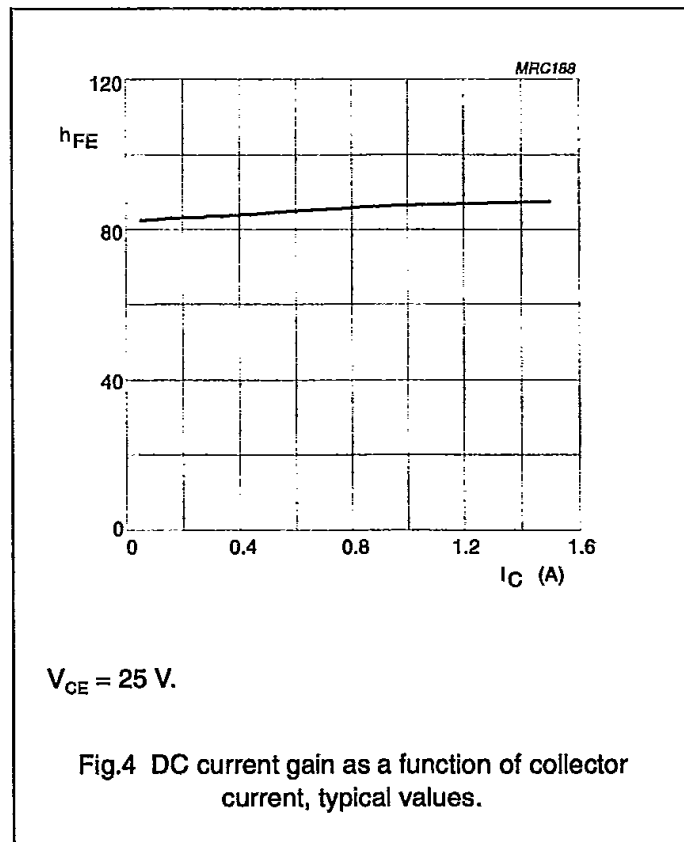

APPLICATION INFORMATION

RF performance in class-AB at $T_h = 25\text{ }^\circ\text{C}$ in a common emitter push-pull test circuit.

$R_{th\text{ mb-h}} = 0.5\text{ K/W}$.

MODE OF OPERATION	f (MHz)	V_{CE} (V)	I_{CQ} (mA)	P_L (W)	G_p (dBc)	η_c (%)	d_3 (dB)
CW, class-AB	900	25	2 x 75	25	≥ 9 typ. 10	≥ 45 typ. 50	—
2-tone, class-AB	900 (note 1)	25	2 x 75	30 (PEP)	≥ 9 typ. 10.5	≥ 35 typ. 40	≤ -32 typ. -36

Note

- $f_1 = 900.0\text{ MHz}$; $f_2 = 900.1\text{ MHz}$.

Ruggedness in class-AB operation

The BLV945A is capable of withstanding a load mismatch corresponding to $V_{SWR} = 3:1$ through all phases under the following conditions: $I_{CQ} = 2 \times 75\text{ mA}$; $V_{CE} = 25\text{ V}$; $T_h = 25\text{ }^\circ\text{C}$; $P_L = 25\text{ W}$; $f = 900\text{ MHz}$.

The BLV945A is capable of withstanding a load mismatch corresponding to $V_{SWR} = 5:1$ through all phases under the following conditions: $I_{CQ} = 2 \times 75\text{ mA}$; $V_{CE} = 25\text{ V}$; $T_h = 25\text{ }^\circ\text{C}$; $P_L = 30\text{ W (PEP)}$; $f_1 = 900.0\text{ MHz}$; $f_2 = 900.1\text{ MHz}$.

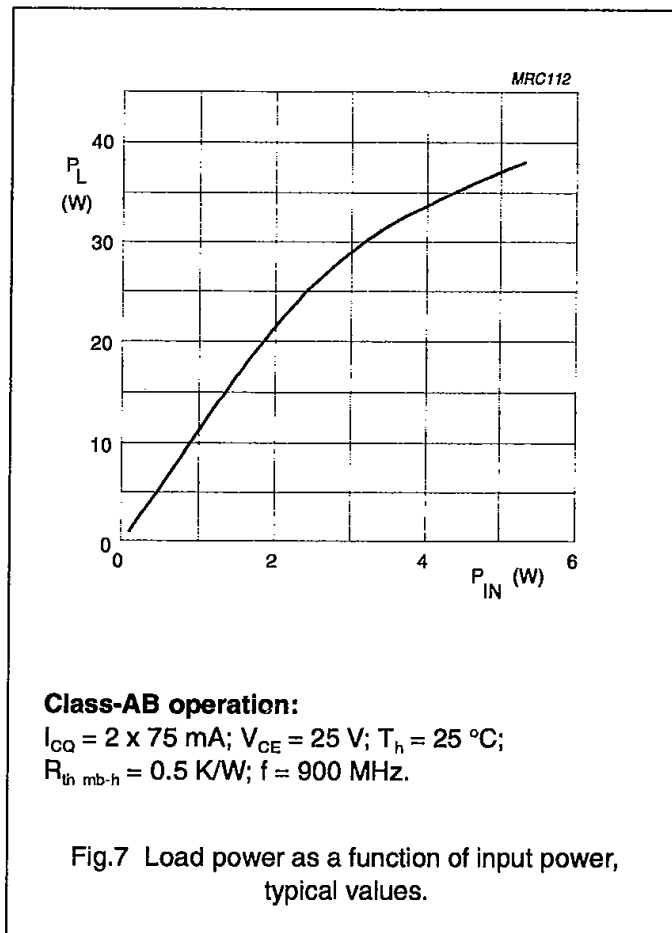
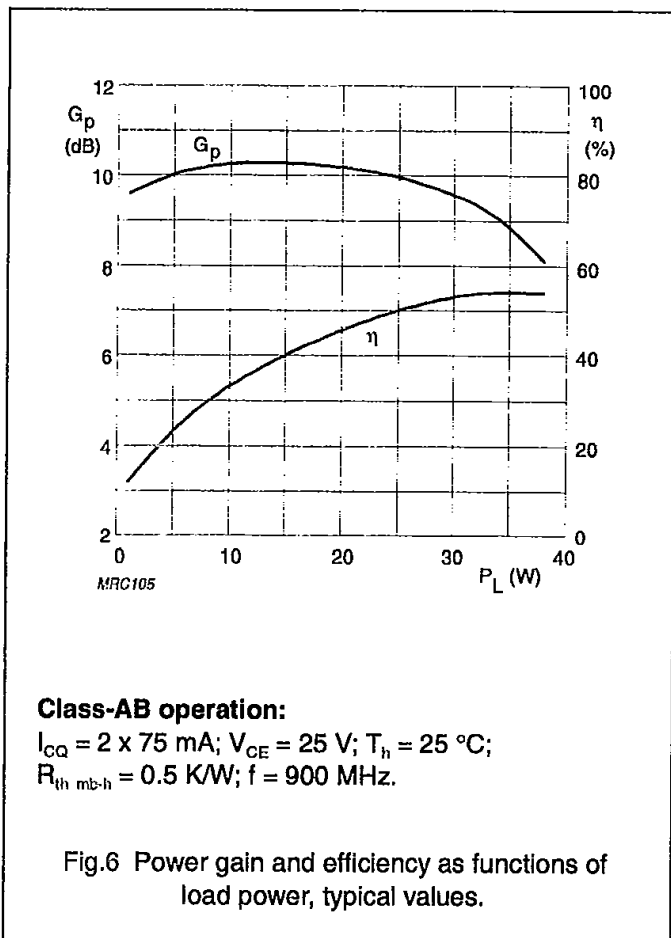

PHILIPS INTERNATIONAL

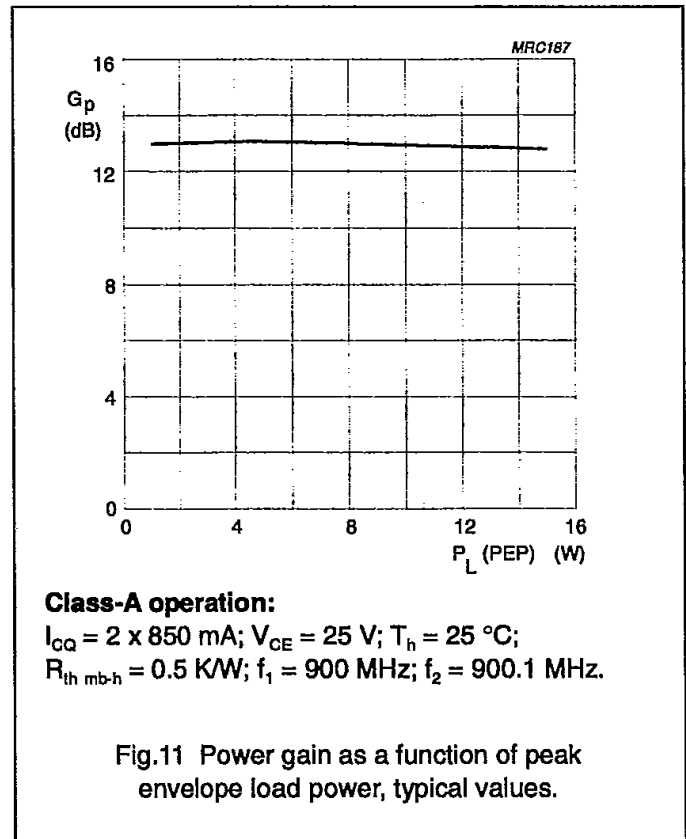
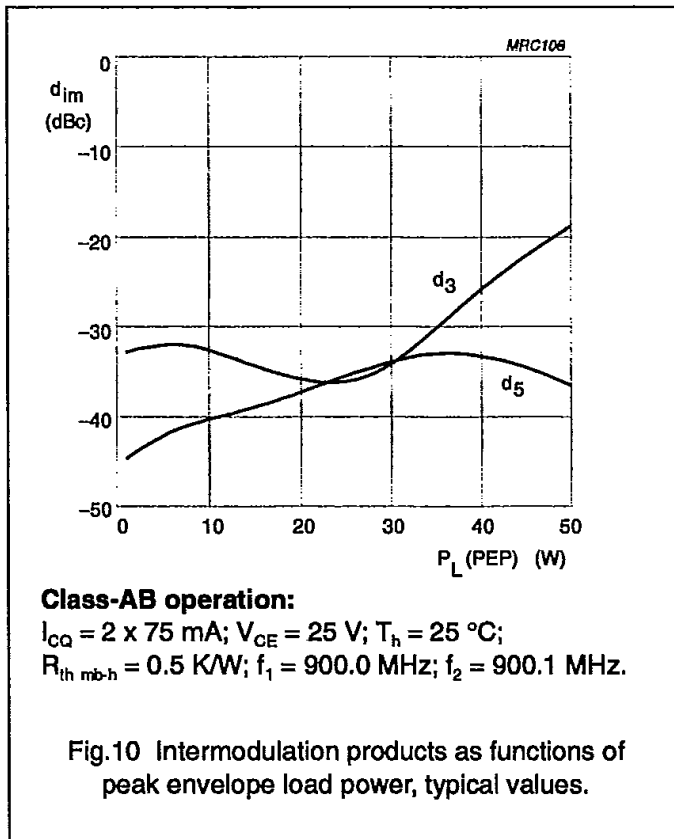
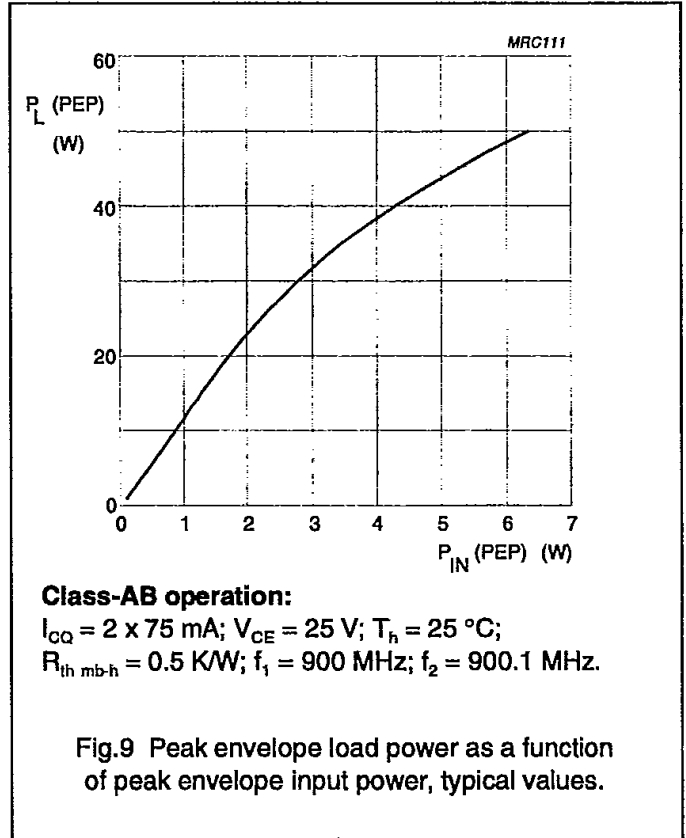
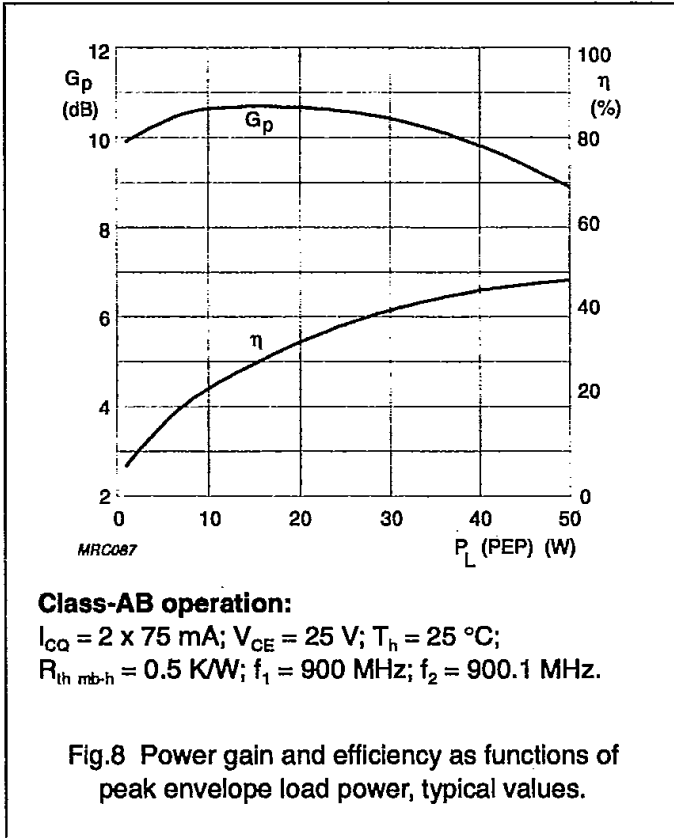

RF performance in class-A at $T_h = 25\text{ }^\circ\text{C}$ in a common emitter push-pull test circuit.

$R_{th\text{ mb-h}} = 0.5\text{ K/W}$.

MODE OF OPERATION	f (MHz)	V_{CE} (V)	I_{CQ} (mA)	P_L (W)	G_p (dB)	d_3 (dBc)
CW, class-A	900 (note 1)	25	2 x 850	6 (PEP)	typ. 13	typ. -43

Note

- $f_1 = 900.0\text{ MHz}$; $f_2 = 900.1\text{ MHz}$.

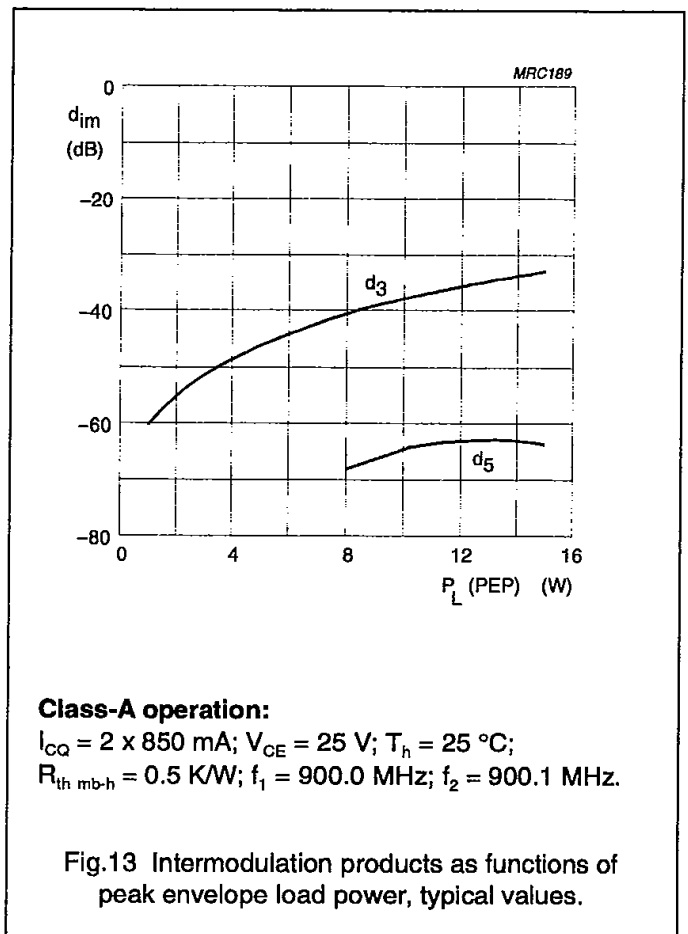
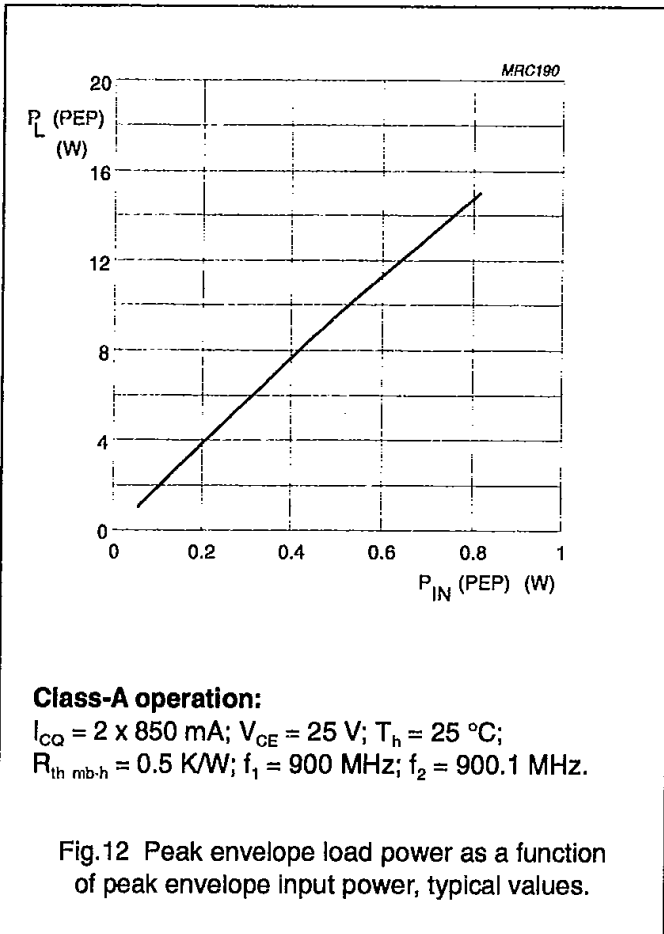

PHILIPS INTERNATIONAL

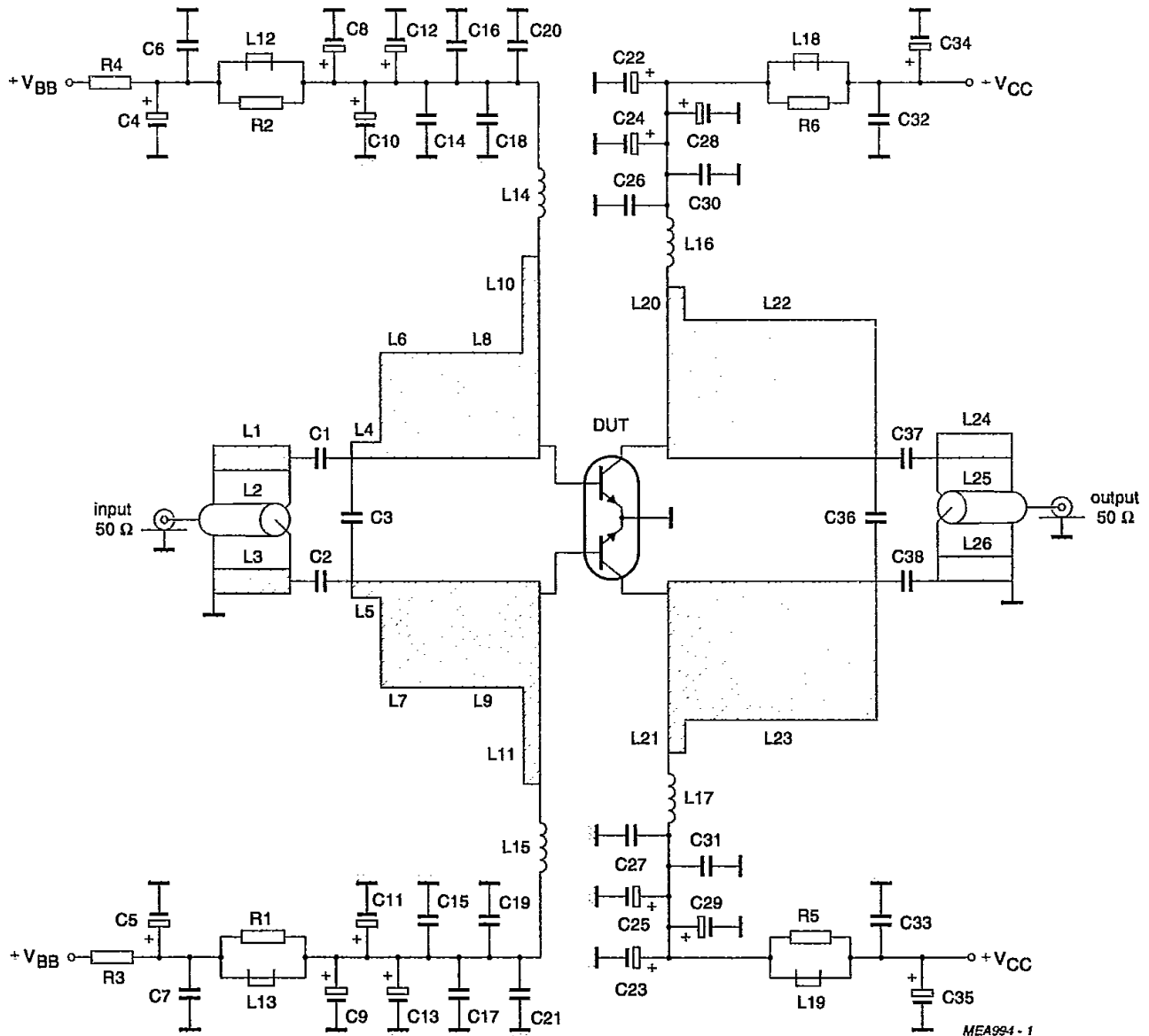

f = 900 MHz.

Fig.14 Class-AB test circuit.

PHILIPS INTERNATIONAL

List of components (see Figs 14 and 15)

COMPONENT	DESCRIPTION	VALUE	DIMENSIONS	CATALOGUE NO.
C1, C2	multilayer ceramic chip capacitor (note 1)	47 pF, 500 V		
C3	multilayer ceramic chip capacitor (note 1)	1 pF, 500 V		
C4, C5, C8, C9, C22, C23, C34, C35	tantalum capacitor	1 μ F, 35 V		2022 019 00056
C6, C7, C18, C19, C30, C31, C32, C33	multilayer ceramic chip capacitor (note 1)	300 pF, 200 V		
C10, C11, C28, C29	tantalum capacitor	2.2 μ F, 35 V		2022 019 00058
C12, C13	electrolytic capacitor	10 μ F, 10 V		2222 085 75109
C14, C15	multilayer ceramic chip capacitor	100 nF, 50 V		2222 581 76641
C16, C17	multilayer ceramic chip capacitor	10 nF, 50 V		2222 581 76627
C20, C21, C26, C27	multilayer ceramic chip capacitor (note 1)	39 pF, 500 V		
C24, C25	electrolytic capacitor	10 μ F, 63 V		2222 030 28109
C36	multilayer ceramic chip capacitor (note 1)	3.3 pF, 500 V		
C37, C38	multilayer ceramic chip capacitor (note 1)	27 pF, 500 V		
L1, L3, L24, L25	stripline (note 2)		length 57.1 mm width 3 mm	
L2, L25	semi-rigid cable (note 3)	50 Ω	length 57.1 mm ext. dia. 2.2 mm	
L4, L5	stripline (note 2)		length 4 mm width 2.5 mm	
L6, L7	stripline (note 2)		length 9 mm width 15 mm	
L8, L9	stripline (note 2)		length 11 mm width 15 mm	
L10, L11	stripline (note 2)		length 3 mm width 31.5 mm	
L12, L13, L18, L19	grade 4S2 Ferroxcube chip bead			4330 030 36300
L14, L15	microchoke	470 nH		4322 057 04771

PHILIPS INTERNATIONAL

List of components (see Figs 14 and 15) (Continued)

COMPONENT	DESCRIPTION	VALUE	DIMENSIONS	CATALOGUE NO.
L16, L17	4 turns enamelled 1 mm copper wire		int. dia. 6 mm close wound	
L20, L21	stripline (note 2)		length 3 mm width 24 mm	
L22, L23	stripline (note 2)		length 27 mm width 20 mm	
R1, R2, R5, R6	metal film resistor	5.11 Ω , 0.4 W		2322 151 75118
R3, R4	metal film resistor	7.5 Ω , 0.4 W		2322 151 77508

Notes

1. American Technical Ceramics (ATC) capacitor, type 100B or other capacitor of the same quality.
2. The striplines are on a double copper-clad printed circuit board, with PTFE microfibre-glass dielectric ($\epsilon_r = 2.2$), thickness $\frac{1}{32}$ inch; thickness of copper sheet $2 \times 35 \mu\text{m}$.
3. Cables soldered to striplines L1 and L26 respectively.

PHILIPS INTERNATIONAL

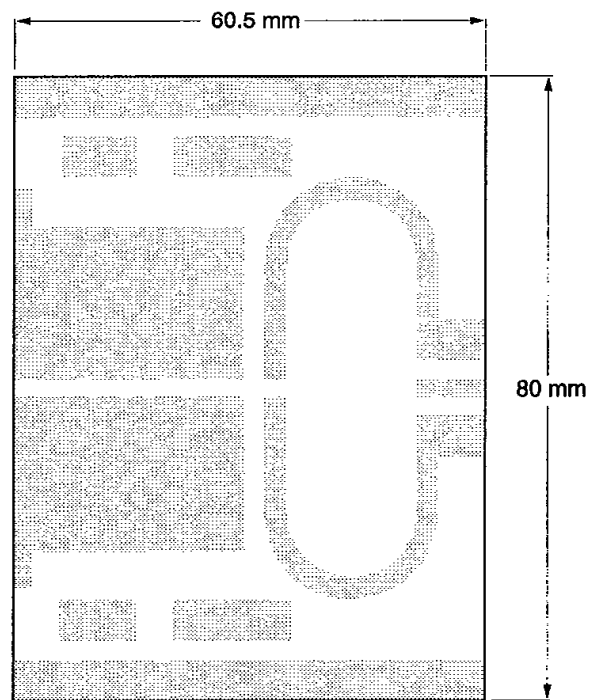
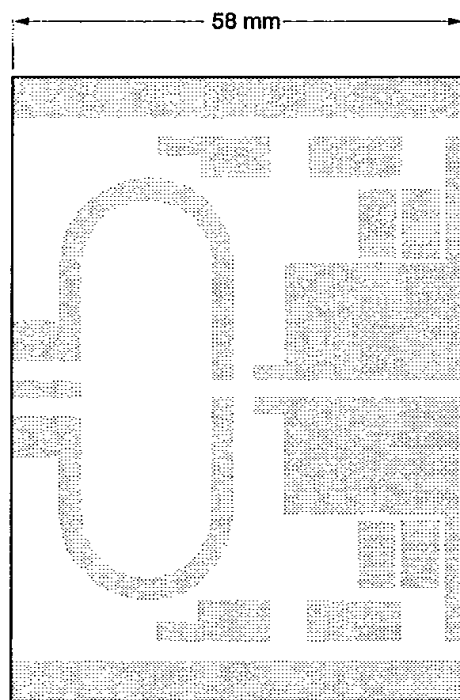
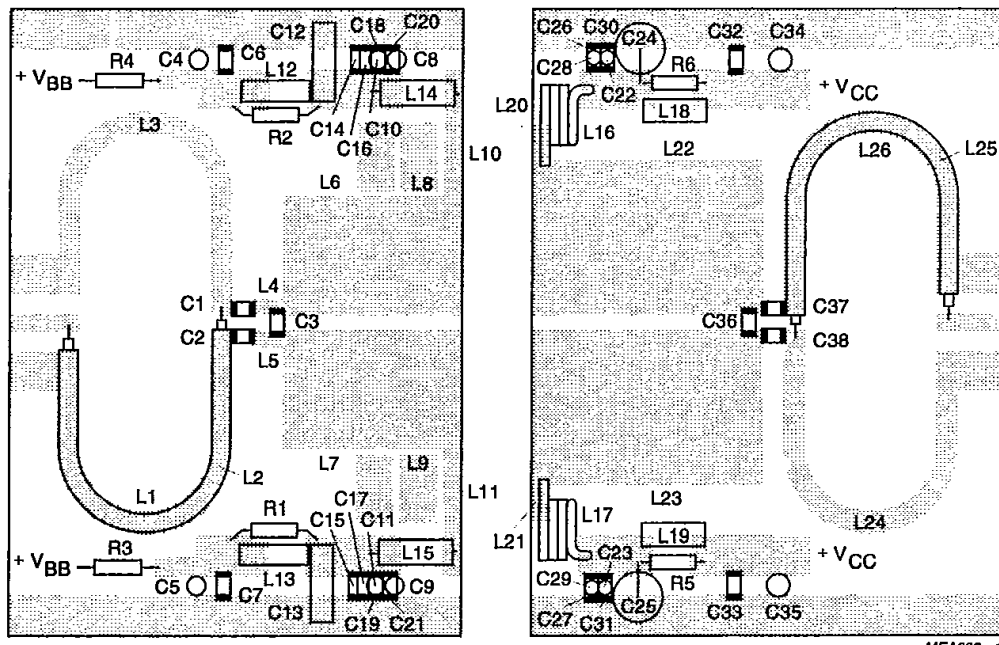

The components are mounted on one side of a copper-clad PTFE microfibre-glass board; the other side is unetched and serves as a ground plane. Earth connections from the component side to the ground plane are made by through metallization.

Fig.15 Component layout for 900 MHz class-AB test circuit.

PHILIPS INTERNATIONAL

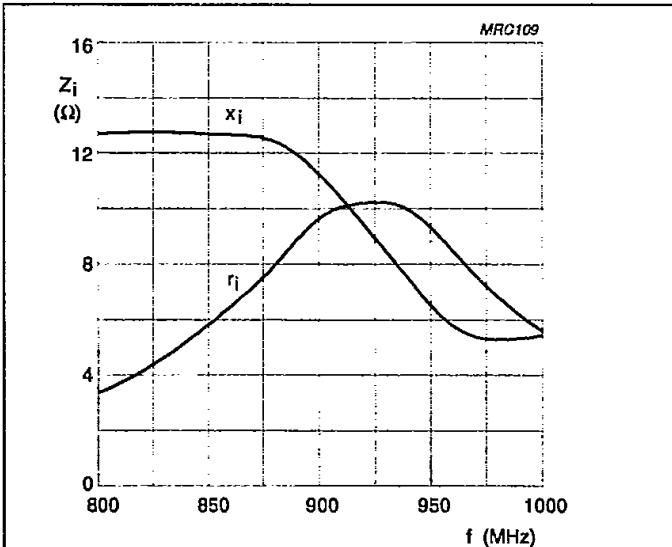

Class-AB operation:

$I_{CQ} = 2 \times 75 \text{ mA}$; $V_{CE} = 25 \text{ V}$; $T_h = 25 \text{ }^\circ\text{C}$;
 $R_{th \text{ mb-h}} = 0.5 \text{ K/W}$; $P_L = 25 \text{ W}$ (total device).

Fig.16 Input impedance as a function of frequency (series components), typical values per section.

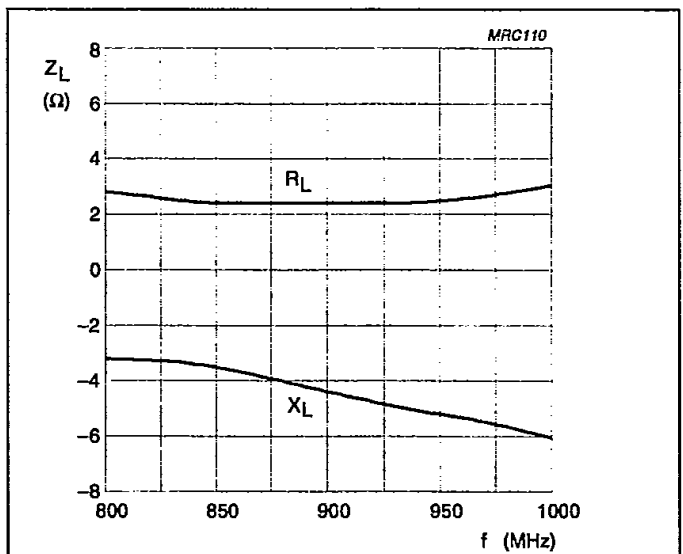

Class-AB operation:

$I_{CQ} = 2 \times 75 \text{ mA}$; $V_{CE} = 25 \text{ V}$; $T_h = 25 \text{ }^\circ\text{C}$;
 $R_{th \text{ mb-h}} = 0.5 \text{ K/W}$; $P_L = 25 \text{ W}$ (total device).

Fig.17 Load impedance as a function of frequency (series components), typical values per section.

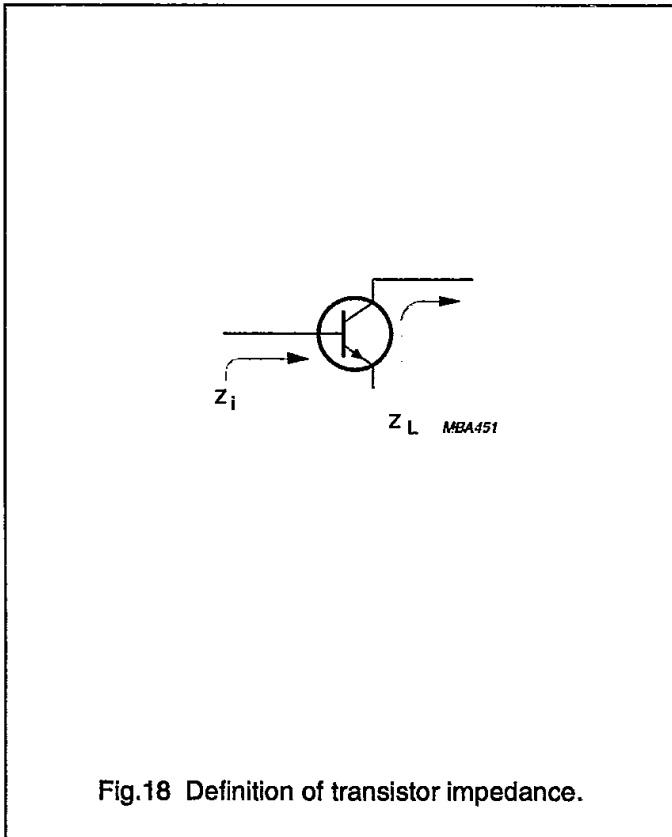
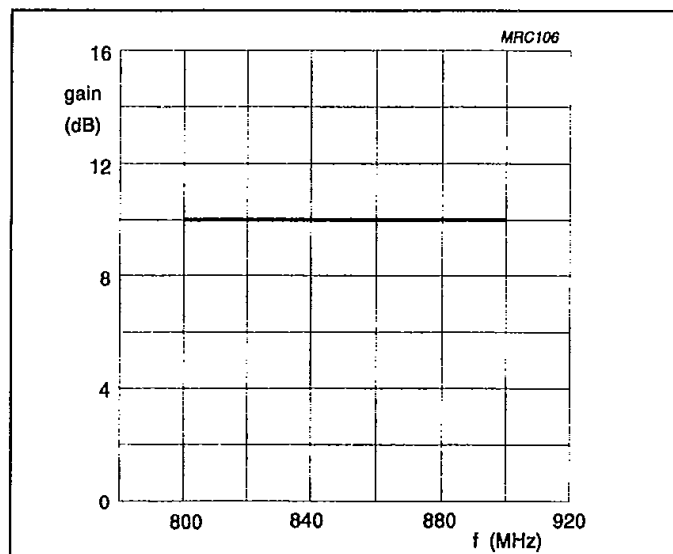

Fig.18 Definition of transistor impedance.

PHILIPS INTERNATIONAL



Class-AB operation:

$I_{CQ} = 2 \times 75 \text{ mA}$; $V_{CE} = 25 \text{ V}$; $T_h = 25 \text{ }^\circ\text{C}$;
 $R_{th \text{ mb-h}} = 0.5 \text{ K/W}$; $P_L = 25 \text{ W}$ (total device).

Fig.19 Gain as a function of frequency, typical values.

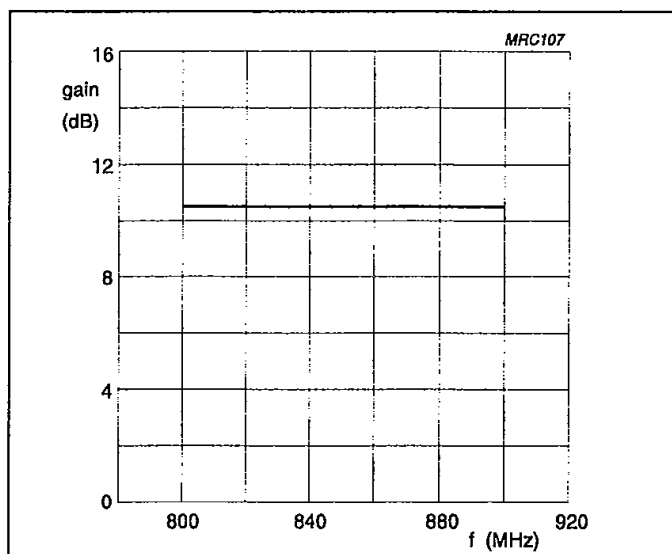

Class-AB operation:

$I_{CQ} = 2 \times 75 \text{ mA}$; $V_{CE} = 25 \text{ V}$; $T_h = 25 \text{ }^\circ\text{C}$;
 $R_{th \text{ mb-h}} = 0.5 \text{ K/W}$; $P_L = 30 \text{ W (PEP)}$ (total device).

Fig.20 Gain as a function of frequency, typical values.