

FEATURES

- Large, 32 × 32, nonblocking switch array**
- G = +1 (ADV3200) or G = +2 (ADV3201) operation**
- Pin-compatible 32 × 16 versions available (ADV3202/ADV3203)**
- Single 5 V supply, dual ±2.5 V supply, or dual ±3.3 V supply (G = +2)**
- Serial programming of switch array**
- 2:1 OSD insertion mux per output**
- Input sync-tip clamp**
- High impedance output disable allows connection of multiple devices with minimal output bus load**
- Excellent video performance**
 - 60 MHz, 0.1 dB gain flatness
 - 0.1% differential gain error ($R_L = 150 \Omega$)
 - 0.1° differential phase error ($R_L = 150 \Omega$)
- Excellent ac performance**
 - Bandwidth: >300 MHz
 - Slew rate: >400 V/ μ s
- Low power: 1.25 W**
- Low all hostile crosstalk of -48 dB @ 5 MHz**
- Reset pin allows disabling of all outputs**
 - Connected through a capacitor to ground, provides power-on reset capability
- 176-lead exposed pad LQFP (24 mm × 24 mm)**

APPLICATIONS

- CCTV surveillance**
- Routing of high speed signals including**
 - Composite video (NTSC, PAL, S, SECAM)
 - RGB and component video routing
 - Compressed video (MPEG, Wavelet)
- Video conferencing**

GENERAL DESCRIPTION

The ADV3200/ADV3201 are 32 × 32 analog crosspoint switch matrices. They feature a selectable sync-tip clamp input for ac-coupled applications and an on-screen display (OSD) insertion mux. With -48 dB of crosstalk and -80 dB isolation at 5 MHz, the ADV3200/ADV3201 are useful in many high density routing applications. The 0.1 dB flatness out to 60 MHz makes the ADV3200/ADV3201 ideal for composite video switching.

The 32 independent output buffers of the ADV3200/ADV3201 can be placed into a high impedance state for paralleling crosspoint outputs so that off channels present minimal loading to

FUNCTIONAL BLOCK DIAGRAM

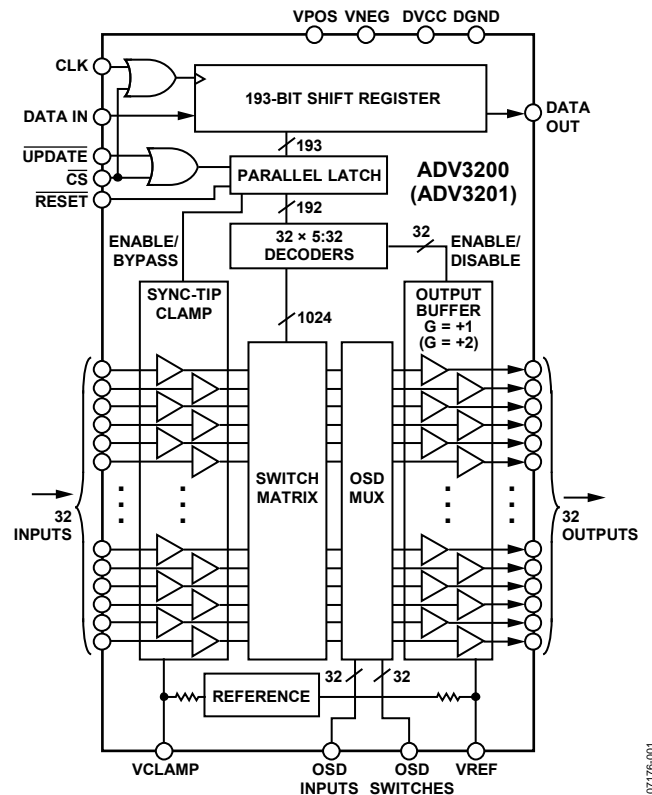

Figure 1.

an output bus if building a larger array. The part is available in a gain of +1 (ADV3200) or +2 (ADV3201) for ease of use in back-terminated load applications. A single 5 V supply, dual ±2.5 V supplies, or dual ±3.3 V supplies (G = +2) can be used while consuming only 250 mA of idle current with all outputs enabled. The channel switching is performed via a double buffered, serial digital control, which can accommodate daisy chaining of several devices.

The ADV3200/ADV3201 are packaged in a 176-lead exposed pad LQFP (24 mm × 24 mm) and are available over the extended industrial temperature range of -40°C to +85°C.

Rev. 0

Information furnished by Analog Devices is believed to be accurate and reliable. However, no responsibility is assumed by Analog Devices for its use, nor for any infringements of patents or other rights of third parties that may result from its use. Specifications subject to change without notice. No license is granted by implication or otherwise under any patent or patent rights of Analog Devices. Trademarks and registered trademarks are the property of their respective owners.

TABLE OF CONTENTS

Features	1	I/O Schematics	12
Applications	1	Typical Performance Characteristics	13
Functional Block Diagram	1	ADV3200	13
General Description	1	ADV3201	20
Revision History	2	Theory of Operation	27
Specifications	3	Applications Information	29
OSD Disabled	3	Programming	29
OSD Enabled	4	AC Coupling of Inputs	29
Timing Characteristics (Serial Mode)	5	On-Screen Display (OSD)	31
Absolute Maximum Ratings	7	Decoupling	31
Thermal Resistance	7	Power Dissipation	31
Power Dissipation	7	Crosstalk	32
ESD Caution	7	PCB Termination Layout	34
Pin Configuration and Function Descriptions	8	Outline Dimensions	36
Truth Table and Logic Diagram	11	Ordering Guide	36

REVISION HISTORY

10/08—Revision 0: Initial Version

SPECIFICATIONS

OSD DISABLED

$V_S = \pm 2.5$ V (ADV3200), $V_S = \pm 3.3$ V (ADV3201) at $T_A = 25^\circ\text{C}$, $G = +1$ (ADV3200), $G = +2$ (ADV3201), $R_L = 150\ \Omega$, all configurations, unless otherwise noted.

Table 1.

Parameter	Test Conditions/Comments	Min	Typ	Max	Unit
DYNAMIC PERFORMANCE					
–3 dB Bandwidth	200 mV p-p		300		MHz
	2 V p-p		120		MHz
Gain Flatness	0.1 dB, 200 mV p-p		60		MHz
	0.1 dB, 2 V p-p		40		MHz
Settling Time	1%, 2 V step		6		ns
Slew Rate	2 V step, peak		400		V/ μ s
NOISE/DISTORTION PERFORMANCE					
Differential Gain Error	NTSC or PAL				
ADV3200			0.06		%
ADV3201			0.1		%
Differential Phase Error	NTSC or PAL				
ADV3200			0.06		Degrees
ADV3201			0.03		Degrees
Crosstalk, All Hostile, RTI	$f = 5$ MHz, $R_L = 150\ \Omega$		–48		dB
	$f = 5$ MHz, $R_L = 1\ \text{k}\Omega$		–65		dB
	$f = 100$ MHz, $R_L = 150\ \Omega$		–23		dB
	$f = 100$ MHz, $R_L = 1\ \text{k}\Omega$		–30		dB
Off Isolation, Input-to-Output, RTI	$f = 5$ MHz, one channel		–80		dB
Input Voltage Noise	0.1 MHz to 50 MHz				
ADV3200			25		nV/ $\sqrt{\text{Hz}}$
ADV3201			22		nV/ $\sqrt{\text{Hz}}$
DC PERFORMANCE					
Gain Error					
ADV3200	No load (broadcast mode)		± 0.5	± 1.75	%
	Broadcast mode		± 0.5	± 2.2	%
ADV3201	No load (broadcast mode)		± 0.5	± 2.2	%
	Broadcast mode		± 0.5	± 2.7	%
Gain Matching	No load, channel-to-channel		± 0.5	± 2.8	%
	Channel-to-channel		± 0.8	± 3.4	%
OUTPUT CHARACTERISTICS					
Output Impedance	DC, enabled		0.15		Ω
ADV3200	DC, disabled	900	1000		k Ω
ADV3201	DC, disabled	3.2	4		k Ω
Output Capacitance	Disabled		3.7		pF
Output Voltage Range					
ADV3200		–1.1 to +1.1	–1.2 to +1.2		V
ADV3201		–1.5 to +1.5	–1.6 to +2.0		V
	No output load	–1.5 to +1.5	–2.0 to +2.0		V
INPUT CHARACTERISTICS					
Input Offset Voltage			± 5	± 30	mV
Input Voltage Range					
ADV3200		–1.1 to +1.1	–1.2 to +1.2		V
ADV3201		–0.75 to +0.75	–0.8 to +1.0		V
	No output load	–0.75 to +0.75	–1.0 to +1.0		V

ADV3200/ADV3201

www.DataSheet4U.com

Parameter	Test Conditions/Comments	Min	Typ	Max	Unit
Input Capacitance			3		pF
Input Resistance		1	4		MΩ
Input Bias Current	Sync-tip clamp enabled, $V_{IN} = V_{CLAMP} + 0.1 \text{ V}$	0.1	3	12	μA
	Sync-tip clamp enabled, $V_{IN} = V_{CLAMP} - 0.1 \text{ V}$	-2.9	-1	-0.25	mA
	Sync-tip clamp disabled	-10	-3		μA
SWITCHING CHARACTERISTICS					
Enable On Time	50% update to 1% settling		50		ns
Switching Time, 2 V Step	50% update to 1% settling		40		ns
Switching Transient (Glitch)	IN00 to IN31, RTI		300		mV p-p
POWER SUPPLIES					
Supply Current					
ADV3200	VPOS or VNEG, outputs enabled, no load		250	300	mA
	VPOS or VNEG, outputs disabled		120	155	mA
ADV3201	VPOS or VNEG, outputs enabled, no load		260	310	mA
	VPOS or VNEG, outputs disabled		130	165	mA
DVCC			2.5	3.5	mA
Supply Voltage Range	VPOS – VNEG		5 ± 10% to 6.6 ± 10%		V
PSR	VNEG, VPOS, f = 1 MHz				
ADV3200			-50		dB
ADV3201			-45		dB
OPERATING TEMPERATURE RANGE					
Temperature Range	Operating (still air)		-40 to +85		°C
θ_{JA}	Operating (still air)		16		°C/W

OSD ENABLED

$V_S = \pm 2.5 \text{ V}$ (ADV3200), $V_S = \pm 3.3 \text{ V}$ (ADV3201) at $T_A = 25^\circ\text{C}$, $G = +1$ (ADV3200), $G = +2$ (ADV3201), $R_L = 150 \Omega$, all configurations, unless otherwise noted.

Table 2.

Parameter	Test Conditions/Comments	Min	Typ	Max	Unit
OSD DYNAMIC PERFORMANCE					
-3 dB Bandwidth					
ADV3200	200 mV p-p		170		MHz
	2 V p-p		135		MHz
ADV3201	200 mV p-p		150		MHz
	2 V p-p		130		MHz
Gain Flatness	0.1 dB, 200 mV p-p		35		MHz
	0.1 dB, 2 V p-p		35		MHz
Settling Time	1%, 2 V step		6		ns
Slew Rate	2 V step, peak		400		V/μs
OSD NOISE/DISTORTION PERFORMANCE					
Differential Gain Error	NTSC or PAL				
ADV3200			0.12		%
ADV3201			0.35		%
Differential Phase Error	NTSC or PAL				
ADV3200			0.06		Degrees
ADV3201			0.04		Degrees
Input Voltage Noise	0.5 MHz to 50 MHz				
ADV3200			27		nV/√Hz
ADV3201			25		nV/√Hz

Parameter	Test Conditions/Comments	Min	Typ	Max	Unit
OSD DC PERFORMANCE					
Gain Error					
ADV3200	No load		±0.1	±2.3	%
ADV3201	No load		±0.1	±2.7	%
OSD INPUT CHARACTERISTICS					
Input Offset Voltage			±5	±30	mV
Input Bias Current		-10	-4		μA
OSD SWITCHING CHARACTERISTICS					
OSD Switch Delay, 2 V Step	50% OSD switch to 1% settling		20		ns
OSD Switching Transient (Glitch)					
ADV3200			15		mV p-p
ADV3201			40		mV p-p

TIMING CHARACTERISTICS (SERIAL MODE)

Table 3.

Parameter	Symbol	Min	Limit		Unit
			Typ	Max	
Serial Data Setup Time	t_1	40			ns
CLK Pulse Width	t_2	50			ns
Serial Data Hold Time	t_3	50			ns
CLK Pulse Separation	t_4	150			ns
CLK to UPDATE Delay	t_5		50	160	ns
UPDATE Pulse Width	t_6	40			ns
CLK to DATA OUT Valid	t_7			130	ns
Propagation Delay, UPDATE to Switch On or Off			50		ns
Data Load Time, CLK = 5 MHz, Serial Mode			38.6		μs
RESET Time			160		ns

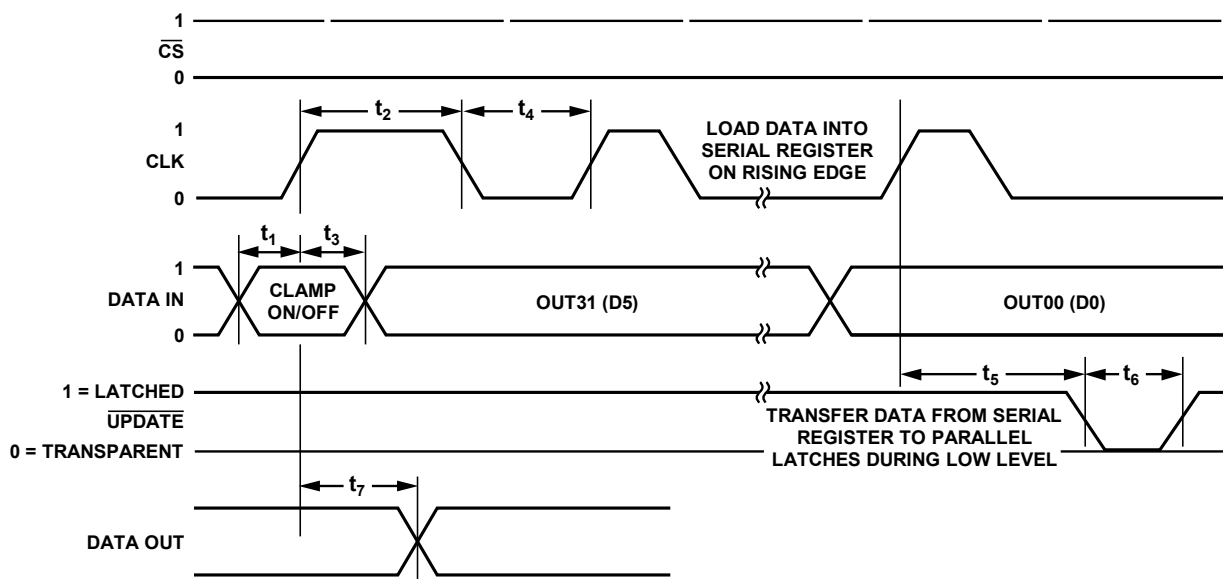

Figure 2. Timing Diagram, Serial Mode

07176-002

ADV3200/ADV3201

www.DataSheet4U.com

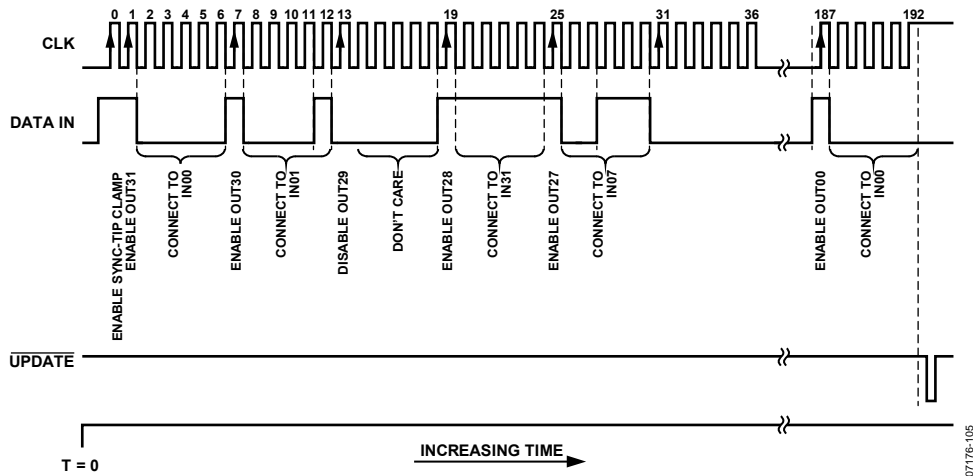

Figure 3. Programming Example

07176-105

Table 4. Logic Levels, DVCC = 3.3 V

V_{IH}	V_{IL}	V_{OH}	V_{OL}	I_{IH}	I_{IL}	I_{OH}	I_{OL}
RESET, \overline{CS} , CLK, DATA IN, UPDATE, OSDS	RESET, \overline{CS} , CLK, DATA IN, UPDATE, OSDS	DATA OUT	DATA OUT	RESET, \overline{CS} , CLK, DATA IN, UPDATE, OSDS	RESET, \overline{CS} , CLK, DATA IN, UPDATE, OSDS	DATA OUT	DATA OUT
2.5 V min	0.8 V max	2.7 V min	0.5 V max	0.5 μ A typ	-0.5 μ A typ	3 mA typ	-3 mA typ

ABSOLUTE MAXIMUM RATINGS

Table 5.

Parameter	Rating
Analog Supply Voltage (VPOS – VNEG)	7.5 V
Digital Supply Voltage (DVCC – DGND)	6 V
Ground Potential Difference (VNEG – DGND)	+0.5 V to –4 V
Maximum Potential Difference DVCC – VNEG	9.4 V
Disabled Outputs ADV3200 ($ V_{OSD} - V_{OUT} $)	<3 V
ADV3201 ($ V_{OSD} - (V_{OUT} + V_{REF})/2 $)	<3 V
$ V_{CLAMP} - V_{INXX} $	6 V
VREF Input Voltage ADV3200	VPOS – 3.5 V to VNEG + 3.5 V
ADV3201	VPOS – 4 V to VNEG + 4 V
Analog Input Voltage	VNEG to VPOS
Digital Input Voltage	DVCC
Output Voltage (Disabled Analog Output)	(VPOS – 1 V) to (VNEG + 1 V)
Output Short-Circuit Duration	Momentary
Output Short-Circuit Current	45 mA
Storage Temperature Range	–65°C to +125°C
Operating Temperature Range	–40°C to +85°C
Lead Temperature (Soldering 10 sec)	300°C
Junction Temperature	150°C

Stresses above those listed under Absolute Maximum Ratings may cause permanent damage to the device. This is a stress rating only; functional operation of the device at these or any other conditions above those indicated in the operational section of this specification is not implied. Exposure to absolute maximum rating conditions for extended periods may affect device reliability.

THERMAL RESISTANCE

θ_{JA} is specified for the worst-case conditions, that is, a device soldered in a circuit board for surface-mount packages.

Table 6. Thermal Resistance

Package Type	θ_{JA}	Unit
176-Lead LQFP_EP	16	°C/W

POWER DISSIPATION

The ADV3200/ADV3201 are operated with ± 2.5 V, 5 V, or ± 3.3 V supplies and can drive loads down to 150 Ω , resulting in a large range of possible power dissipations. For this reason, extra care must be taken to derate the operating conditions based on ambient temperature.

The ADV3200/ADV3201 are packaged in a 176-lead exposed pad LQFP. The junction-to-ambient thermal impedance (θ_{JA}) of the ADV3200/ADV3201 is 16°C/W. For long-term reliability, the maximum allowed junction temperature of the die should not exceed 150°C. Temporarily exceeding this limit may cause a shift in parametric performance due to a change in stresses exerted on the die by the package. Exceeding a junction temperature of 175°C for an extended period can result in device failure. Figure 4 shows the range of allowed internal die power dissipations that meet these conditions over the –40°C to +85°C ambient temperature range. When using Figure 4, do not include external load power in the maximum power calculation, but do include load current dropped on the die output transistors.

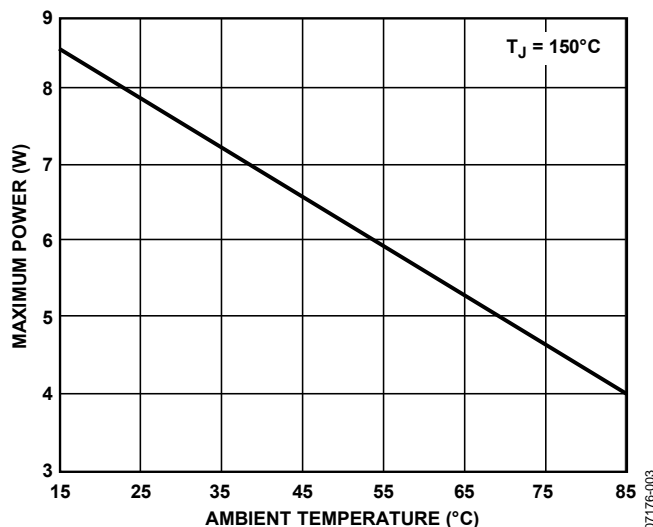

Figure 4. Maximum Die Power Dissipation vs. Ambient Temperature

ESD CAUTION



ESD (electrostatic discharge) sensitive device. Charged devices and circuit boards can discharge without detection. Although this product features patented or proprietary protection circuitry, damage may occur on devices subjected to high energy ESD. Therefore, proper ESD precautions should be taken to avoid performance degradation or loss of functionality.

PIN CONFIGURATION AND FUNCTION DESCRIPTIONS

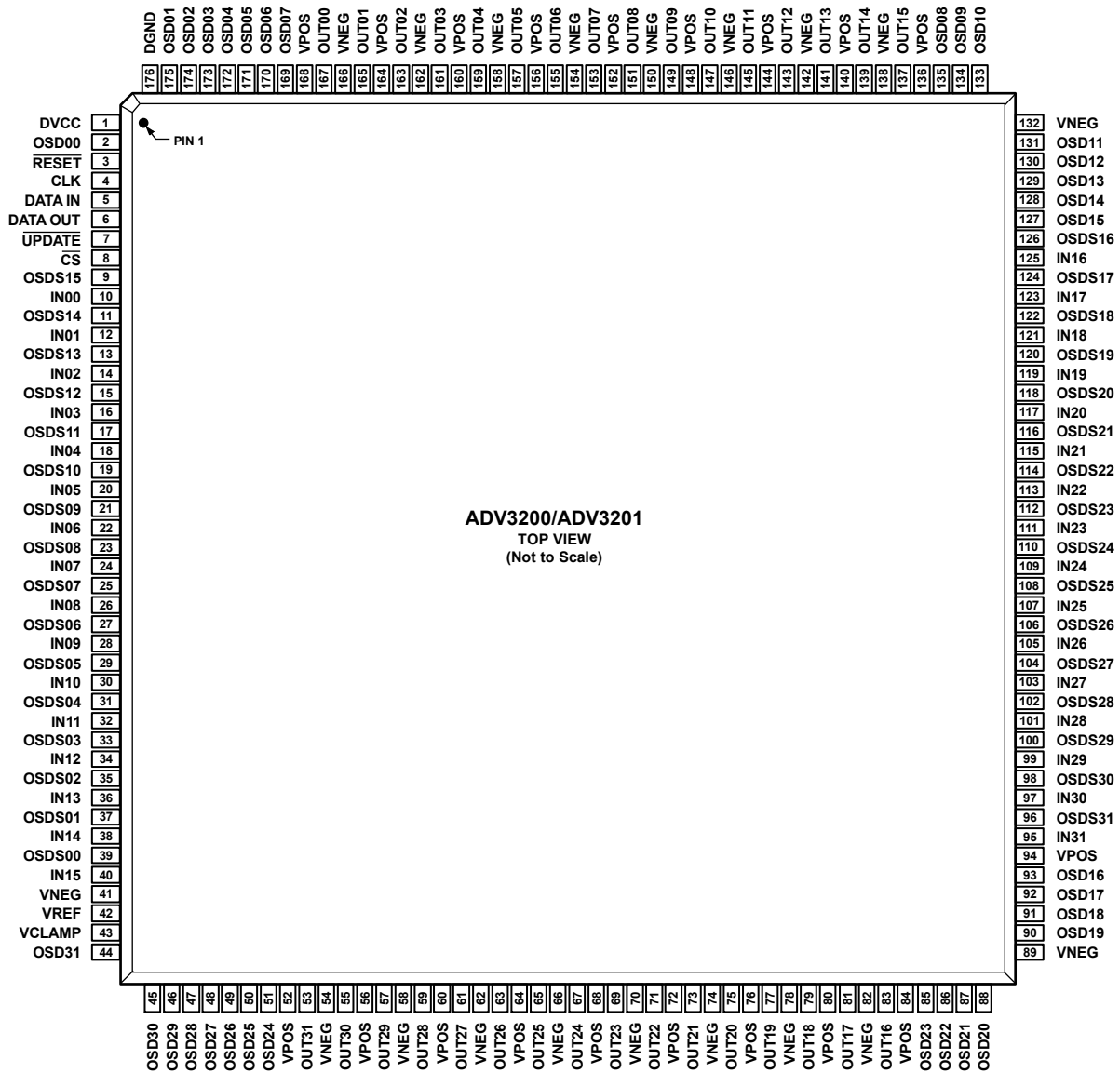

NOTES

- OSDSxx: OSD SELECT FOR OUTxx
OSDxx: OSD VIDEO INPUT FOR OUTxx
- THE EXPOSED PAD SHOULD BE CONNECTED TO ANALOG GROUND.

Figure 5. Pin Configuration

07176-004

Table 7. Pin Function Descriptions

Pin	Mnemonic	Description	Pin	Mnemonic	Description
1	DVCC	Digital Positive Power Supply.	50	OSD25	OSD Input Number 25.
2	OSD00	OSD Input Number 0.	51	OSD24	OSD Input Number 24.
3	RESET	Control Pin: First and Second Rank Reset.	52	VPOS	Analog Positive Power Supply.
4	CLK	Control Pin: Serial Data Clock.	53	OUT31	Output Number 31.
5	DATA IN	Control Pin: Serial Data In.	54	VNEG	Analog Negative Power Supply.
6	DATA OUT	Control Pin: Serial Data Out.	55	OUT30	Output Number 30.
7	UPDATE	Control Pin: Second Rank Write Strobe.	56	VPOS	Analog Positive Power Supply.
8	\overline{CS}	Control Pin: Chip Select.	57	OUT29	Output Number 29.
9	OSDS15	Control Pin: OSD Select Number 15.	58	VNEG	Analog Negative Power Supply.
10	IN00	Input Number 0.	59	OUT28	Output Number 28.
11	OSDS14	Control Pin: OSD Select Number 14.	60	VPOS	Analog Positive Power Supply.
12	IN01	Input Number 1.	61	OUT27	Output Number 27.
13	OSDS13	Control Pin: OSD Select Number 13.	62	VNEG	Analog Negative Power Supply.
14	IN02	Input Number 2.	63	OUT26	Output Number 26.
15	OSDS12	Control Pin: OSD Select Number 12.	64	VPOS	Analog Positive Power Supply.
16	IN03	Input Number 3.	65	OUT25	Output Number 25.
17	OSDS11	Control Pin: OSD Select Number 11.	66	VNEG	Analog Negative Power Supply.
18	IN04	Input Number 4.	67	OUT24	Output Number 24.
19	OSDS10	Control Pin: OSD Select Number 10.	68	VPOS	Analog Positive Power Supply.
20	IN05	Input Number 5.	69	OUT23	Output Number 23.
21	OSDS09	Control Pin: OSD Select Number 9.	70	VNEG	Analog Negative Power Supply.
22	IN06	Input Number 6.	71	OUT22	Output Number 22.
23	OSDS08	Control Pin: OSD Select Number 8.	72	VPOS	Analog Positive Power Supply.
24	IN07	Input Number 7.	73	OUT21	Output Number 21.
25	OSDS07	Control Pin: OSD Select Number 7.	74	VNEG	Analog Negative Power Supply.
26	IN08	Input Number 8.	75	OUT20	Output Number 20.
27	OSDS06	Control Pin: OSD Select Number 6.	76	VPOS	Analog Positive Power Supply.
28	IN09	Input Number 9.	77	OUT19	Output Number 19.
29	OSDS05	Control Pin: OSD Select Number 5.	78	VNEG	Analog Negative Power Supply.
30	IN10	Input Number 10.	79	OUT18	Output Number 18.
31	OSDS04	Control Pin: OSD Select Number 4.	80	VPOS	Analog Positive Power Supply.
32	IN11	Input Number 11.	81	OUT17	Output Number 17.
33	OSDS03	Control Pin: OSD Select Number 3.	82	VNEG	Analog Negative Power Supply.
34	IN12	Input Number 12.	83	OUT16	Output Number 16.
35	OSDS02	Control Pin: OSD Select Number 2.	84	VPOS	Analog Positive Power Supply.
36	IN13	Input Number 13.	85	OSD23	OSD Input Number 23.
37	OSDS01	Control Pin: OSD Select Number 1.	86	OSD22	OSD Input Number 22.
38	IN14	Input Number 14.	87	OSD21	OSD Input Number 21.
39	OSDS00	Control Pin: OSD Select Number 0.	88	OSD20	OSD Input Number 20.
40	IN15	Input Number 15.	89	VNEG	Analog Negative Power Supply.
41	VNEG	Analog Negative Power Supply.	90	OSD19	OSD Input Number 19.
42	VREF	Reference Voltage. See the Theory of Operation section for details.	91	OSD18	OSD Input Number 18.
43	VCLAMP	Sync-Tip Clamp Voltage. See the Theory of Operation section for details.	92	OSD17	OSD Input Number 17.
44	OSD31	OSD Input Number 31.	93	OSD16	OSD Input Number 16.
45	OSD30	OSD Input Number 30.	94	VPOS	Analog Positive Power Supply.
46	OSD29	OSD Input Number 29.	95	IN31	Input Number 31.
47	OSD28	OSD Input Number 28.	96	OSDS31	Control Pin: OSD Select Number 31.
48	OSD27	OSD Input Number 27.	97	IN30	Input Number 30.
49	OSD26	OSD Input Number 26.	98	OSDS30	Control Pin: OSD Select Number 30.
			99	IN29	Input Number 29.
			100	OSDS29	Control Pin: OSD Select Number 29.

ADV3200/ADV3201

www.DataSheet4U.com

Pin	Mnemonic	Description
101	IN28	Input Number 28.
102	OSDS28	Control Pin: OSD Select Number 28.
103	IN27	Input Number 27.
104	OSDS27	Control Pin: OSD Select Number 27.
105	IN26	Input Number 26.
106	OSDS26	Control Pin: OSD Select Number 26.
107	IN25	Input Number 25.
108	OSDS25	Control Pin: OSD Select Number 25.
109	IN24	Input Number 24.
110	OSDS24	Control Pin: OSD Select Number 24.
111	IN23	Input Number 23.
112	OSDS23	Control Pin: OSD Select Number 23.
113	IN22	Input Number 22.
114	OSDS22	Control Pin: OSD Select Number 22.
115	IN21	Input Number 21.
116	OSDS21	Control Pin: OSD Select Number 21.
117	IN20	Input Number 20.
118	OSDS20	Control Pin: OSD Select Number 20.
119	IN19	Input Number 19.
120	OSDS19	Control Pin: OSD Select Number 19.
121	IN18	Input Number 18.
122	OSDS18	Control Pin: OSD Select Number 18.
123	IN17	Input Number 17.
124	OSDS17	Control Pin: OSD Select Number 17.
125	IN16	Input Number 16.
126	OSDS16	Control Pin: OSD Select Number 16.
127	OSD15	OSD Input Number 15.
128	OSD14	OSD Input Number 14.
129	OSD13	OSD Input Number 13.
130	OSD12	OSD Input Number 12.
131	OSD11	OSD Input Number 11.
132	VNEG	Analog Negative Power Supply.
133	OSD10	OSD Input Number 10.
134	OSD09	OSD Input Number 9.
135	OSD08	OSD Input Number 8.
136	VPOS	Analog Positive Power Supply.
137	OUT15	Output Number 15.
138	VNEG	Analog Negative Power Supply.
139	OUT14	Output Number 14.

Pin	Mnemonic	Description
140	VPOS	Analog Positive Power Supply.
141	OUT13	Output Number 13.
142	VNEG	Analog Negative Power Supply.
143	OUT12	Output Number 12.
144	VPOS	Analog Positive Power Supply.
145	OUT11	Output Number 11.
146	VNEG	Analog Negative Power Supply.
147	OUT10	Output Number 10.
148	VPOS	Analog Positive Power Supply.
149	OUT09	Output Number 9.
150	VNEG	Analog Negative Power Supply.
151	OUT08	Output Number 8.
152	VPOS	Analog Positive Power Supply.
153	OUT07	Output Number 7.
154	VNEG	Analog Negative Power Supply.
155	OUT06	Output Number 6.
156	VPOS	Analog Positive Power Supply.
157	OUT05	Output Number 5.
158	VNEG	Analog Negative Power Supply.
159	OUT04	Output Number 4.
160	VPOS	Analog Positive Power Supply.
161	OUT03	Output Number 3.
162	VNEG	Analog Negative Power Supply.
163	OUT02	Output Number 2.
164	VPOS	Analog Positive Power Supply.
165	OUT01	Output Number 1.
166	VNEG	Analog Negative Power Supply.
167	OUT00	Output Number 0.
168	VPOS	Analog Positive Power Supply.
169	OSD07	OSD Input Number 7.
170	OSD06	OSD Input Number 6.
171	OSD05	OSD Input Number 5.
172	OSD04	OSD Input Number 4.
173	OSD03	OSD Input Number 3.
174	OSD02	OSD Input Number 2.
175	OSD01	OSD Input Number 1.
176	DGND	Digital Negative Power Supply.
	Exposed Pad	Connect to analog ground.

TRUTH TABLE AND LOGIC DIAGRAM

Table 8. Operation Truth Table

CS	UPDATE	CLK	DATA IN	DATA OUT	RESET	Operation/Comment
X ¹	X	X	X	X	0	Asynchronous reset. All outputs are disabled. The 193-bit shift register is reset to all 0s.
0	1	\downarrow	Data _i ²	Data _{i-193}	1	The data on the serial DATA IN line is loaded into the serial register. The first bit clocked into the serial register appears at DATA OUT 193 clock cycles later.
0	0	X	X	X	1	Switch matrix update. Data in the 193-bit shift register is transferred into the parallel latches that control the switch array and sync-tip clamps.
1	X	X	X	X	1	Chip is not selected. No change in logic.

¹ X = don't care.
² Data_i: serial data.

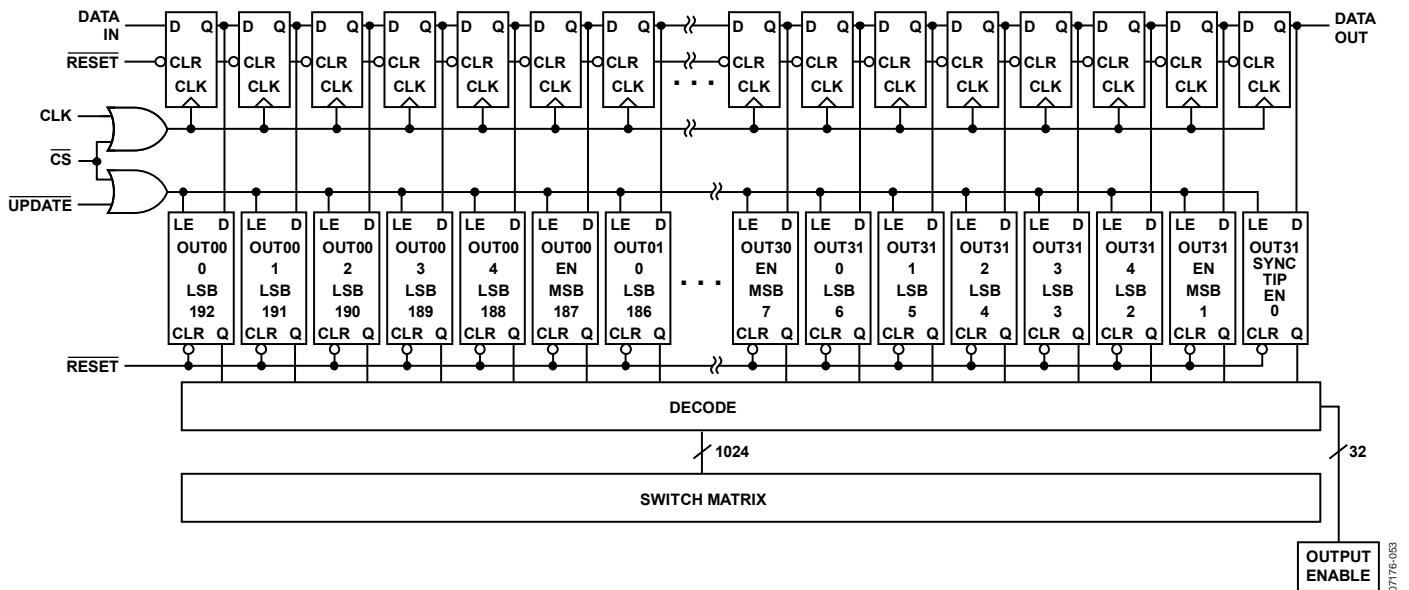

Figure 6. Logic Diagram

I/O SCHEMATICS

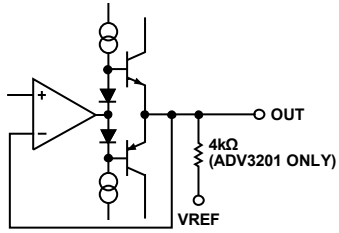

Figure 7. Enabled Output
(See Also Figure 16)

07176-054

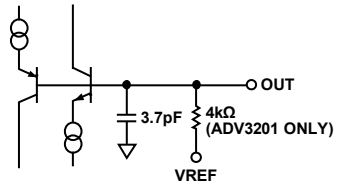

Figure 8. Disabled Output
(See Also Figure 16)

07176-055

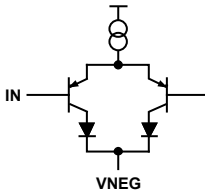

Figure 9. Receiver
(See Also Figure 16)

07176-056

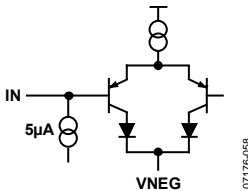

Figure 10. Receiver with Sync-Tip Clamp Enabled
(See Also Figure 16)

07176-058

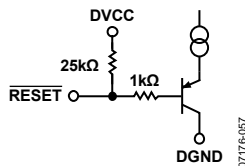

Figure 11. Reset Input
(See Also Figure 16)

07176-057

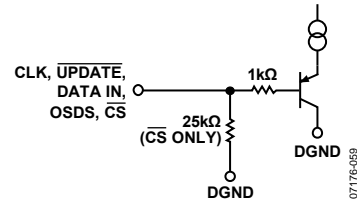

Figure 12. Logic Input
(See Also Figure 16)

07176-059

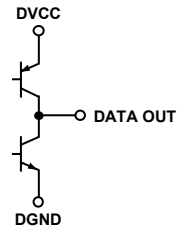

Figure 13. Logic Output
(See Also Figure 16)

07176-060

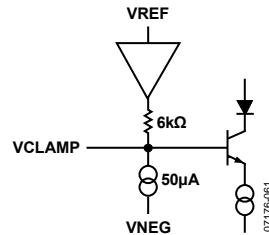

Figure 14. VCLAMP Input
(See Also Figure 16)

07176-061

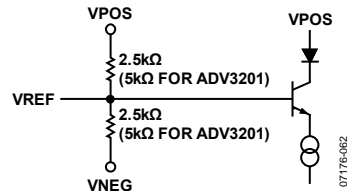

Figure 15. VREF Input
(See Also Figure 16)

07176-062

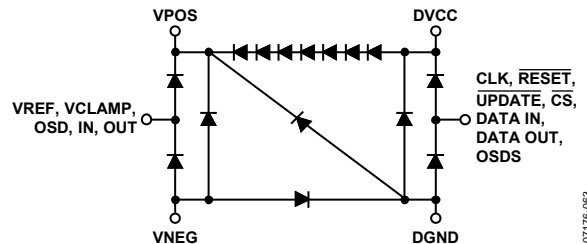

Figure 16. ESD Protection Map

07176-063

TYPICAL PERFORMANCE CHARACTERISTICS

ADV3200

$V_S = \pm 2.5\text{ V}$ at $T_A = 25^\circ\text{C}$, $R_L = 150\ \Omega$.

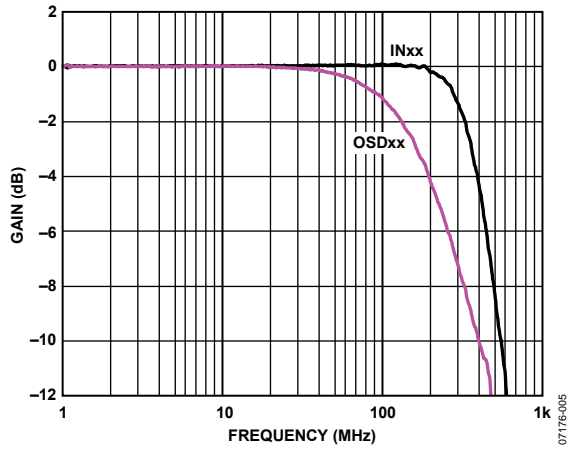

Figure 17. ADV3200 Small Signal Frequency Response, 200 mV p-p

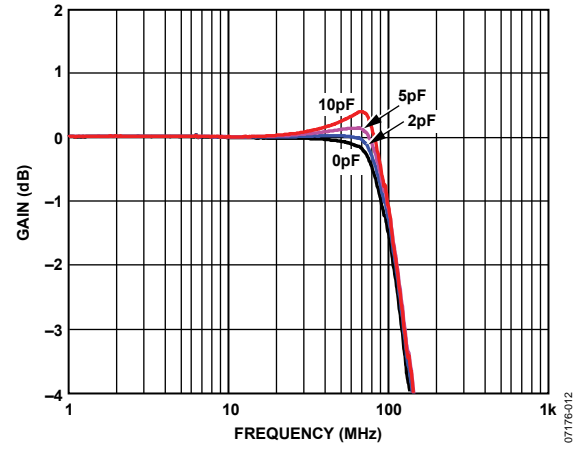

Figure 20. ADV3200 Large Signal Frequency Response with Capacitive Loads, 2 V p-p

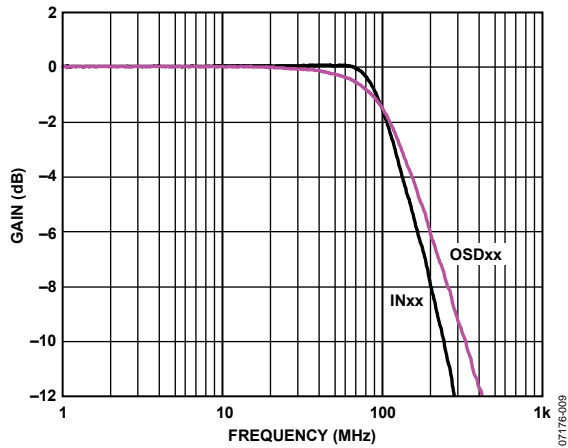

Figure 18. ADV3200 Large Signal Frequency Response, 2 V p-p

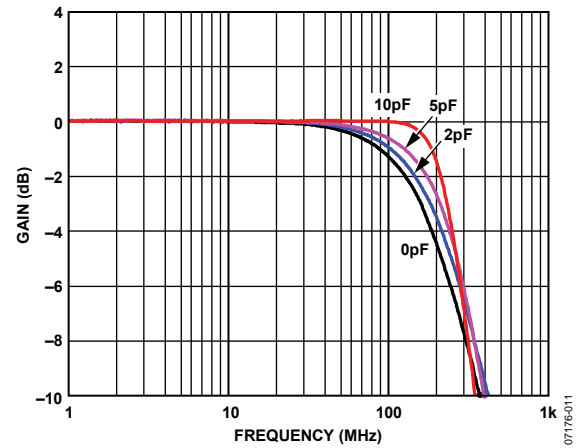

Figure 21. ADV3200 OSD Small Signal Frequency Response with Capacitive Loads, 200 mV p-p

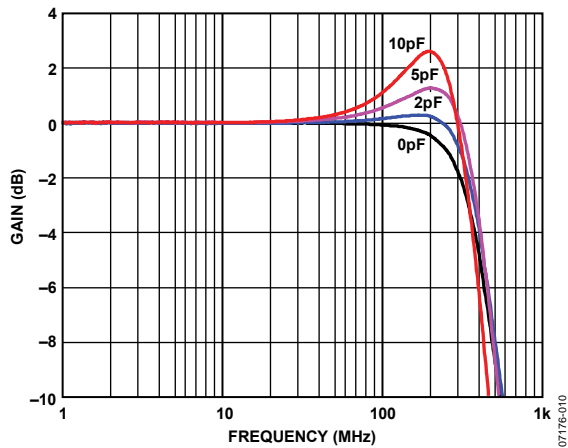

Figure 19. ADV3200 Small Signal Frequency Response with Capacitive Loads, 200 mV p-p

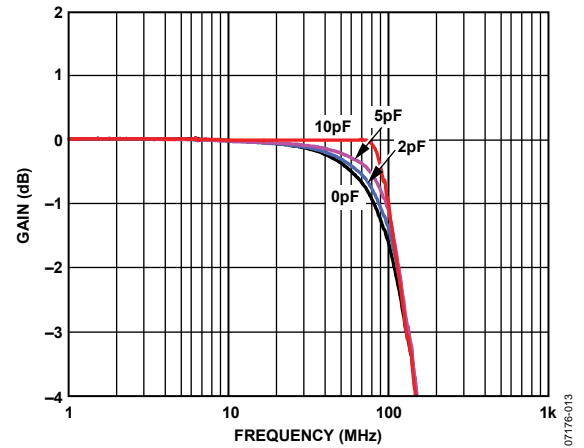

Figure 22. ADV3200 OSD Large Signal Frequency Response with Capacitive Loads, 2 V p-p

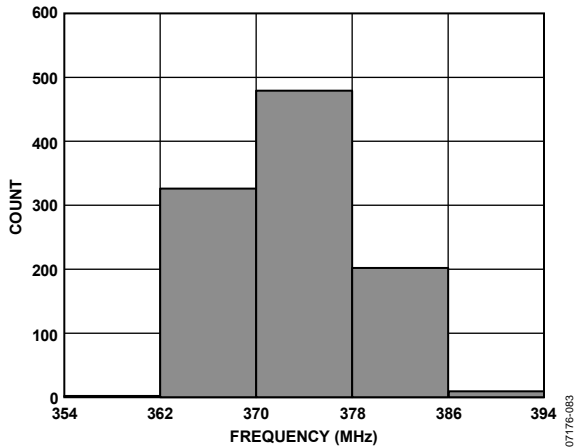

Figure 23. ADV3200 -3 dB Bandwidth Histogram, One Device, All 1024 Channels

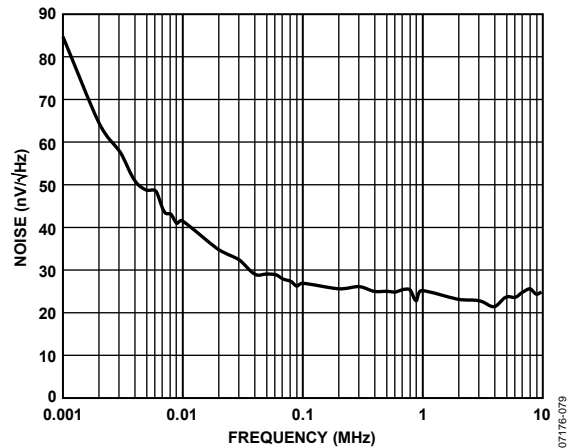

Figure 26. ADV3200 Output Noise

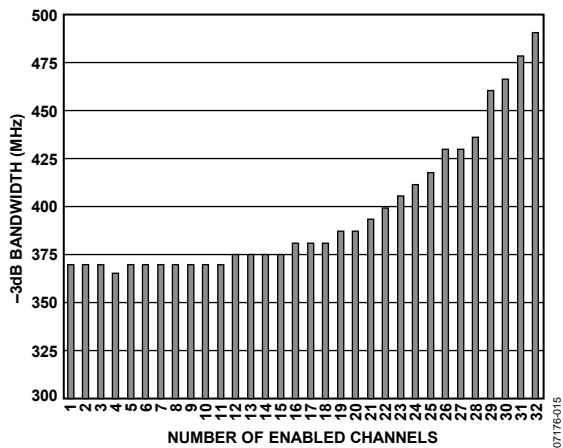

Figure 24. ADV3200 Small Signal Bandwidth vs. Enabled Channels

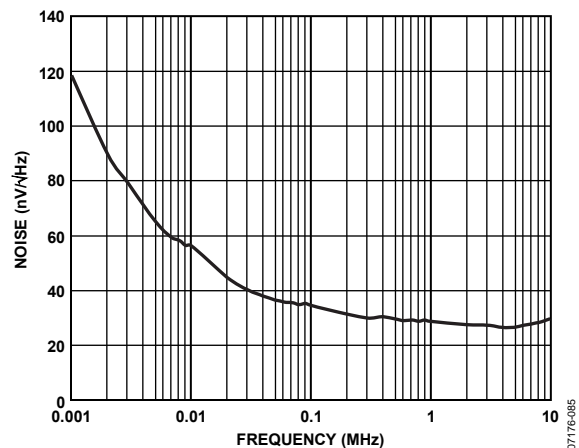

Figure 27. ADV3200 OSD Output Noise

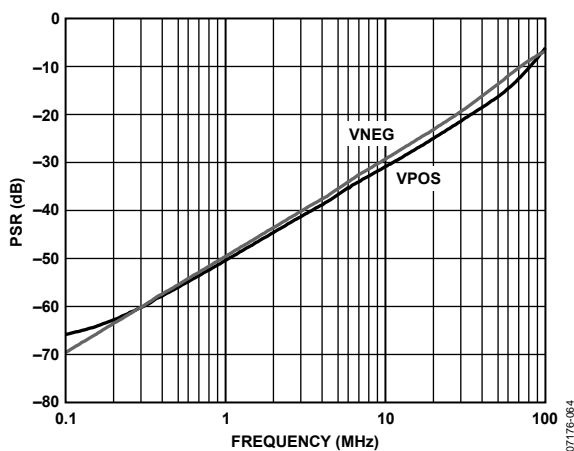

Figure 25. ADV3200 Power Supply Rejection

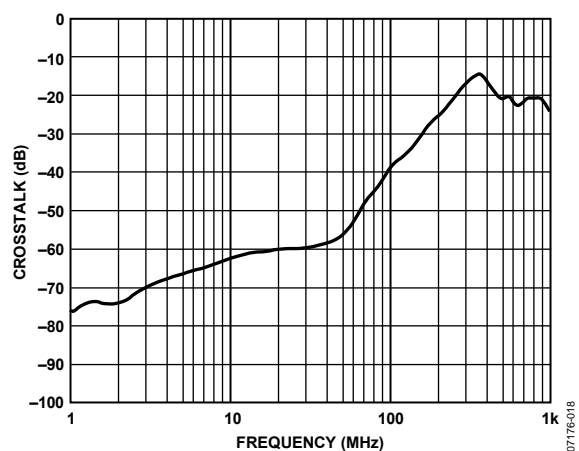

Figure 28. ADV3200 Crosstalk, One Adjacent Channel, RTO

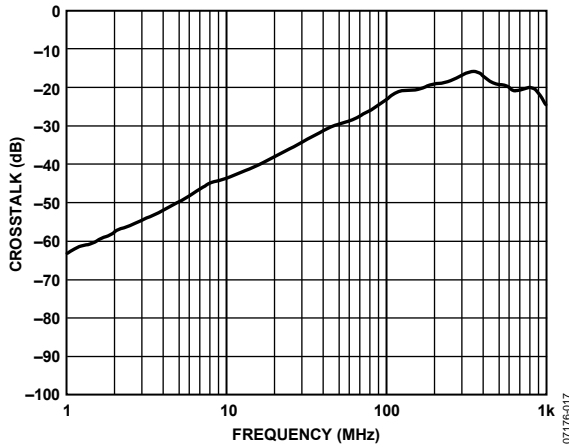

Figure 29. ADV3200 Crosstalk, All Hostile, RTO

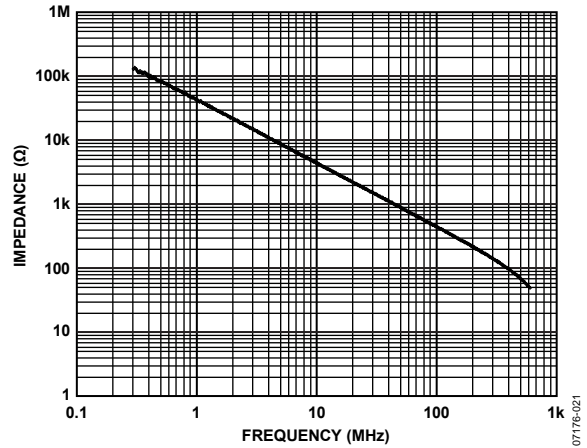

Figure 32. ADV3200 Output Impedance, Disabled

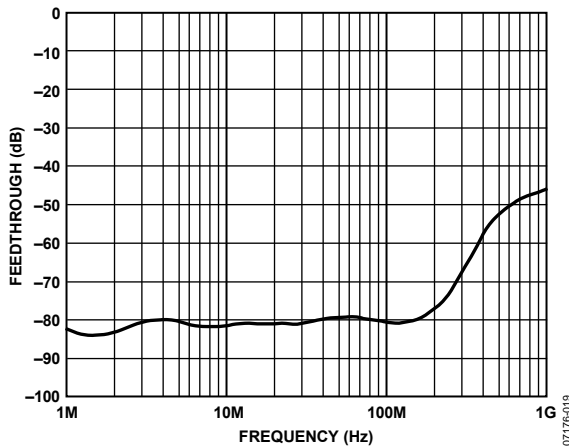

Figure 30. ADV3200 Off Isolation, RTO

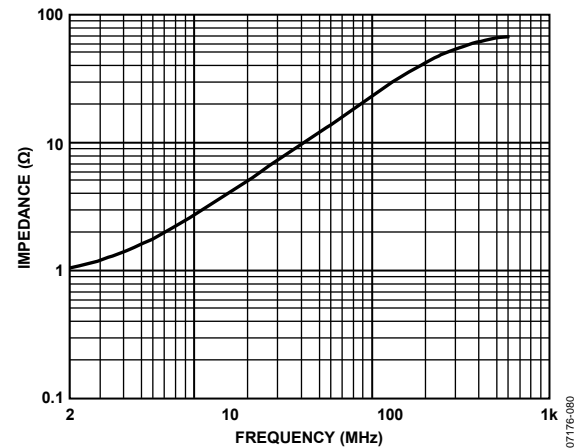

Figure 33. ADV3200 Output Impedance, Enabled

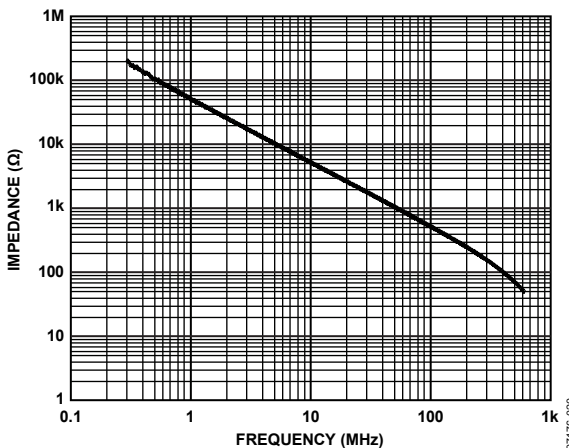

Figure 31. ADV3200 Input Impedance

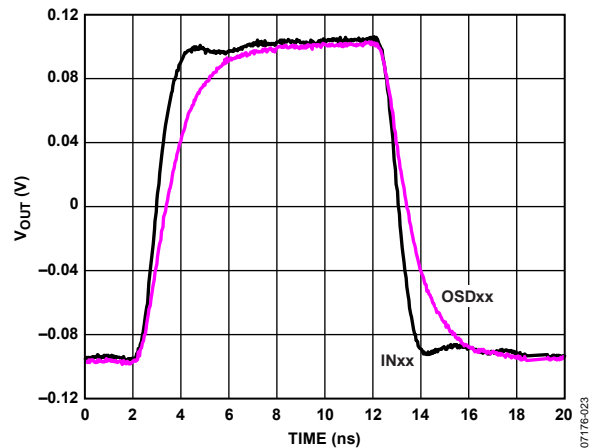

Figure 34. ADV3200 Small Signal Pulse Response, 200 mV p-p

ADV3200/ADV3201

www.DataSheet4U.com

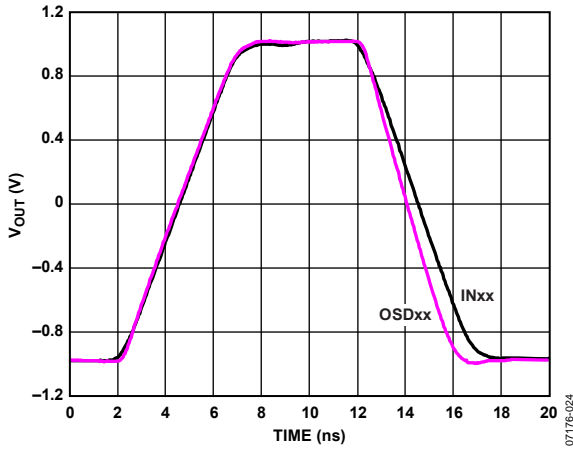

Figure 35. ADV3200 Large Signal Pulse Response, 2 V p-p

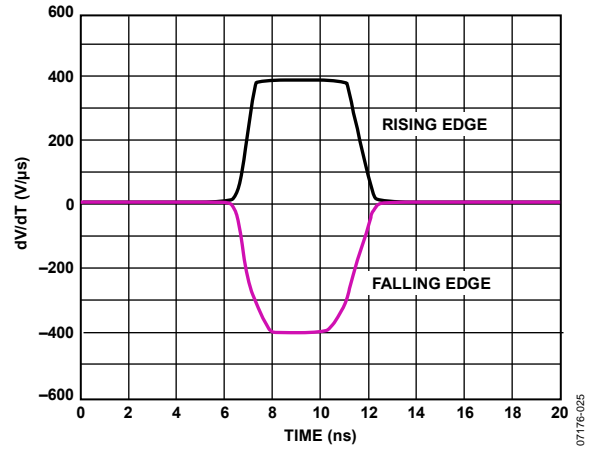

Figure 38. ADV3200 Slew Rate

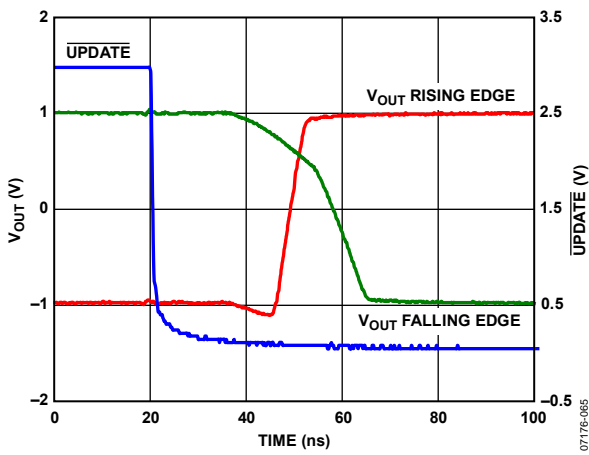

Figure 36. ADV3200 Switching Time

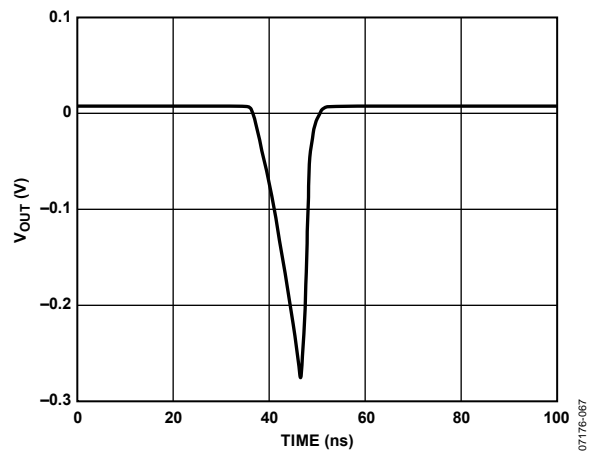

Figure 39. ADV3200 Switching Glitch

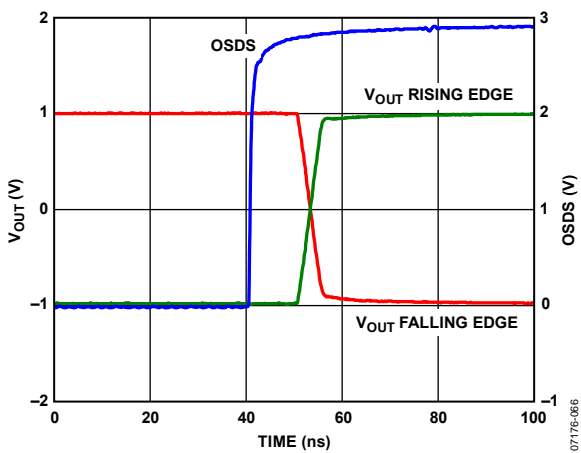

Figure 37. ADV3200 OSD Switching Time

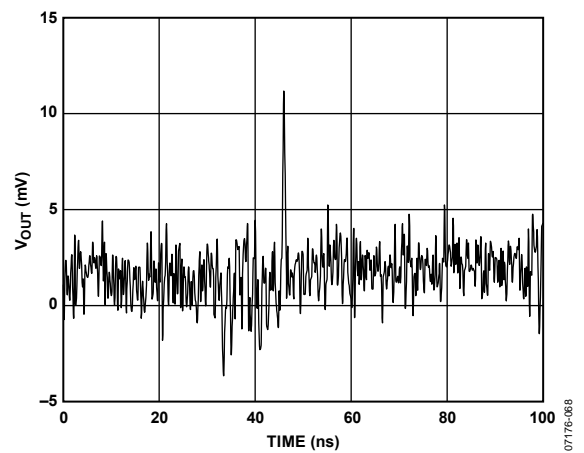

Figure 40. ADV3200 OSD Switching Glitch

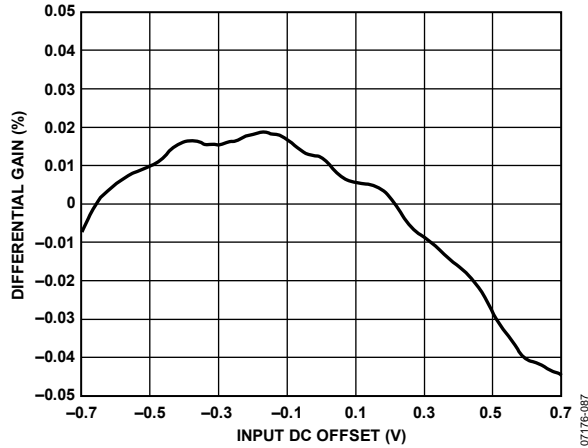

Figure 41. ADV3200 Differential Gain, Carrier Frequency = 3.58 MHz, Subcarrier Amplitude = 300 mV p-p

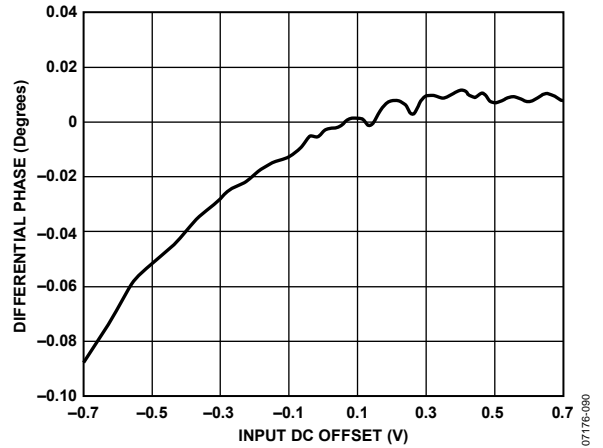

Figure 44. ADV3200 OSD Differential Phase, Carrier Frequency = 3.58 MHz, Subcarrier Amplitude = 300 mV p-p

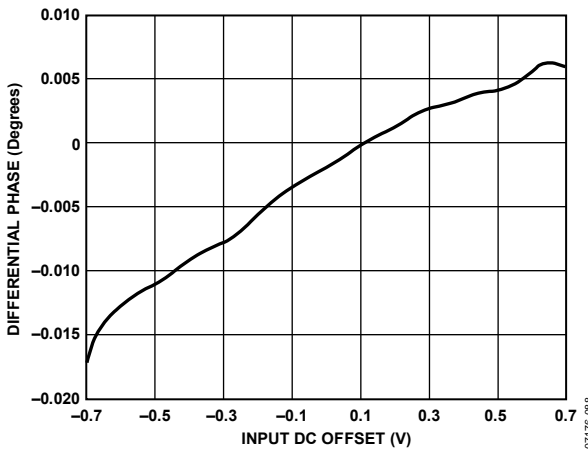

Figure 42. ADV3200 Differential Phase, Carrier Frequency = 3.58 MHz, Subcarrier Amplitude = 300 mV p-p

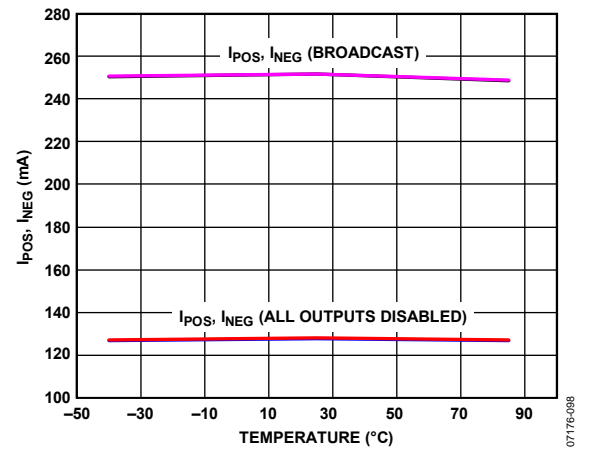

Figure 45. ADV3200 Supply Current vs. Temperature

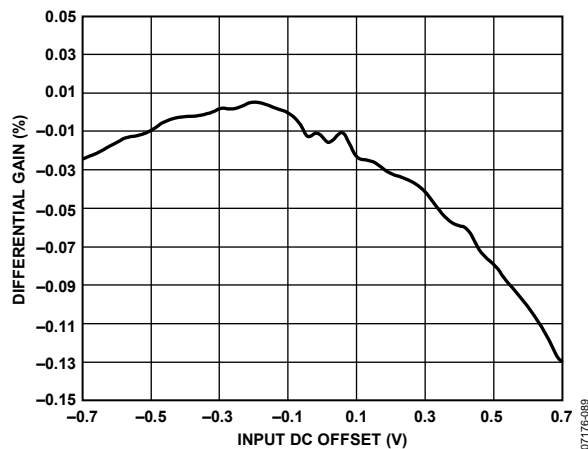

Figure 43. ADV3200 OSD Differential Gain, Carrier Frequency = 3.58 MHz, Subcarrier Amplitude = 300 mV p-p

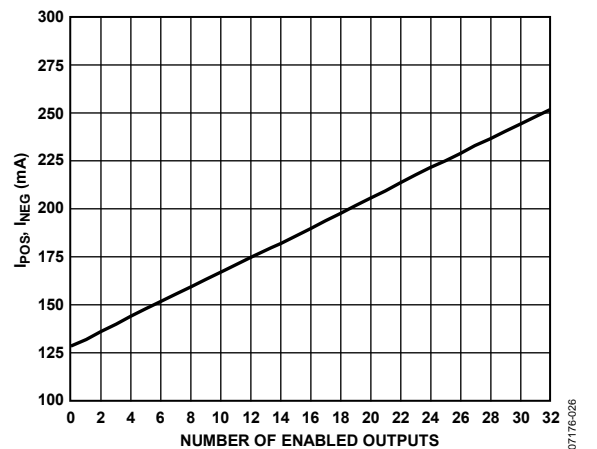

Figure 46. ADV3200 Supply Current vs. Enabled Outputs

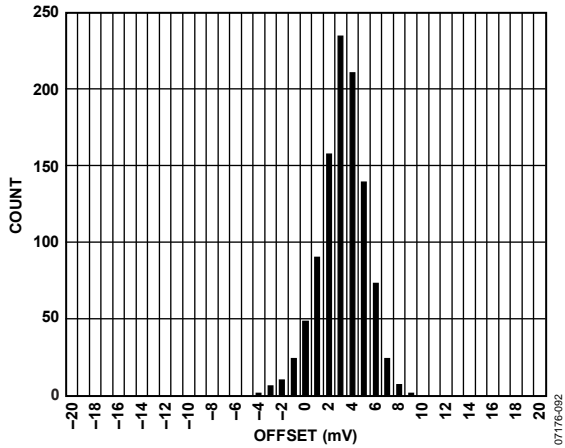

Figure 47. ADV3200 Input Offset Distribution, One Device, All 1024 Channels

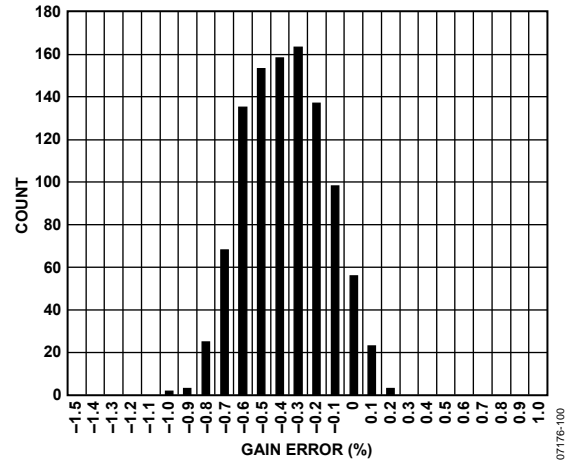

Figure 50. ADV3200 Gain Error Distribution, One Device, All 1024 Channels

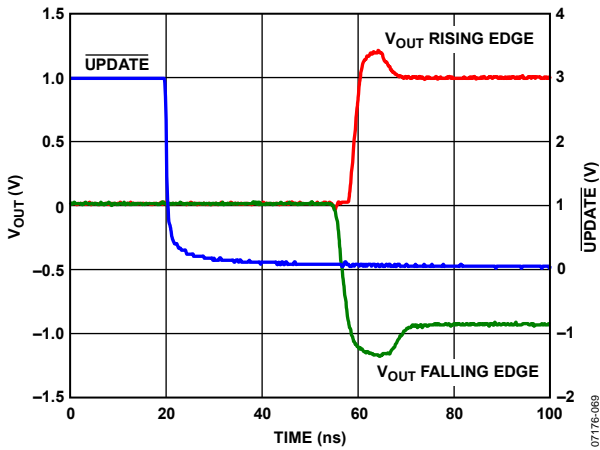

Figure 48. ADV3200 Enable Time

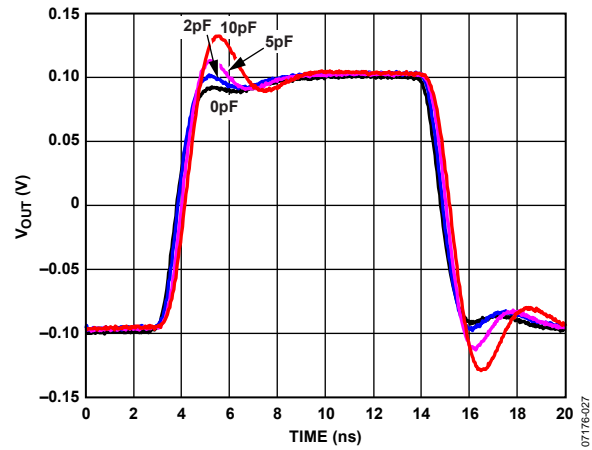

Figure 51. ADV3200 Small Signal Pulse with Capacitive Loads, 200 mV p-p

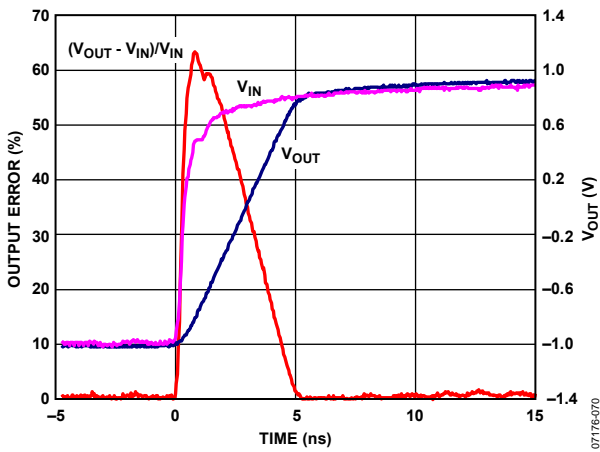

Figure 49. ADV3200 Settling Time

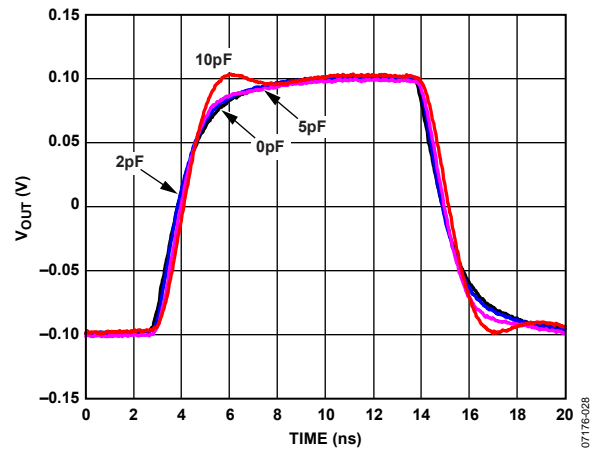

Figure 52. ADV3200 OSD Small Signal Pulse with Capacitive Loads, 200 mV p-p

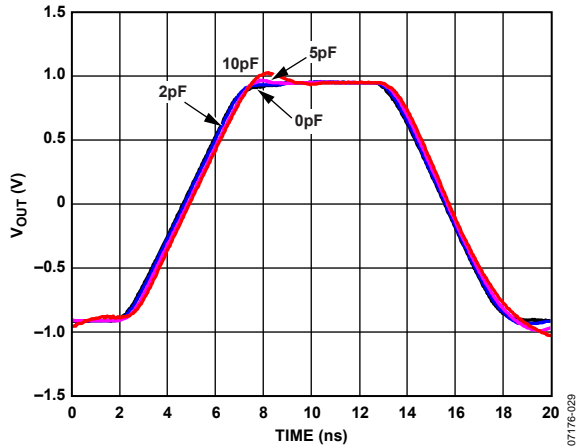

Figure 53. ADV3200 Large Signal Pulse with Capacitive Loads, 2 V p-p

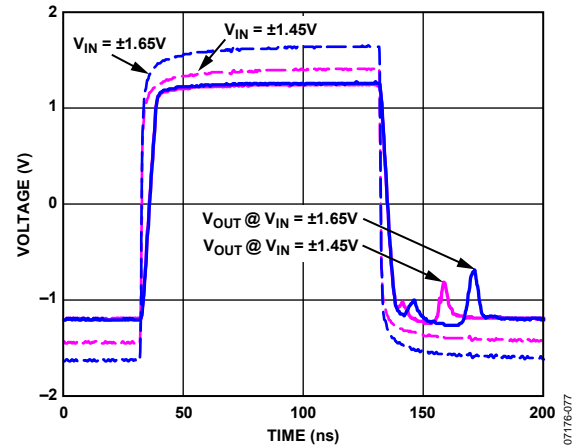

Figure 55. ADV3200 Overdrive Recovery

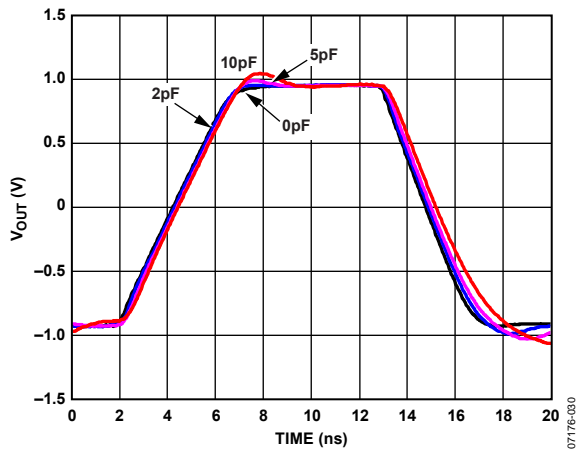

Figure 54. ADV3200 OSD Large Signal Pulse with Capacitive Loads, 2 V p-p

ADV3200/ADV3201

www.DataSheet4U.com

ADV3201

$V_S = \pm 3.3 \text{ V}$ at $T_A = 25^\circ\text{C}$, $R_L = 150 \Omega$.

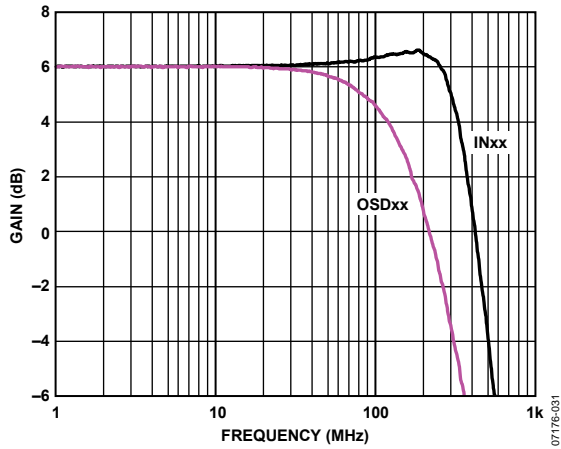

Figure 56. ADV3201 Small Signal Frequency Response, 200 mV p-p

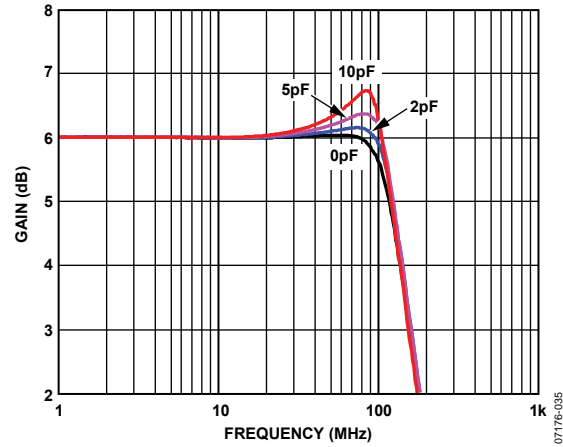

Figure 59. ADV3201 Large Signal Frequency Response with Capacitive Loads, 2 V p-p

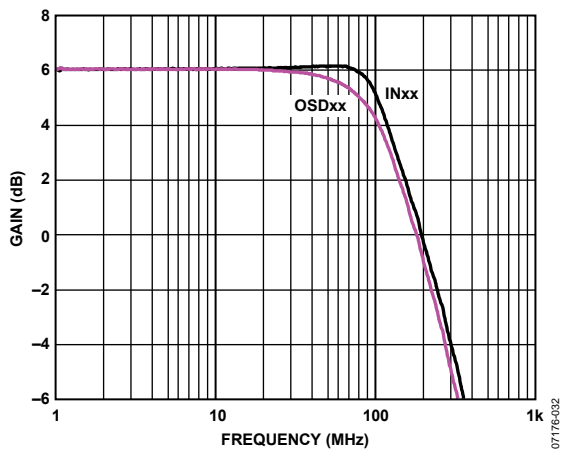

Figure 57. ADV3201 Large Signal Frequency Response, 2 V p-p

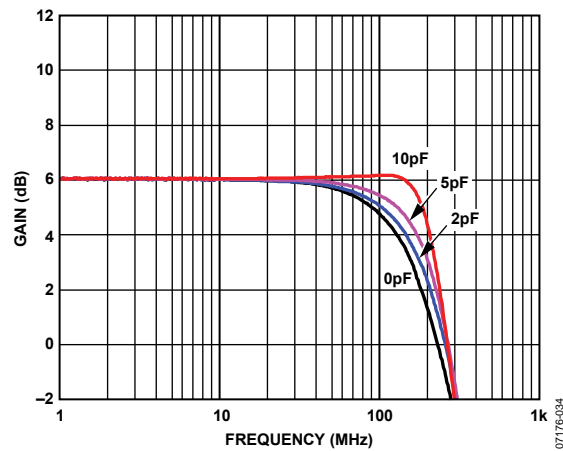

Figure 60. ADV3201 OSD Small Signal Frequency Response with Capacitive Loads, 200 mV p-p

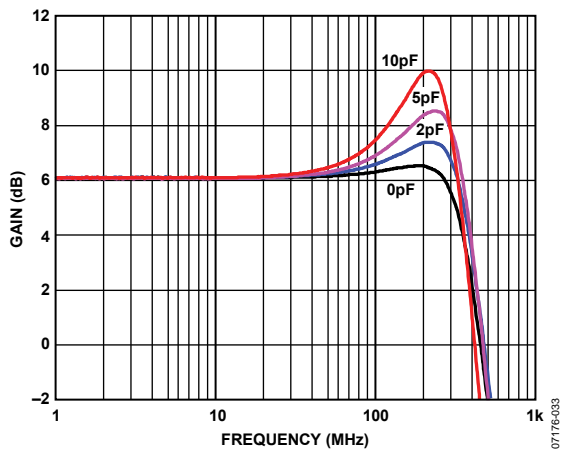

Figure 58. ADV3201 Small Signal Frequency Response with Capacitive Loads, 200 mV p-p

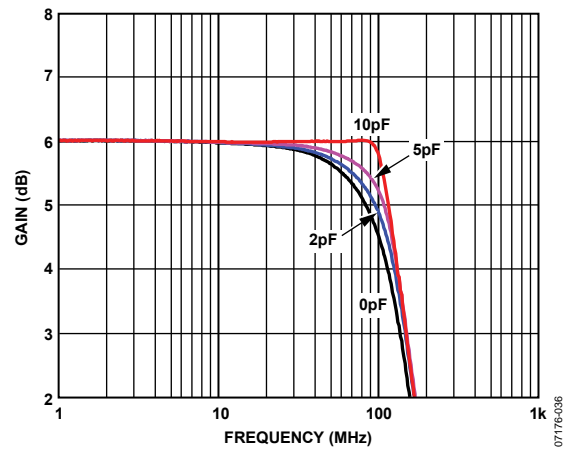

Figure 61. ADV3201 OSD Large Signal Frequency Response with Capacitive Loads, 2 V p-p

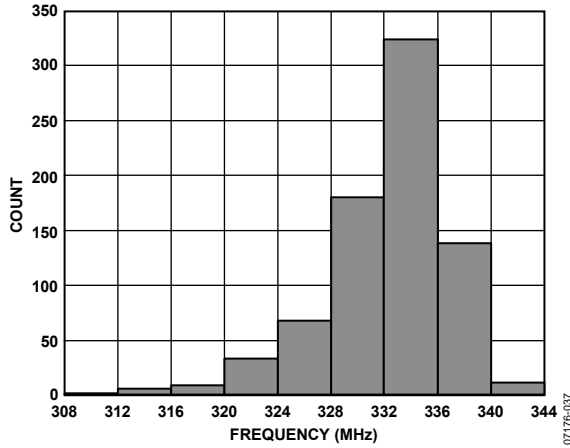

Figure 62. ADV3201 -3 dB Bandwidth Histogram, One Device, All 1024 Channels

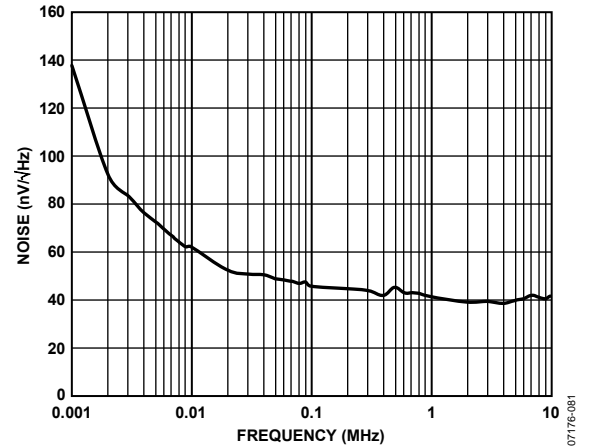

Figure 65. ADV3201 Output Noise

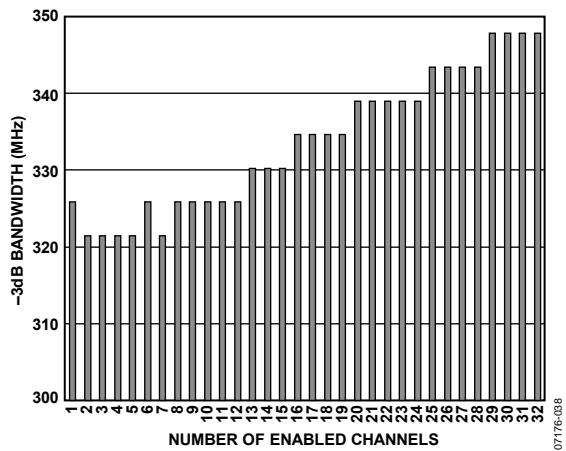

Figure 63. ADV3201 Small Signal Bandwidth vs. Enabled Channels

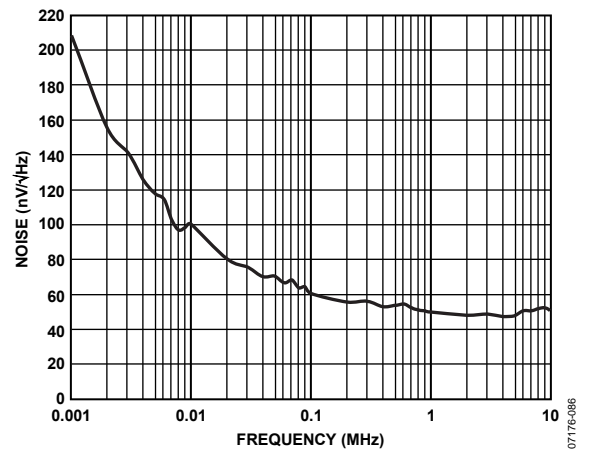

Figure 66. ADV3201 OSD Output Noise

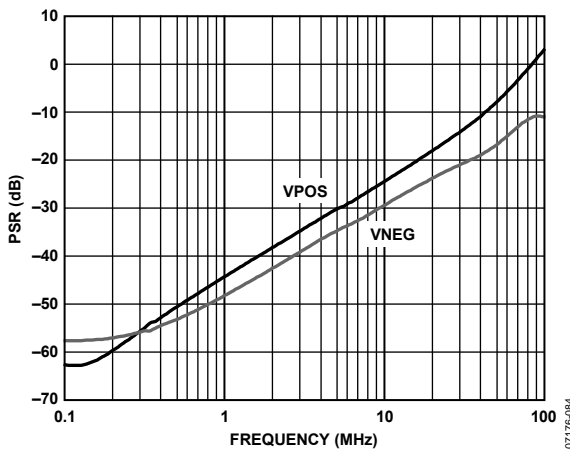

Figure 64. ADV3201 Power Supply Rejection

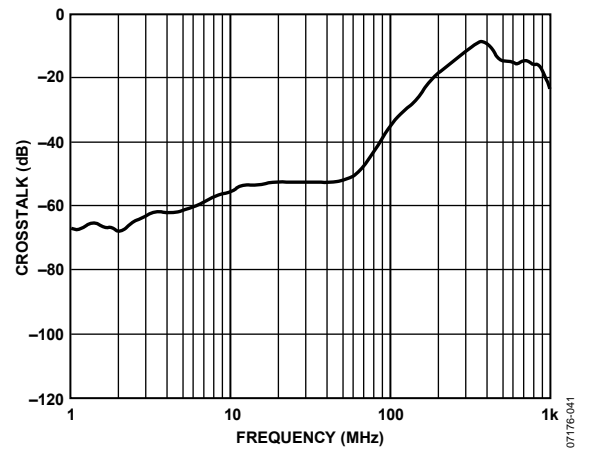

Figure 67. ADV3201 Crosstalk, One Adjacent Channel, RTO

ADV3200/ADV3201

www.DataSheet4U.com

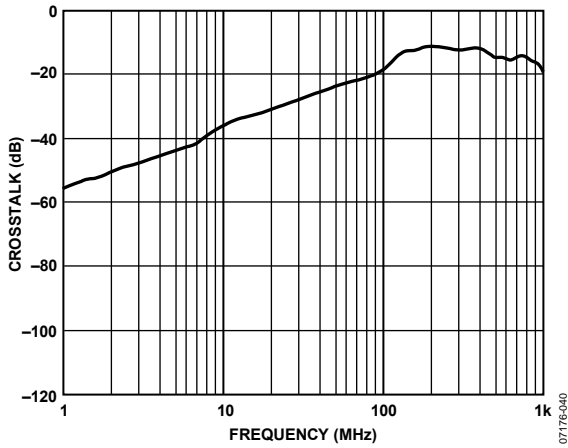

Figure 68. ADV3201 Crosstalk, All Hostile, RTO

07176-040

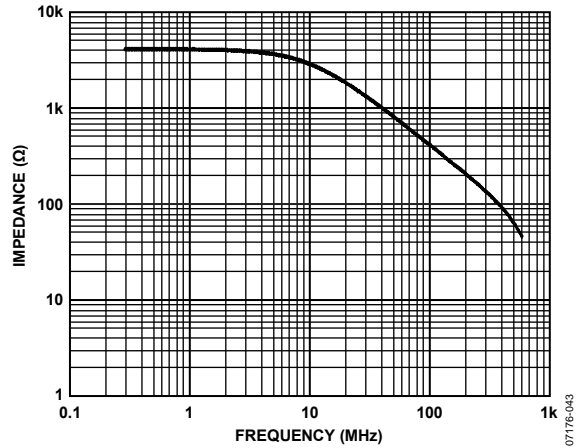

Figure 71. ADV3201 Output Impedance, Disabled

07176-043

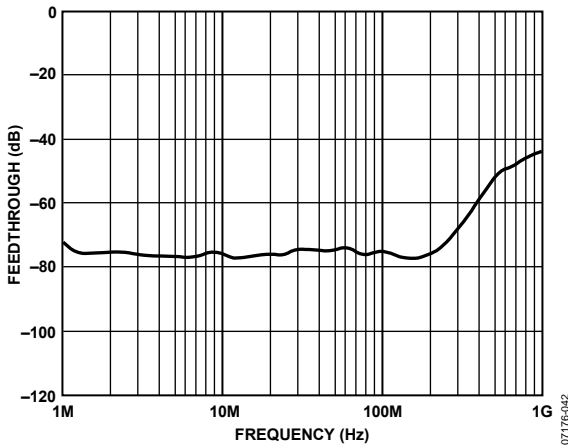

Figure 69. ADV3201 Off Isolation, RTO

07176-042

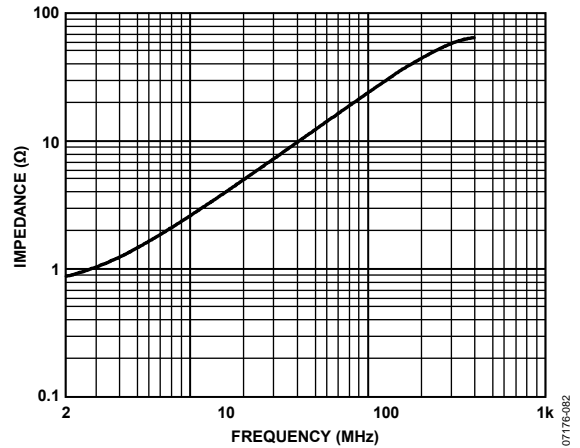

Figure 72. ADV3201 Output Impedance, Enabled

07176-082

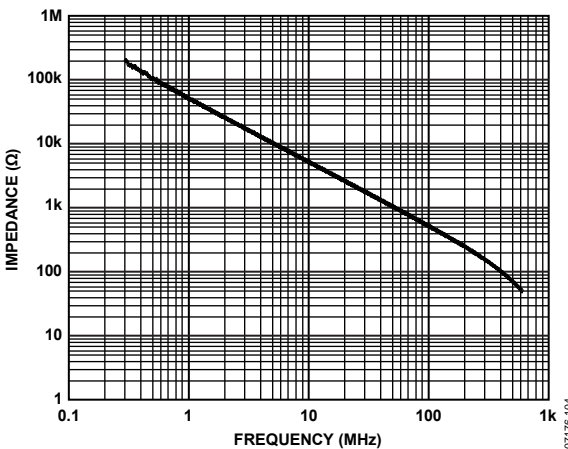

Figure 70. ADV3201 Input Impedance

07176-104

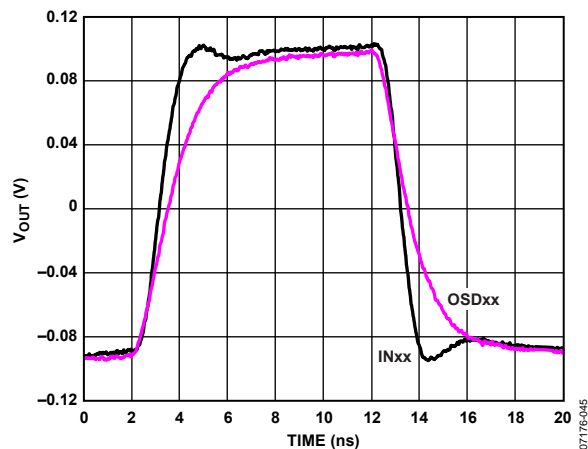

Figure 73. ADV3201 Small Signal Pulse Response, 200 mV p-p

07176-045

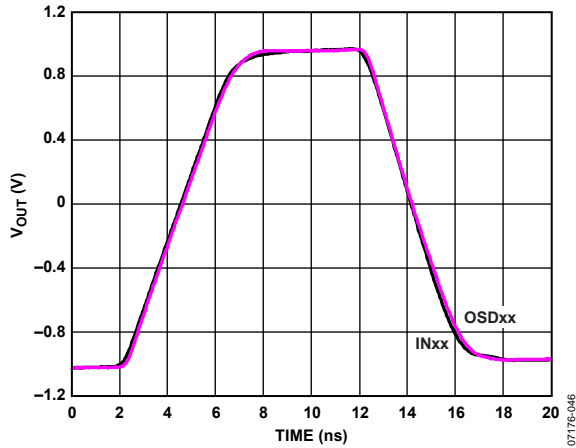

Figure 74. ADV3201 Large Signal Pulse Response, 2 V p-p

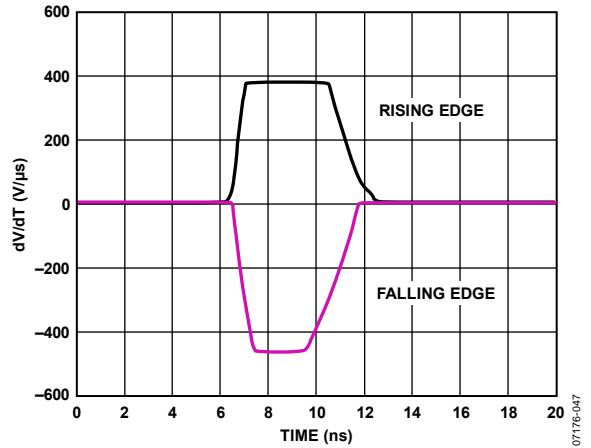

Figure 77. ADV3201 Slew Rate

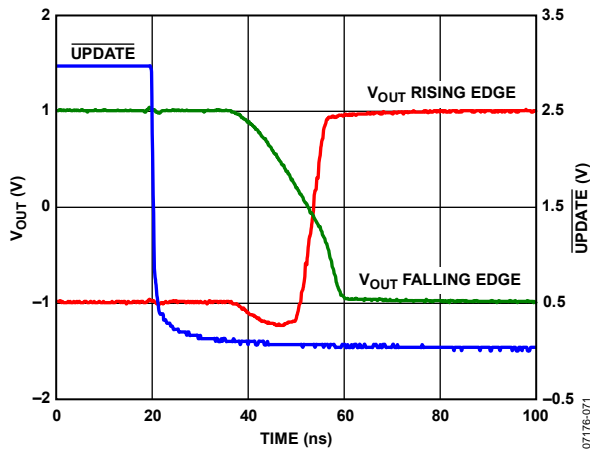

Figure 75. ADV3201 Switching Time

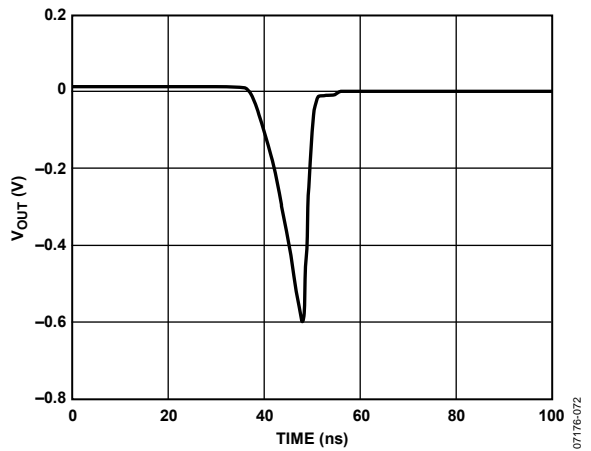

Figure 78. ADV3201 Switching Glitch

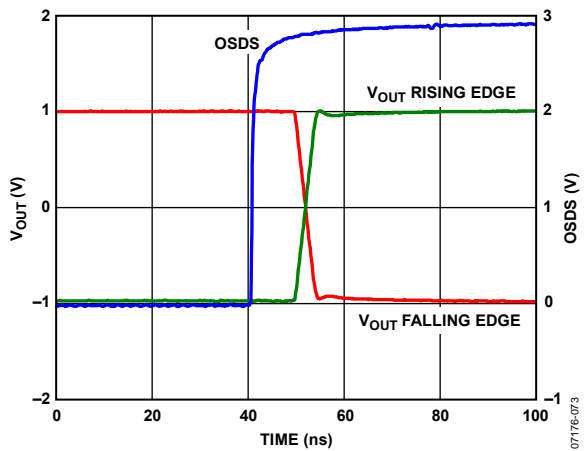

Figure 76. ADV3201 OSD Switching Time

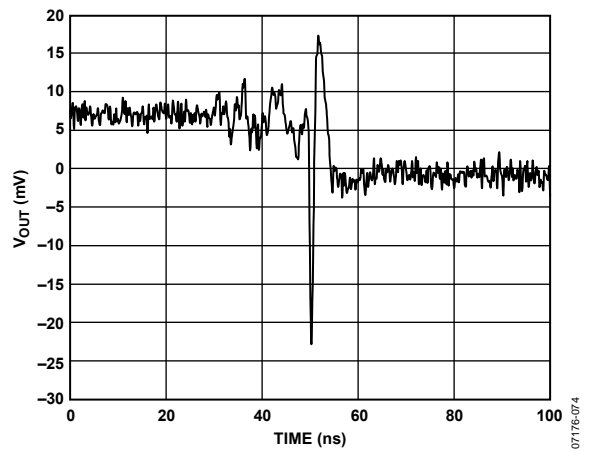

Figure 79. ADV3201 OSD Switching Glitch

ADV3200/ADV3201

www.DataSheet4U.com

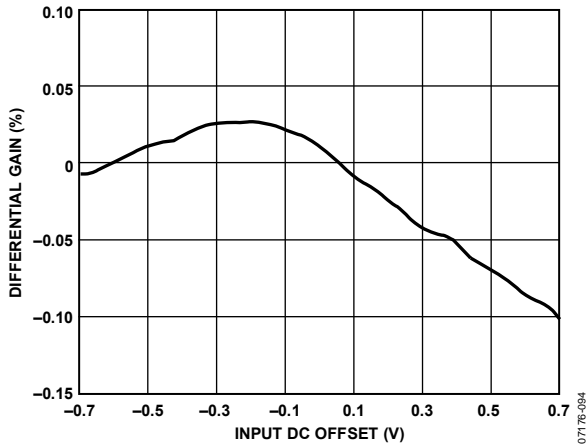

Figure 80. ADV3201 Differential Gain, Carrier Frequency = 3.58 MHz, Subcarrier Amplitude = 300 mV p-p

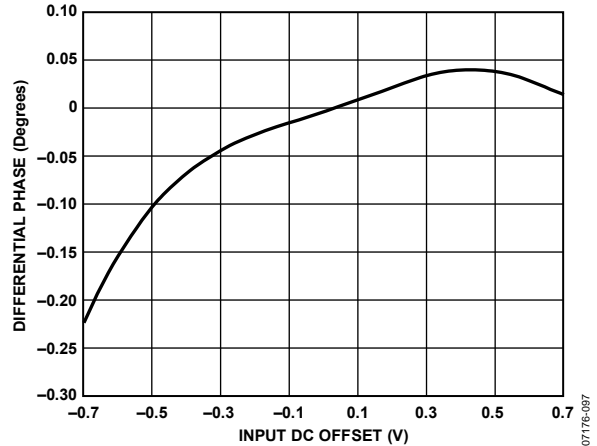

Figure 83. ADV3201 OSD Differential Phase, Carrier Frequency = 3.58 MHz, Subcarrier Amplitude = 300 mV p-p

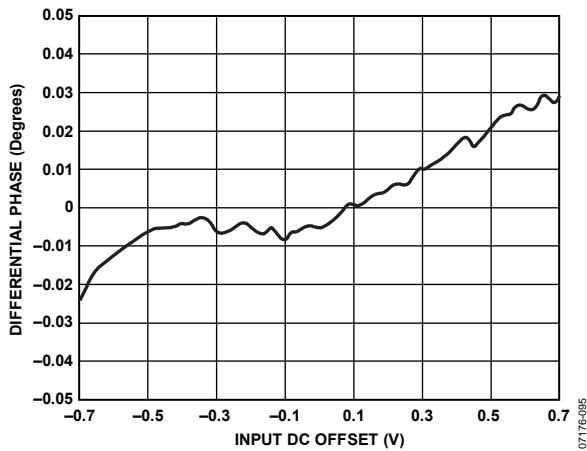

Figure 81. ADV3201 Differential Phase, Carrier Frequency = 3.58 MHz, Subcarrier Amplitude = 300 mV p-p

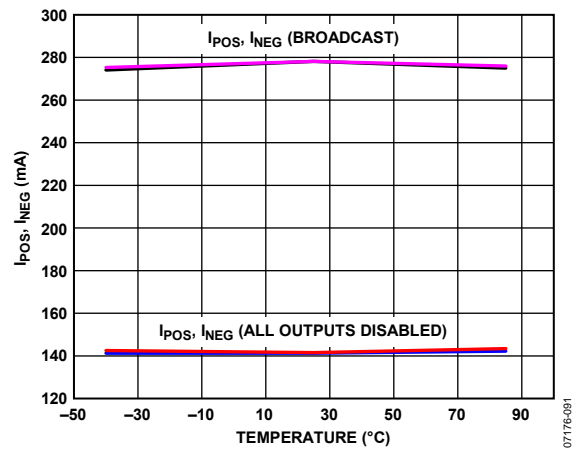

Figure 84. ADV3201 Supply Current vs. Temperature

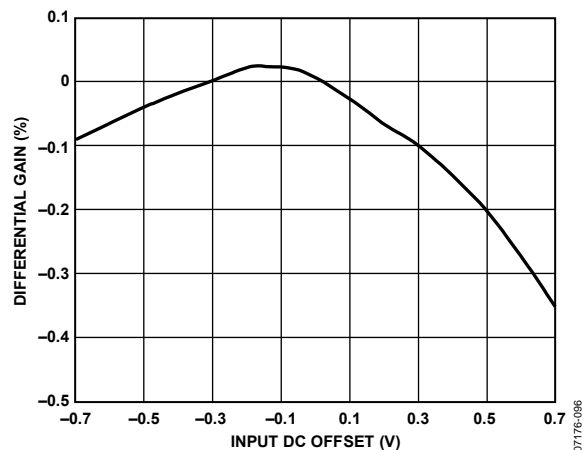

Figure 82. ADV3201 OSD Differential Gain, Carrier Frequency = 3.58 MHz, Subcarrier Amplitude = 300 mV p-p

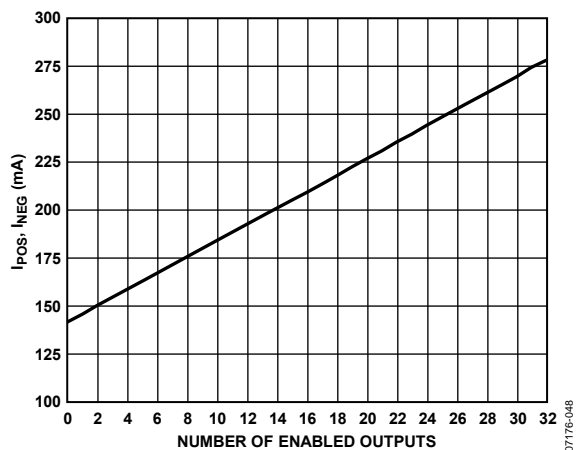

Figure 85. ADV3201 Supply Current vs. Enabled Outputs

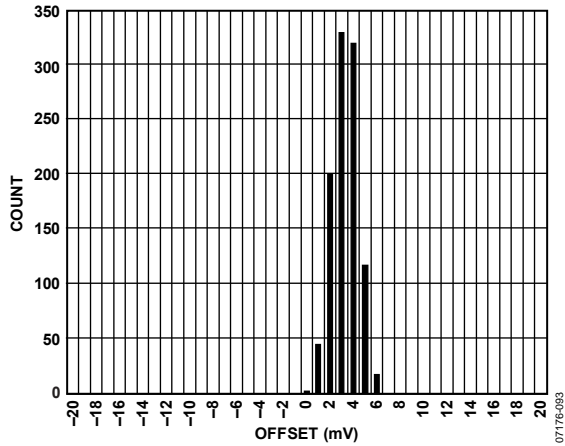

Figure 86. ADV3201 Input Offset Distribution, One Device, All 1024 Channels

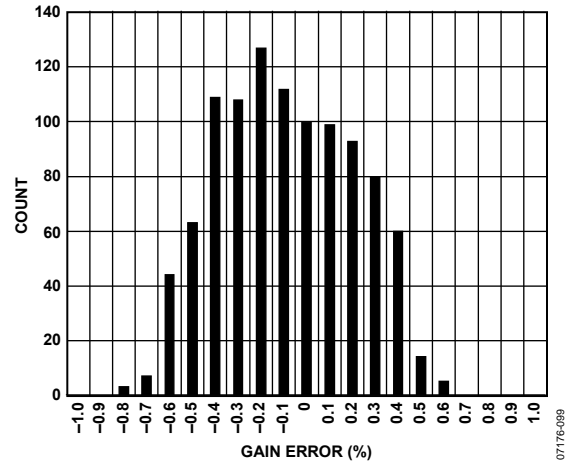

Figure 89. ADV3201 Gain Error Distribution, One Device, All 1024 Channels

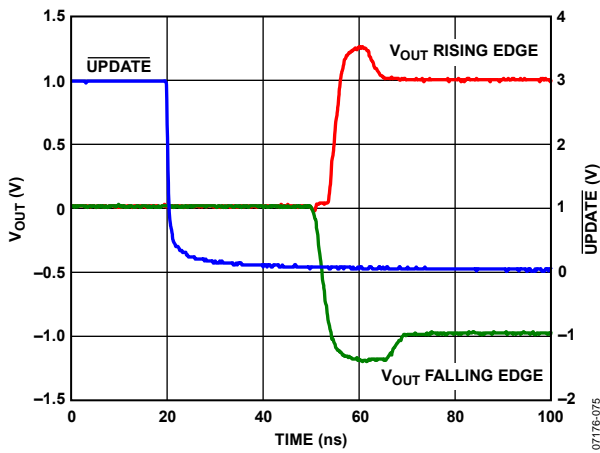

Figure 87. ADV3201 Enable Time

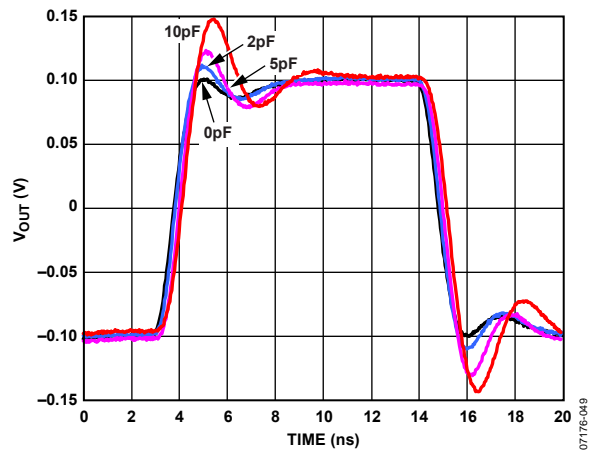

Figure 90. ADV3201 Small Signal Pulse with Capacitive Loads, 200 mV p-p

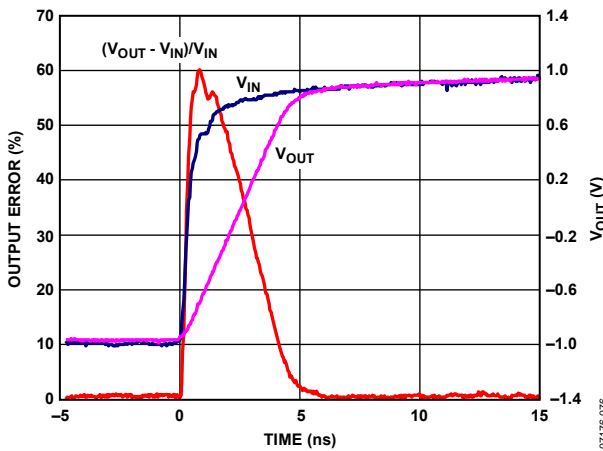

Figure 88. ADV3201 Settling Time

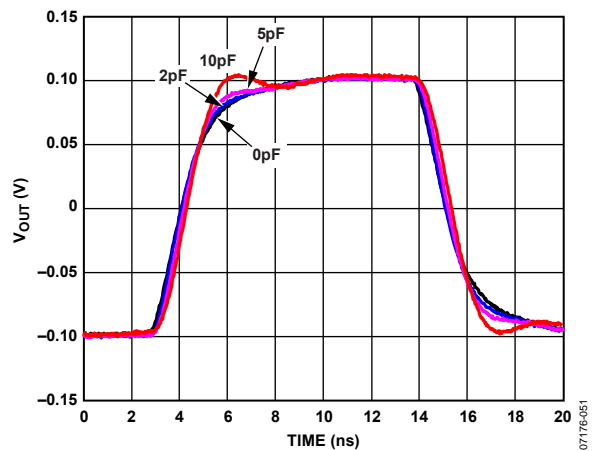

Figure 91. ADV3201 OSD Small Signal Pulse with Capacitive Loads, 200 mV p-p

ADV3200/ADV3201

www.DataSheet4U.com

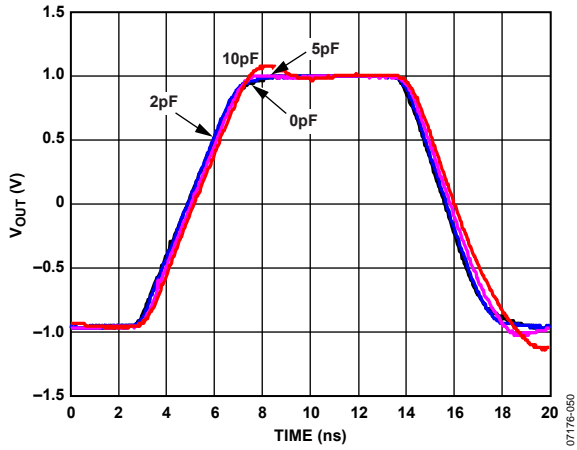

Figure 92. ADV3201 Large Signal Pulse with Capacitive Loads, 2 V p-p

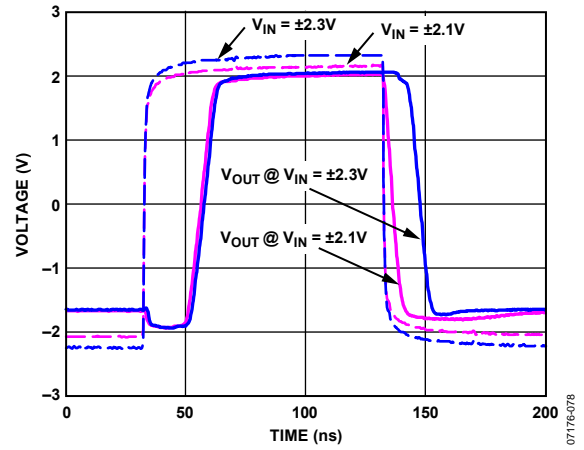

Figure 94. ADV3201 Overdrive Recovery

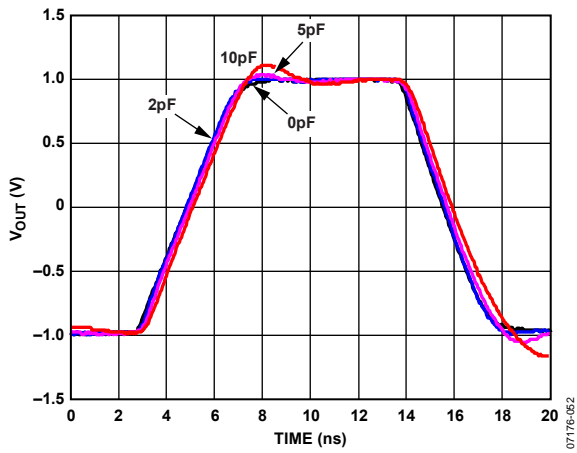

Figure 93. ADV3201 OSD Large Signal Pulse with Capacitive Loads, 2 V p-p

THEORY OF OPERATION

The ADV3200/ADV3201 are single-ended crosspoint arrays with 32 outputs, each of which can be connected to any one of 32 inputs. Thirty-two switchable input stages are connected to each output buffer to form 32-to-1 multiplexers. There are 32 of these multiplexers, each with its inputs wired in parallel, for a total array of 1024 stages forming a multicast-capable crosspoint switch (see Figure 97).

In addition to connecting to any of the nominal inputs (IN_{xx}), each output can also be connected to an associated OSD_{xx} input through an additional 2-to-1 multiplexer at each output. This 2-to-1 multiplexer switches between the output of the 32-to-1 multiplexer and the OSD_{xx} input.

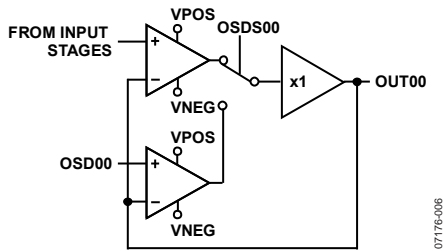

Figure 95. Conceptual Diagram of Single Output Channel, $G = +1$ (ADV3200)

Decoding logic for each output selects one (or none) of the input stages to drive the output stage. The enabled input stage drives the output stage, which is configured as a unity-gain amplifier in the ADV3200 (see Figure 95).

In the ADV3201, an internal resistive feedback network and reference buffer provide for a total output stage gain of +2 (see Figure 96). The input voltage to the reference buffer is the VREF pin. This voltage is common to the entire chip and needs to be driven from a low impedance source to avoid crosstalk.

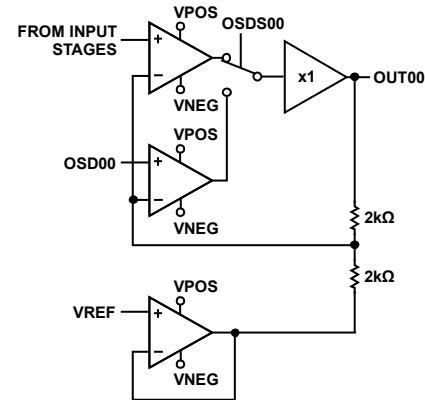

Figure 96. Conceptual Diagram of Single Output Channel, $G = +2$ (ADV3201)

Each input to the ADV3200/ADV3201 is buffered by a receiver. This receiver provides overvoltage protection for the input stages by limiting signal swing. In the ADV3200, the output of the receiver is limited to ± 1.2 V about VREF, whereas in the ADV3201, the signal swing is limited to ± 1.2 V about midsupply. This receiver is configured as a voltage feedback unity-gain amplifier. Excess loop gain bandwidth product reduces the effect of the closed-loop gain on the bandwidth of the device.

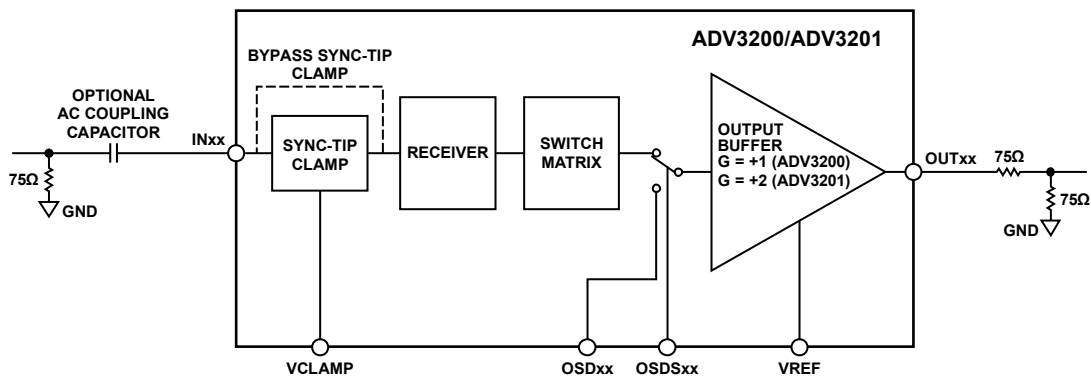

Figure 97. ADV3200/ADV3201 Signal Chain (Single I/O Path)

ADV3200/ADV3201

www.DataSheet4U.com

In addition to a receiver, each input also has a sync-tip clamp for use in ac-coupled applications. All clamps are enabled or disabled according to the first serial data bit shifted in during programming logic. When enabled, the clamp forces the lowest input voltage to the voltage on the VCLAMP pin. The VCLAMP pin is common to the entire chip and needs to be driven from a low impedance source to avoid crosstalk.

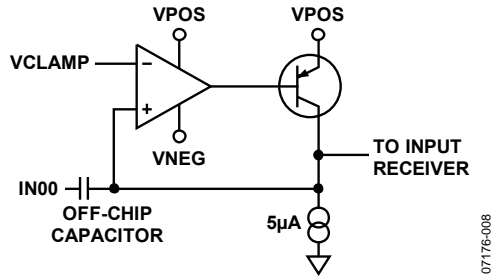

Figure 98. Conceptual Diagram of Sync-Tip Clamp in an AC-Coupled Application

The output stage of the ADV3200/ADV3201 is designed for low differential gain and phase error when driving composite video signals. It also provides slew current for fast pulse response when driving component video signals.

The outputs of the ADV3200/ADV3201 can be disabled to minimize on-chip power dissipation. When disabled, a series of internal amplifiers drives internal nodes such that a wideband high impedance is presented at the disabled output, even when the output bus is under large signal swings. (In the ADV3201, there is 4 k Ω of resistance terminated to the VREF voltage by the reference buffer.) This high impedance allows multiple ICs to be bussed together without additional buffering.

Care must be taken to reduce output capacitance, which results in more overshoot and frequency domain peaking. In addition, when the outputs are disabled and driven externally, the voltage applied to them must not exceed the valid output swing range for the ADV3200/ADV3201 in order to keep these internal amplifiers in their linear range of operation. Applying excess voltage to the disabled outputs can cause damage to the ADV3200/ADV3201 and should be avoided (see the Absolute Maximum Ratings section for guidelines).

The internal connection of the ADV3200/ADV3201 is controlled by a serial logic interface. Serial loading into a first rank of latches preprograms each output. A global update signal (UPDATE) moves the programming data into the second rank of latches, simultaneously updating all outputs. A serial output pin (DATA OUT) allows devices to be daisy chained for single-pin programming of multiple ICs. A reset pin is available to avoid bus conflicts by disabling all outputs. This reset clears both the first and second rank of latches.

The ADV3200 can operate on a single 5 V supply, powering both the signal path (with the VPOS/VNEG supply pins) and the control logic interface (with the DVCC/DGND supply pins). However, in order to easily interface to ground referenced video signals, split supply operation is possible with ± 2.5 V. (The ADV3201 is intended to operate on ± 3.3 V.) In the case of split supplies, a flexible logic interface allows the control logic supplies (DVCC/DGND) to be run off 3.3 V/0 V to 5 V/0 V while the core remains on split supplies.

APPLICATIONS INFORMATION

PROGRAMMING

The ADV3200/ADV3201 are programmed serially through a 193-bit serial word that updates the matrix and the state of the sync-tip clamps each time the part is programmed.

Serial Programming Description

The serial programming mode uses the CLK, DATA IN, UPDATE, and CS device pins. The first step is to assert a low on CS to select the device for programming. The UPDATE signal should be high during the time that data is shifted into the serial port of the device. If UPDATE is low, the data is still shifted in, and the transparent, asynchronous latches allow the data to reach the matrix. This causes the matrix to try to update itself to every intermediate state defined by the shifted-in data.

The data at DATA IN is clocked in at every rising edge of CLK. A total of 193 bits must be shifted in to complete the programming. For each of the 32 outputs, there are five bits (D4 to D0) that determine the source of its input followed by one bit (D5) that determines the enabled state of the output. If D5 is low (output disabled), the five associated bits (D4 to D0) do not matter because no input is switched to that output.

The first bit shifted into the logic is used to enable or disable the sync-tip clamps. If this bit is low, the sync-tip clamps are disabled; otherwise, they are enabled.

The sync-tip clamp bit is shifted in first, followed by the most significant output address data (OUT31). The enable bit (D5) is shifted in first, followed by the input address (D4 to D0) entered sequentially with D4 first and D0 last. Each remaining output is programmed sequentially, until the least significant output address data is shifted in. At this point, UPDATE can be taken low, which causes the device to be programmed according to the data that was just shifted in. The second-rank latches are asynchronous and, when UPDATE is low, they are transparent.

If more than one ADV3200/ADV3201 device is to be serially programmed in a system, the DATA OUT signal from one device can be connected to the DATA IN of the next device to form a serial chain. All of the CLK and UPDATE pins should be connected in parallel and operated as described previously. The serial data is input to the DATA IN pin of the first device of the chain, and it ripples through to the last. Therefore, the data for the last device in the chain should come at the beginning of the programming sequence. The length of the programming sequence is 193 bits multiplied by the number of devices in the chain.

Reset

When powering up the ADV3200/ADV3201, it is usually desirable to have the outputs come up in the disabled state. The RESET pin, when taken low, causes all outputs to be disabled. After power-up, the UPDATE pin should be driven high prior to raising RESET.

Because the data in the shift register is random after power-up, it should not be used to program the matrix, or the matrix can enter unknown states. To prevent this, do not apply a logic low signal to UPDATE initially after power-up. The shift register should first be loaded with the desired data, and then UPDATE can be taken low to program the device.

The RESET pin has a 25 kΩ pull-up resistor to DVCC that can be used to create a simple power-on reset circuit. A capacitor from RESET to ground holds RESET low for some time while the rest of the device stabilizes. The low condition causes all the outputs to be disabled. The capacitor then charges through the pull-up resistor to the high state, thus allowing the full programming capability of the device.

The CS pin has a 25 kΩ pull-down resistor to DGND.

AC COUPLING OF INPUTS

Using ac-coupled inputs presents a challenge for video systems operating from low supply voltages or from a single 5 V supply. In NTSC and PAL video systems, 700 mV is the approximate difference between the maximum signal voltage and the black level, assuming that sync has been stripped. However, as shown in Figure 99, a dynamic range of twice the maximum signal swing is required if the inputs are to be ac-coupled. A solution to this extended requirement for dynamic range is the sync-tip clamp feature.

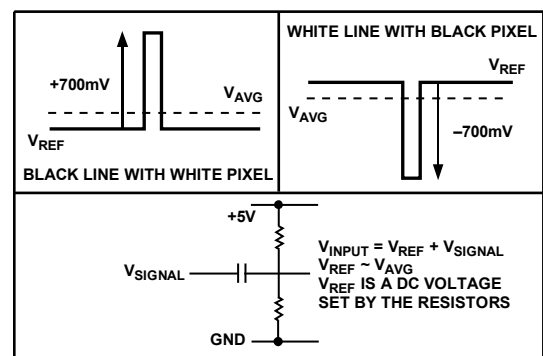

Figure 99. Pathological Case for Input Dynamic Range

Sync-Tip Clamp for AC-Coupled Inputs

The ADV3200/ADV3201 sync-tip clamp, when enabled, clamps the most negative voltage of the video to equal VCLAMP. This provides the correct dc level to the crosspoint switch and ensures that, regardless of average picture level, the dynamic range requirement is only the maximum input signal swing.

A basic method for ac coupling the input is to provide a series capacitor at the input of the ADV3200/ADV3201. If a termination is provided, locate it before the series coupling capacitor. Place the series coupling capacitor as close to the input pin as possible.

It is important to choose the correct value for the ac coupling capacitor at the input to the ADV3200/ADV3201. Too small a value generates unacceptable droop as shown in Figure 100. Using a large enough value, such as a 100 nF ac coupling capacitor, prevents this droop, as shown in Figure 101.

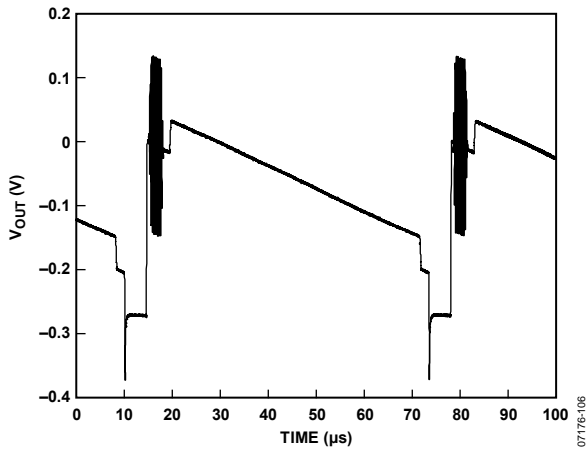

Figure 100. Video Signal with a 1 nF AC Coupling Capacitor

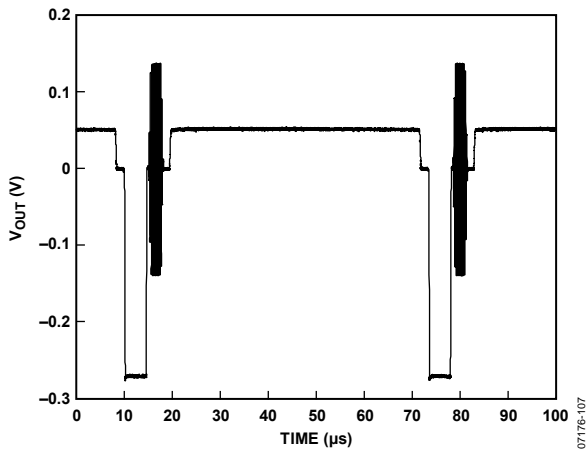

Figure 101. Video Signal with a 100 nF AC Coupling Capacitor

The sync-tip clamp is enabled or disabled by the sync-tip clamp enable bit in the 193-bit word used to serially program the ADV3200/ADV3201. The sync-tip clamp enable bit turns the clamp function on or off for all channels; there is no clamp on/off control for individual channels. The sync-tip clamp function works only with signals that contain sync-tips, such as composite video. Signals that do not have sync-tips appear distorted if they are run through the clamp function.

The range of VCLAMP is -1 V to $+0.3\text{ V}$ for the ADV3200 at $\pm 2.5\text{ V}$ operation, and -0.5 V to $+0.3\text{ V}$ for the ADV3201 at $\pm 3.3\text{ V}$ operation. If driving VCLAMP externally, refer to Figure 14 for the input circuitry. Note that the VCLAMP pin has a $6\text{ k}\Omega$ resistor tied to an on-chip VREF buffered voltage and a $50\text{ }\mu\text{A}$ current source that sets VCLAMP nominally to 300 mV below VREF. It is recommended that bypassing be added on the VCLAMP pin, because noise and offsets can be injected through this pin.

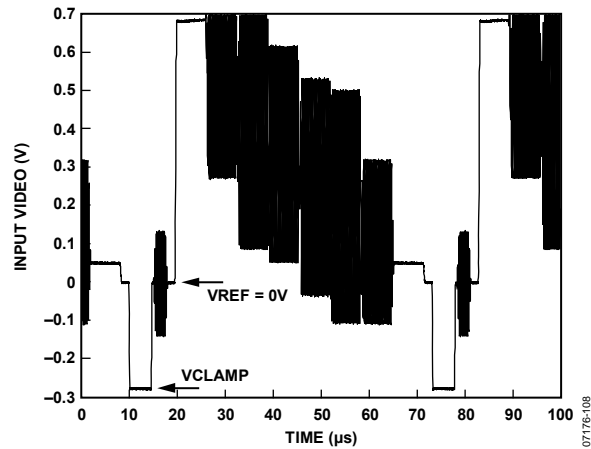

Figure 102. Input Video Signal into Sync-Tip Clamp

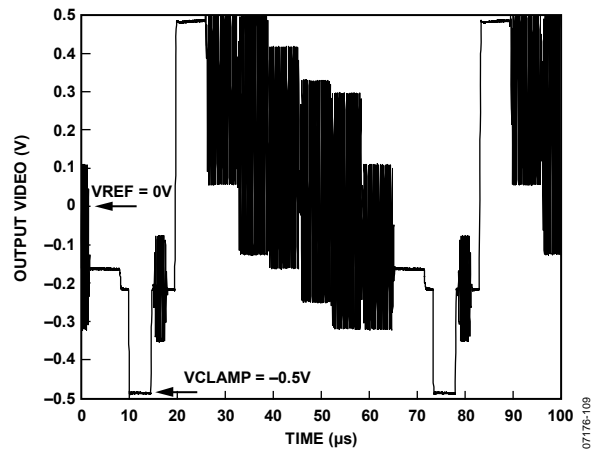

Figure 103. AC-Coupled Video Through ADV3201, Sync-Tip Clamp Enabled

ON-SCREEN DISPLAY (OSD)

The ADV3200/ADV3201 features dedicated 2:1 muxes for each of the 32 outputs that allow external video or dc levels to be inserted and switched in with the regular input channel. The OSD mux switches in 20 ns, allowing for information such as text or other picture-on-picture signals to be displayed. The OSDSxx pins are the control switches used to switch each corresponding OSD mux (high = OSD, low = regular input). Pulling OSDSxx high switches the signal that appears at the OSDxx input to the corresponding output. Setting OSDSxx low switches the signal at INxx to the corresponding output. This switching can be done on a pixel-by-pixel basis for each scan line, and in this way any video signal, including graphics, characters, or text, can be inserted to be displayed at the output. The OSD signal must be synchronized to the incoming video signal that it is switching between; therefore, the OSDS signal must be correctly timed in order to correctly place the OSD signal on the horizontal line. In addition, the OSDxx inputs do not have the sync-tip clamp feature described in the previous section, so the dc level must be set appropriately at the OSDxx input.

DECOUPLING

The signal path of the ADV3200/ADV3201 is based on high open-loop gain amplifiers with negative feedback. Dominant-pole compensation is used on chip to stabilize these amplifiers over the range of expected applied swing and load conditions. To guarantee this designed stability, proper supply decoupling is necessary. Signal-generated currents must return to their sources through low impedance paths at all frequencies in which there is still loop gain (up to 300 MHz at a minimum). A wideband parallel capacitor arrangement is necessary to properly decouple the ADV3200/ADV3201.

The VREF and VCLAMP pins should be considered reference pins, not power supply pins, because they are both inputs to on-chip buffers. Because the VREF pin is used as a ground reference in the ADV3200/ADV3201, care must be taken to produce a low noise VREF source over the entire range of frequencies of interest.

POWER DISSIPATION

Calculation of Power Dissipation

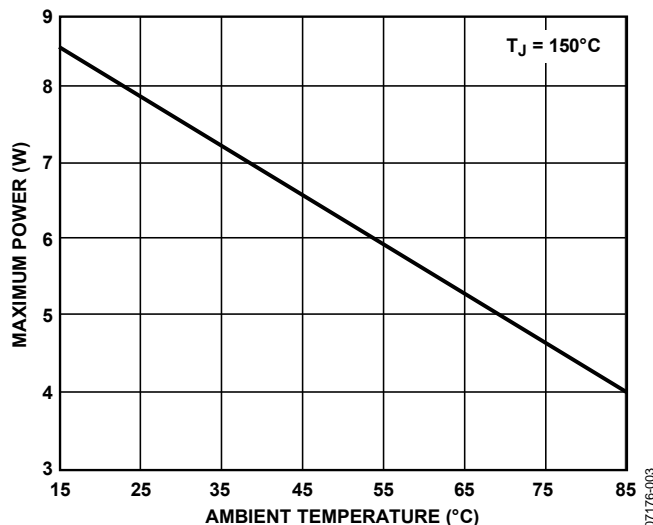

Figure 104. Maximum Die Power Dissipation vs. Ambient Temperature

The curve in Figure 104 is calculated from

$$P_{D,MAX} = \frac{T_{JUNCTION,MAX} - T_{AMBIENT}}{\theta_{JA}} \quad (1)$$

For example, if the ADV3200/ADV3201 is enclosed in an environment at 45°C (T_A), the total on-chip dissipation under all load and supply conditions must not be allowed to exceed 6.5 W.

When calculating on-chip power dissipation, it is necessary to include the rms current being delivered to the load, multiplied by the rms voltage drop on the ADV3200/ADV3201 output devices. For a sinusoidal output, the on-chip power dissipation due to the load can be approximated by

$$P_{D,OUTPUT} = (V_{POS} - V_{OUTPUT,RMS}) \times I_{OUTPUT,RMS} \quad (2)$$

For a nonsinusoidal output, the power dissipation should be calculated by integrating the on-chip voltage drop multiplied by the load current over one period.

The user can subtract the quiescent current for the Class AB output stage when calculating the loaded power dissipation. For each output stage driving a load, subtract the quiescent power according to

$$P_{DQ,OUTPUT} = (V_{POS} - V_{NEG}) \times I_{OUTPUT,QUIESCENT} \quad (3)$$

where $I_{OUTPUT,QUIESCENT} = 0.95$ mA for each single-ended output pin.

For each disabled output, the quiescent power supply current in VPOS and VNEG drops by approximately 4 mA.

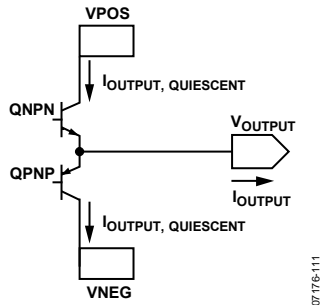

Figure 105. Simplified Output Stage

Example

For the ADV3200, in an ambient temperature of 85°C, with all 32 outputs driving 1 V rms into 150 Ω loads and power supplies at ±2.5 V, follow these steps:

1. Calculate the power dissipation of the ADV3200 using data sheet quiescent currents. Disregard VDD current, which is insignificant.

$$P_{D,QUIESCENT} = (V_{POS} \times I_{V_{POS}}) + (V_{NEG} \times I_{V_{NEG}})$$

$$P_{D,QUIESCENT} = (2.5 \text{ V} \times 250 \text{ mA}) + (2.5 \text{ V} \times 250 \text{ mA}) = 1.25 \text{ W}$$

2. Calculate the power dissipation from the loads.

$$P_{D,OUTPUT} = (V_{POS} - V_{OUTPUT,RMS}) \times I_{OUTPUT,RMS}$$

$$P_{D,OUTPUT} = (2.5 \text{ V} - 1 \text{ V}) \times (1 \text{ V}/150 \Omega) = 10 \text{ mW}$$

There are 32 outputs, therefore, 32 output currents.

$$nP_{D,OUTPUT} = 32 \times 10 \text{ mW} = 0.32 \text{ W}$$

3. Subtract the quiescent output stage current for the number of loads (32 in this example). The output stage is either standing or driving a load, but the current needs to be counted only once (valid for output voltages > 0.5 V).

$$P_{DQ,OUTPUT} = (V_{POS} - V_{NEG}) \times I_{OUTPUT,QUIESCENT}$$

$$P_{DQ,OUTPUT} = (2.5 \text{ V} - (-2.5 \text{ V})) \times (0.95 \text{ mA}) = 4.75 \text{ mW}$$

There are 32 outputs, therefore, 32 output currents.

$$nP_{DQ,OUTPUT} = 32 \times 4.75 \text{ mW} = 0.15 \text{ W}$$

4. Verify that the power dissipation does not exceed the maximum allowed value.

$$P_{D,ON-CHIP} = P_{D,QUIESCENT} + nP_{D,OUTPUT} - nP_{DQ,OUTPUT}$$

$$P_{D,ON-CHIP} = 1.25 \text{ W} + 0.32 \text{ W} - 0.15 \text{ W} = 1.42 \text{ W}$$

As shown in Figure 104 or Equation 1, this power dissipation is below the maximum allowed dissipation for all ambient temperatures up to and including 85°C.

CROSSTALK

Many systems, such as broadcast video and KVM switches, that handle numerous analog signal channels have strict requirements for keeping the various signals from influencing any of the others in the system. Crosstalk is the term used to describe the coupling of the signals of other nearby channels to a given channel.

When there are many signals in close proximity in a system, as is undoubtedly the case in a system that uses the ADV3200/ADV3201, the crosstalk issues can be quite complex. A good understanding of the nature of crosstalk and some definition of terms is required in order to specify a system that uses one or more crosspoint devices.

Types of Crosstalk

Crosstalk can be propagated by any of three means: electric field, magnetic field, and sharing of common impedances. This section explains these effects.

Every conductor can be both a radiator of electric fields and a receiver of electric fields. The electric field crosstalk mechanism occurs when the electric field created by the transmitter propagates across a stray capacitance (for example, free space), couples with the receiver, and induces a voltage. This voltage is an unwanted crosstalk signal in any channel that receives it.

Currents flowing in conductors create magnetic fields that circulate around the currents. These magnetic fields then generate voltages in any other conductors whose paths they link. The undesired induced voltages in these other channels are crosstalk signals. The channels with crosstalk can be said to have a mutual inductance that couples signals from one channel to another.

The power supplies, grounds, and other signal return paths of a multichannel system are generally shared by the various channels. When a current from one channel flows in one of these paths, a voltage that is developed across the impedance becomes an input crosstalk signal for other channels that share the common impedance.

All these sources of crosstalk are vector quantities, so the magnitudes cannot simply be added together to obtain the total crosstalk. In fact, there are conditions where driving additional circuits in parallel in a given configuration can actually reduce the crosstalk.

Areas of Crosstalk

A practical ADV3200/ADV3201 circuit must be mounted to some sort of circuit board in order to connect it to power supplies and measurement equipment. Great care has been taken to create an evaluation board that adds minimum crosstalk to the intrinsic device. This, however, raises the issue that the crosstalk of a system is the combination of the intrinsic crosstalk of the devices and the crosstalk of the circuit board to which the devices are mounted. It is important to separate these two areas when attempting to minimize the effect of crosstalk.

In addition, crosstalk can occur among the inputs to a crosspoint switch and among the outputs. It can also occur from input to output. Techniques are discussed in the following sections for diagnosing which part of a system is contributing to crosstalk.

Measuring Crosstalk

Crosstalk is measured by applying a signal to one or more channels and measuring the relative strength of that signal on a desired selected channel. The measurement is usually expressed as decibels below the magnitude of the test signal. The crosstalk is expressed by

$$|XT| = 20 \log_{10} \left(\frac{A_{SEL}(s)}{A_{TEST}(s)} \right) \quad (4)$$

where:

$s = j\omega$ (Laplace transform variable).

$A_{SEL}(s)$ is the amplitude of the crosstalk induced signal in the selected channel.

$A_{TEST}(s)$ is the amplitude of the test signal.

It can be seen that crosstalk is a function of frequency but not a function of the magnitude of the test signal (to first order). In addition, the crosstalk signal has a phase relative to the test signal associated with it.

A network analyzer is most commonly used to measure crosstalk over a frequency range of interest. It can provide both magnitude and phase information about the crosstalk signal.

As a crosspoint system or device grows larger, the number of theoretical crosstalk combinations and permutations can become extremely large. For example, in the case of the 32×32 matrix of the ADV3200/ADV3201, note the number of crosstalk terms that can be considered for a single channel, for example, the IN00 input. IN00 is programmed to connect to one of the ADV3200/ADV3201 outputs where the measurement can be made.

First, the crosstalk terms associated with driving a test signal into each of the other 31 inputs can be measured one at a time, while applying no signal to IN00. Then the crosstalk terms associated with driving a parallel test signal into all 31 other inputs can be measured two at a time in all possible combinations, then three at a time, and so on until, finally, there is only one way to drive a test signal into all 31 other inputs in parallel.

Each of these cases is legitimately different from the others and may yield a unique value, depending on the resolution of the measurement system, but it is hardly practical to measure all these terms and then specify them. In addition, this describes the crosstalk matrix for just one input channel. A similar crosstalk matrix can be proposed for every other input. In addition, if the possible combinations and permutations for connecting inputs to the other outputs (not used for measurement) are taken into consideration, the numbers quickly grow to astronomical proportions. If a larger crosspoint array of multiple ADV3200/ADV3201 devices is constructed, the numbers grow larger still.

Obviously, some subset of all these cases must be selected as a guide for a practical measurement of crosstalk. One common method is to measure all hostile crosstalk; this means that the crosstalk to the selected channel is measured while all other

system channels are driven in parallel. In general, this yields the worst crosstalk number, but this is not always the case due to the vector nature of the crosstalk signal.

Other useful crosstalk measurements are those created by one nearest neighbor or by the two nearest neighbors on either side. These crosstalk measurements are generally higher than those of more distant channels; therefore, they can serve as a worst-case measure for any other one-channel or two-channel crosstalk measurements.

Input and Output Crosstalk

Capacitive coupling is voltage-driven (dV/dt) but is generally a constant ratio. Capacitive crosstalk is proportional to input or output voltage, but this ratio is not reduced by simply reducing signal swings. Attenuation factors must be changed by changing impedances (lowering mutual capacitance), or destructive canceling must be utilized by summing equal and out of phase components. For high input impedance devices such as the ADV3200/ADV3201, capacitances generally dominate input-generated crosstalk.

Inductive coupling is proportional to current (dI/dt) and often scales as a constant ratio with signal voltage, but it also shows a dependence on impedances (load current). Inductive coupling can also be reduced by constructive canceling of equal and out of phase fields. In the case of driving low impedance video loads, output inductances contribute highly to output crosstalk.

The flexible programming capability of the ADV3200/ADV3201 can be used to diagnose whether crosstalk is occurring more on the input side or the output side. Some examples are illustrative. A given input pair (IN07 in the middle for this example) can be programmed to drive OUT07 (also in the middle). The inputs to IN07 are terminated to ground (via 50Ω or 75Ω resistors) and no signal is applied.

All the other inputs are driven in parallel with the same test signal (practically provided by a distribution amplifier), with all other outputs except OUT07 disabled. Because the grounded IN07 input is programmed to drive OUT07, no signal should be present. Any signal that is present can be attributed to the other 15 hostile input signals because no other outputs are driven (they are all disabled). Thus, this method measures all the hostile input contribution to crosstalk into IN07. Of course, this method can be used for other input channels and combinations of hostile inputs.

For output crosstalk measurement, a single input channel is driven (IN00, for example) and all outputs other than a given output (IN07 in the middle) are programmed to connect to IN00. OUT07 is programmed to connect to IN15 (far away from IN00), which is terminated to ground. Thus OUT07 should not have a signal present because it is listening to a quiet input. Any signal measured at OUT07 can be attributed to the output crosstalk of the other 15 hostile outputs. Again, this method can be modified to measure other channels and other crosspoint matrix combinations.

Effect of Impedances on Crosstalk

Input side crosstalk can be influenced by the output impedance of the sources that drive the inputs. The lower the impedance of the drive source, the lower the magnitude of the crosstalk. The dominant crosstalk mechanism on the input side is capacitive coupling. The high impedance inputs do not have significant current flow to create magnetically induced crosstalk. However, significant current can flow through the input termination resistors and the loops that drive them. Thus, the PCB on the input side can contribute to magnetically coupled crosstalk.

From a circuit standpoint, the input crosstalk mechanism looks like a capacitor coupling to a resistive load. For low frequencies, the magnitude of the crosstalk is given by

$$|XT| = 20 \log_{10} [(R_S C_M) \times s] \quad (5)$$

where:

R_S is the source resistance.

C_M is the mutual capacitance between the test signal circuit and the selected circuit.

s is the Laplace transform variable.

From the preceding equation, it can be observed that this crosstalk mechanism has a high-pass nature; it can also be minimized by reducing the coupling capacitance of the input circuits and lowering the output impedance of the drivers. If the input is driven from a 75 Ω terminated cable, the input crosstalk can be reduced by buffering this signal with a low output impedance buffer.

On the output side, the crosstalk can be reduced by driving a lighter load. Although the ADV3200/ADV3201 are specified with excellent differential gain and phase when driving a standard 150 Ω video load, the crosstalk will be higher than the minimum obtainable due to the high output currents. These currents induce crosstalk via the mutual inductance of the output pins and bond wires of the ADV3200/ADV3201.

From a circuit standpoint, the output crosstalk mechanism looks like a transformer with a mutual inductance between the windings that drives a load resistor. For low frequencies, the magnitude of the crosstalk is given by

$$|XT| = 20 \log_{10} \left(M_{XY} \times \frac{s}{R_L} \right) \quad (6)$$

where:

M_{XY} is the mutual inductance of Output X to Output Y.

R_L is the load resistance on the measured output.

s is the Laplace transform variable.

This crosstalk mechanism can be minimized by keeping the mutual inductance low and increasing R_L . The mutual inductance can be kept low by increasing the spacing of the conductors and minimizing their parallel length.

PCB Layout

Extreme care must be exercised to minimize additional crosstalk generated by system circuit boards. The areas that

must be carefully detailed are grounding, shielding, signal routing, and supply bypassing.

The input and output signals have minimum crosstalk if they are located between ground planes on layers above and below and are separated by ground in between. Locate vias as close to the IC as possible to carry the inputs and outputs to the inner layer. The input and output signals surface at the input termination resistors and the output series back-termination resistors. To the extent possible, separate these signals as soon as they emerge from the IC package.

PCB TERMINATION LAYOUT

As frequencies of operation increase, proper routing of transmission line signals becomes more important. The bandwidth of the ADV3200/ADV3201 is large enough so that using high impedance routing does not provide a flat in-band frequency response for practical signal trace lengths. It is necessary for the user to choose a characteristic impedance suitable for the application and to properly terminate the input and output signals of the ADV3200/ADV3201. Traditionally, video applications use 75 Ω single-ended environments.

For flexibility, the ADV3200/ADV3201 does not contain on-chip termination resistors. This flexibility in application comes with some board layout challenges. The distance between the termination of the input transmission line and the ADV3200/ADV3201 die is a high impedance stub and causes reflections of the input signal. With some simplification, it can be shown that these reflections cause peaking of the input at regular intervals in frequency, dependent on the propagation speed (v_P) of the signal in the chosen board material and the distance (d) between the termination resistor and the ADV3200/ADV3201. If the distance is great enough, these peaks can occur in band. In fact, practical experience shows that these peaks are not high-Q, and should be pushed out to three or four times the desired bandwidth in order to not have an effect on the signal. For a board designer using FR4 ($v_P = 144 \times 10^6$ m/s), this means that the ADV3200/ADV3201 input should be placed no farther than 2 cm after the termination resistors and, preferably, should be placed even closer. Therefore, 2 cm PCB routing equates to $d = 2 \times 10^{-2}$ m in the calculations.

$$f_{PEAK} = \frac{(2n+1) \times v_P}{4d} \quad (7)$$

where $n = \{0, 1, 2, 3, \dots\}$.

In some cases, it is difficult to place the termination close to the ADV3200/ADV3201 due to space constraints and large resistor footprints. A better solution in this case is to maintain a controlled transmission line past the ADV3200/ADV3201 inputs and to terminate the end of the line. This method is known as fly-by termination. The input impedance of the ADV3200/ADV3201 is large enough, and the stub length inside the package is small enough, that this works well in practice.

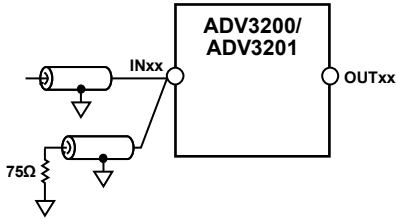

Figure 106. Fly-By Input Termination (Grounds for the Two Transmission Lines Must Be Tied Together Close to the INxx Pin)

If multiple ADV3200/ADV3201s are to be driven in parallel, a fly-by input termination scheme is very useful, but the distance from each ADV3200/ADV3201 input to the driven input

transmission line is a stub that should be minimized in length and parasitics using the discussed guidelines.

Although the examples discussed so far are for input termination, the theory is similar for output back termination. Taking the ADV3200/ADV3201 as an ideal voltage source, any distance of routing between the ADV3200/ADV3201 and a back-termination resistor is a stub that creates reflections. For this reason, place back-termination resistors close to the ADV3200/ADV3201. In practice, because back-termination resistors are series elements, their footprint in the routing is narrower, and it is easier to place them close to the ADV3200/ ADV3201 outputs in board layout.

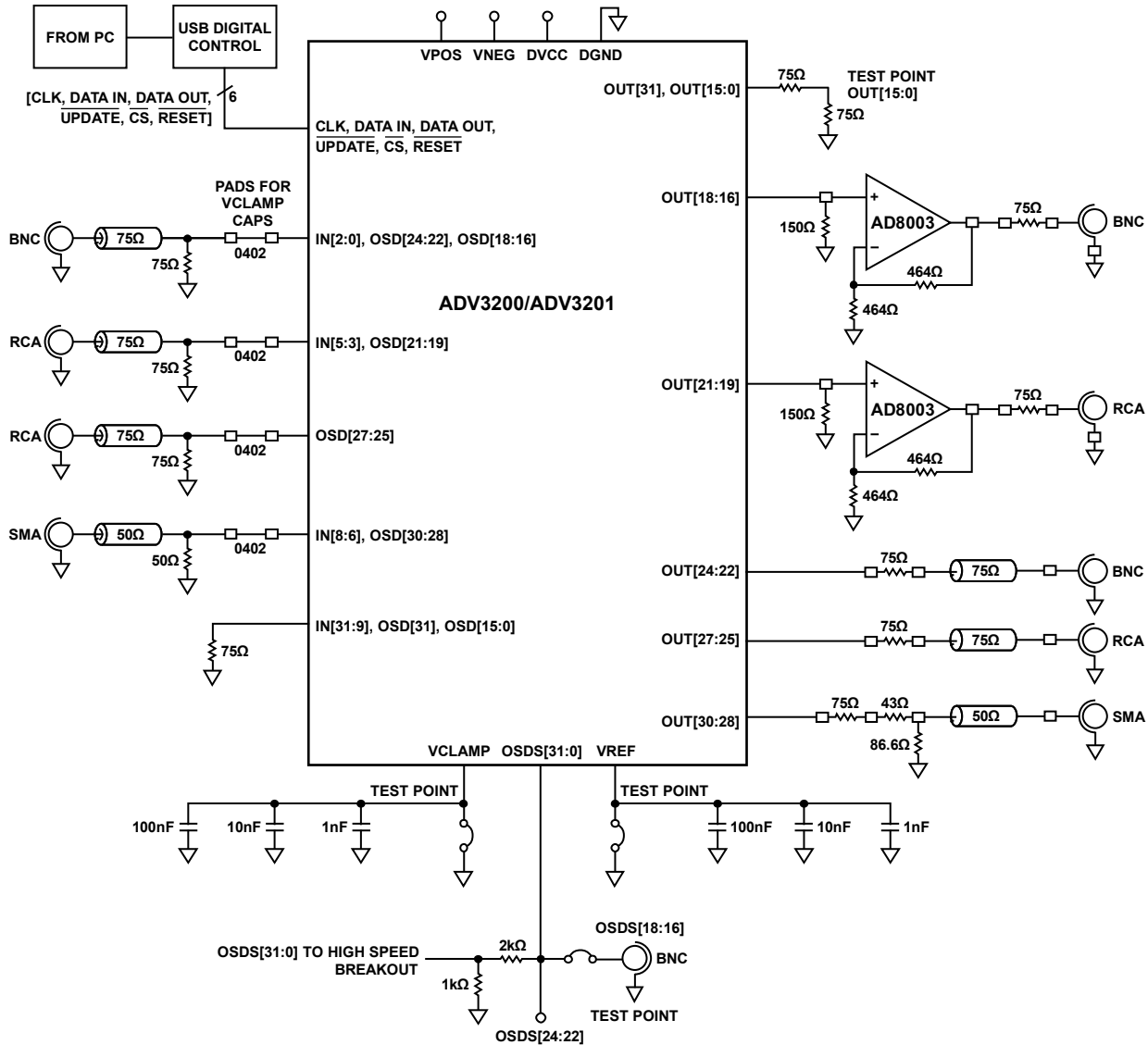
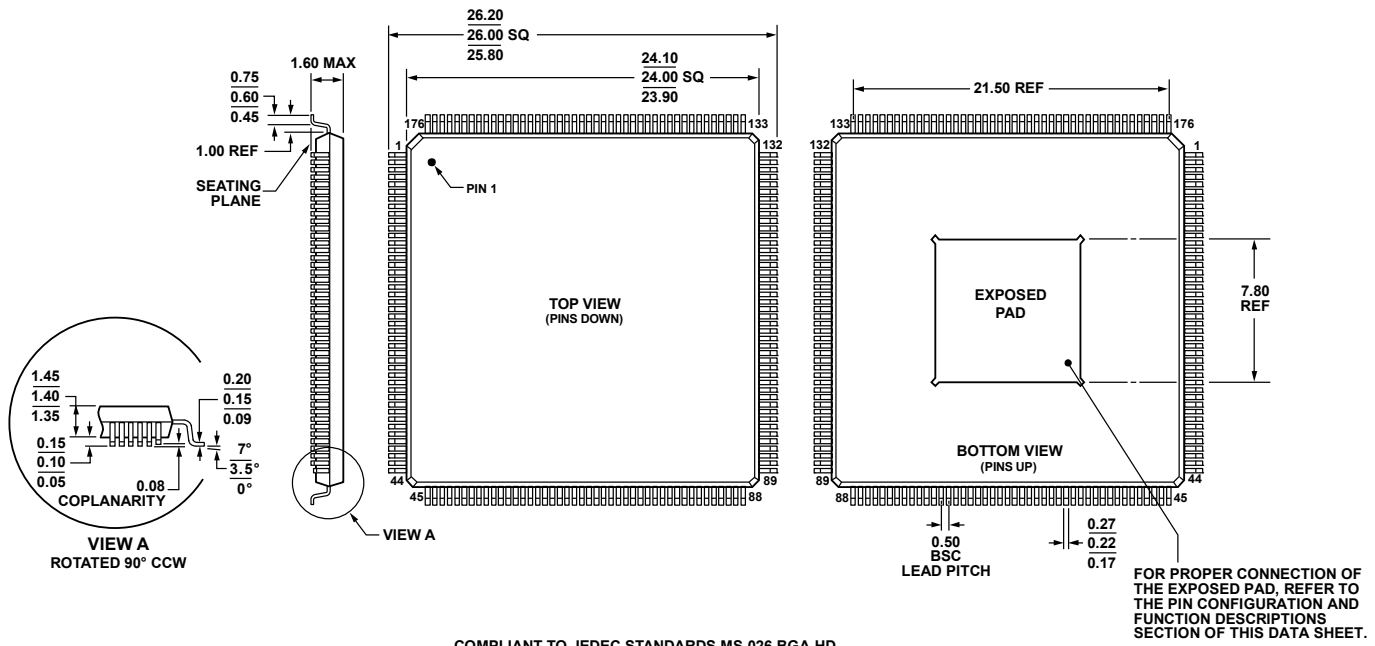

Figure 107. Evaluation Board Simplified Schematic

OUTLINE DIMENSIONS



COMPLIANT TO JEDEC STANDARDS MS-026-BGA-HD

Figure 108. 176-Lead Low Profile Quad Flat Package [LQFP_EP] (SW-176-1)

Dimensions shown in millimeters

081808-A

ORDERING GUIDE

Model	Temperature Range	Package Description	Package Option
ADV3200ASWZ ¹	-40°C to +85°C	176-Lead Low Profile Quad Flat Package [LQFP_EP]	SW-176-1
ADV3201ASWZ ¹	-40°C to +85°C	176-Lead Low Profile Quad Flat Package [LQFP_EP]	SW-176-1

¹ Z = RoHS Compliant Part.