

# DATA SHEET

## **TDA8505** SECAM encoder

Preliminary specification  
Supersedes data of May 1993  
File under Integrated Circuits, IC02

July 1994

**Philips Semiconductors**



**PHILIPS**

**SECAM encoder****TDA8505****FEATURES**

- Two input stages, R, G, B and Y,  $-(R-Y)$ ,  $-(B-Y)$  with multiplexing.
- Chrominance processing, highly integrated, includes vertical identification, low frequency pre-emphasis and high frequency pre-emphasis (anti-Cloche) and bandpass filter.
- Fully controlled FM modulator which produces a signal in accordance with the SECAM standard without adjustments.
- Two reference oscillators, one for D'R  $f_0$  (4.40625 MHz) and one for D'B  $f_0$  (4.250 MHz). These oscillators are tuned by PLL loop with the frequency of the line sync as reference. Crystal tuning, or tuning by external reference source, of the reference oscillators is possible.
- Output stages, CVBS and separated Y + SYNC and CHROMA. For CVBS output, signal amplitude 2 V (p-p) nominal, thus only an external emitter follower is required for 75  $\Omega$  driving.
- Sync separator circuit and pulse shaper, to generate the required pulses for the processing, line, frame, FH/2 and chrominance blanking.
- A 3-level sandcastle pulse is generated for PAL/NTSC to SECAM transcoding.
- FH/2 input for locking with another decoder.
- Colour killing on the internal colour difference signals.
- Internal bandgap reference.

**GENERAL DESCRIPTION**

The TDA8505 is a highly integrated SECAM encoding IC that is designed for use in all applications that require transformation of R, G and B signals or Y, U and V signals to a standard SECAM signal.

The specification of the input signals is fully compatible with those of the TDA8501 PAL/NTSC encoder.

**ORDERING INFORMATION**

TYPE NUMBER	PACKAGE			
	PINS	PIN POSITION	MATERIAL	CODE
TDA8505	32	SDIP32	plastic	SOT232-1

# SECAM encoder

# TDA8505

## BLOCK DIAGRAM

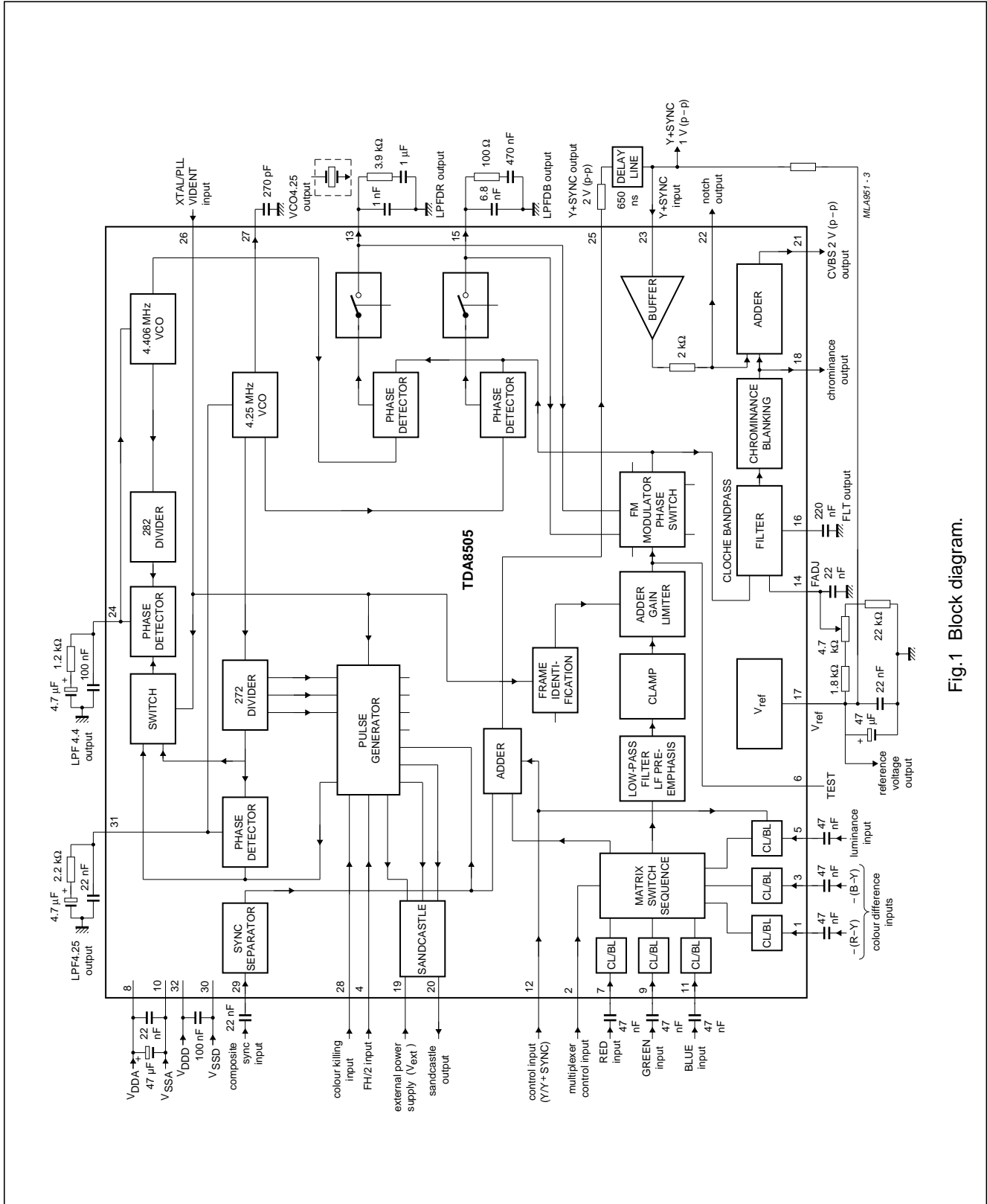

Fig.1 Block diagram.

## SECAM encoder

TDA8505

**PINNING**

D'R and D'B are the colour difference signals at the output of the multiplexer circuit;  $D'R = -1.9(R-Y)$  and  $D'B = +1.5(B-Y)$ , for an EBU bar of 75% the amplitudes are equal.

SYMBOL	PIN	DESCRIPTION
$-(R-Y)$	1	colour difference input signal, for EBU bar of 75% 1.05 V (peak-to-peak value)
MCONTR	2	multiplexer control; input HIGH = RGB, input LOW = $-(R-Y)$ , $-(B-Y)$ and Y
$-(B-Y)$	3	colour difference input signal, for EBU bar of 75% 1.33 V (peak-to-peak value)
FH/2	4	line pulse input divided-by-2 for synchronizing two or more encoders; when not used this pin is connected to ground
Y	5	luminance input signal 1 V nominal without sync
TEST	6	test pin; must be connected to $V_{CC}$ (pin 8), or left open-circuit
R	7	RED input signal for EBU bar of 75% 0.7 V (peak-to-peak value)
$V_{DDA}$	8	analog supply voltage for encoder part; 5 V nominal
G	9	GREEN input signal for EBU bar of 75% 0.7 V (peak-to-peak value)
$V_{SSA}$	10	analog ground
B	11	BLUE input signal for EBU bar of 75% 0.7 V (peak-to-peak value)
Y/Y+SYNC	12	when this control input is LOW, Y without sync is connected to pin 5, input blanking at pin 5 is active; when input is HIGH, Y+SYNC is connected to pin 5, input blanking at pin 5 is not active
LPFDR	13	modulator control loop filter output; black level of D'R = 4.40625 MHz
FADJ	14	adjustment pin for 4.286 MHz of HF pre-emphasis filter
LPFDB	15	modulator control loop filter output; black level of D'B = 4.250 MHz
FLT	16	filter tuning loop capacitor output
$V_{ref}$	17	2.5 V internal reference voltage output
CHROMA	18	chrominance output, amplitude corresponds with Y+SYNC at the output of the delay line
$V_{ext}$	19	external power supply for sandcastle generation; when not used this pin is connected to ground
SAND	20	3-level sandcastle output pulse
CVBS	21	composite SECAM output 2 V (peak-to-peak value) nominal
NOTCH	22	Y+SYNC output after an internal resistor of 2 k $\Omega$ ; a notch filter can be connected
Y+SYNC IN	23	Y+SYNC input, connected to the output of the delay line
LPF4.4	24	loop filter output for 4.40625 MHz reference oscillator
Y+SYNC OUT	25	Y+SYNC output, 2 V (peak-to-peak value) nominal, connected to the input of the delay line
XTAL/PLL VIDENT	26	control pin; input HIGH = crystal tuning, input LOW = PLL tuning, both <b>without</b> vertical identification, 2.5 V = PLL tuning <b>with</b> vertical identification
VCO4.25	27	when used for PLL tuning a capacitor is connected; when used for crystal tuning a crystal has to be connected (in series with a capacitor)
COLKIL	28	colour killing; input HIGH = active, internal colour difference signals are blanked
CS	29	composite sync input, 0.3 V (peak-to-peak value) nominal

SECAM encoder

TDA8505

SYMBOL	PIN	DESCRIPTION
V <sub>SSD</sub>	30	digital ground
LPF4.25	31	loop filter output for 4.25 MHz reference oscillator; connected to pin 17 (V <sub>ref</sub> ) when external tuning by crystal or signal source
V <sub>DDD</sub>	32	supply voltage for the digital part

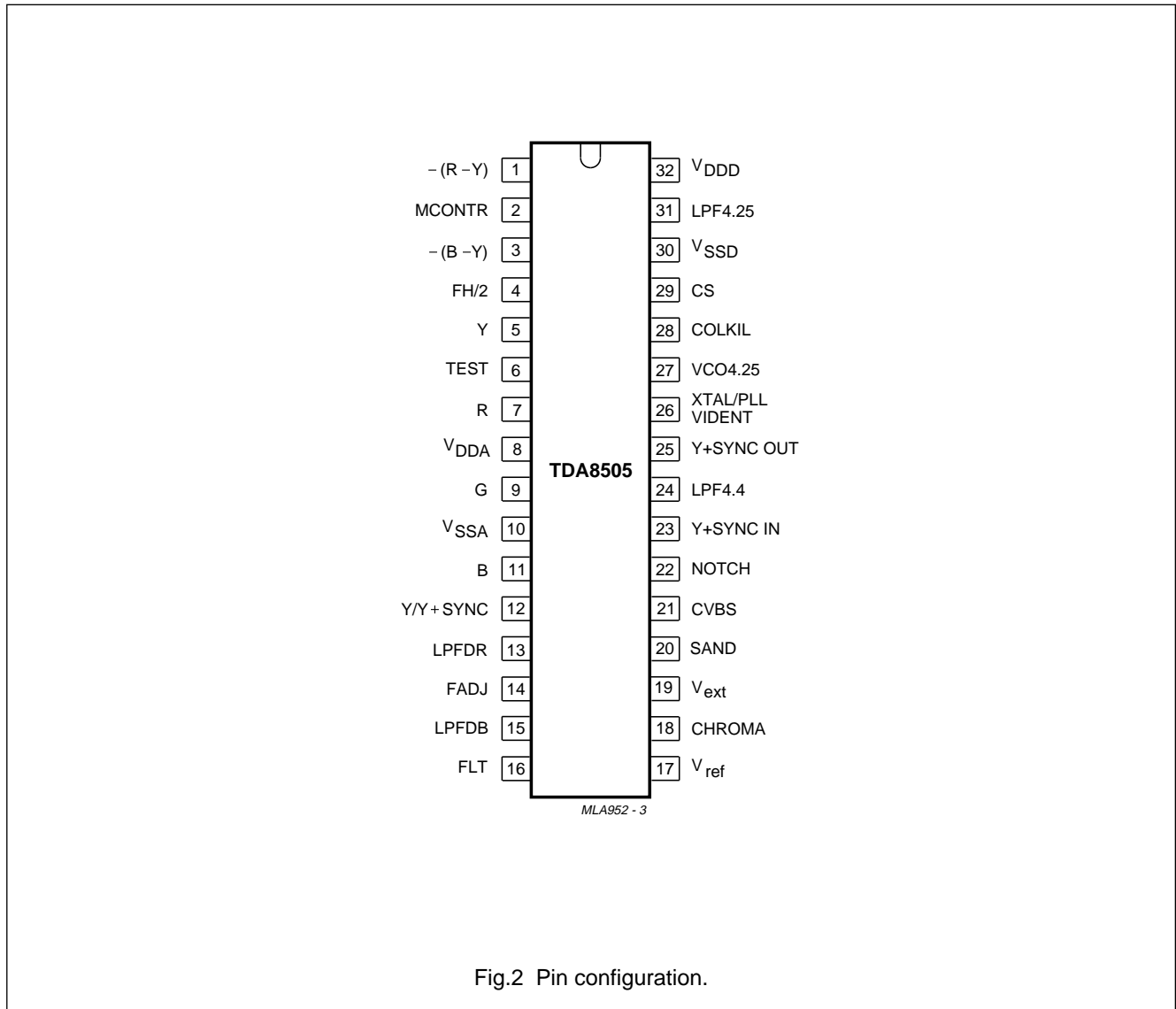

Fig.2 Pin configuration.

## SECAM encoder

## TDA8505

**FUNCTIONAL DESCRIPTION**

The following three important circuits are integrated:

- Encoder circuit
- Modulator control circuit
- Sync separator and pulse shaper.

**Encoder circuit****INPUT STAGE**

R, G and B inputs are connected to the matrix via a clamping and a blanking circuit.

For an EBU colour bar of 75% the amplitude of the signal must be 0.7 V (peak-to-peak value). The outputs of the matrix are Y, D'R and D'B.

The second part of the input stage contains inputs for colour difference signals and a luminance signal. The condition for 75% colour bar is  
 $-(R-Y) = 1.05$  V (peak-to-peak value) at pin 1,  
 $-(B-Y) = 1.33$  V (peak-to-peak value) at pin 3 and  
 $Y = 1$  V (peak-to-peak value) without sync at pin 5. After clamping and blanking the amplitude and polarity are corrected such that the signals are equal to the signals of the matrix output. Signals are connected to a switch. Fast switching between the two input parts is possible by the multiplexer control pin (pin 2).

The Y output signal of the multiplexer is added to the sync pulse of the sync separator.

The Y input (pin 5) is different to the other 5 inputs. The timing of the internal clamping is after the sync period and there is no vertical blanking.

The input blanking of Y can be switched off by a HIGH at pin 12, and the internal sync separator signal is not added to the Y signal. In this way the Y+SYNC is allowed at pin 5 and after clamping internally connected directly to pin 25.

The colour difference signals are switched sequentially by H/2 and fed to the low frequency pre-emphasis circuit.

The colour-killing input signal at pin 28 can be used for completely blanking the internal colour difference signals at the input of the low frequency pre-emphasis filter.

**LOW FREQUENCY PRE-EMPHASIS**

This filter is fully integrated, Fig.3 illustrates the nominal response.

The transfer is guaranteed within the illustrated area for the whole ambient temperature range by a compensation circuit.

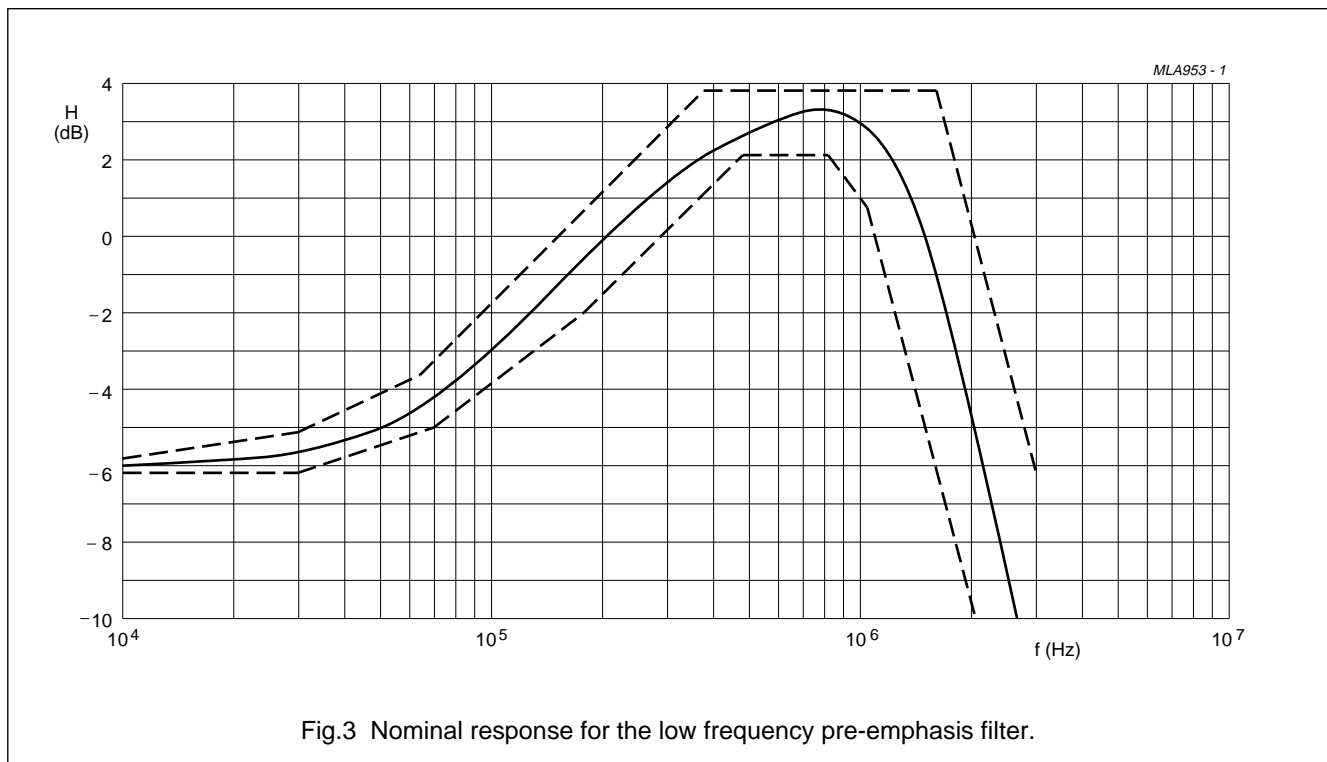

Fig.3 Nominal response for the low frequency pre-emphasis filter.

SECAM encoder

TDA8505

VERTICAL IDENTIFICATION

After the low frequency pre-emphasis the signal is clamped and, if desired the vertical identification sawtooth waveform can be added. The generation of the vertical identification is switched on/off by the logic level input at pin 26.

Figure 4 shows the sawtooth waveform at the input of the FM modulator with the corresponding frequency values after modulation.

**Vertical identification is only possible if PLL tuning is selected.**

GAIN + LIMITER

The gain of this amplifier is sequentially switched, so that the amplitude of D'R is 280/230 times the amplitude of D'B (based on an EBU colour bar). The signal is limited at a lower and upper level to ensure that the FM modulator frequencies are always between 3.9 MHz and 4.756 MHz. A DC offset between D'R and D'B is added which corresponds with the limiter levels.

FM MODULATOR

The signal of the gain + limiter stage is fed to the FM modulator.

The modulator control adjusts the DC level at pin 13 to set the frequency of the FM signal to 4.406 MHz at the black

level of D'R. The modulator control also sets the DC level at pin 15 to adjust the FM frequency to 4.250 MHz at the black level of D'B.

At the start of every line the FM modulator is stopped and is started again by a short duration pulse of the pulse shaper. These stop/start pulses are operating such that after two lines starting in the same phase, the start phase of the third line is shifted 180 degrees. This sequence is inverted during each vertical blanking.

The FM signal is fed to the internal HF pre-emphasis filter.

HF PRE-EMPHASIS AND BANDPASS FILTER

An HF pre-emphasis filter combined with a bandpass filter is integrated.

Figures 5 and 6 illustrate the frequency response. Two resistors in series with a potentiometer at pin 14 adjusts the frequency to 4.286 MHz with a tolerance of  $\pm 20$  kHz.

A tuning circuit integrated with an external capacitor connected to pin 16 guarantees a stable frequency response for the whole temperature range.

The output of the bandpass filter is connected directly to the chrominance blanking circuit.

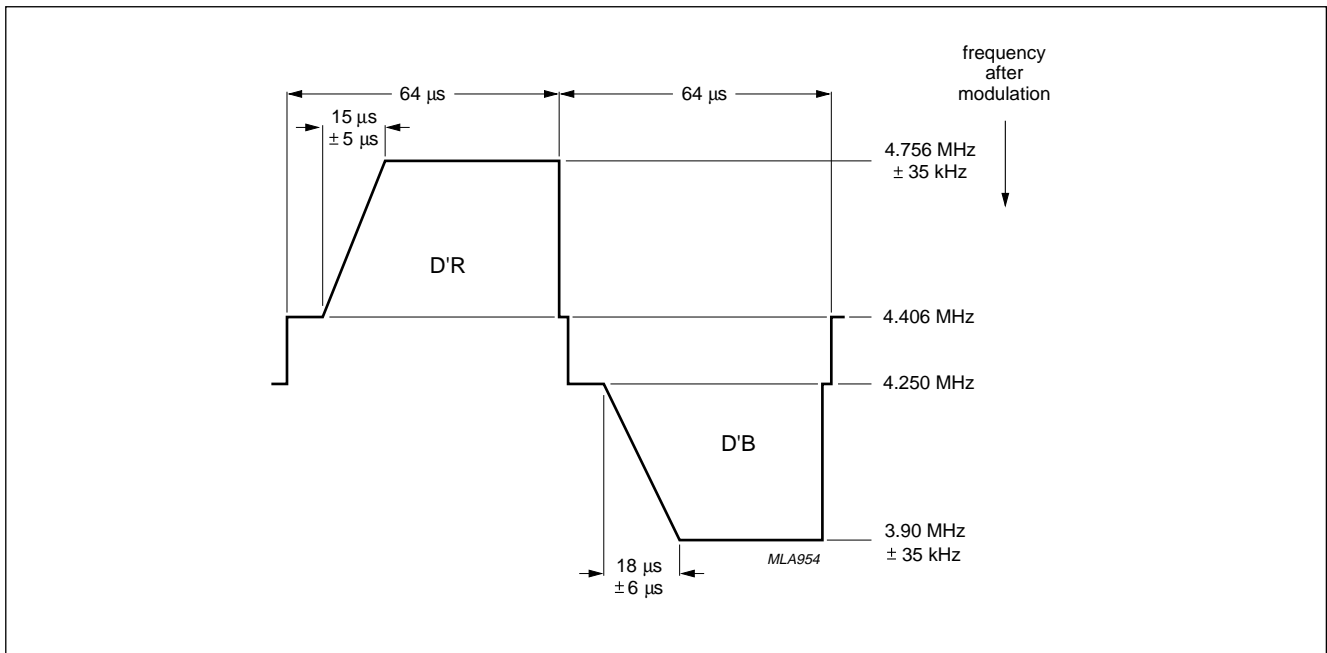

Fig.4 Vertical identification sawtooth waveform input.

SECAM encoder

TDA8505

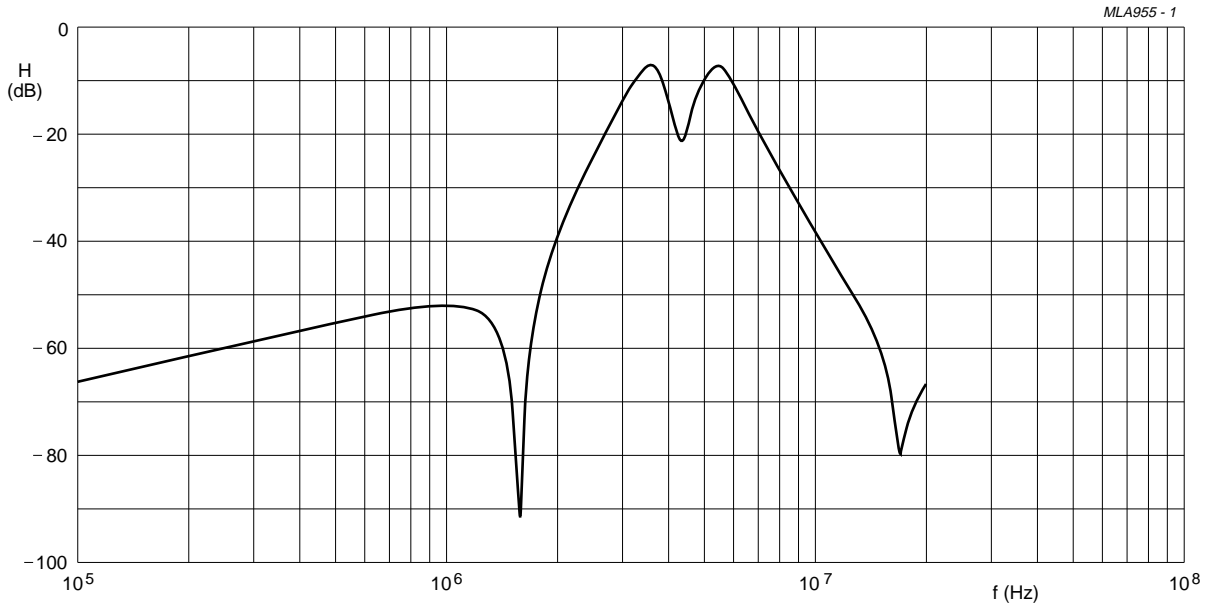

Fig.5 Frequency response of the HF pre-emphasis and bandpass filter; H as a function of frequency (1).

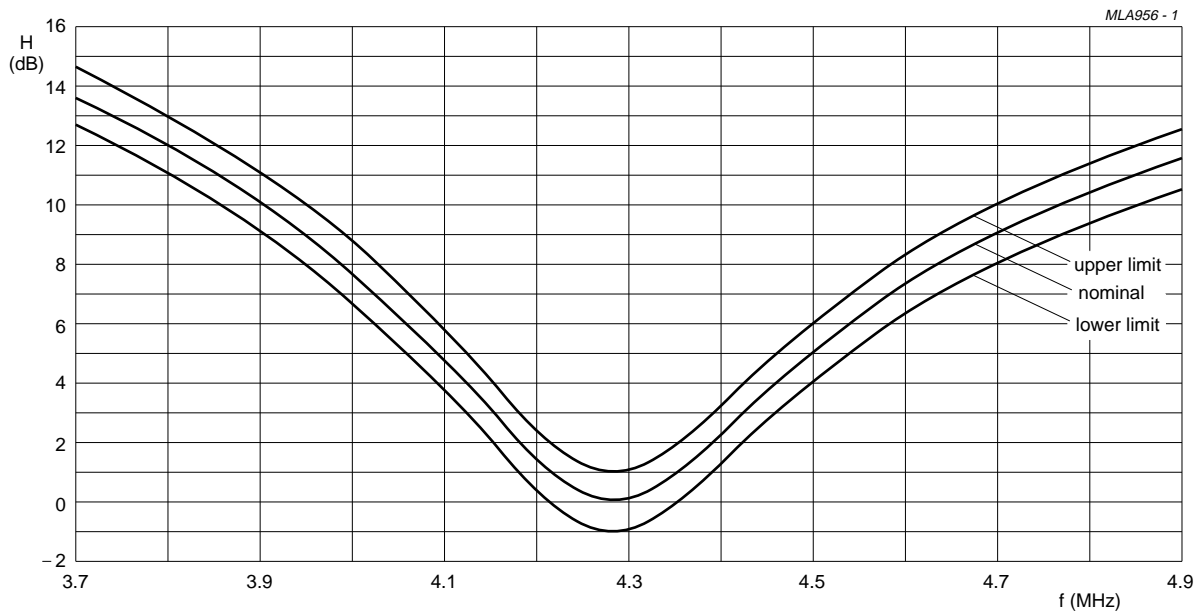

Fig.6 Frequency response of the HF pre-emphasis and bandpass filter; H as a function of frequency (2).



SECAM encoder

TDA8505

CHROMINANCE BLANKING

The chrominance signal is blanked by the internally generated chrominance blanking pulse. The output of this blanking stage is connected to the chrominance and CVBS output circuits.

Y+SYNC, CVBS, AND CHROMA OUTPUTS

The Y output signal of the matrix is added to the composite sync signal of the sync separator. The output of this adder at pin 25 is connected to the input of an external delay line which is necessary for correct timing of the Y+SYNC signal corresponding with the chrominance signal. The signal amplitude at pin 25 is 2 V (peak-to-peak value) nominal, so at the output of the delay line Y+SYNC is 1 V (peak-to-peak value).

**The delay line has to be DC-coupled between pins 25 and 23 to ensure the required DC level at pin 23. The output resistor of the delay line has to be connected to pin 17 where ( $V_{ref} = 2.5 V$ ).**

The output of the delay line is connected to pin 23 which is the input of a buffer operational amplifier. The output of the buffer operational amplifier is connected to pin 22 and to the CVBS adder stage via an internal resistor of 2 kΩ. An external notch filter can be connected to pin 22. The CVBS signal amplitude output at pin 21 is 2 V (peak-to-peak value) nominal. An external emitter follower is used to provide a 75 Ω output load.

The amplitude of the chrominance output signal which is connected to pin 18 corresponds with the Y+SYNC signal at the output of the delay line.

**Modulator control circuit**

The modulator control circuit has two tuning modes which are controlled by the input at pin 26:

- Tuning by line frequency
- Tuning by crystal or external signal source.

TUNING BY LINE FREQUENCY

Two reference voltage controlled oscillators (VCOs) are integrated, the 4.4 MHz VCO with an internal capacitor and the 4.25 MHz VCO with an external capacitor at pin 27.

A PLL loop with divider circuits directly couples the frequencies of the two VCOs with the line frequency of the sync separator sync signal.

The loop filter for the 4.40625 MHz reference is at pin 24 and the loop filter for the 4.250 MHz reference is at pin 31.

The outputs of the 272 divider are also used for pulse shaping.

Within the vertical blanking period, another two Phase Locked Loops (PLLs) synchronizes the FM modulator during two lines with the 4.406 MHz reference VCO and during the following 2 lines with the 4.250 MHz reference VCO. The loop filters are connected to pins 13 and 15 respectively.

**It is necessary to use low-leakage capacitors for these loop filters.**

TUNING BY CRYSTAL OR EXTERNAL SIGNAL SOURCE

When the frequency of the sync pulse at pin 29 is not stable or is incorrect it is possible to tune the FM modulator using an external 4.250 MHz crystal connected to pin 27. The 4.25 MHz loop at pin 31 has to be connected to pin 17 ( $V_{ref}$ ). A stable line frequency reference is generated by the 272 divider circuit which is used for the 4.406 MHz reference loop.

An external signal source, instead of a crystal, can be connected at pin 27 via a capacitor in series with a resistor.

The minimum AC current of 50 μA is determined by the resistor values ( $R_{int} + R_{ext}$ ) and the output voltage of the signal source (see Fig.7).

**When crystal tuning is used no vertical identification is possible.**

Crystal tuning is recommended for VTR signals.

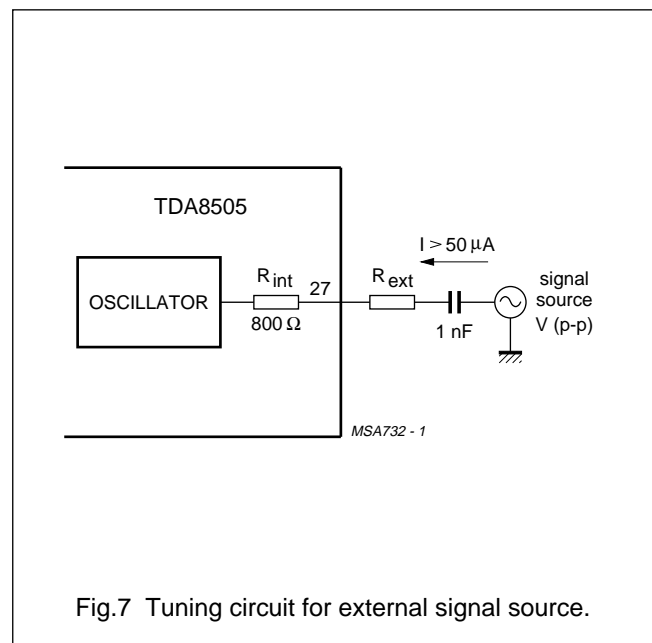

Fig.7 Tuning circuit for external signal source.

## SECAM encoder

## TDA8505

**Sync separator and pulse shaper**

The composite sync input at pin 29 together with the outputs of the 272 divider of the 4.250 MHz reference loop are the sources for all pulses necessary for the processing.

The pulses are used for:

- Clamping
- Video blanking
- FH/2
- Chrominance blanking
- Stop/start of modulator
- Vertical identification
- Timing for the modulator control
- Sandcastle pulse shaping at pin 20.

External FH/2 at pin 4 is only necessary when two or more SECAM encoders have to be locked in the same phase. The phase of the internal FH/2 can be locked with an external FH/2 connected at pin 4. A reset of the internal FH/2 is possible by forcing pin 4 to a HIGH level. This HIGH level corresponds with D'R. Pin 4 is connected to ground when not used.

Figures 9 and 10 show the generated pulses during vertical blanking for PLL tuning or crystal tuning respectively. Figure 11 shows the pulses during line blanking.

**Transcoding application**

A sandcastle pulse is necessary for the PAL/NTSC demodulator (i.e. TDA4510) for transcoding PAL or NTSC to SECAM.

Most of the demodulator ICs use a sandcastle pulse with an amplitude of 12 V or 8 V. A 12 V or 8 V sandcastle is not possible with the TDA8505 because of the 5 V power supply.

To generate a 3-level sandcastle pulse at pin 20 (see Fig.8) an external supply voltage must be connected to pin 19.

The PAL or NTSC CVBS signal is connected to the composite sync input (pin 29) for PLL tuning and pulse shaping. As previously mentioned the Y input at pin 5 can be used as the Y+SYNC input for the filtered Y+SYNC PAL or NTSC signal, when pin 12 is at a HIGH level.

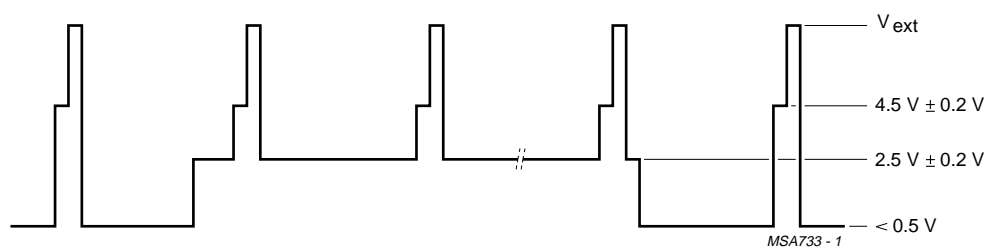
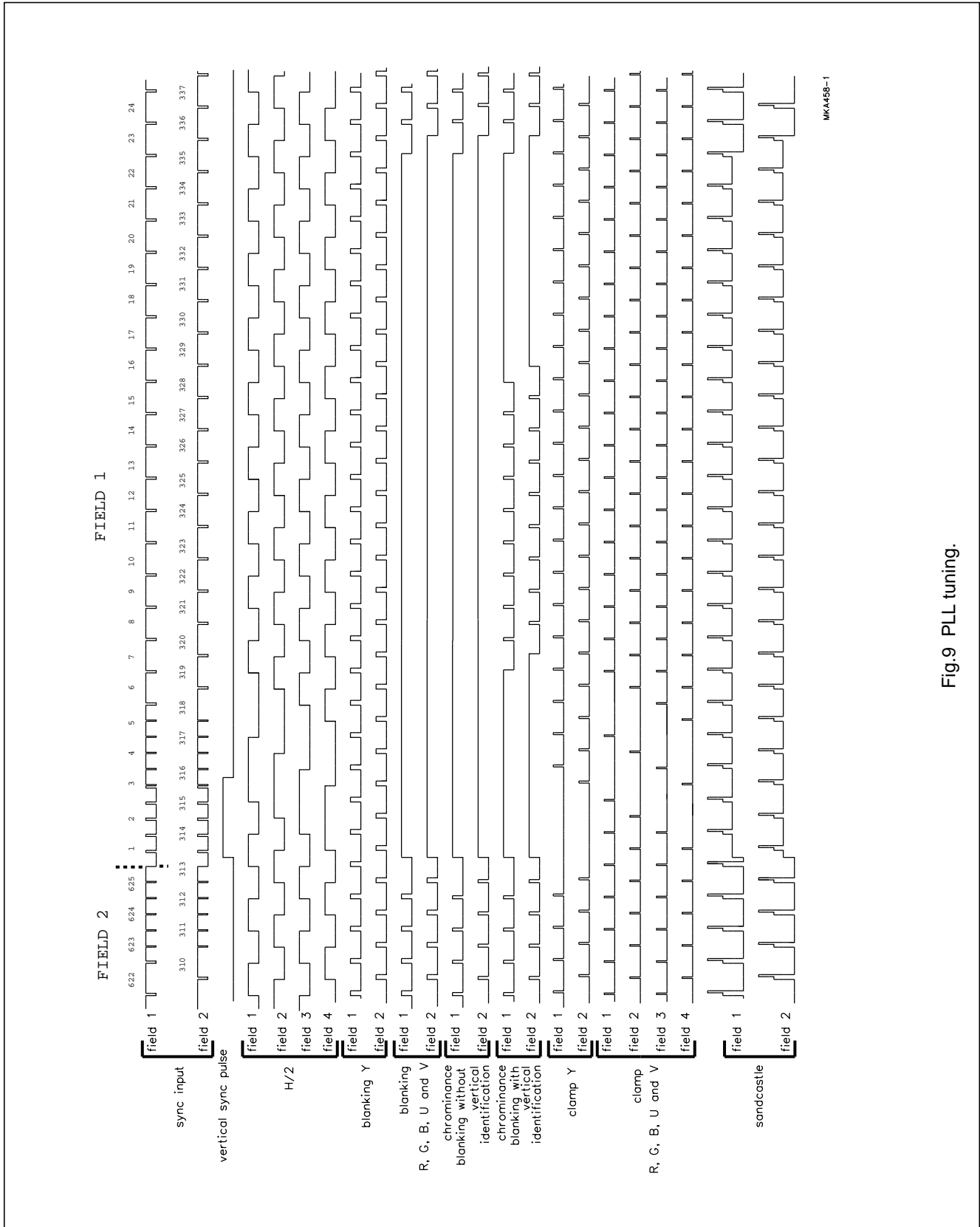

Fig.8 3-level sandcastle pulse.

SECAM encoder

TDA8505



MKA465-1

Fig.9 PLL tuning.

SECAM encoder

TDA8505

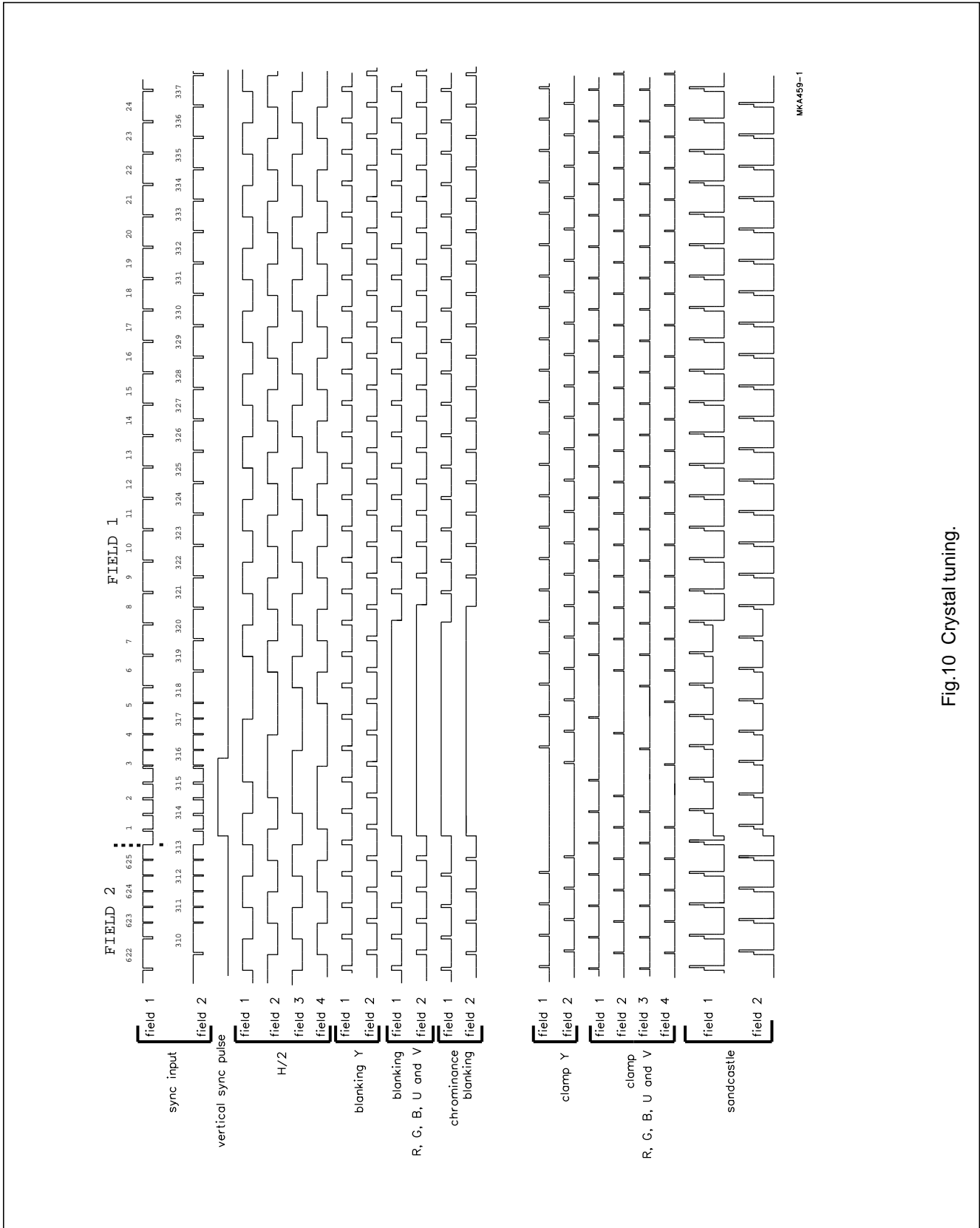
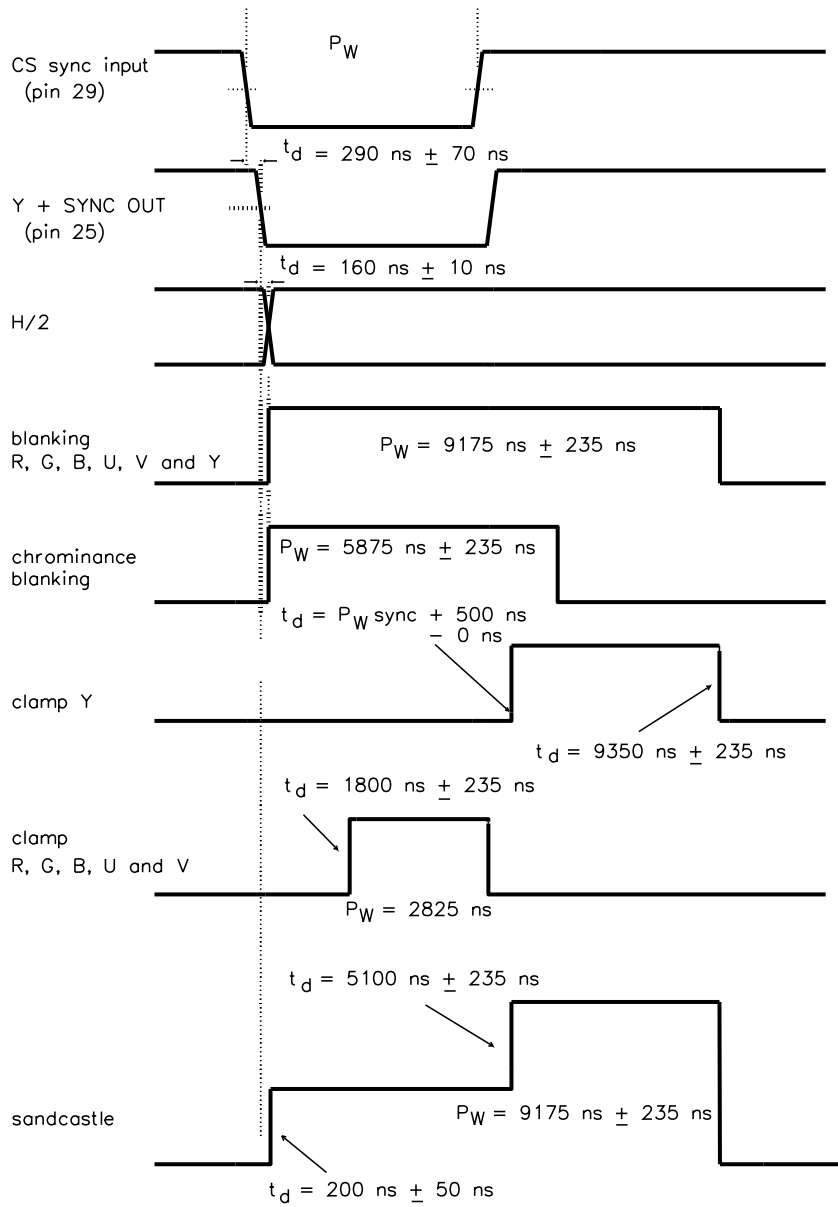

Fig.10 Crystal tuning.

SECAM encoder

TDA8505



MKA460-1

Fig.11 Pulses during line blanking.

## SECAM encoder

## TDA8505

**LIMITING VALUES**

In accordance with the Absolute Maximum Rating System (IEC 134); all voltages referenced to  $V_{SSA}$  pin 10.

SYMBOL	PARAMETER	MIN.	MAX.	UNIT
$V_{DDA}$	analog supply voltage for encoder part	0	5.5	V
$V_{DDD}$	digital supply voltage	0	5.5	V
$V_{ext}$	external supply voltage for sandcastle generation	0	13.2	V
$T_{stg}$	storage temperature	-65	+150	°C
$T_{amb}$	operating ambient temperature	-25	+70	°C

**THERMAL CHARACTERISTICS**

SYMBOL	PARAMETER	VALUE	UNIT
$R_{th\ j-a}$	thermal resistance from junction to ambient in free air	60	K/W

**DC CHARACTERISTICS**

$V_{CC}$  and  $V_{DD} = 5$  V;  $T_{amb} = 25$  °C; all voltages referenced to pins 10 and 30; unless otherwise specified.

SYMBOL	PARAMETER	MIN.	TYP.	MAX.	UNIT
$V_{DDA}$	analog supply voltage for encoder part (pin 8)	4.5	5.0	5.5	V
$V_{DDD}$	digital supply voltage (pin 32)	4.5	5.0	5.5	V
$I_{DDA}$	analog supply current	–	39	–	mA
$I_{DDD}$	digital supply current	–	4	–	mA
$V_{ext}$	external supply voltage for sandcastle generation	0	8 to 12	13.2	V
$P_{tot}$	total power dissipation	–	215	–	mW
$V_{ref}$	reference voltage output (pin 17)	2.425	2.5	2.575	V

**AC CHARACTERISTICS**

$V_{CC}$  and  $V_{DD} = 5$  V;  $T_{amb} = 25$  °C; composite sync signal connected to pin 29; unless otherwise specified.

SYMBOL	PARAMETER	CONDITIONS	MIN.	TYP.	MAX.	UNIT
<b>Encoder circuit: input stage (pins 1, 3, 5, 7, 9 and 11; black level = clamping level)</b>						
$V_{n(max)}$	voltage from black level positive		1.2	–	–	V
$V_{n(min)}$	voltage from black level negative	only pins 1, 3 and 5	0.9	–	–	V
$I_{bias(max)}$	maximum input bias current	$V_I = V_{17}$	–	–	1	μA
$V_I$	input voltage clamped	input capacitor connected to ground	–	$V_{17}$	–	V
$Z_I$	input clamping impedance	$I_I = 1$ mA	–	80	–	Ω
		$I_O = 1$ mA	–	80	–	Ω

## SECAM encoder

TDA8505

SYMBOL	PARAMETER	CONDITIONS	MIN.	TYP.	MAX.	UNIT
<b>Multiplexer control (pin 2; note 1)</b>						
V <sub>IL</sub>	LOW level input voltage Y, -(R-Y) and -(B-Y)		0	–	0.4	V
V <sub>IH</sub>	HIGH level input voltage R, G and B		1	–	5	V
I <sub>I</sub>	input current		–	–	–3	μA
t <sub>sw</sub>	switching time		–	50	–	ns
<b>Control input Y/Y+SYNC (pin 12)</b>						
V <sub>IL</sub>	LOW level input voltage	blanking pin 5 active; internal sync added to Y	0	–	1	V
V <sub>IH</sub>	HIGH level input voltage	blanking pin 5 inactive; internal sync not added to Y	4	–	5	V
I <sub>I(max)</sub>	maximum input current		–	–	1	μA
<b>XTAL/PLL and VIDENT input (pin 26)</b>						
V <sub>IL</sub>	LOW level input voltage	PLL mode; vertical identification off	0	–	1	V
V <sub>IH</sub>	HIGH level input voltage	crystal tuning; vertical identification off	4	–	5	V
V <sub>I</sub>	input voltage	pin 26 connected to pin 17; PLL tuning; vertical identification on; see Fig.4	–	V <sub>17</sub>	–	V
I <sub>I</sub>	input current		–	–	–6	μA
<b>COLKIL input (pin 28)</b>						
V <sub>IL</sub>	LOW level input voltage	inactive	0	–	1	V
V <sub>IH</sub>	HIGH level input voltage	active	4	–	5	V
I <sub>I(max)</sub>	maximum input current		–	–	1	μA
<b>FH/2 input (pin 4)</b>						
V <sub>IL</sub>	LOW level input voltage	inactive	0	–	1	V
V <sub>IH</sub>	HIGH level input voltage	active	4	–	5	V
I <sub>I(max)</sub>	maximum input current		–	–	1	μA
<b>LF pre-emphasis (see Fig.3)</b>						
<b>HF pre-emphasis and bandpass (see Figs 5 and 6)</b>						
<b>FADJ input (pin 14) resistor value for correct adjustment; see Fig.1</b>						
	input sensitivity		–	1.75	–	kHz/mV
I <sub>I(max)</sub>	maximum input current		–	–	100	nA

## SECAM encoder

## TDA8505

SYMBOL	PARAMETER	CONDITIONS	MIN.	TYP.	MAX.	UNIT
<b>FLT output (pin 16)</b>						
V <sub>DCL</sub>	limited DC LOW level output voltage	I <sub>O</sub> = 200 $\mu$ A	–	0.27	–	V
V <sub>DCH</sub>	limited DC HIGH level output voltage	I <sub>I</sub> = 200 $\mu$ A	–	1.8	–	V
V <sub>DC</sub>	DC level output voltage		tbf	0.86	tbf	V
<b>Y+SYNC output (pin 25)</b>						
R <sub>O</sub>	output resistance		–	–	40	$\Omega$
I <sub>sink(max)</sub>	maximum sink current		200	–	–	$\mu$ A
I <sub>source(max)</sub>	maximum source current		1	–	–	mA
V <sub>BL</sub>	black level output voltage		–	1.6	–	V
V <sub>SYNC</sub>	sync voltage amplitude		570	600	630	mV
V <sub>Y</sub>	Y voltage amplitude		1330	1400	1470	mV
B	bandwidth frequency response	R <sub>L</sub> = 10 k $\Omega$ ; C <sub>L</sub> = 10 pF	10	–	–	MHz
t <sub>d</sub>	group delay time tolerance	R <sub>L</sub> = 10 k $\Omega$ ; C <sub>L</sub> = 10 pF	–	–	20	ns
t <sub>d</sub>	sync delay time from pin 29 to pin 25		220	290	360	ns
t <sub>d</sub>	Y delay time from pin 5 to pin 25		–	10	–	ns
<b>Y+SYNC input (pin 23; note 2)</b>						
I <sub>bias</sub>	input bias current		–	–	1	$\mu$ A
V <sub>I(max)</sub>	maximum Y voltage amplitude		–	–	1	V
<b>NOTCH output (pin 22)</b>						
R <sub>O</sub>	output resistance		1750	2000	2250	$\Omega$
V <sub>DC</sub>	DC output voltage level		–	V <sub>23</sub>	–	V
I <sub>sink(max)</sub>	maximum sink current		300	–	–	$\mu$ A
<b>CHROMA output (pin 18)</b>						
I <sub>sink(max)</sub>	maximum sink current		200	–	–	$\mu$ A
I <sub>source(max)</sub>	maximum source current		1	–	–	mA
V <sub>DC</sub>	DC voltage level		–	2.5	–	V
$\Delta$ V <sub>DC</sub>	variation of DC voltage level	chrominance signal blanked	–	5	–	mV
		chrominance signal not blanked	–	5	–	mV
R <sub>O</sub>	output resistance		–	120	–	$\Omega$
V <sub>O(p-p)</sub>	chrominance output voltage amplitude (peak-to-peak value)	f = 4.25 MHz	–	165	–	mV
		f = 4.406 MHz	–	205	–	mV



## SECAM encoder

## TDA8505

SYMBOL	PARAMETER	CONDITIONS	MIN.	TYP.	MAX.	UNIT
FREQUENCY OF CHROMINANCE SIGNAL (NOTE 3)						
$f_{OR}$	black level of D'R		–	4406	–	kHz
$f_{OB}$	black level of D'B		–	4250	–	kHz
$f_{max}$	maximum frequency		4721	4756	4791	kHz
$f_{min}$	minimum frequency		3865	3900	3935	kHz
$\Delta D'R$	deviation of D'R	EBU bar of 75%	252	280	308	kHz
$\Delta D'B$	deviation of D'B	EBU bar of 75%	207	230	253	kHz
<b>CVBS output (pin 21)</b>						
$I_{sink(max)}$	maximum sink current		250	–	–	$\mu$ A
$I_{source(max)}$	maximum source current		1	–	–	mA
$V_{black}$	black level voltage		–	1.6	–	V
$G_Y$	gain Y+SYNC (pin 23 to pin 21)		–	6	–	dB
$G_{CHR}$	gain CHROMA (pin 18 to pin 21)		–	6	–	dB
$R_O$	output resistance		–	120	–	$\Omega$
<b>LPFDR output (pin 13)</b>						
$V_O$	DC control voltage level		tbf	2.4	tbf	V
	control sensitivity		–	0.2	–	kHz/mV
$I_{LO}$	output leakage current		–	–	50	nA
<b>LPFDB output (pin 15)</b>						
$V_O$	DC control voltage level		tbf	2.1	tbf	V
	control sensitivity		–	1.5	–	kHz/mV
$I_{LO}$	output leakage current		–	–	50	nA
<b>LPF4.4 output (pin 24)</b>						
$V_O$	DC control voltage level		tbf	2.3	tbf	V
	control sensitivity		–	1.5	–	kHz/mV
$I_{LO}$	output leakage current		–	–	100	nA
<b>LPF4.25 output (pin 31; <math>C_{ext} = 270</math> pF)</b>						
$V_O$	DC control voltage level		tbf	2.3	tbf	V
	control sensitivity		–	5.3	–	kHz/mV
$I_{LO}$	output leakage current		–	–	100	nA
<b>VCO4.25 (pin 27; note 4)</b>						
<b>CS input (pin 29)</b>						
$V_{I(p-p)}$	sync pulse input amplitude (peak-to-peak value)		75	300	600	mV
	slicing level		–	50	–	%
$I_I$	input current		–	4	–	$\mu$ A
$I_{O(max)}$	maximum output current	during sync	–	100	–	$\mu$ A

SECAM encoder

TDA8505

SYMBOL	PARAMETER	CONDITIONS	MIN.	TYP.	MAX.	UNIT
<b>V<sub>ext</sub> (pin 19)</b>						
I <sub>ext</sub>	external supply current		–	–	1.5	mA
<b>SAND output (pin 20; V<sub>ext</sub> = 13.2 V); see Fig.8</b>						
I <sub>sink(max)</sub>	maximum sink current		100	–	–	μA
I <sub>source(max)</sub>	maximum source current		100	–	–	μA
V <sub>TL</sub>	top voltage level	V <sub>ext</sub> < 10 V	V <sub>ext</sub> – 0.1	–	–	V
		V <sub>ext</sub> > 10 V	10	–	–	V

Notes

1. The threshold level of pin 2 is 700 ± 20 mV. The specification of the HIGH and LOW levels is in accordance with the scart fast blanking.
2. The black level of input signal must be 2 V; amplitude 1 V (peak-to-peak value) nominal (Y = 700 mV, SYNC = 300 mV).
3. The tolerances of f<sub>OR</sub> and f<sub>OB</sub> are with the printed-circuit board <±5 kHz. This value can be influenced by the print layout.
4. The oscillator operates in series-resonance. The resonance resistance of the crystal must be <60 Ω and parallel capacitance of the crystal <10 pF.

INTERNAL CIRCUITRY

PIN	NAME	CIRCUIT	DESCRIPTION
1	–(R–Y)		–(R–Y) input; connected via 47 nF capacitor; 1.05 V (peak-to-peak value) for EBU bar of 75%; see also pins 3, 5, 7, 9 and 11

SECAM encoder

TDA8505

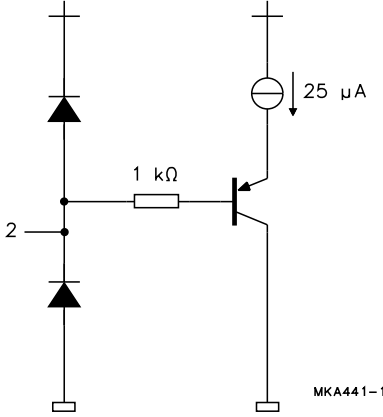
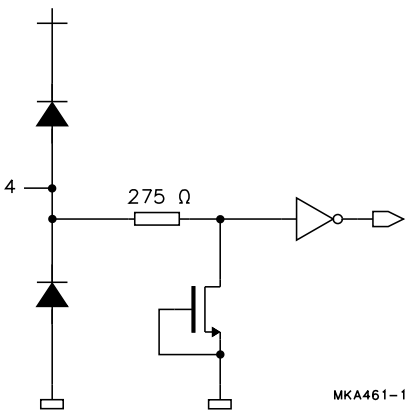
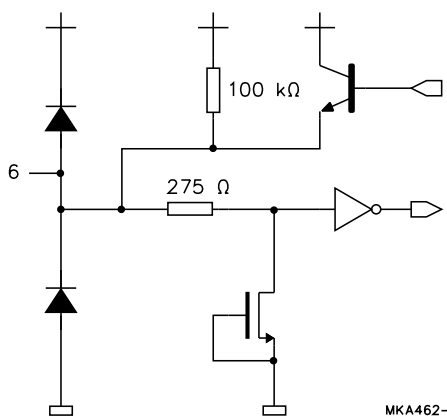
PIN	NAME	CIRCUIT	DESCRIPTION
2	MCONTR	 <p style="text-align: right;">MKA441-1</p>	multiplexer control input: <0.4 V Y, U and V >1 V R, G and B
3	-(B-Y)	see pin 1	-(B-Y) input; connected via 47 nF capacitor; 1.33 V (peak-to-peak value) for EBU bar of 75%
4	FH/2	 <p style="text-align: right;">MKA461-1</p>	FH/2 input; forcing possibility; when not used this pin is connected to ground
5	Y	see pin 1	Y input; connected via 47 nF capacitor; 1 V (peak-to-peak value) for EBU bar of 75%
6	TEST	 <p style="text-align: right;">MKA462-1</p>	test pin; connected to V <sub>CC</sub> or left open-circuit

SECAM encoder

TDA8505

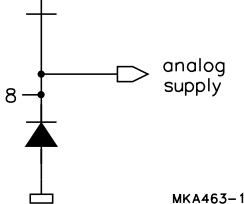
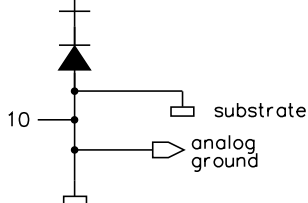
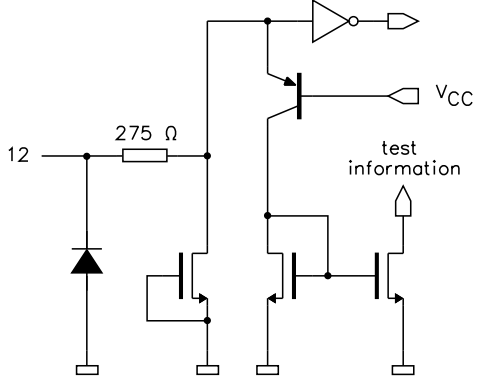
PIN	NAME	CIRCUIT	DESCRIPTION
7	R	see pin 1	RED input; connected via 47 nF capacitor; 0.7 V (peak-to-peak value) for EBU bar of 75%
8	V <sub>DDA</sub>		analog supply voltage for encoder part; 5 V nominal
9	G	see pin 1	GREEN input; connected via 47 nF capacitor; 0.7 V (peak-to-peak value) for EBU bar of 75%
10	V <sub>SSA</sub>		analog ground
11	B	see pin 1	BLUE input; connected via 47 nF capacitor; 0.7 V (peak-to-peak value) for EBU bar of 75%
12	Y/Y+SYNC		control pin: 0 V Y without sync supplied to pin 5 5 V Y with sync supplied to pin 5

SECAM encoder

TDA8505

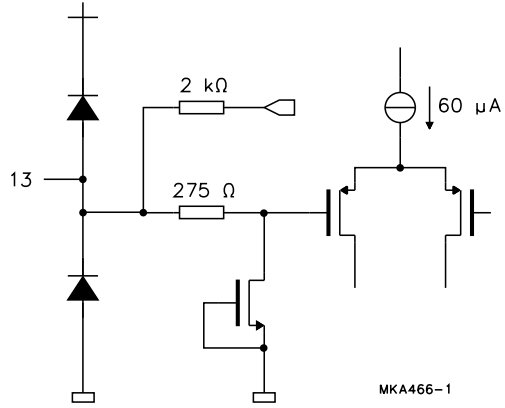
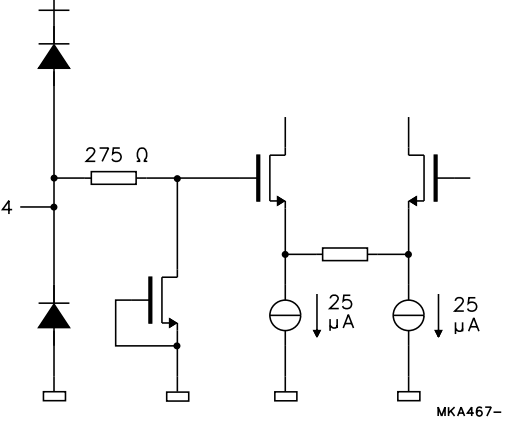
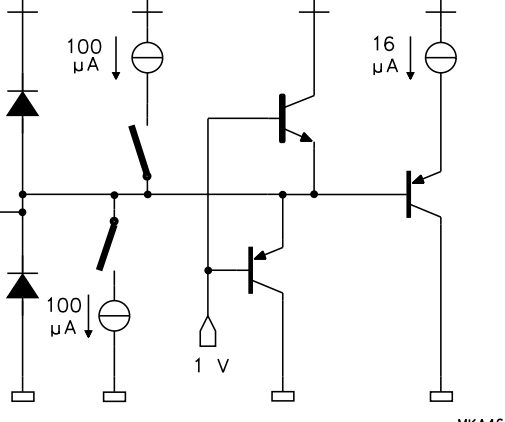
PIN	NAME	CIRCUIT	DESCRIPTION
13	LPFDR		modulator control loop filter with low leakage capacitors
14	FADJ		adjustment pin for 4.286 MHz: potentiometer in series with two resistors between ground and pin 17
15	LPFDB	see pin 13	modulator control loop filter with low leakage capacitors
16	FLT		filter control pin; 220 nF capacitor to ground

SECAM encoder

TDA8505

PIN	NAME	CIRCUIT	DESCRIPTION
17	$V_{ref}$		2.5 V reference voltage decoupling with 47 $\mu$ F and 22 nF capacitors
18	CHROMA		chrominance output
19	$V_{ext}$		pin for external power supply, for sandcastle pulse; $V_{ext} > 8$ V; if not used, the pin should be connected to ground
20	SAND		sandcastle pulse

SECAM encoder

TDA8505

PIN	NAME	CIRCUIT	DESCRIPTION
21	CVBS		composite SECAM output
22	NOTCH		pin for external notch filter
23	Y+SYNC IN		input of the delayed Y+SYNC signal of the delay line; black level must be 2 V
24	LPF4.4	see pin 13	loop filter for 4.40625 MHz reference oscillator

SECAM encoder

TDA8505

PIN	NAME	CIRCUIT	DESCRIPTION
25	Y+SYNC OUT	<p style="text-align: right;">MKA476-1</p>	<p>output of the delayed Y+SYNC signal, connected to the delay line via a resistor</p>
26	XTAL/PLL VIDENT	<p style="text-align: right;">MKA477-1</p>	<p>control pin:</p> <p><b>without</b> vertical identification:          0 V PLL tuning          5 V crystal tuning</p> <p><b>with</b> vertical identification:          2.5 V PLL tuning</p>
27	VCO4.25	<p style="text-align: right;">MKA478-1</p>	<p>tuning of 4.25 MHz oscillator:</p> <p>PLL tuning:          C = 270 pF to ground</p> <p>crystal tuning:          crystal in series with a capacitor to ground</p> <p>external tuning:          signal via 1 nF capacitor in series with a resistor</p>



SECAM encoder

TDA8505

PIN	NAME	CIRCUIT	DESCRIPTION
28	COLKIL		<p>colour killing input:                      0 V not active                      5 V active, internal D'R and D'B are blanked</p>
29	CS		<p>composite sync signal input;                      amplitude &lt;600 mV                      (peak-to-peak value)</p>
30	VSSD		<p>digital ground</p>

SECAM encoder

TDA8505

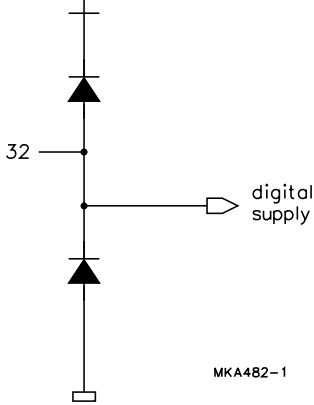
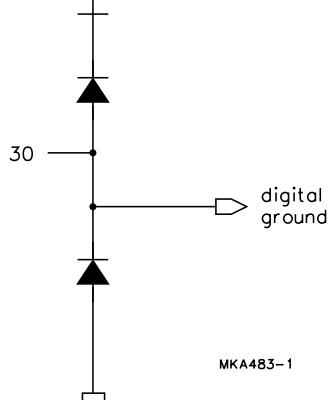
PIN	NAME	CIRCUIT	DESCRIPTION
31	LPF4.25		loop filter for 4.25 MHz reference oscillator; connected to pin 17 if crystal or external tuning
32	V <sub>DDD</sub>		supply voltage digital part; 5 V nominal

SECAM encoder

TDA8505

PACKAGE OUTLINE

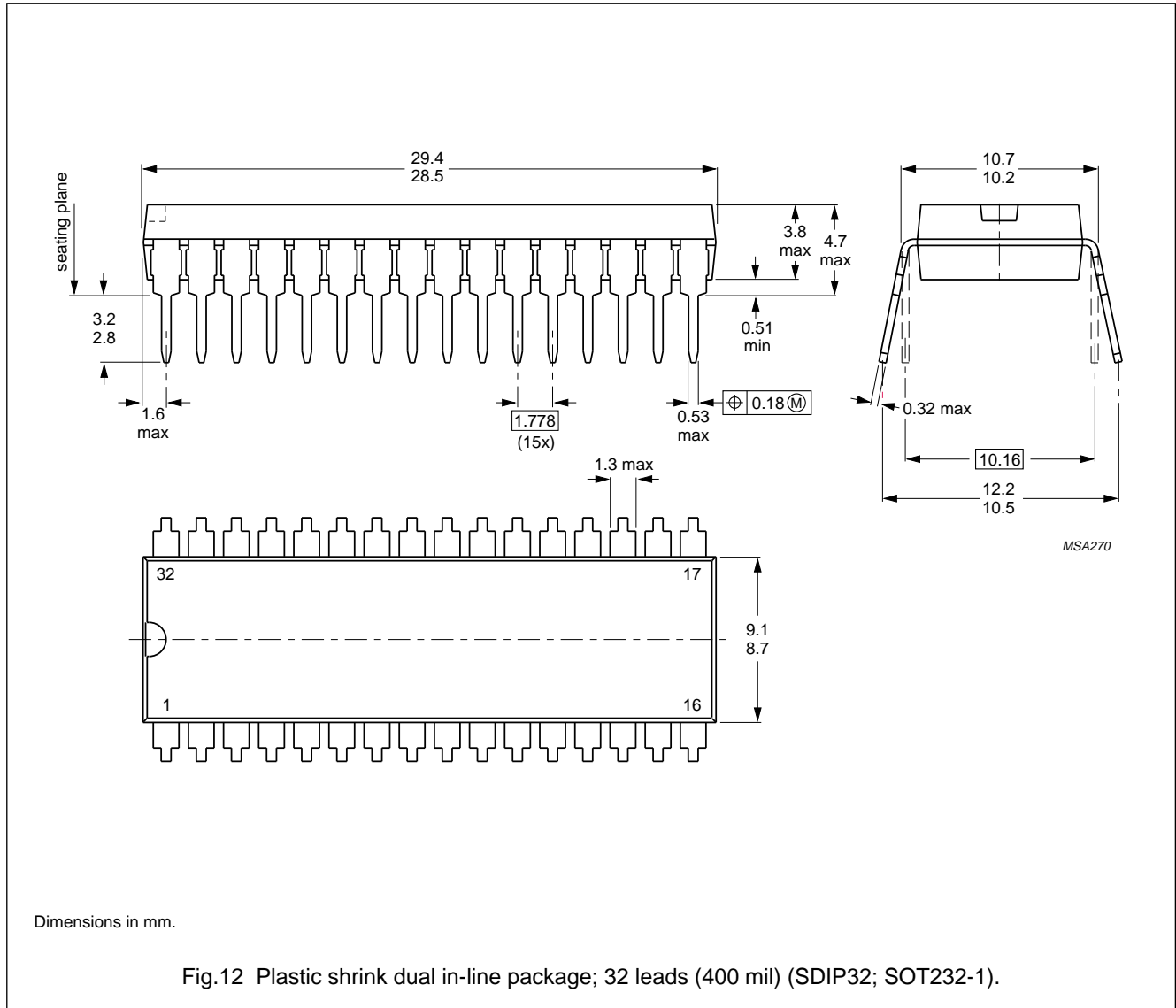

Dimensions in mm.

Fig.12 Plastic shrink dual in-line package; 32 leads (400 mil) (SDIP32; SOT232-1).

## SECAM encoder

## TDA8505

**SOLDERING****Plastic dual in-line packages**

BY DIP OR WAVE

The maximum permissible temperature of the solder is 260 °C; this temperature must not be in contact with the joint for more than 5 s. The total contact time of successive solder waves must not exceed 5 s.

The device may be mounted up to the seating plane, but the temperature of the plastic body must not exceed the

specified storage maximum. If the printed-circuit board has been pre-heated, forced cooling may be necessary immediately after soldering to keep the temperature within the permissible limit.

**REPAIRING SOLDERED JOINTS**

Apply a low voltage soldering iron below the seating plane (or not more than 2 mm above it). If its temperature is below 300 °C, it must not be in contact for more than 10 s; if between 300 and 400 °C, for not more than 5 s.

**DEFINITIONS**

<b>Data sheet status</b>	
Objective specification	This data sheet contains target or goal specifications for product development.
Preliminary specification	This data sheet contains preliminary data; supplementary data may be published later.
Product specification	This data sheet contains final product specifications.
<b>Limiting values</b>	
Limiting values given are in accordance with the Absolute Maximum Rating System (IEC 134). Stress above one or more of the limiting values may cause permanent damage to the device. These are stress ratings only and operation of the device at these or at any other conditions above those given in the Characteristics sections of the specification is not implied. Exposure to limiting values for extended periods may affect device reliability.	
<b>Application information</b>	
Where application information is given, it is advisory and does not form part of the specification.	

**LIFE SUPPORT APPLICATIONS**

These products are not designed for use in life support appliances, devices, or systems where malfunction of these products can reasonably be expected to result in personal injury. Philips customers using or selling these products for use in such applications do so at their own risk and agree to fully indemnify Philips for any damages resulting from such improper use or sale.

SECAM encoder

TDA8505

---

**NOTES**

SECAM encoder

TDA8505

---

**NOTES**

SECAM encoder

TDA8505

---

**NOTES**

## Philips Semiconductors – a worldwide company

**Argentina:** IEROD, Av. Juramento 1992 - 14.b, (1428)  
BUENOS AIRES, Tel. (541)786 7633, Fax. (541)786 9367

**Australia:** 34 Waterloo Road, NORTH RYDE, NSW 2113,  
Tel. (02)805 4455, Fax. (02)805 4466

**Austria:** Triester Str. 64, A-1101 WIEN, P.O. Box 213,  
Tel. (01)60 101-1236, Fax. (01)60 101-1211

**Belgium:** Postbus 90050, 5600 PB EINDHOVEN, The Netherlands,  
Tel. (31)40 783 749, Fax. (31)40 788 399

**Brazil:** Rua do Rocio 220 - 5<sup>th</sup> floor, Suite 51,  
CEP: 04552-903-SÃO PAULO-SP, Brazil.  
P.O. Box 7383 (01064-970).

Tel. (011)821-2333, Fax. (011)829-1849

**Canada:** INTEGRATED CIRCUITS:

Tel. (800)234-7381, Fax. (708)296-8556  
DISCRETE SEMICONDUCTORS: 601 Milner Ave,  
SCARBOROUGH, ONTARIO, M1B 1M8,  
Tel. (416)292 5161 ext. 2336, Fax. (416)292 4477

**Chile:** Av. Santa Maria 0760, SANTIAGO,  
Tel. (02)773 816, Fax. (02)777 6730

**Colombia:** IPRELENZO LTDA, Carrera 21 No. 56-17,  
77621 BOGOTA, Tel. (571)249 7624/(571)217 4609,  
Fax. (571)217 4549

**Denmark:** Prags Boulevard 80, PB 1919, DK-2300 COPENHAGEN S,  
Tel. (032)88 2636, Fax. (031)57 1949

**Finland:** Sinikalliontie 3, FIN-02630 ESPOO,  
Tel. (9)0-50261, Fax. (9)0-520971

**France:** 4 Rue du Port-aux-Vins, BP317,  
92156 SURESNES Cedex,  
Tel. (01)4099 6161, Fax. (01)4099 6427

**Germany:** PHILIPS COMPONENTS UB der Philips G.m.b.H.,  
P.O. Box 10 63 23, 20043 HAMBURG,  
Tel. (040)3296-0, Fax. (040)3296 213.

**Greece:** No. 15, 25th March Street, GR 17778 TAVROS,  
Tel. (01)4894 339/4894 911, Fax. (01)4814 240

**Hong Kong:** PHILIPS HONG KONG Ltd., Components Div.,  
6/F Philips Ind. Bldg., 24-28 Kung Yip St., KWAI CHUNG, N.T.,  
Tel. (852)424 5121, Fax. (852)428 6729

**India:** Philips INDIA Ltd, Components Dept,  
Shivsagar Estate, A Block,  
Dr. Annie Besant Rd. Worli, Bombay 400 018  
Tel. (022)4938 541, Fax. (022)4938 722

**Indonesia:** Philips House, Jalan H.R. Rasuna Said Kav. 3-4,  
P.O. Box 4252, JAKARTA 12950,  
Tel. (021)5201 122, Fax. (021)5205 189

**Ireland:** Newstead, Clonskeagh, DUBLIN 14,  
Tel. (01)640 000, Fax. (01)640 200

**Italy:** PHILIPS COMPONENTS S.r.l.,  
Viale F. Testi, 327, 20162 MILANO,  
Tel. (02)6752.3302, Fax. (02)6752 3300.

**Japan:** Philips Bldg 13-37, Kohnan2-chome, Minato-ku, TOKYO 108,  
Tel. (03)3740 5028, Fax. (03)3740 0580

**Korea:** (Republic of) Philips House, 260-199 Itaewon-dong,  
Yongsan-ku, SEOUL, Tel. (02)794-5011, Fax. (02)798-8022

**Malaysia:** No. 76 Jalan Universiti, 46200 PETALING JAYA,  
SELANGOR, Tel. (03)750 5214, Fax. (03)757 4880

**Mexico:** Philips Components, 5900 Gateway East, Suite 200,  
EL PASO, TX 79905, Tel. 9-5(800)234-7381, Fax. (708)296-8556

**Netherlands:** Postbus 90050, 5600 PB EINDHOVEN, Bldg. VB  
Tel. (040)783749, Fax. (040)788399

**New Zealand:** 2 Wagener Place, C.P.O. Box 1041, AUCKLAND,  
Tel. (09)849-4160, Fax. (09)849-7811

**Norway:** Box 1, Manglerud 0612, OSLO,  
Tel. (022)74 8000, Fax. (022)74 8341

**Pakistan:** Philips Electrical Industries of Pakistan Ltd.,  
Exchange Bldg. ST-2/A, Block 9, KDA Scheme 5, Clifton,  
KARACHI 75600, Tel. (021)587 4641-49,  
Fax. (021)577035/5874546.

**Philippines:** PHILIPS SEMICONDUCTORS PHILIPPINES Inc,  
106 Valero St. Salcedo Village, P.O. Box 2108 MCC, MAKATI,  
Metro MANILA, Tel. (02)810 0161, Fax. (02)817 3474

**Portugal:** PHILIPS PORTUGUESA, S.A.,  
Rua dr. António Loureiro Borges 5, Arquiparque - Miraflores,  
Apartado 300, 2795 LINDA-A-VELHA,  
Tel. (01)14163160/4163333, Fax. (01)14163174/4163366.

**Singapore:** Lorong 1, Toa Payoh, SINGAPORE 1231,  
Tel. (65)350 2000, Fax. (65)251 6500

**South Africa:** S.A. PHILIPS Pty Ltd., Components Division,  
195-215 Main Road Martindale, 2092 JOHANNESBURG,  
P.O. Box 7430 Johannesburg 2000,  
Tel. (011)470-5911, Fax. (011)470-5494.

**Spain:** Balmes 22, 08007 BARCELONA,  
Tel. (03)301 6312, Fax. (03)301 42 43

**Sweden:** Kottbygatan 7, Akalla. S-164 85 STOCKHOLM,  
Tel. (0)8-632 2000, Fax. (0)8-632 2745

**Switzerland:** Allmendstrasse 140, CH-8027 ZÜRICH,  
Tel. (01)488 2211, Fax. (01)481 77 30

**Taiwan:** PHILIPS TAIWAN Ltd., 23-30F, 66, Chung Hsiao West  
Road, Sec. 1. Taipei, Taiwan ROC, P.O. Box 22978,  
TAIPEI 100, Tel. (02)388 7666, Fax. (02)382 4382.

**Thailand:** PHILIPS ELECTRONICS (THAILAND) Ltd.,  
209/2 Sanpavuth-Bangna Road Prakanong,  
Bangkok 10260, THAILAND,  
Tel. (662)398-0141, Fax. (662)398-3319.

**Turkey:** Talatpasa Cad. No. 5, 80640 GÜLTEPE/ISTANBUL,  
Tel. (0212)279 2770, Fax. (0212)269 3094

**United Kingdom:** Philips Semiconductors Limited, P.O. Box 65,  
Philips House, Torrington Place, LONDON, WC1E 7HD,  
Tel. (071)436 41 44, Fax. (071)323 03 42

**United States:** INTEGRATED CIRCUITS:  
811 East Arques Avenue, SUNNYVALE, CA 94088-3409,  
Tel. (800)234-7381, Fax. (708)296-8556  
DISCRETE SEMICONDUCTORS: 2001 West Blue Heron Blvd.,  
P.O. Box 10330, RIVIERA BEACH, FLORIDA 33404,  
Tel. (800)447-3762 and (407)881-3200, Fax. (407)881-3300

**Uruguay:** Coronel Mora 433, MONTEVIDEO,  
Tel. (02)70-4044, Fax. (02)92 0601

**For all other countries apply to:** Philips Semiconductors,  
International Marketing and Sales, Building BAF-1,  
P.O. Box 218, 5600 MD, EINDHOVEN, The Netherlands,  
Telex 35000 phtcnl, Fax. +31-40-724825

SCD32

© Philips Electronics N.V. 1994

All rights are reserved. Reproduction in whole or in part is prohibited without the prior written consent of the copyright owner.

The information presented in this document does not form part of any quotation or contract, is believed to be accurate and reliable and may be changed without notice. No liability will be accepted by the publisher for any consequence of its use. Publication thereof does not convey nor imply any license under patent- or other industrial or intellectual property rights.

Printed in The Netherlands

533061/1500/03/pp32

Document order number:

Date of release: July 1994

9397 736 70011

# Philips Semiconductors



# PHILIPS