

NAIS

ULTRA-MINIATURE PC BOARD TYPE POWER RELAY

JS RELAYS

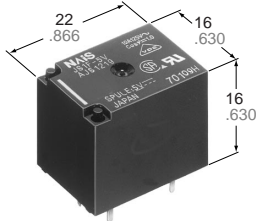

mm inch

FEATURES

- Ultra-miniature size with universal terminal footprint
- High contact capacity: 10 A
- Class B coil insulation type available
- TV-5 type available
 - 1 Form A type → TV-5
 - 1 Form C type → TV-5 (N.O. side only)
- VDE, TÜV also approved
- Sealed construction for automatic cleaning

SPECIFICATIONS

Contact		Characteristics	
Arrangement		1 Form A, 1 Form C	
Initial contact resistance, max. (By voltage drop 6 V DC 1 A)		100 mΩ	
Contact material		Silver alloy	
Rating (resistive load)	Nominal switching capacity	10 A 250 V AC 10 A 125 V AC 6 A 277 V AC	
	Max. switching power	2,500 VA	
	Max. switching voltage	250 V AC, 100 V DC	
	Max. switching current	10 A (AC), 5 A (DC)	
Expected life (min.ope.)	Mechanical (at 180 cpm)	10 ⁷	
	Electrical at 10 A 125 V AC, 6 A 277 V AC resistive (at 20 cpm)	10 ⁵	
	10 A 250 V AC resistive (at 20 cpm)	5 × 10 ⁴ (No contact only)	
Coil		Shock resistance	
Nominal operating power		360 mW	
Remarks		Functional* ³	
* Specifications will vary with foreign standards certification ratings.		Destructive* ⁴	
* ¹ Detection current: 10mA		Functional* ⁵	
* ² Excluding contact bounce time		Destructive	
* ³ Half-wave pulse of sine wave: 11ms; detection time: 10μs		Approx. 98 m/s ² {10 G}, 10 to 55 Hz at double amplitude of 1.6 mm	
* ⁴ Half-wave pulse of sine wave: 6ms		Approx. 117.6 m/s ² {12 G}, 10 to 55 Hz at double amplitude of 2 mm	
* ⁵ Detection time: 10μs		Conditions for operation, transport and storage* ⁶	
* ⁶ Refer to 5. Conditions for operation, transport and storage mentioned in AMBIENT ENVIRONMENT (Page 24).		Ambient temp.* ⁷	
* ⁷ When using relays in a high ambient temperature, consider the pick-up voltage rise due to the high temperature (a rise of approx. 0.4% V for each 1°C 33.8°F with 20°C 68°F as a reference) and use a coil impressed voltage that is within the maximum allowable voltage range.		Humidity	
		Unit weight	
		Approx. 12 g .423 oz	

TYPICAL APPLICATIONS

- Home appliances
Air conditioner, heater, etc.
- Automotive
Power-window, car antenna, door-lock,
etc.
- Office machines
PPC, facsimile, etc.
- Vending machines

ORDERING INFORMATION

Ex. JS 1a — F — B — 12V

Contact arrangement	Protective construction	Coil insulation class	Coil voltage (DC)
1: 1 Form C 1a: 1 Form A	Nil: Sealed type F: Flux-resistant type	Nil: Class E insulation B: Class B insulation	5, 6, 9, 12, 18, 24, 48 V

UL/CSA, VDE, TÜV approved type is standard.

Notes: 1. Standard packing: Carton: 100 pcs. Case: 500 pcs.

2. When ordering TV rated (TV-5) types, add suffix -TV.

COIL DATA

Part No.				Nominal voltage, V DC	Pick-up voltage, V DC (max.) (at 20°C/68°F)	Drop-out voltage, V DC (min.) (at 20°C/68°F)	Coil resistance, Ω ($\pm 10\%$) (at 20°C/68°F)	Nominal operating current, mA ($\pm 10\%$) (at 20°C/68°F)	Nominal operating power, mW (at 20°C/68°F)	Max. allowable voltage (at 85°C/185°F)
Sealed type		Flux-resistant type								
1 Form A	1 Form C	1 Form A	1 Form C							
JS1a-5V	JS1-5V	JS1aF-5V	JS1F-5V	5	3.5	0.5	69.4	72	360	130%V of nominal voltage
JS1a-6V	JS1-6V	JS1aF-6V	JS1F-6V	6	4.2	0.6	100	60		
JS1a-9V	JS1-9V	JS1aF-9V	JS1F-9V	9	6.3	0.9	225	40		
JS1a-12V	JS1-12V	JS1aF-12V	JS1F-12V	12	8.4	1.2	400	30		
JS1a-18V	JS1-18V	JS1aF-18V	JS1F-18V	18	12.6	1.8	900	20		
JS1a-24V	JS1-24V	JS1aF-24V	JS1F-24V	24	16.8	2.4	1,600	15		
JS1a-48V	JS1-48V	JS1aF-48V	JS1F-48V	48	33.6	4.8	6,400	7.5		

DIMENSIONS

mm inch

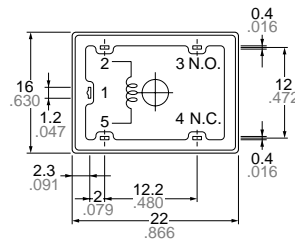
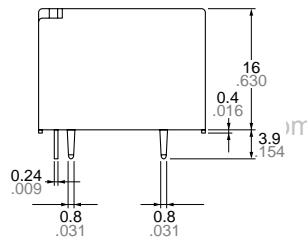

Note: Terminal No. 4 is only for 1 Form C type
General tolerance: $\pm 0.3 \pm 0.012$

Schematic (Bottom view)

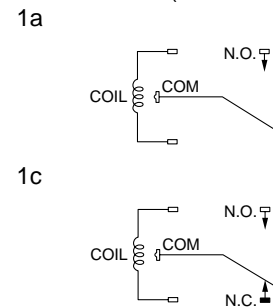

PC board pattern (Copper-side view)

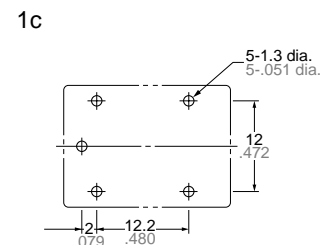
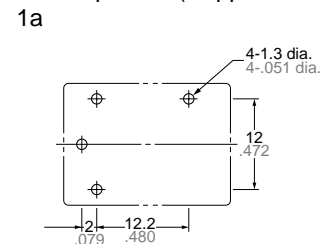

Tolerance: $\pm 0.1 \pm 0.004$

JS

REFERENCE DATA

1. Maximum value for switching capacity

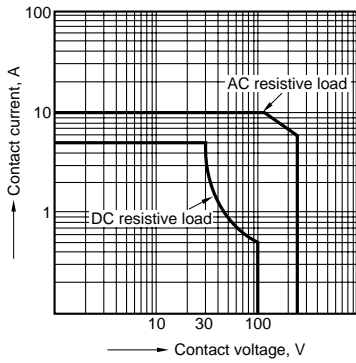

2. Operate/release time

Sample: 25 pcs., JS1-12V

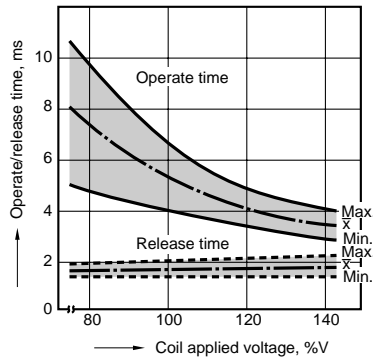

3. Life curve

Ambient temperature: Room temperature

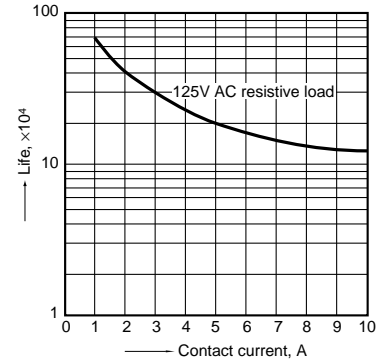

4-(1). Coil temperature rise

Sample: 5 pcs., JS1a-24V
Measured portion: Inside the coil
Contact current: 5 A

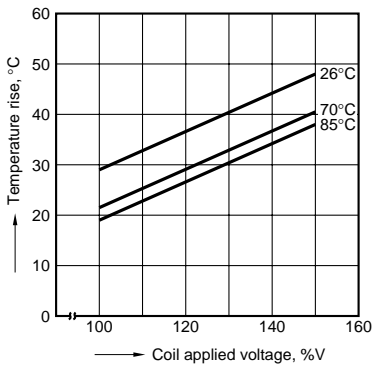

4-(2). Coil temperature rise

Sample: 5 pcs., JS1a-24V
Measured portion: Inside the coil
Contact current: 10 A

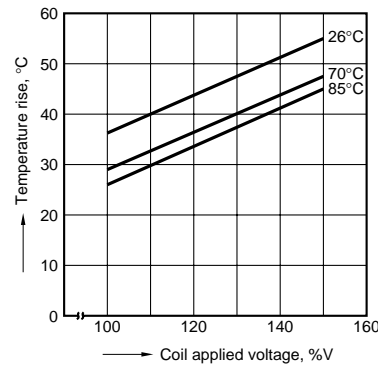

5. Ambient temperature characteristics

Sample: 6 pcs., JS1-12V

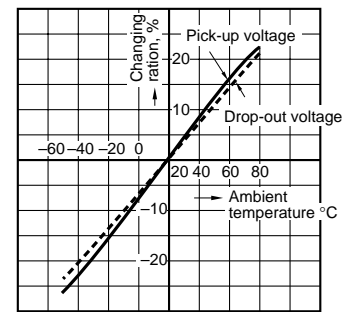

6. Electrical life test

(10 A 125 V AC, resistive load)

Sample: 6 pcs., JS1-12V
Operating speed: 20 cpm
Ambient temperature: room temperature

(Circuit)

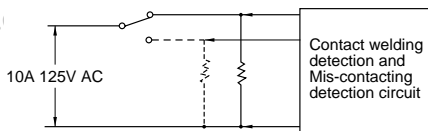

Change of pick-up and drop-out voltage

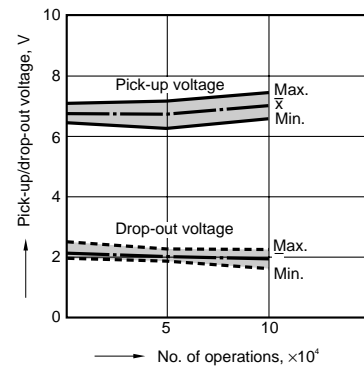

Change of contact resistance

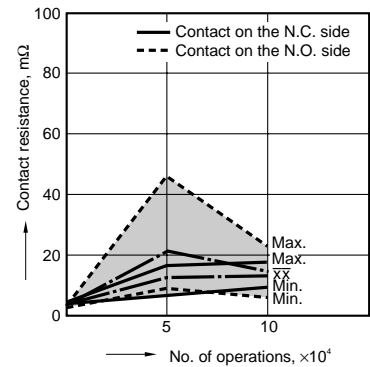

For Cautions for Use, see Relay Technical Information (Page 11 to 39).