

mm inch

FEATURES

- **Miniature size with universal terminal footprint**
- **High contact capacity: 10 A**
- **TV-5 type available (Standard type)**
1 Form A type → TV-5
1 Form C type → TV-5 (N.O. side only)
- **VDE, TÜV also approved**
- **Sealed construction for automatic cleaning (Standard type)**
- **Class B and F coil insulation type also available.**
- **EN60335-1 GWT compliant (Tested by VDE) type available**
- **Surge voltage 6 kV type also available**

About Cd-free contacts

We have introduced Cadmium free type products to reduce Environmental Hazardous Substances. (The suffix "F" should be added to the part number)
Please replace parts containing Cadmium with Cadmium-free products and evaluate them with your actual application before use because the life of a relay depends on the contact material and load.

www.DataSheet4U.com

SPECIFICATIONS

Contact

Types	Standard type	Long endurance type	
Arrangement	1 Form A, 1 Form C	1 Form A	
Initial contact resistance, max. (By voltage drop 6 V DC 1 A)	100 mΩ		
Contact material	AgSnO ₂ type		
Rating (resistive load)	Nominal switching capacity	10 A 250 V AC 10 A 125 V AC 6 A 277 V AC	10 A 250 V AC 10 A 125 V AC 10 A 277 V AC
	Max. switching power	2,500 VA	
	Max. switching voltage	250 V AC, 100 V DC	
	Max. switching current	10 A (AC), 5 A (DC)	
	Min. switching capacity ^{#1}	100 mA, 5 V DC	
Expected life (min. ope.)	Mechanical (at 180 cpm)	10 ⁷	
	Electrical at 10 A 125 V AC, 6 A 277 V AC resistive (standard) 10 A 277 V AC resistive (High power)	1×10 ⁵	2×10 ⁵
	10 A 250 V AC resistive (Standard: at 20 cpm) (High power: at 20 cpm, 105°C 221°F)**	5 × 10 ⁴ (No contact only)	1.2 × 10 ⁵

** Holding voltage should be 60% V of nominal voltage

Coil

Nominal operating power	360 mW
-------------------------	--------

^{#1} This value can change due to the switching frequency, environmental conditions, and desired reliability level, therefore it is recommended to check this with the actual load.

Remarks

- ^{*1} Detection current: 10mA
^{*2} Excluding contact bounce time

Characteristics

Max. operating speed	20 cpm	
Types	Standard type	Long endurance type
Initial insulation resistance	Min. 100 MΩ (at 500 V DC)	
Initial breakdown voltage ^{*1}	Between open contacts	750 Vrms for 1 min.
	Between contacts and coil	1,500 Vrms for 1 min.
Operate time ^{*2} (at nominal voltage)	Max. 10 ms	
Release time (without diode) ^{*2} (at nominal voltage)	Max. 10 ms	
Temperature rise (at nominal voltage)	Max. 35°C, resistive, nominal voltage applied to coil. Contact carrying current: 10A, at 70°C 158°F	
Shock resistance	Functional ^{*3}	98 m/s ² {10 G}
	Destructive ^{*4}	980 m/s ² {100 G}
Vibration resistance	Functional ^{*5}	10 to 55 Hz at double amplitude of 1.6 mm
	Destructive	10 to 55 Hz at double amplitude of 2 mm
Conditions for operation, transport and storage ^{*6} (Not freezing and condensing at low temperature)	Ambient temp. ^{*7}	-40°C to +85°C -40°F to +185°F
	Humidity	-40°C to +105°C -40°F to +221°F
Unit weight	5 to 85% R.H.	
	Approx. 12 g .423 oz	

^{*3} Half-wave pulse of sine wave: 11ms; detection time: 10μs

^{*4} Half-wave pulse of sine wave: 6ms

^{*5} Detection time: 10μs

^{*6} Refer to 6. Conditions for operation, transport and storage mentioned in [AMBIENT ENVIRONMENT \(p. 19, Relay Technical Information\)](#).

^{*7} When using relays in a high ambient temperature, consider the pick-up voltage rise due to the high temperature (a rise of approx. 0.4% V for each 1°C 33.8°F with 20°C 68°F as a reference) and use a coil impressed voltage that is within the maximum allowable voltage range.

TYPICAL APPLICATIONS

1. Home appliances
Air conditioner, heater, etc.
2. Automotive
Power-window, car antenna, door-lock, etc.
3. Office machines
PPC, facsimile, etc.
4. Vending machines

ORDERING INFORMATION

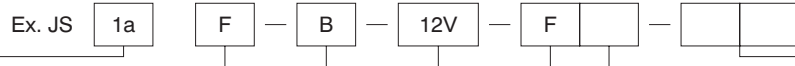

Contact arrangement	Protective construction	Coil insulation class	Coil voltage (DC)	Contact material	Flame resistance and tracking resistance	Surge voltage
1: 1 Form C (Standard) 1a: 1 Form A (Standard) 1aP: 1 Form A (Long endurance type)	Nil: Sealed type F: Flux-resistant type	Nil: Class E insulation B: Class B insulation F: Class F insulation	5, 6, 9, 12, 18, 24, 48 V	F: AgSnO ₂ type	Nil: — TT: EN60335-1 (Conform)	6K: 6kV type

Standard: UL/CSA, VDE, TÜV (Standard type)
UL/CSA, VDE (Long endurance type and EN60335-1 GWT compliant type)
UL/CSA (Surge voltage 6kV type)

- Notes: 1. Standard packing: Carton: 100 pcs. Case: 500 pcs.
2. When ordering TV rated (TV-5) types, add suffix -TV.
3. Contact arrangement 1aP type is Flux-resistant type only (Class B insulation only).

COIL DATA

Part No.					Nominal voltage, V DC	Pick-up voltage, V DC (max.) (at 20°C 68°F)	Drop-out voltage, V DC (min.) (at 20°C 68°F)	Coil resistance, Ω (±10%) (at 20°C 68°F)	Nominal operating current, mA (±10%) (at 20°C 68°F)	Nominal operating power, mW (at 20°C 68°F)	Max. allowable voltage (at 85°C 185°F)
Standard type				Long endurance type							
Sealed type		Flux-resistant type		Flux-resistant type							
1 Form A	1 Form C	1 Form A	1 Form C	1 Form A							
JS1a-5V-F	JS1-5V-F	JS1aF-5V-F	JS1F-5V-F	JS1aPF-B-5V-F	5	3.5	0.5	69.4	72	360	130%V of nominal voltage
JS1a-6V-F	JS1-6V-F	JS1aF-6V-F	JS1F-6V-F	JS1aPF-B-6V-F	6	4.2	0.6	100	60		
JS1a-9V-F	JS1-9V-F	JS1aF-9V-F	JS1F-9V-F	JS1aPF-B-9V-F	9	6.3	0.9	225	40		
JS1a-12V-F	JS1-12V-F	JS1aF-12V-F	JS1F-12V-F	JS1aPF-B-12V-F	12	8.4	1.2	400	30		
JS1a-18V-F	JS1-18V-F	JS1aF-18V-F	JS1F-18V-F	JS1aPF-B-18V-F	18	12.6	1.8	900	20		
JS1a-24V-F	JS1-24V-F	JS1aF-24V-F	JS1F-24V-F	JS1aPF-B-24V-F	24	16.8	2.4	1,600	15		
JS1a-48V-F	JS1-48V-F	JS1aF-48V-F	JS1F-48V-F	JS1aPF-B-48V-F	48	33.6	4.8	6,400	7.5		

- Notes) 1. Class B and F coil insulation types available.
Ex) JS1aF-B-12V-F
JS1aF-E-12V-F
2. Surge voltage 6kV types available. When ordering, please add suffix "6K" (except for Long endurance type and EN60335-1 GWT compliant type).
Ex) JS1aF-B-12V-F-6K

EN60335-1 GWT compliant types. When ordering, please add suffix "TT", e.g. JS1aF-B-12V-FTT

Part No.					Nominal voltage, V DC	Pick-up voltage, V DC (max.) (at 20°C 68°F)	Drop-out voltage, V DC (min.) (at 20°C 68°F)	Coil resistance, Ω (±10%) (at 20°C 68°F)	Nominal operating current, mA (±10%) (at 20°C 68°F)	Nominal operating power, mW (at 20°C 68°F)	Max. allowable voltage (at 85°C 185°F)
Standard type				Long endurance type							
Sealed type		Flux-resistant type		Flux-resistant type							
1 Form A	1 Form C	1 Form A	1 Form C	1 Form A							
JS1a-5V-FTT	JS1-5V-FTT	JS1aF-5V-FTT	JS1F-5V-FTT	JS1aPF-B-5V-FTT	5	3.5	0.5	69.4	72	360	130%V of nominal voltage
JS1a-6V-FTT	JS1-6V-FTT	JS1aF-6V-FTT	JS1F-6V-FTT	JS1aPF-B-6V-FTT	6	4.2	0.6	100	60		
JS1a-9V-FTT	JS1-9V-FTT	JS1aF-9V-FTT	JS1F-9V-FTT	JS1aPF-B-9V-FTT	9	6.3	0.9	225	40		
JS1a-12V-FTT	JS1-12V-FTT	JS1aF-12V-FTT	JS1F-12V-FTT	JS1aPF-B-12V-FTT	12	8.4	1.2	400	30		
JS1a-18V-FTT	JS1-18V-FTT	JS1aF-18V-FTT	JS1F-18V-FTT	JS1aPF-B-18V-FTT	18	12.6	1.8	900	20		
JS1a-24V-FTT	JS1-24V-FTT	JS1aF-24V-FTT	JS1F-24V-FTT	JS1aPF-B-24V-FTT	24	16.8	2.4	1,600	15		
JS1a-48V-FTT	JS1-48V-FTT	JS1aF-48V-FTT	JS1F-48V-FTT	JS1aPF-B-48V-FTT	48	33.6	4.8	6,400	7.5		

- Notes) 1. Class B and F coil insulation types available.
Ex) JS1aF-B-12V-FTT
JS1aF-E-12V-FTT
2. Surge voltage 6kV types are not available for the EN60335-1 GWT compliant type.

DIMENSIONS

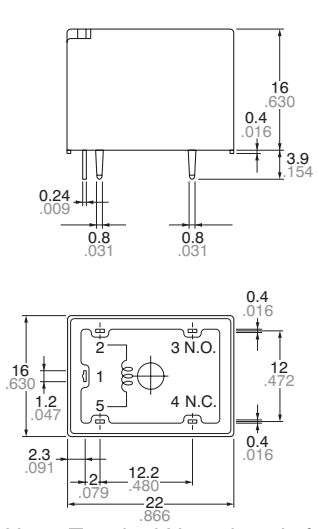

Note: Terminal No. 4 is only for Standard
 1 Form C type
 General tolerance: $\pm 0.3 \pm 0.12$

Schematic
 (Bottom view)

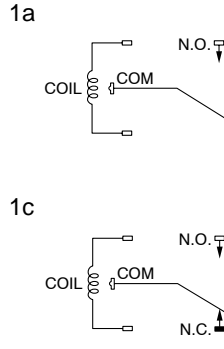

PC board pattern
 (Bottom view)

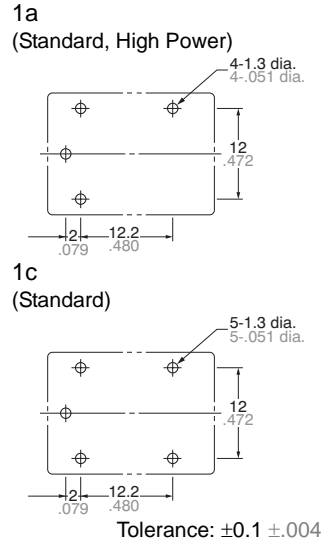

www.DataSheet4U.com

REFERENCE DATA

1. Maximum value for switching capacity

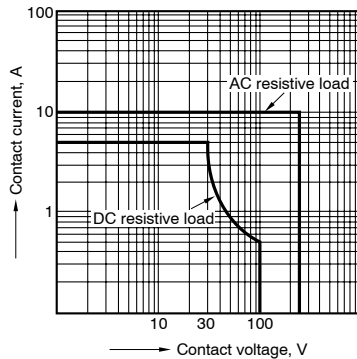

2. Operate/release time
 Sample: 25 pcs., JS1-12V-F

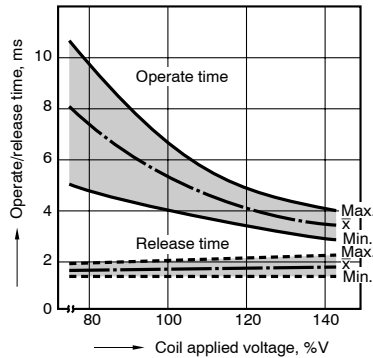

3. Life curve
 Ambient temperature: Room temperature

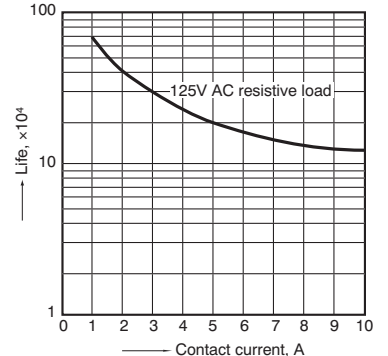

4-(1). Coil temperature rise
 Sample: 5 pcs., JS1a-24V-F
 Measured portion: Inside the coil
 Contact current: 5 A

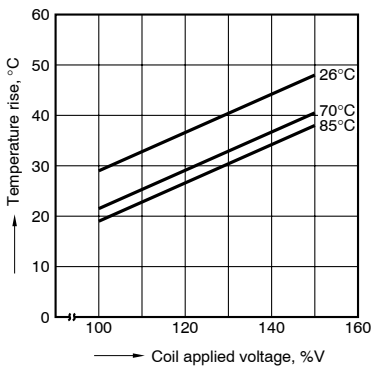

4-(2). Coil temperature rise
 Sample: 5 pcs., JS1a-24V-F
 Measured portion: Inside the coil
 Contact current: 10 A

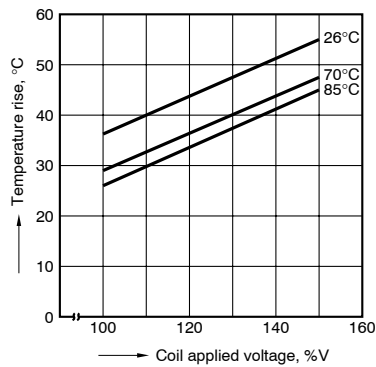

5. Ambient temperature characteristics
 Sample: 6 pcs., JS1-12V-F

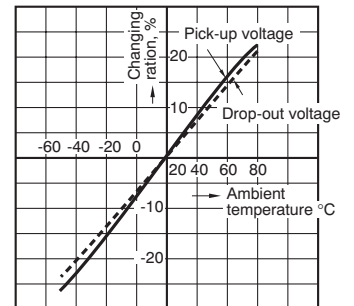

For Cautions for Use, see [Relay Technical Information](#).