

# GenX3™ 600V IGBT

High Speed PT IGBTs for  
40-100kHz switching

## IXGA30N60C3

## IXGP30N60C3

## IXGH30N60C3

$V_{CES} = 600V$

$I_{C110} = 30A$

$V_{CE(sat)} \leq 3.0V$

$t_{fi(typ)} = 47ns$

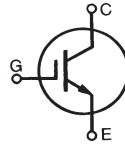

Symbol	Test Conditions	Maximum Ratings	
$V_{CES}$	$T_C = 25^\circ C$ to $150^\circ C$	600	V
$V_{CGR}$	$T_J = 25^\circ C$ to $150^\circ C$ , $R_{GE} = 1M\Omega$	600	V
$V_{GES}$	Continuous	$\pm 20$	V
$V_{GEM}$	Transient	$\pm 30$	V
$I_{C25}$	$T_C = 25^\circ C$	60	A
$I_{C110}$	$T_C = 110^\circ C$	30	A
$I_{CM}$	$T_C = 25^\circ C$ , 1ms	150	A
<b>SSOA</b> <b>(RBSOA)</b>	$V_{GE} = 15V$ , $T_{VJ} = 125^\circ C$ , $R_G = 5\Omega$ Clamped inductive load @ $\leq 600V$	$I_{CM} = 60$	A
$P_C$	$T_C = 25^\circ C$	220	W
$T_J$		-55 ... +150	$^\circ C$
$T_{JM}$		150	$^\circ C$
$T_{stg}$		-55 ... +150	$^\circ C$
$T_L$	1.6mm (0.062 in.) from case for 10s	300	$^\circ C$
$T_{SOLD}$	Plastic body for 10 seconds	260	$^\circ C$
$M_d$	Mounting torque (TO-220 & TO-247)	1.13/10	Nm/lb.in.
<b>Weight</b>	TO-220	2.5	g
	TO-263	3.0	g
	TO-263	3.0	g

TO-263 (IXGA)

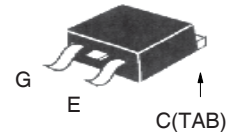

TO-220 (IXGP)

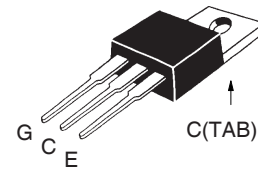

TO-247 (IXGH)

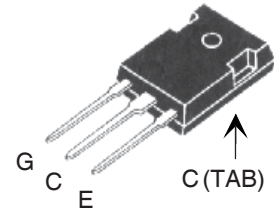

G = Gate      C = Collector  
E = Emitter    TAB = Collector

### Features

- Optimized for low switching losses
- Square RBSOA
- International standard packages

### Advantages

- High power density
- Low gate drive requirement

### Applications

- High Frequency Power Inverters
- UPS
- Motor Drives
- SMPS
- PFC Circuits
- Battery Chargers
- Welding Machines
- Lamp Ballasts

Symbol	Test Conditions ( $T_J = 25^\circ C$ unless otherwise specified)	Characteristic Values		
		Min.	Typ.	Max.
$BV_{CES}$	$I_C = 250\mu A$ , $V_{GE} = 0V$	600		V
$V_{GE(th)}$	$I_C = 250\mu A$ , $V_{CE} = V_{GE}$	3.5		5.5 V
$I_{CES}$	$V_{CE} = V_{CES}$ $V_{GE} = 0V$ $T_J = 125^\circ C$			15 $\mu A$
				300 $\mu A$
$I_{GES}$	$V_{CE} = 0V$ , $V_{GE} = \pm 20V$			$\pm 100$ nA
$V_{CE(sat)}$	$I_C = 20A$ , $V_{GE} = 15V$ , Note 1 $T_J = 125^\circ C$	2.6		3.0 V
		1.8		V

Symbol	Test Conditions ( $T_J = 25^\circ\text{C}$ unless otherwise specified)	Characteristic Values		
		Min.	Typ.	Max.
$g_{fs}$	$I_C = 20\text{A}, V_{CE} = 10\text{V}$ , Note 1	9	16	S
$C_{ies}$	$V_{CE} = 25\text{V}, V_{GE} = 0\text{V}, f = 1\text{MHz}$		915	pF
$C_{oes}$			78	pF
$C_{res}$			32	pF
$Q_g$	$I_C = 20\text{A}, V_{GE} = 15\text{V}, V_{CE} = 0.5 \cdot V_{CES}$		38	nC
$Q_{ge}$			8	nC
$Q_{gc}$			17	nC
$t_{d(on)}$	<b>Inductive Load, <math>T_J = 25^\circ\text{C}</math></b> $I_C = 20\text{A}, V_{GE} = 15\text{V}$ $V_{CE} = 300\text{V}, R_G = 5\Omega$		16	ns
$t_{ri}$			26	ns
$E_{on}$			0.27	mJ
$t_{d(off)}$			42	75 ns
$t_{fi}$			47	ns
$E_{off}$			0.09	0.18 mJ
$t_{d(on)}$	<b>Inductive Load, <math>T_J = 125^\circ\text{C}</math></b> $I_C = 20\text{A}, V_{GE} = 15\text{V}$ $V_{CE} = 300\text{V}, R_G = 5\Omega$		17	ns
$t_{ri}$			28	ns
$E_{on}$			0.44	mJ
$t_{d(off)}$			70	ns
$t_{fi}$			90	ns
$E_{off}$			0.33	mJ
$R_{thJC}$			0.56	$^\circ\text{C/W}$
$R_{thCS}$	TO-220	0.50		$^\circ\text{C/W}$
	TO-247	0.21		$^\circ\text{C/W}$

Note 1: Pulse test,  $t \leq 300\mu\text{s}$ ; duty cycle,  $d \leq 2\%$ .

### TO-220 (IXGP) Outline

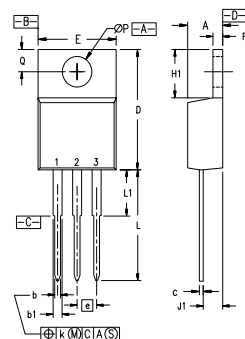

Pins: 1 - Gate 2 - Drain  
3 - Source 4 - Drain

SYM	INCHES		MILLIMETERS	
	MIN	MAX	MIN	MAX
A	.170	.190	4.32	4.83
b	.025	.040	0.64	1.02
b1	.045	.065	1.15	1.65
c	.014	.022	0.35	0.56
D	.580	.630	14.73	16.00
E	.390	.420	9.91	10.66
e	.100 BSC		2.54 BSC	
F	.045	.055	1.14	1.40
H1	.230	.270	5.85	6.85
J1	.090	.110	2.29	2.79
k	0	.015	0	0.38
L	.500	.550	12.70	13.97
L1	.110	.230	2.79	5.84
$\varnothing P$	.139	.161	3.53	4.08
Q	.100	.125	2.54	3.18

### TO-247 (IXGH) AD Outline

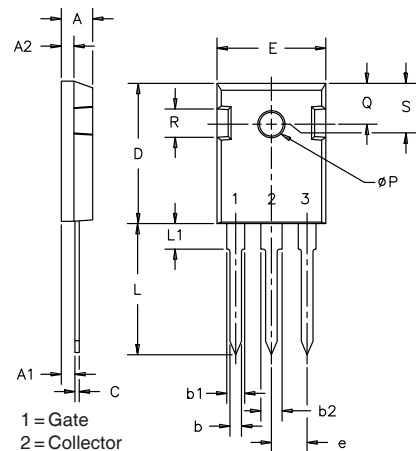

1 = Gate  
2 = Collector  
3 = Emitter  
Tab = Collector

SYM	INCHES		MILLIMETERS	
	MIN	MAX	MIN	MAX
A	.185	.209	4.7	5.3
A1	.087	.102	2.2	2.54
A2	.059	.098	2.2	2.6
b	.040	.055	1.0	1.4
b1	.065	.084	1.65	2.13
b2	.113	.123	2.87	3.12
C	.016	.031	.4	.8
D	.819	.845	20.80	21.46
E	.610	.640	15.75	16.26
e	.215 BSC		5.45 BSC	
L	.780	.800	19.81	20.32
L1		.177		4.50
$\varnothing P$	.140	.144	3.55	3.65
Q	.212	.244	5.4	6.2
R	.170	.216	4.32	5.49
S	.242 BSC		6.15 BSC	

### TO-263 (IXGA) Outline

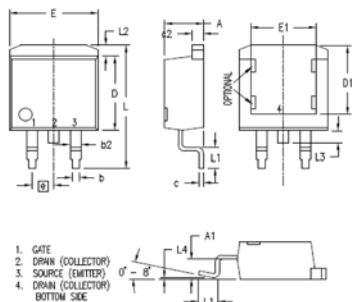

SYM	INCHES		MILLIMETERS	
	MIN	MAX	MIN	MAX
A	.160	.190	4.06	4.83
A1	.080	.110	2.03	2.79
b	.020	.039	0.51	0.99
b2	.045	.055	1.14	1.40
c	.016	.029	0.40	0.74
c2	.045	.055	1.14	1.40
D	.340	.380	8.64	9.65
D1	.315	.350	8.00	8.89
E	.380	.410	9.65	10.41
E1	.245	.320	6.22	8.13
e	.100 BSC		2.54 BSC	
L	.575	.625	14.61	15.88
L1	.090	.110	2.29	2.79
L2	.040	.055	1.02	1.40
L3	.050	.070	1.27	1.78
L4	0	.005	0	0.13

IXYS reserves the right to change limits, test conditions and dimensions.

IXYS MOSFETs and IGBTs are covered 4,835,592 4,931,844 5,049,961 5,237,481 6,162,665 6,404,065 B1 6,683,344 6,727,585 7,005,734 B2 7,157,338 B2  
by one or more of the following U.S. patents: 4,850,072 5,017,508 5,063,307 5,381,025 6,259,123 B1 6,534,343 6,710,405 B2 6,759,692 7,063,975 B2  
4,881,106 5,034,796 5,187,117 5,486,715 6,306,728 B1 6,583,505 6,710,463 6,771,478 B2 7,071,537

**Fig. 1. Output Characteristics @ 25°C**

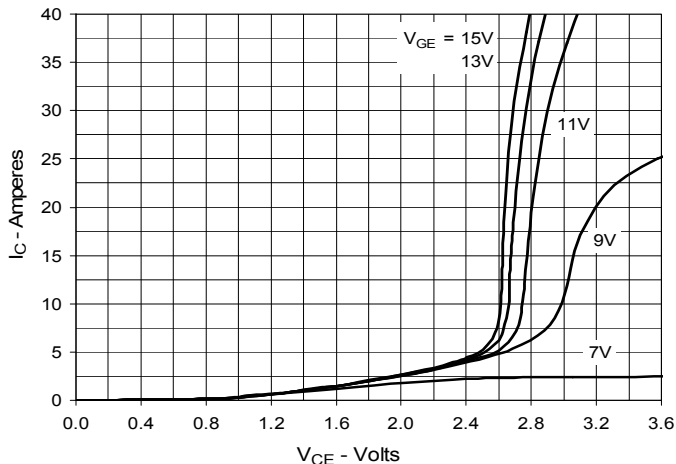

**Fig. 2. Extended Output Characteristics @ 25°C**

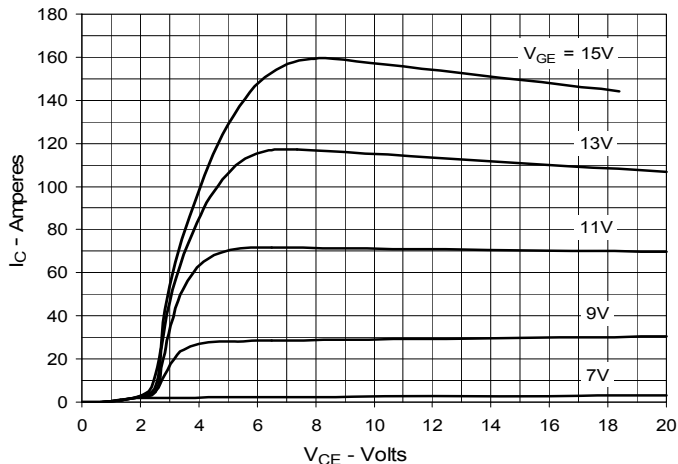

**Fig. 3. Output Characteristics @ 125°C**

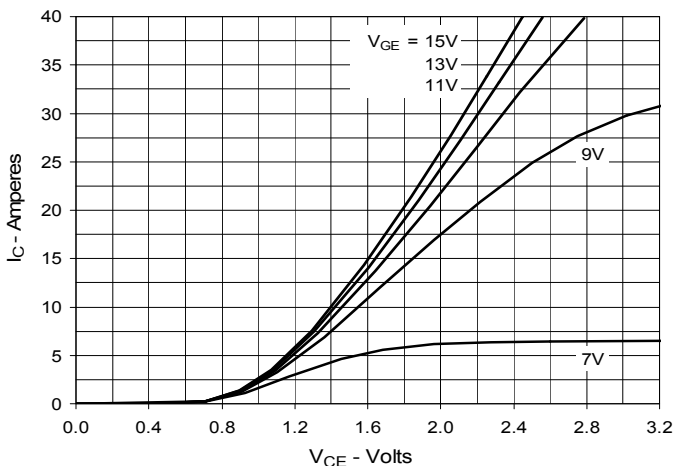

**Fig. 4. Dependence of VCE(sat) on Junction Temperature**

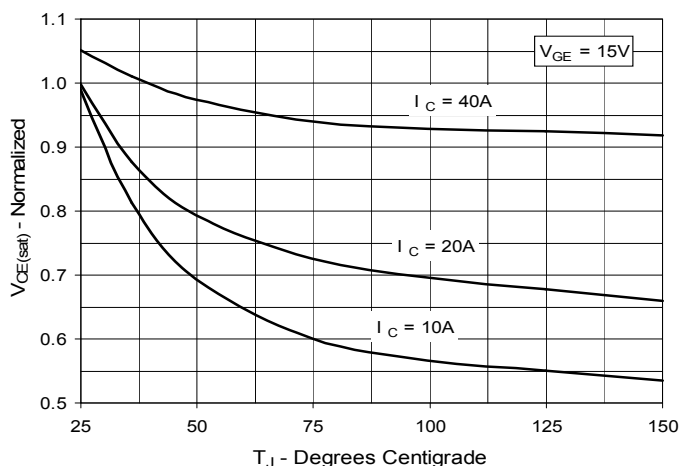

**Fig. 5. Collector-to-Emitter Voltage vs. Gate-to-Emitter Voltage**

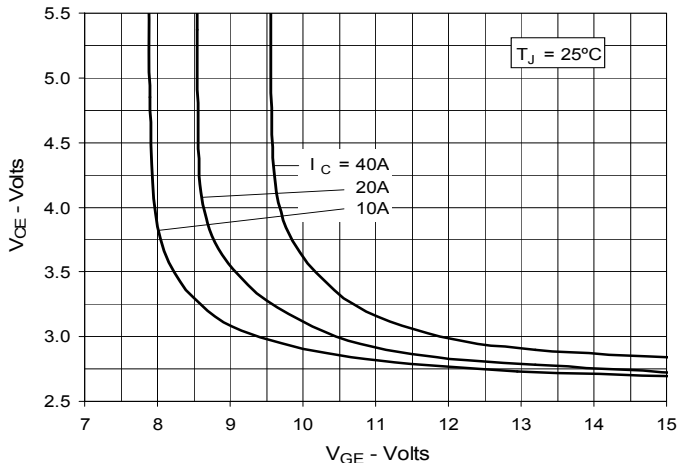

**Fig. 6. Input Admittance**

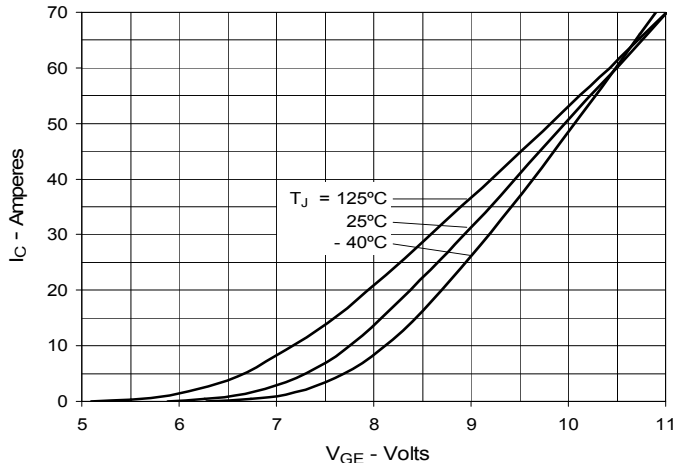

**Fig. 7. Transconductance**

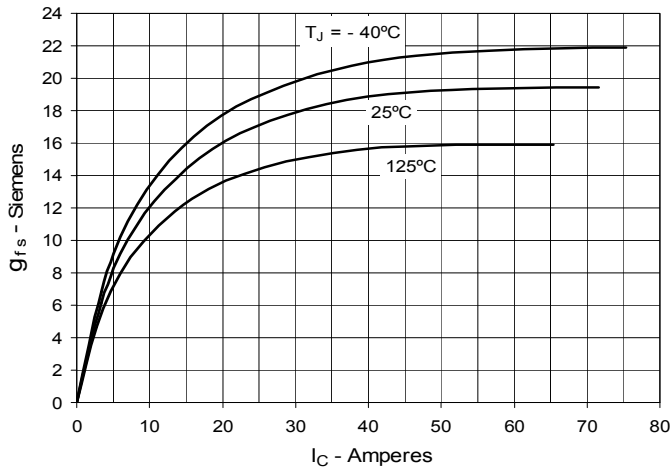

**Fig. 8. Gate Charge**

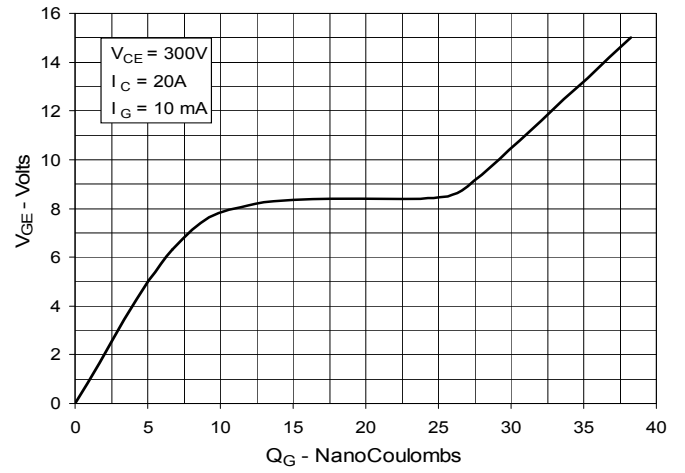

**Fig. 9. Capacitance**

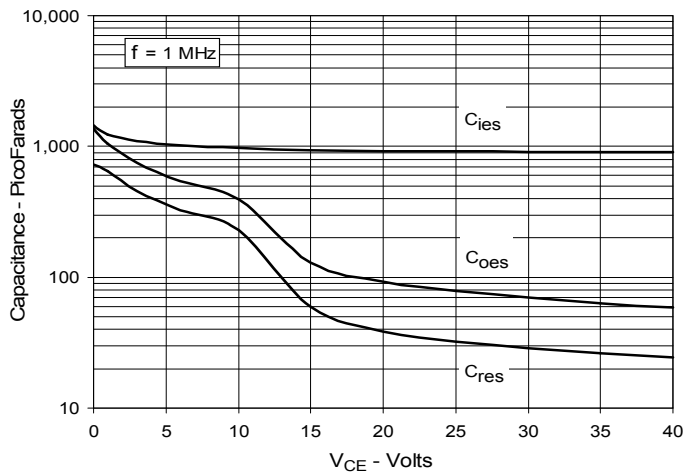

**Fig. 10. Reverse-Bias Safe Operating Area**

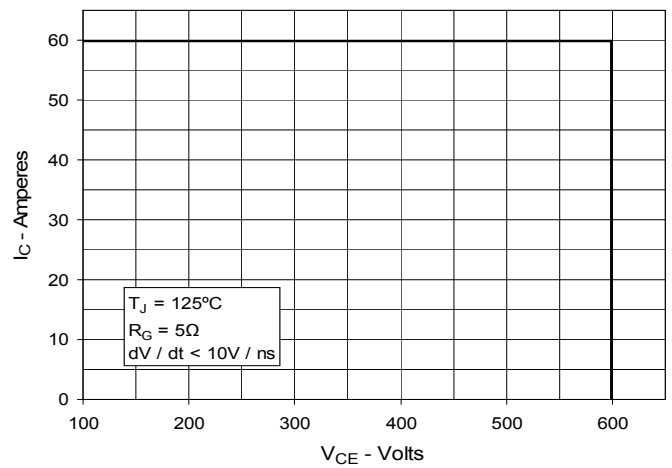

**Fig. 11. Maximum Transient Thermal Impedance**

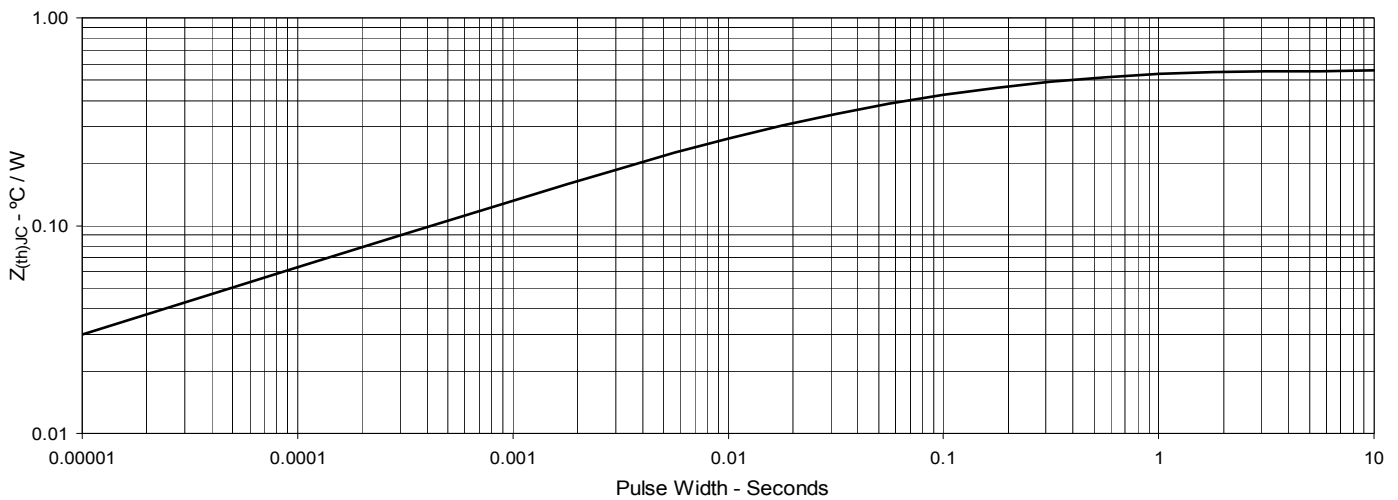

**Fig. 12. Inductive Switching Energy Loss vs. Gate Resistance**

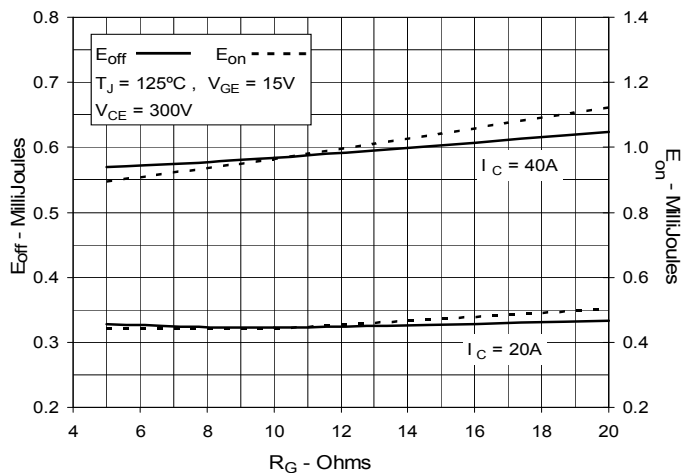

**Fig. 13. Inductive Switching Energy Loss vs. Collector Current**

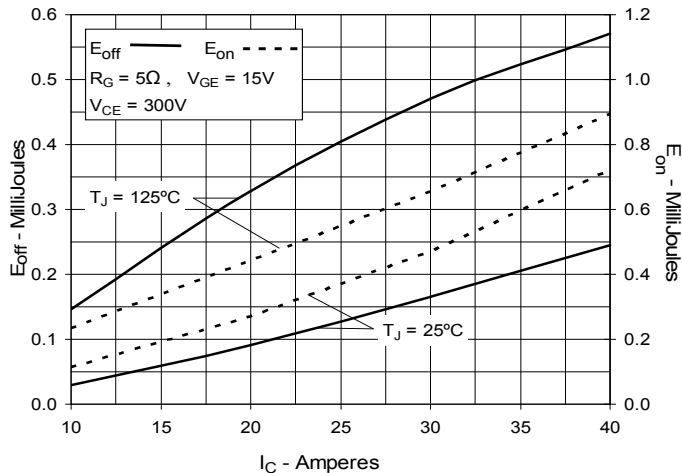

**Fig. 14. Inductive Switching Energy Loss vs. Junction Temperature**

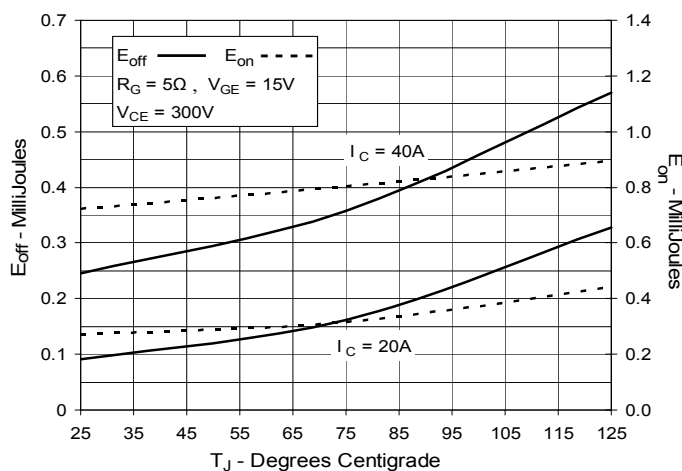

**Fig. 15. Inductive Turn-off Switching Times vs. Gate Resistance**

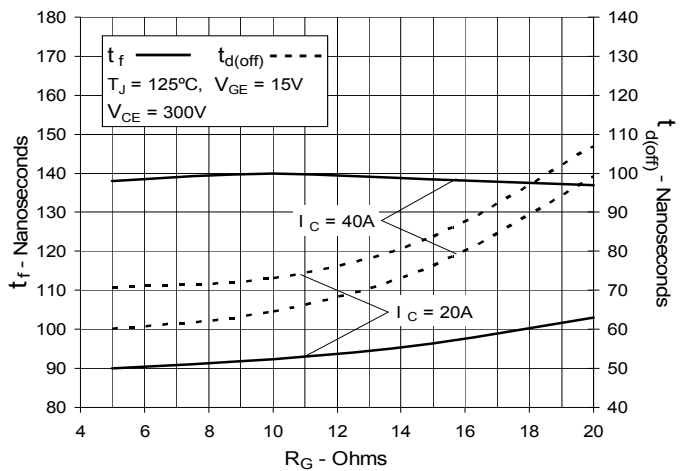

**Fig. 16. Inductive Turn-off Switching Times vs. Collector Current**

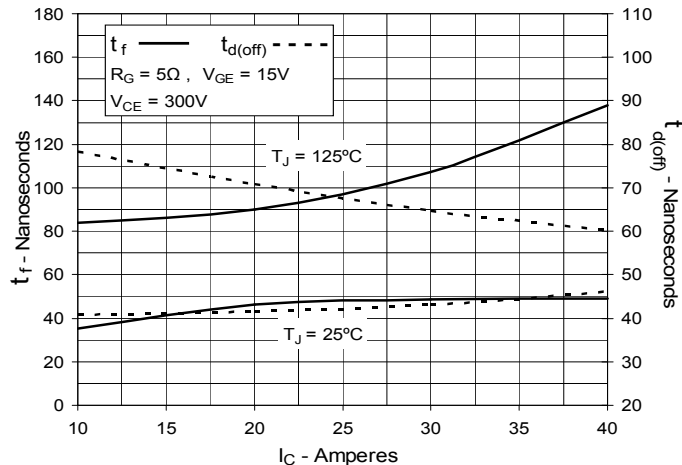

**Fig. 17. Inductive Turn-off Switching Times vs. Junction Temperature**

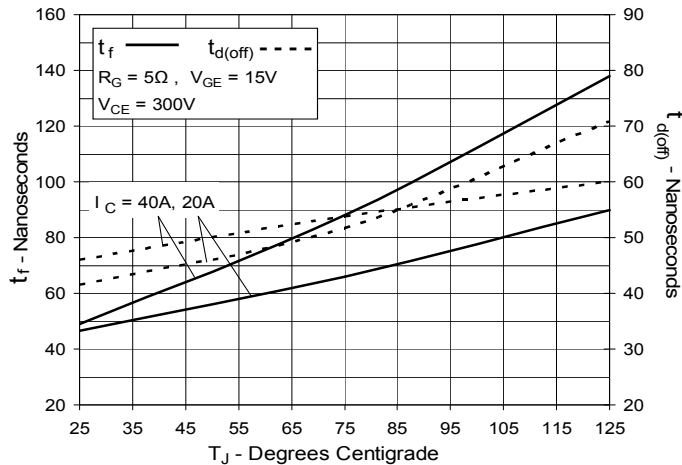

**Fig. 18. Inductive Turn-on  
Switching Times vs. Gate Resistance**

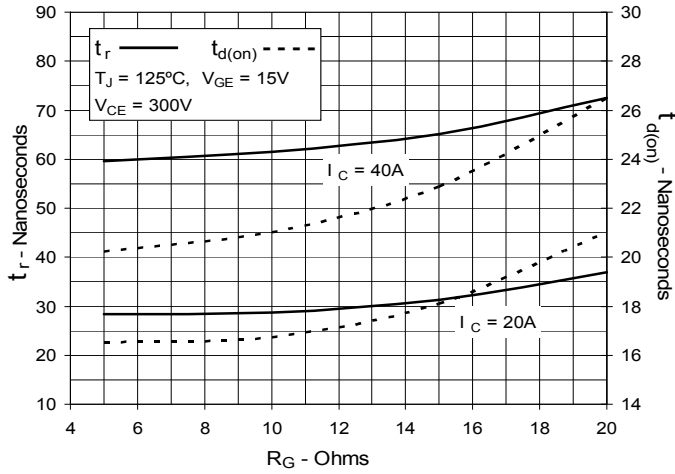

**Fig. 19. Inductive Turn-on  
Switching Times vs. Collector Current**

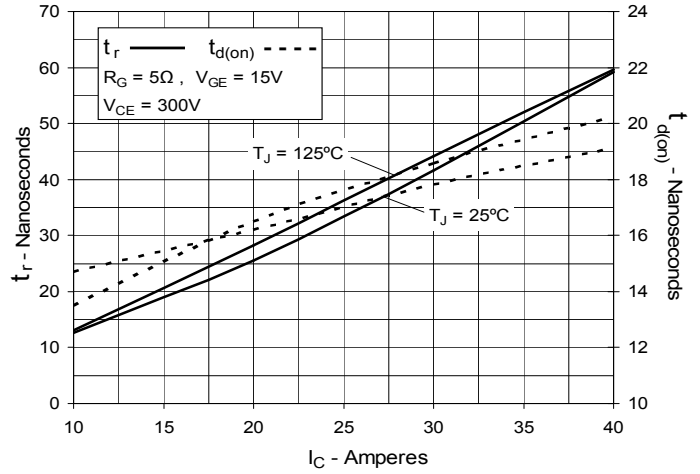

**Fig. 20. Inductive Turn-on  
Switching Times vs. Junction Temperature**

