

# GenX3™ 1200V IGBTs

## IXGA30N120B3 IXGP30N120B3 IXGH30N120B3

High-Speed Low-V<sub>sat</sub> PT IGBTs 3-20 kHz Switching

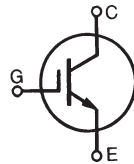

$V_{CES} = 1200V$   
 $I_{C110} = 30A$   
 $V_{CE(sat)} \leq 3.5V$   
 $t_{fi(typ)} = 204ns$

| Symbol                        | Test Conditions   | Maximum Ratings                        |            |
|-------------------------------|---|--|------------|
| $V_{CES}$                     | $T_C = 25^\circ C$ to $150^\circ C$   | 1200                                   | V          |
| $V_{CGR}$                     | $T_J = 25^\circ C$ to $150^\circ C$ , $R_{GE} = 1M\Omega$                           | 1200                                   | V          |
| $V_{GES}$                     | Continuous  | $\pm 20$                               | V          |
| $V_{GEM}$                     | Transient   | $\pm 30$                               | V          |
| $I_{C25}$                     | $T_C = 25^\circ C$  | 60                                     | A          |
| $I_{C110}$                    | $T_C = 110^\circ C$   | 30                                     | A          |
| $I_{CM}$                      | $T_C = 25^\circ C$ , 1ms  | 150                                    | A          |
| <b>SSOA</b><br><b>(RBSOA)</b> | $V_{GE} = 15V$ , $T_{VJ} = 125^\circ C$ , $R_G = 5\Omega$<br>Clamped Inductive Load | $I_{CM} = 60$<br>$V_{CE} \leq V_{CES}$ | A          |
| $P_C$                         | $T_C = 25^\circ C$  | 300                                    | W          |
| $T_J$                         |   | - 55 ... +150                          | $^\circ C$ |
| $T_{JM}$                      |   | 150                                    | $^\circ C$ |
| $T_{stg}$                     |   | - 55 ... +150                          | $^\circ C$ |
| $T_L$                         | 1.6mm (0.062 in.) from Case for 10s   | 300                                    | $^\circ C$ |
| $T_{SOLD}$                    | Plastic Body for 10 seconds   | 260                                    | $^\circ C$ |
| $M_d$                         | Mounting Torque (TO-220 & TO-247)   | 1.13/10                                | Nm/lb.in.  |
| <b>Weight</b>                 | TO-263  | 2.5                                    | g          |
|                               | TO-220  | 3.0                                    | g          |
|                               | TO-247  | 6.0                                    | g          |

TO-263 (IXGA)

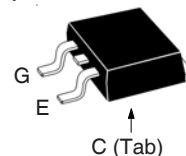

TO-220 (IXGP)

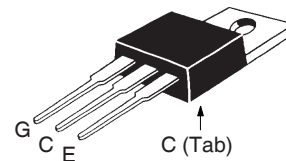

TO-247 (IXGH)

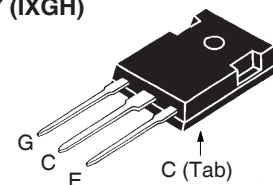

G = Gate      C = Collector  
E = Emitter    Tab = Collector

### Features

- Optimized for Low Conduction and Switching Losses
- Square RBSOA
- International Standard Packages

### Advantages

- High Power Density
- Low Gate Drive Requirement

### Applications

- Power Inverters
- UPS
- Motor Drives
- SMPS
- PFC Circuits
- Welding Machines

| Symbol        | Test Conditions<br>( $T_J = 25^\circ C$ , Unless Otherwise Specified) | Characteristic Values |      |                     |
|---------------|---|-----------------------|------|---------------------|
|               |   | Min.                  | Typ. | Max.                |
| $BV_{CES}$    | $I_C = 250\mu A$ , $V_{GE} = 0V$                                      | 1200                  |      | V                   |
| $V_{GE(th)}$  | $I_C = 250\mu A$ , $V_{CE} = V_{GE}$                                  | 3.0                   |      | 5.0 V               |
| $I_{CES}$     | $V_{CE} = V_{CES}$ , $V_{GE} = 0V$<br>$T_J = 125^\circ C$             |                       |      | 100 $\mu A$<br>1 mA |
| $I_{GES}$     | $V_{CE} = 0V$ , $V_{GE} = \pm 20V$                                    |                       |      | $\pm 100$ nA        |
| $V_{CE(sat)}$ | $I_C = 30A$ , $V_{GE} = 15V$ , Note 1<br>$T_J = 125^\circ C$          | 2.96<br>2.95          |      | 3.5 V<br>V          |

| Symbol       | Test Conditions<br>( $T_J = 25^\circ\text{C}$ , Unless Otherwise Specified)  | Characteristic Values |      |                    |                    |
|--------------|--|-----------------------|------|--------------------|--------------------|
|              |  | Min.                  | Typ. | Max.               |                    |
| $g_{fs}$     | $I_C = 30\text{A}, V_{CE} = 10\text{V}$ , Note 1   | 11                    | 19   | S                  |                    |
| $C_{ies}$    | $V_{CE} = 25\text{V}, V_{GE} = 0\text{V}, f = 1\text{MHz}$   |                       | 1750 | pF                 |                    |
| $C_{oes}$    |  |                       | 120  | pF                 |                    |
| $C_{res}$    |  |                       | 46   | pF                 |                    |
| $Q_g$        | $I_C = 30\text{A}, V_{GE} = 15\text{V}, V_{CE} = 0.5 \cdot V_{CES}$  |                       | 87   | nC                 |                    |
| $Q_{ge}$     |  |                       | 15   | nC                 |                    |
| $Q_{gc}$     |  |                       | 39   | nC                 |                    |
| $t_{d(on)}$  | <b>Inductive load, <math>T_J = 25^\circ\text{C}</math></b><br>$I_C = 30\text{A}, V_{GE} = 15\text{V}$<br>$V_{CE} = 0.8 \cdot V_{CES}, R_G = 5\Omega$<br>Notes 2  |                       | 16   | ns                 |                    |
| $t_{ri}$     |  |                       | 37   | ns                 |                    |
| $E_{on}$     |  |                       | 3.47 | mJ                 |                    |
| $t_{d(off)}$ |  |                       | 127  | ns                 |                    |
| $t_{fi}$     |  |                       | 204  | ns                 |                    |
| $E_{off}$    |  |                       | 2.16 | mJ                 |                    |
| $t_{d(on)}$  | <b>Inductive load, <math>T_J = 125^\circ\text{C}</math></b><br>$I_C = 30\text{A}, V_{GE} = 15\text{V}$<br>$V_{CE} = 0.8 \cdot V_{CES}, R_G = 5\Omega$<br>Notes 2 |                       | 18   | ns                 |                    |
| $t_{ri}$     |  |                       | 38   | ns                 |                    |
| $E_{on}$     |  |                       | 6.70 | mJ                 |                    |
| $t_{d(off)}$ |  |                       | 216  | ns                 |                    |
| $t_{fi}$     |  |                       | 255  | ns                 |                    |
| $E_{off}$    |  |                       | 5.10 | mJ                 |                    |
| $R_{thJC}$   | TO-220   |                       | 0.50 | $^\circ\text{C/W}$ |                    |
| $R_{thCS}$   |  | TO-247                |      |                    | $^\circ\text{C/W}$ |
| $R_{thCS}$   |  |                       |      |                    | $^\circ\text{C/W}$ |

### Notes:

- Pulse test,  $t \leq 300\mu\text{s}$ , duty cycle,  $d \leq 2\%$ .
- Switching times & energy losses may increase for higher  $V_{CE}$  (Clamp),  $T_J$  or  $R_G$ .

www.ixyssemi.com

### TO-263 (IXGA) Outline

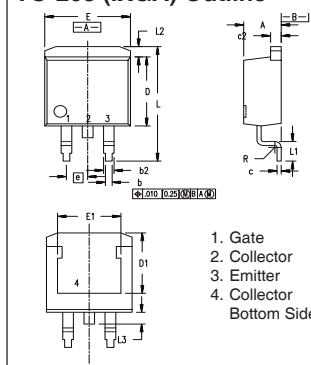

| Dim. | Millimeter |       | Inches |      |
|------|------------|-------|--------|------|
|      | Min.       | Max.  | Min.   | Max. |
| A    | 4.06       | 4.83  | .160   | .190 |
| b    | 0.51       | 0.99  | .020   | .039 |
| b2   | 1.14       | 1.40  | .045   | .055 |
| c    | 0.40       | 0.74  | .016   | .029 |
| c2   | 1.14       | 1.40  | .045   | .055 |
| D    | 8.64       | 9.65  | .340   | .380 |
| D1   | 8.00       | 8.89  | .280   | .320 |
| E    | 9.65       | 10.41 | .380   | .405 |
| E1   | 6.22       | 8.13  | .270   | .320 |
| e    | 2.54       | BSC   | .100   | BSC  |
| L    | 14.61      | 15.88 | .575   | .625 |
| L1   | 2.29       | 2.79  | .090   | .110 |
| L2   | 1.02       | 1.40  | .040   | .055 |
| L3   | 1.27       | 1.78  | .050   | .070 |
| L4   | 0          | 0.13  | 0      | .005 |

### TO-220 (IXGP) Outline

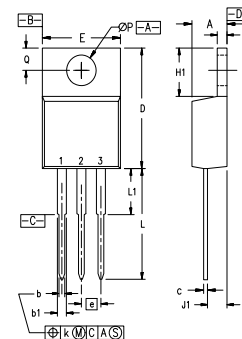

Pins: 1 - Gate 2 - Drain  
3 - Source 4 - Drain

| SYM | INCHES   |      | MILLIMETERS |       |
|-----|----------|------|-------------|-------|
|     | MIN      | MAX  | MIN         | MAX   |
| A   | .170     | .190 | 4.32        | 4.83  |
| b   | .025     | .040 | 0.64        | 1.02  |
| b1  | .045     | .065 | 1.15        | 1.65  |
| c   | .014     | .022 | 0.35        | 0.56  |
| D   | .580     | .630 | 14.73       | 16.00 |
| E   | .390     | .420 | 9.91        | 10.66 |
| e   | .100 BSC |      | 2.54 BSC    |       |
| F   | .045     | .055 | 1.14        | 1.40  |
| H1  | .230     | .270 | 5.85        | 6.85  |
| J1  | .090     | .110 | 2.29        | 2.79  |
| k   | 0        | .015 | 0           | 0.38  |
| L   | .500     | .550 | 12.70       | 13.97 |
| L1  | .110     | .230 | 2.79        | 5.84  |
| ØP  | .139     | .161 | 3.53        | 4.08  |
| Q   | .100     | .125 | 2.54        | 3.18  |

### TO-247 (IXGH) AD Outline

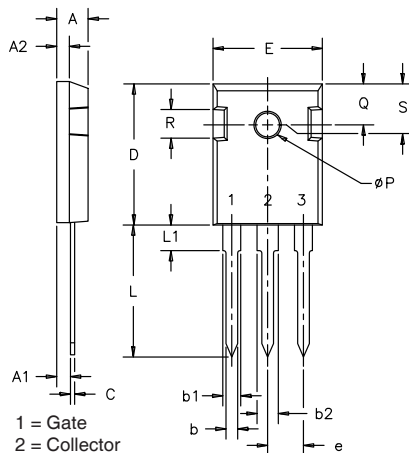

| SYM | INCHES   |      | MILLIMETERS |       |
|-----|----------|------|-------------|-------|
|     | MIN      | MAX  | MIN         | MAX   |
| A   | .185     | .209 | 4.7         | 5.3   |
| A1  | .087     | .102 | 2.2         | 2.54  |
| A2  | .059     | .098 | 2.2         | 2.6   |
| b   | .040     | .055 | 1.0         | 1.4   |
| b1  | .065     | .084 | 1.65        | 2.13  |
| b2  | .113     | .123 | 2.87        | 3.12  |
| C   | .016     | .031 | .4          | .8    |
| D   | .819     | .845 | 20.80       | 21.46 |
| E   | .610     | .640 | 15.75       | 16.26 |
| e   | .215 BSC |      | 5.45 BSC    |       |
| L   | .780     | .800 | 19.81       | 20.32 |
| L1  | .177     |      | 4.50        |       |
| ØP  | .140     | .144 | 3.55        | 3.65  |
| Q   | .212     | .244 | 5.4         | 6.2   |
| R   | .170     | .216 | 4.32        | 5.49  |
| S   | .242 BSC |      | 6.15 BSC    |       |

IXYS Reserves the Right to Change Limits, Test Conditions, and Dimensions.

|  |           |           |           |           |              |              |              |              |              |              |
|--|-----------|-----------|-----------|-----------|--------------|--------------|--------------|--------------|--------------|--------------|
| IXYS MOSFETs and IGBTs are covered by one or more of the following U.S. patents: | 4,835,592 | 4,931,844 | 5,049,961 | 5,237,481 | 6,162,665    | 6,404,065 B1 | 6,683,344    | 6,727,585    | 7,005,734 B2 | 7,157,338 B2 |
|  | 4,850,072 | 5,017,508 | 5,063,307 | 5,381,025 | 6,259,123 B1 | 6,534,343    | 6,710,405 B2 | 6,759,692    | 7,063,975 B2 |              |
|  | 4,881,106 | 5,034,796 | 5,187,117 | 5,486,715 | 6,306,728 B1 | 6,583,505    | 6,710,463    | 6,771,478 B2 | 7,071,537    |              |

**Fig. 1. Output Characteristics @  $T_J = 25^\circ\text{C}$**

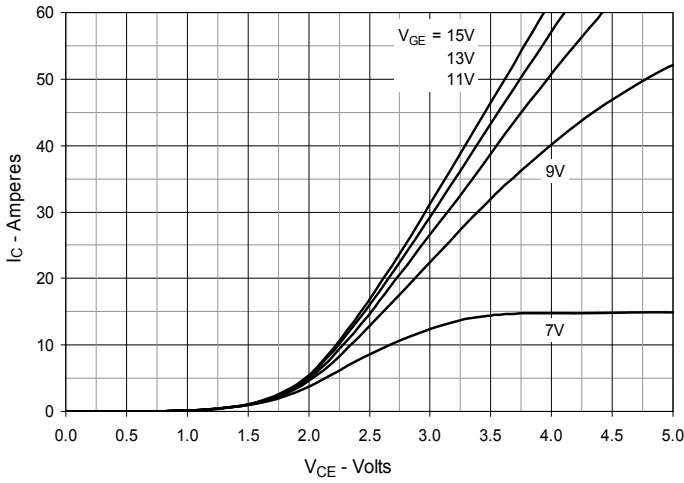

**Fig. 2. Extended Output Characteristics @  $T_J = 25^\circ\text{C}$**

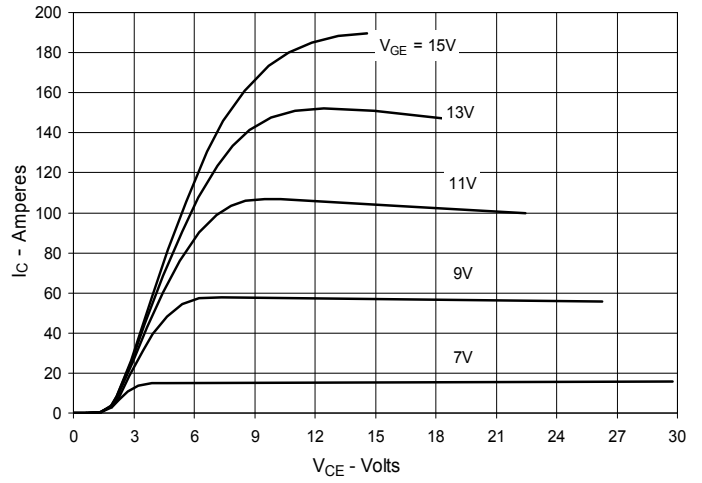

**Fig. 3. Output Characteristics @  $T_J = 125^\circ\text{C}$**

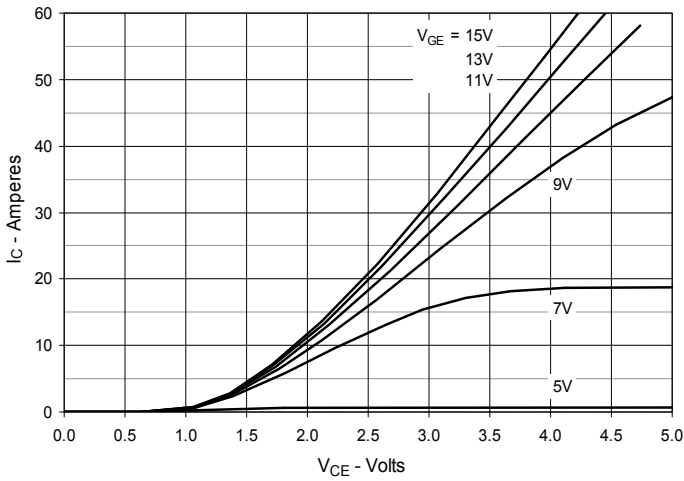

**Fig. 4. Dependence of  $V_{CE(sat)}$  on Junction Temperature**

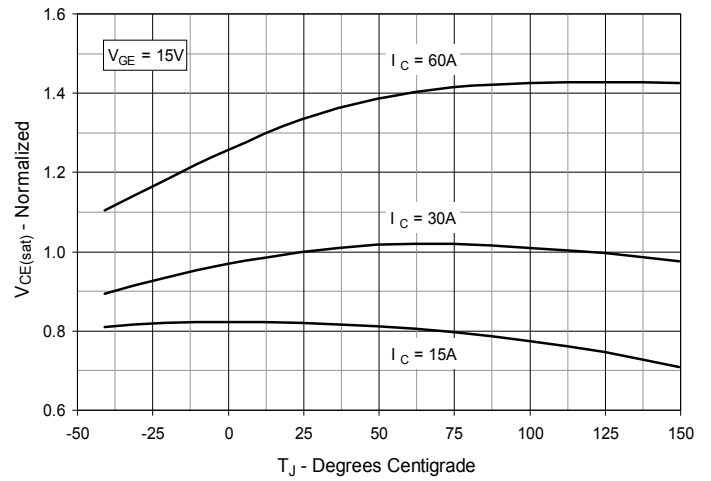

**Fig. 5. Collector-to-Emitter Voltage vs. Gate-to-Emitter Voltage**

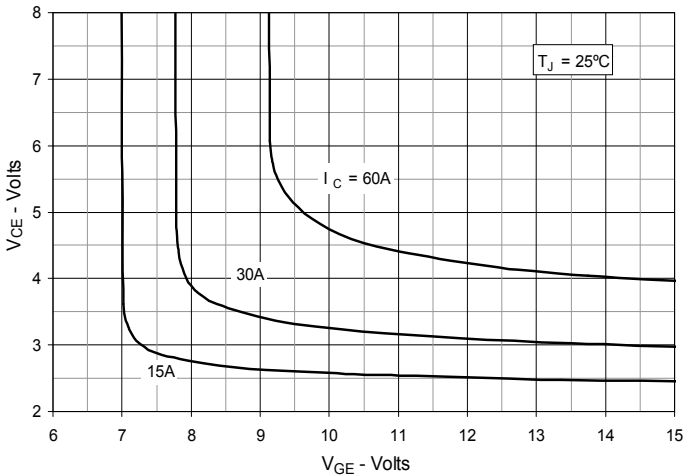

**Fig. 6. Input Admittance**

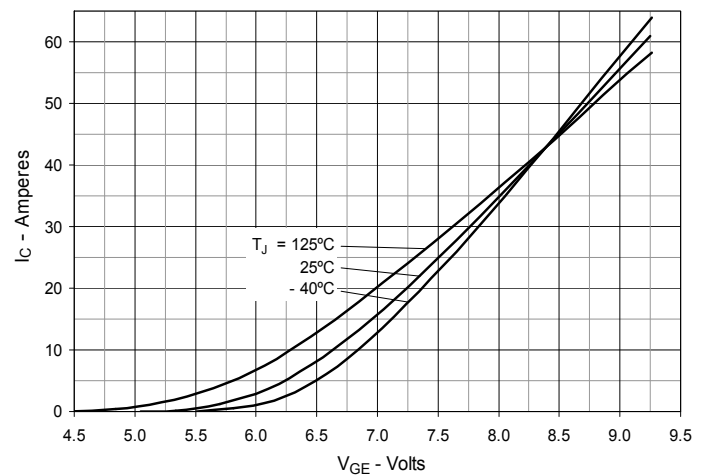

Fig. 7. Transconductance

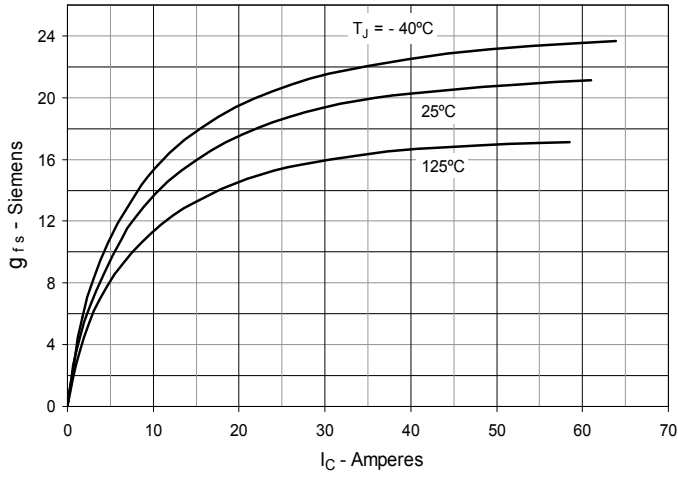

Fig. 8. Gate Charge

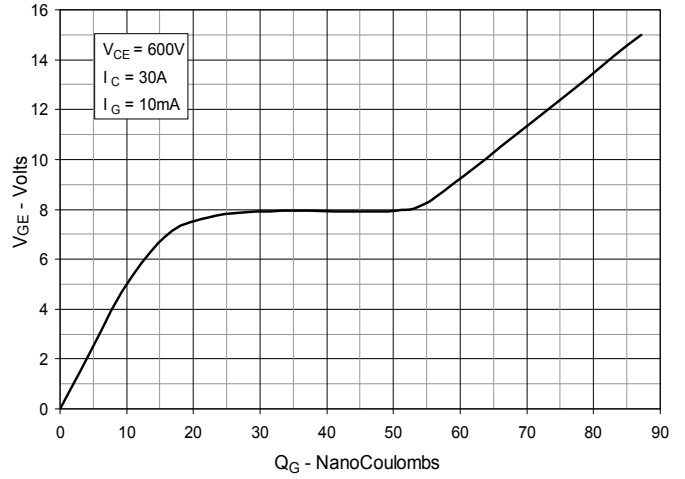

Fig. 9. Capacitance

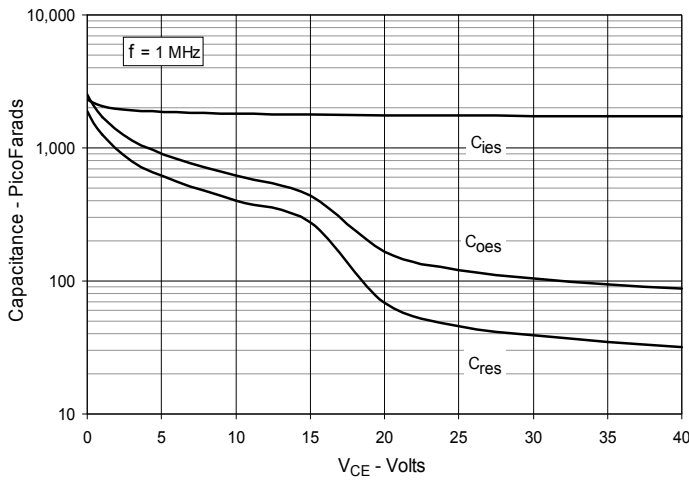

Fig. 10. Reverse-Bias Safe Operating Area

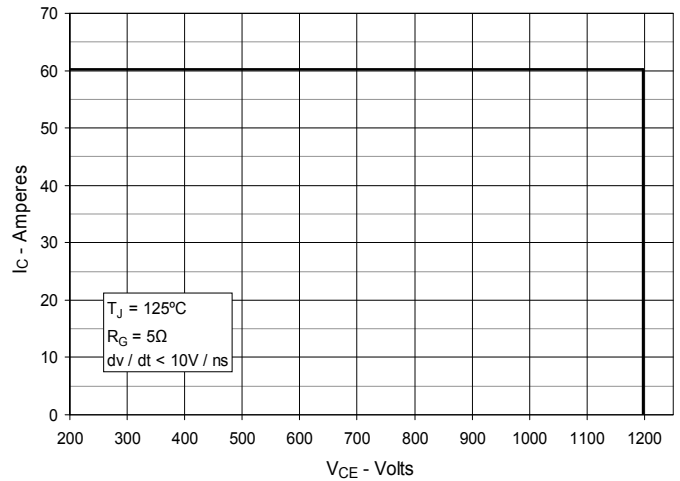
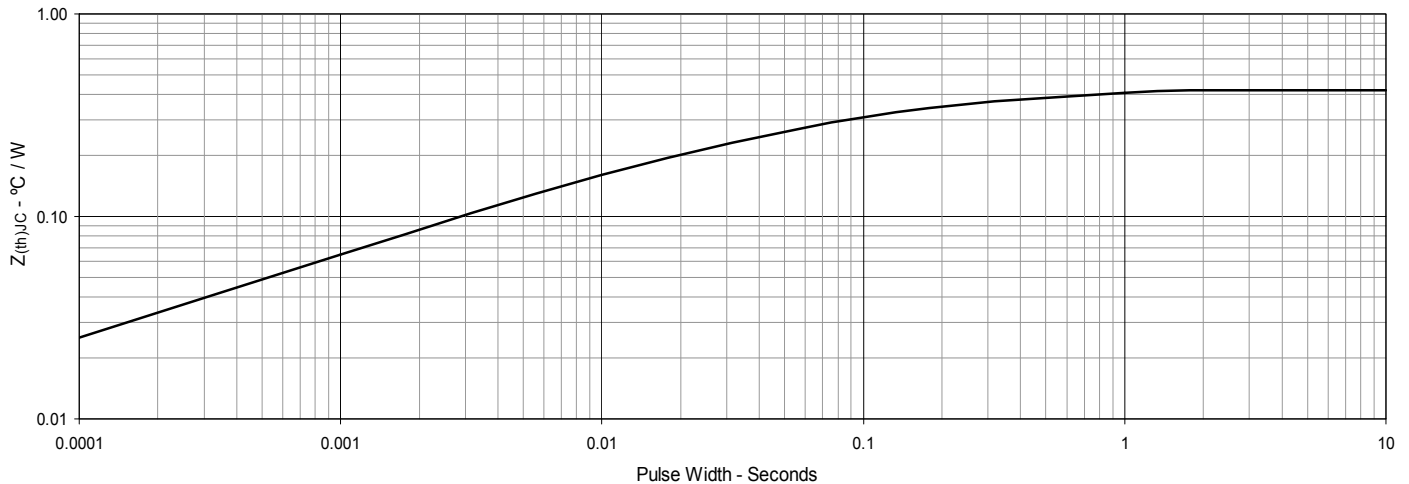
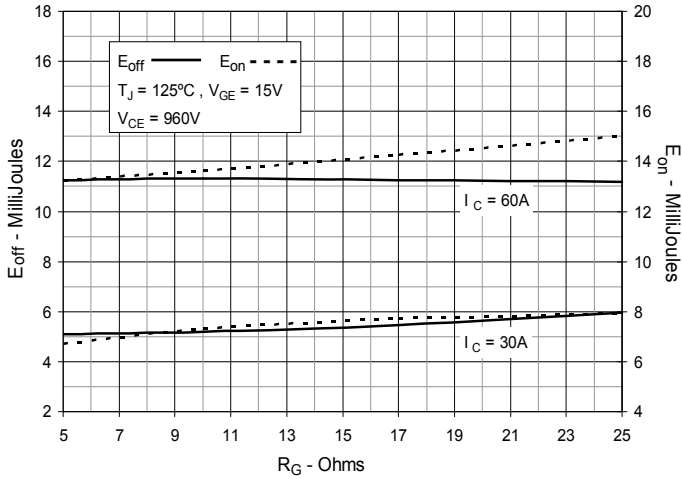

Fig. 11. Maximum Transient Thermal Impedance



**Fig. 12. Inductive Switching  
Energy Loss vs. Gate Resistance**



**Fig. 13. Inductive Switching  
Energy Loss vs. Collector Current**

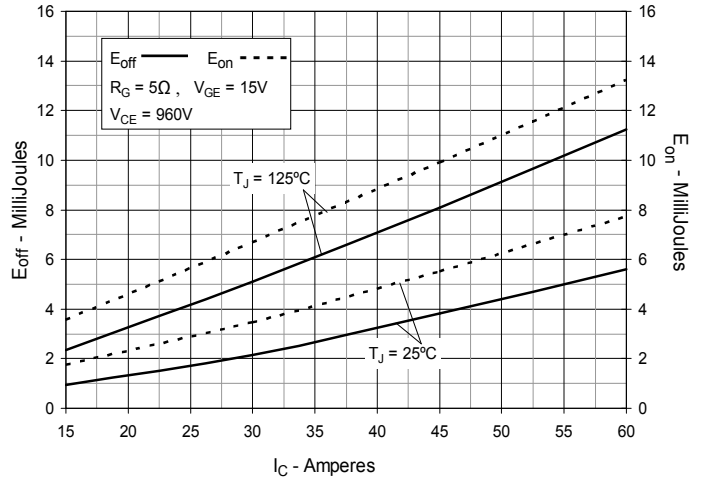

**Fig. 14. Inductive Switching  
Energy Loss vs. Junction Temperature**

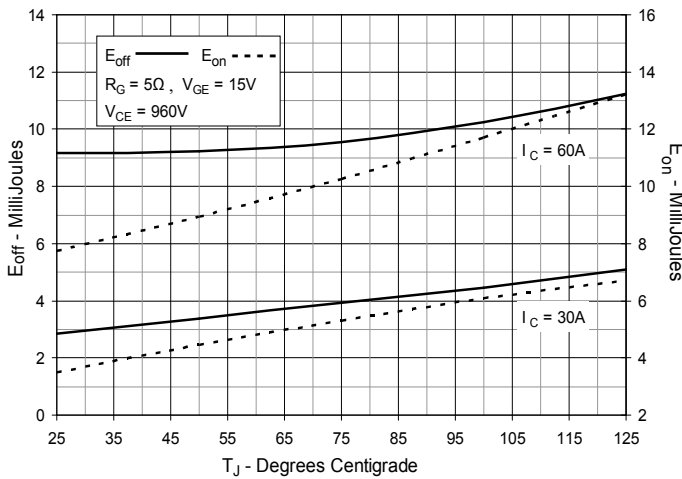

**Fig. 15. Inductive Turn-off  
Switching Times vs. Gate Resistance**

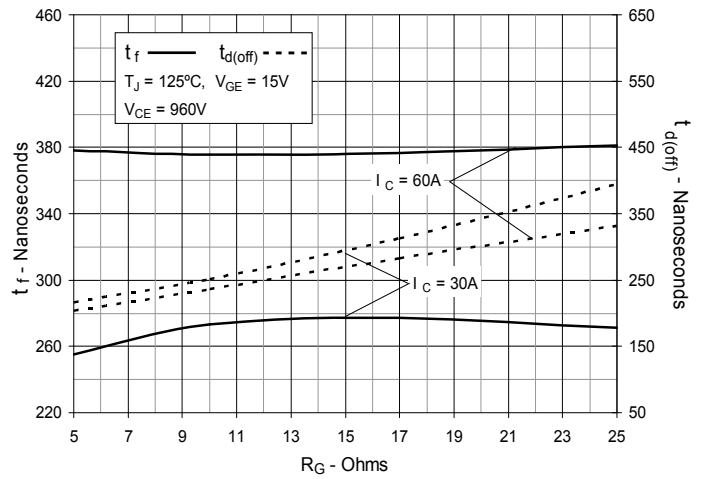

**Fig. 16. Inductive Turn-off  
Switching Times vs. Collector Current**

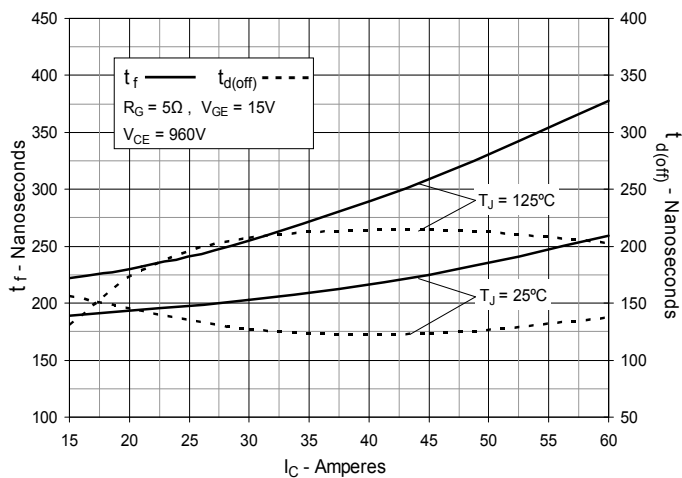

**Fig. 17. Inductive Turn-off  
Switching Times vs. Junction Temperature**

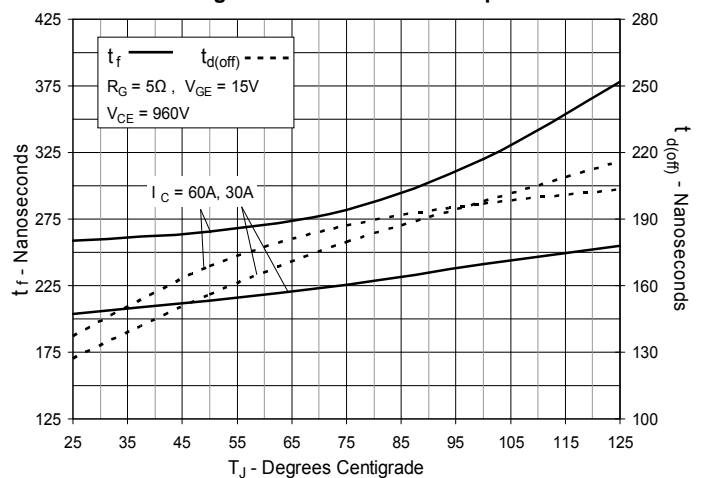

**Fig. 18. Inductive Turn-on  
Switching Times vs. Gate Resistance**

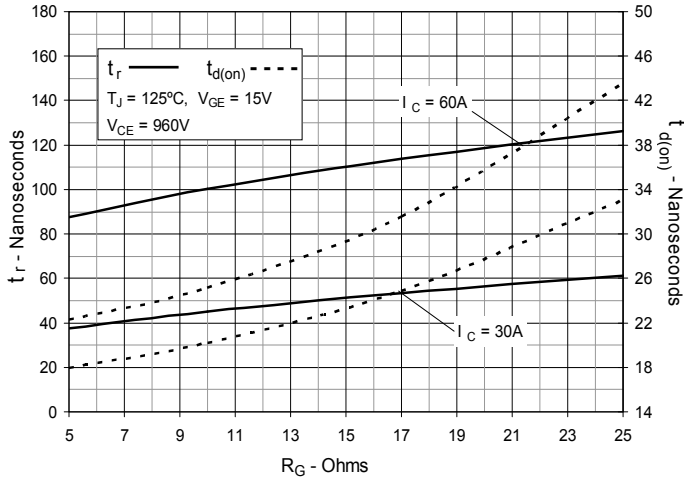

**Fig. 19. Inductive Turn-on  
Switching Times vs. Collector Current**

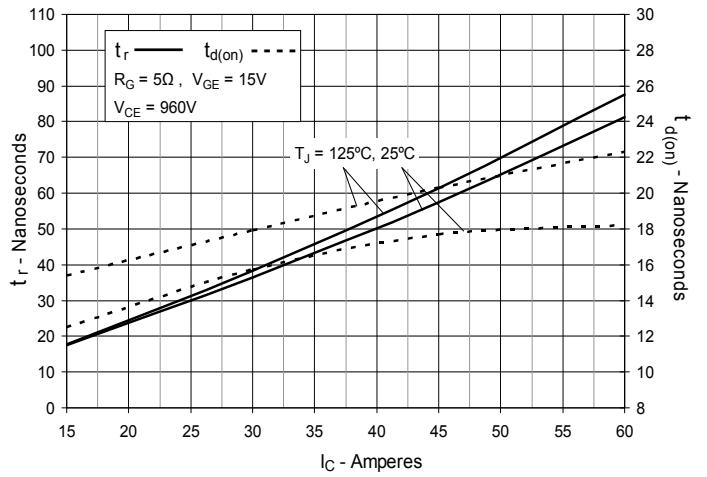

**Fig. 20. Inductive Turn-on  
Switching Times vs. Junction Temperature**

