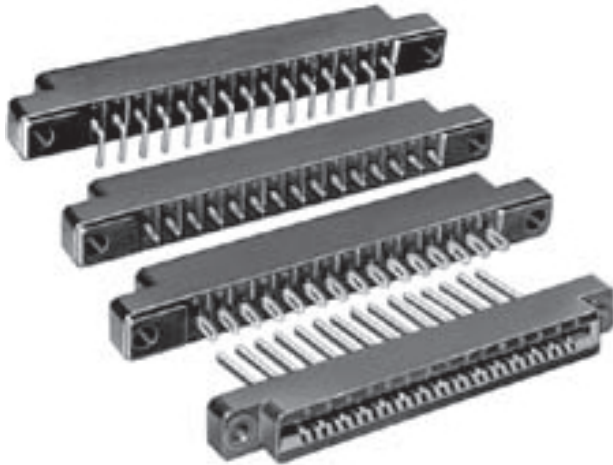

Edgeboard Connectors

Single Readout, Dip Solder, Eyelet and Wire Wrap™ Termination

FEATURES

- 0.156" [3.96mm] C-C.
- Modified tuning fork contacts have chamfered lead-in to reduce wear on printed circuit board contacts without sacrificing contact pressure and wiping action.
- Accepts PC board thickness of 0.054" to 0.070" [1.37mm to 1.78mm].
- Polarization on or between contact position in all sizes. Between contact polarization permits polarizing without loss of a contact position.
- Polarizing key is reinforced nylon, may be inserted by hand, requires no adhesive.
- Protected entry, provided by recessed leading edge of contact, permits the card slot to straighten and align the board before electrical contact is made. Prevents damage to contacts which might be caused by warped or out of tolerance boards.
- Optional terminal configurations, including eyelet (Type A), dip-solder (Types B, C, D, R), Wire Wrap™ (Types E, F).
- **Connectors with Type A, B, C, D or R contacts are recognized under the Component Program of Underwriters Laboratories, Inc. Listed under File 65524, Project 77CH3889.**

ELECTRICAL SPECIFICATIONS

Current Rating: 5 amps.

Test Voltage Between Contacts:

At Sea Level: 1800VRMS.

At 70,000 feet [21,336 meters]: 450VRMS.

Insulation Resistance: 5000 Megohm minimum.

Contact Resistance: (Voltage Drop) 30 millivolts maximum at rated current with gold flash.

PHYSICAL SPECIFICATIONS

Number of Contacts: 6, 10, 12, 15, 18 or 22.

Contact Spacing: 0.156" [3.96mm].

Card Thickness: 0.054" to 0.070" [1.37mm to 1.78mm].

Card Slot Depth: 0.330" [8.38mm].

APPLICATIONS

For use with 0.062" [1.57mm] printed circuit boards requiring an edgeboard type connector on 0.156" [3.96mm] centers.

MATERIAL SPECIFICATIONS

Body: Glass-filled phenolic per MIL-M-14, Type MFH, black, flame retardant (UL 94V-0).

Contacts: Copper alloy.

Finish: 1 = Electro tin plated. 2 = Gold flash.

Polarizing Key: Glass-filled nylon.

Optional Threaded Mounting Insert: Nickel plated brass (Type Y).

Optional Floating Mounting Bushing: Cadmium plated brass (Type Z).

ORDERING INFORMATION

EBT156 MODEL	10 CONTACTS	A CONTACT TERMINAL VARIATIONS	1 CONTACT FINISH	X MOUNTING VARIATIONS	A, J BETWEEN CONTACT POLARIZATION	A9, J9 ON CONTACT POLARIZATION
	6, 10, 12, 15, 18, 22	A, B, C, D, E, F, R	1 = Electro Tin Plated 2 = Gold Flash	W, X, Y, Z		
			Required only when polarizing key(s) are to be factory installed . Polarization key positions: Between contact polarization key(s) are located to the right of the contact position(s) desired. Example: A, J means keys between A and B , and J and K .			Required only when polarizing key(s) are to be factory installed . Polarization key replaces contact. When polarizing key(s) replaces contact(s), indicate by adding suffix "9" to contact position(s) desired. Example: A9, J9 means keys replace terminals A and J .

DIMENSIONS in inches [millimeters]

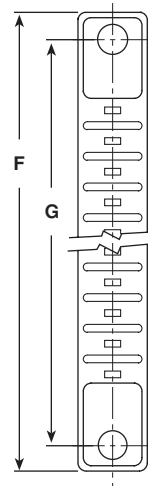
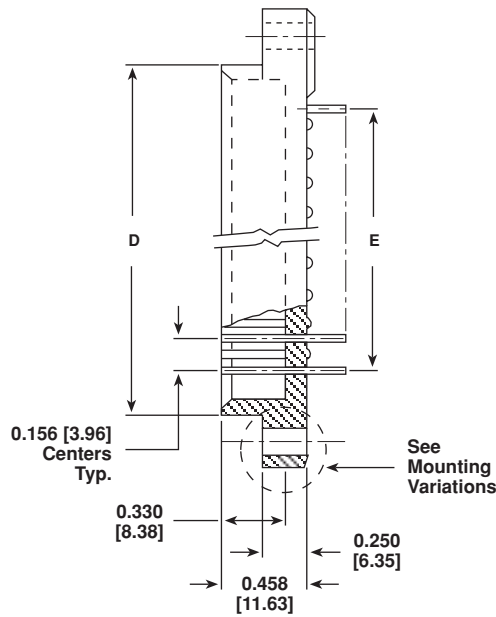
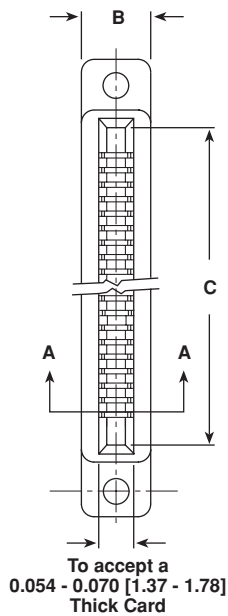

Section A-A

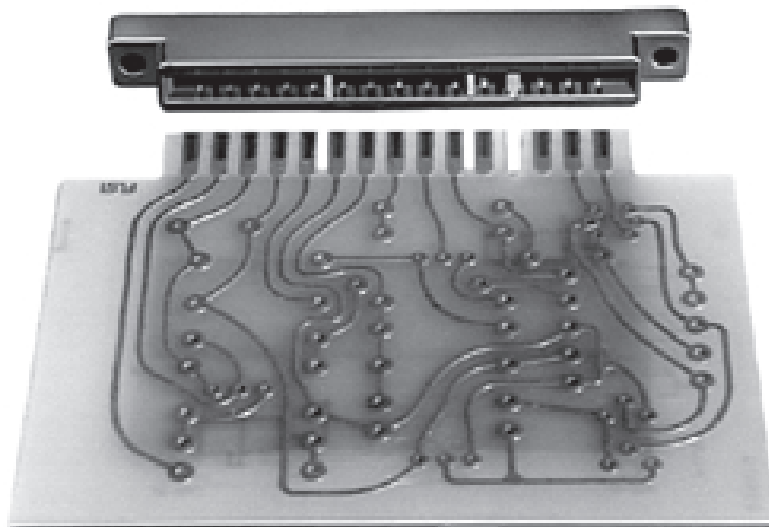
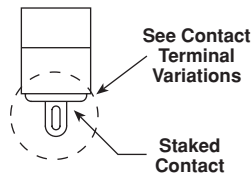
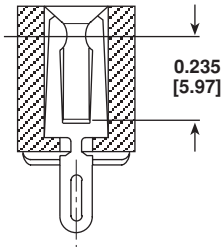

Between contact or on contact polarization available in all sizes for factory or field insertion.

# OF CONTACT POSITIONS	B	C	D	E	F	G
6	0.340 [8.64]	1.10 [27.94]	1.24 [31.50]	0.781 [19.84]	1.80 [45.72]	1.53 [38.86]
10	0.340 [8.64]	1.72 [43.69]	1.86 [47.24]	1.41 [35.81]	2.43 [61.72]	2.16 [54.86]
12	0.340 [8.64]	2.04 [51.82]	2.18 [55.37]	1.72 [43.69]	2.74 [69.60]	2.47 [62.74]
15	0.340 [8.64]	2.50 [63.50]	2.65 [67.31]	2.19 [55.63]	3.21 [81.53]	2.94 [74.68]
18	0.340 [8.64]	2.97 [75.44]	3.11 [78.99]	2.66 [67.56]	3.68 [93.47]	3.41 [86.61]
22	0.340 [8.64]	3.60 [91.44]	3.74 [95.0]	3.28 [83.31]	4.30 [109.22]	4.03 [102.36]

