

PRELIMINARY DATA SHEET

AV104-12: GaAs IC 25 dB Voltage Variable Attenuator Single Positive Control 0.45–2.5 GHz

Features

- Single positive +5 V control voltage
- 25 dB attenuation range @ 0.9 GHz
- High IP3 (20 dBm @ 0.9 GHz)
- Excellent linearity performance

SOIC-8

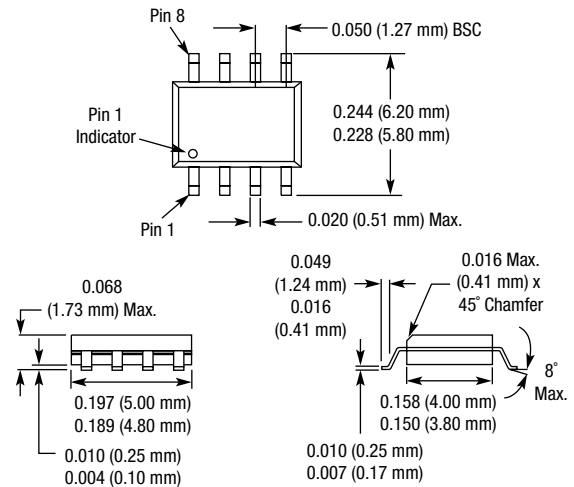

Description

The AV104-12 GaAs IC FET voltage variable attenuator provides 25 dB attenuation range at 900 MHz controlled by a single positive voltage. The VVA has a linear transfer curve of 5 dB/V slope, with input and output VSWR better than 1.4:1 over all states. Its attenuation range at 1900 MHz is 22 dB. It operates with supply voltage of +5 V and control voltage of 0 V to +5 V in a low cost SOIC-8 package. The RF ports require 25 pF DC blocking capacitors.

Electrical Specifications at 25 °C (V_S = 5 V)

Parameter ⁽¹⁾	Frequency	Min.	Typ.	Max.	Unit
Insertion loss (V _C = 5 V)	0.45–1.00 GHz		2.7	3.0	dB
	1.00–2.00 GHz		3.0	3.4	dB
	2.00–2.50 GHz		3.2	3.7	dB
Maximum attenuation (V _C = 0 V) ⁽²⁾	0.45–0.80 GHz	15	20		dB
	0.80–1.00 GHz	21	25		dB
	1.00–1.70 GHz	19	23		dB
	1.70–2.00 GHz	17	21		dB
	2.00–2.50 GHz	15	19		dB
VSWR (I/O) ⁽³⁾	0.45–2.50 GHz		1.4:1		

Operating Characteristics at 25 °C (V_S = 5 V)

Parameter	Condition	Frequency	Min.	Typ.	Max.	Unit
Switching characteristics	Rise, on (10/90% or 50% CTL to 90% RF)			1.0		ms
	Fall, off (90/10% RF or 50% CTL to 10% RF)			1.5		ms
Intermodulation intercept point (IIP3) ⁽³⁾	For two-tone input power +0 dBm	0.9 GHz		20		dBm
Control voltage (V _C)			0		V _S	V
Supply voltage (V _S)				5.0		V
Control current (I _C)				2.5		mA
Supply current (I _S)				2.5		mA

1. All measurements made in a 50 Ω system, unless otherwise specified.
 2. Maximum attenuation includes insertion loss.
 3. For worst case state.

Typical Performance Data @ 0.9 GHz

(Unless Otherwise Specified)

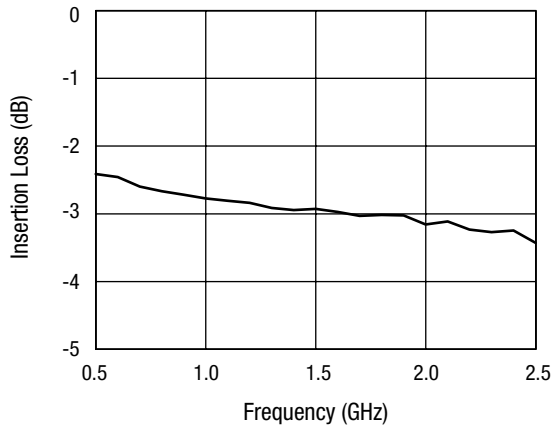

Insertion Loss vs. Frequency

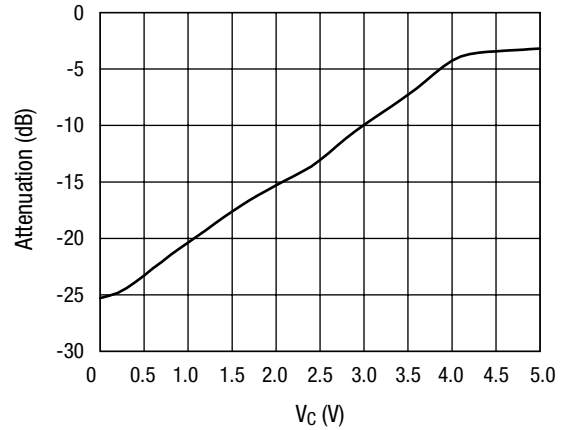

Attenuation vs. Control Voltage

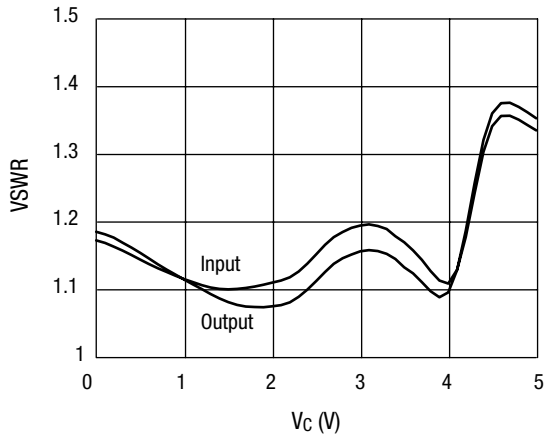

VSWR vs. Control Voltage

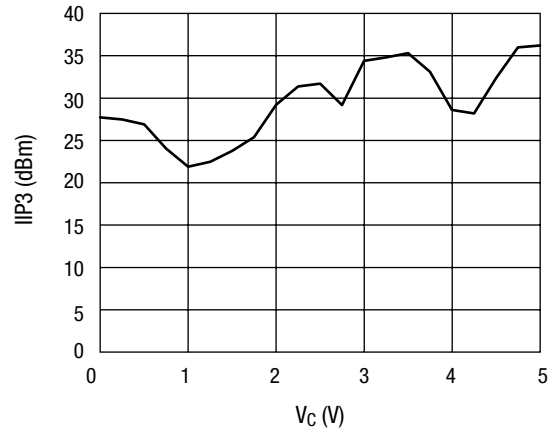

Input IP3 vs. Control Voltage

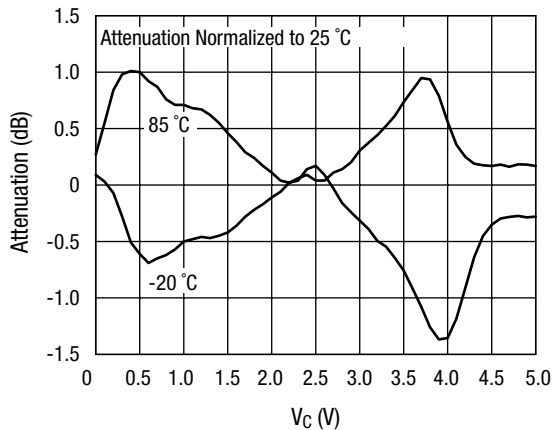

Attenuation vs. Control Voltage Over Temperature

Absolute Maximum Ratings

Characteristic	Value
RF input power	100 mW > 500 MHz
Supply voltage	+4 to +8 V
Control voltage	$-0.2 \text{ V} < V_C < V_S + 0.2 \text{ V}$
Operating temperature	-40 °C to +85 °C
Storage temperature	-65 °C to +150 °C
Θ_{JC}	25 °C/W

Note: Exceeding these parameters may cause irreversible damage.

Pin Out

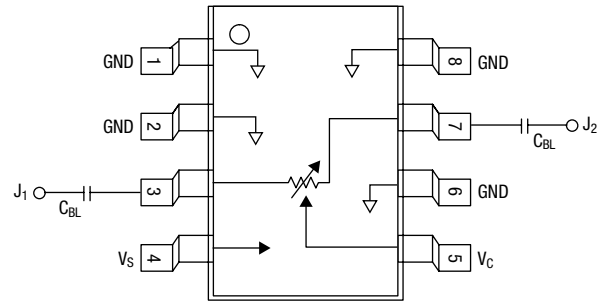

DC blocking capacitors (C_{BL}) supplied externally.
 $C_{BL} = 25 \text{ pF}$ for operation >450 MHz.