

High Slew Rate, Wide Bandwidth, JFET Input Operational Amplifiers

These devices are a new generation of high speed JFET input monolithic operational amplifiers. Innovative design concepts along with JFET technology provide wide gain bandwidth product and high slew rate. Well matched JFET input devices and advanced trim techniques ensure low input offset errors and bias currents. The all NPN output stage features large output voltage swing, no deadband crossover distortion, high capacitive drive capability, excellent phase and gain margins, low open-loop output impedance, and symmetrical source/sink AC frequency response.

This series of devices are available in fully compensated or decompensated ($A_{VCL} \geq 2$) and are specified over commercial or Military temperature ranges. They are pin compatible with existing industry standard operational amplifiers, and allow the designer to easily upgrade the performance of existing designs.

- **Wide Gain Bandwidth:** 8.0 MHz for Fully Compensated Devices
16 MHz for Decompensated Devices
- **High Slew Rate:** 25 V/ μ s for Fully Compensated Devices
50 V/ μ s for Decompensated Devices
- **High Input Impedance:** $10^{12} \Omega$
- **Input Offset Voltage:** 0.5 mV Maximum (Single Amplifier)
- **Large Output Voltage Swing:** -14.7 V to +14 V for
 $V_{CC}/V_{EE} = \pm 15$ V
- **Low Open-Loop Output Impedance:** 30 Ω @ 1.0 MHz
- **Low THD Distortion:** 0.01%
- **Excellent Phase/Gain Margins:** 55°/7.6 dB for Fully Compensated Devices

ORDERING INFORMATION

Op Amp Function	Fully Compensated	$A_{VCL} \geq 2$ Compensated	Temperature Range	Package
Single	MC35081BU	MC35080BU	-55° to +125°C	Ceramic DIP
	MC34081BD	MC34080BD		SO-8
	MC34081BP	MC34080BP	0° to +70°C	Plastic DIP
Dual	MC34082P	MC34083P		Plastic DIP
Quad	MC35084L	MC35085L	-55° to +125°C	Ceramic DIP
	MC34084DW	MC34085DW		SO-16L
	MC34084P	MC34085P	0° to +70°C	Plastic DIP

MC34080/MC35080
thru
MC34085/MC35085

HIGH PERFORMANCE JFET INPUT OPERATIONAL AMPLIFIERS



P SUFFIX
PLASTIC PACKAGE
CASE 626



U SUFFIX
CERAMIC PACKAGE
CASE 693

D SUFFIX
PLASTIC PACKAGE
CASE 751
(SO-8)



PIN CONNECTIONS

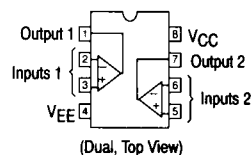
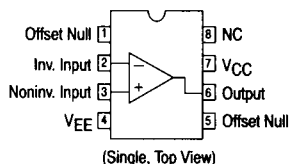

P SUFFIX
PLASTIC PACKAGE
CASE 646

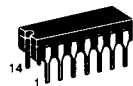

L SUFFIX
CERAMIC PACKAGE
CASE 632

PIN CONNECTIONS

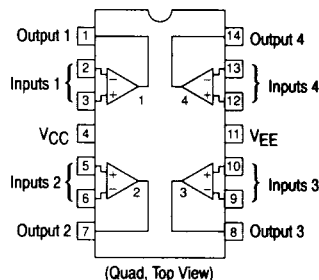
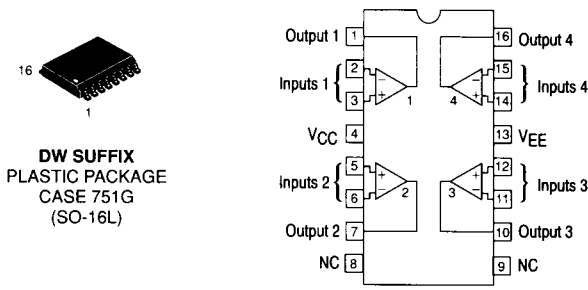

MC34080, MC35080 Series

MAXIMUM RATINGS

Rating	Symbol	Value	Unit
Supply Voltage (from V_{CC} to V_{EE})	V_S	+44	V
Input Differential Voltage Range	V_{IDR}	(Note 1)	V
Input Voltage Range	V_{IR}	(Note 1)	V
Output Short Circuit Duration (Note 2)	t_{SC}	Indefinite	sec
Operating Ambient Temperature Range MC35XXX MC34XXX	T_A	-55 to +125 0 to +70	°C
Operating Junction Temperature Ceramic Package Plastic Package	T_J	+165 +125	°C
Storage Temperature Range Ceramic Package Plastic Package	T_{stg}	-65 to +165 -55 to +125	°C

- NOTES: 1. Either or both input voltages must not exceed the magnitude of V_{CC} or V_{EE} .
 2. Power dissipation must be considered to ensure maximum junction temperature (T_J) is not exceeded.

Equivalent Circuit Schematic
(Each Amplifier)

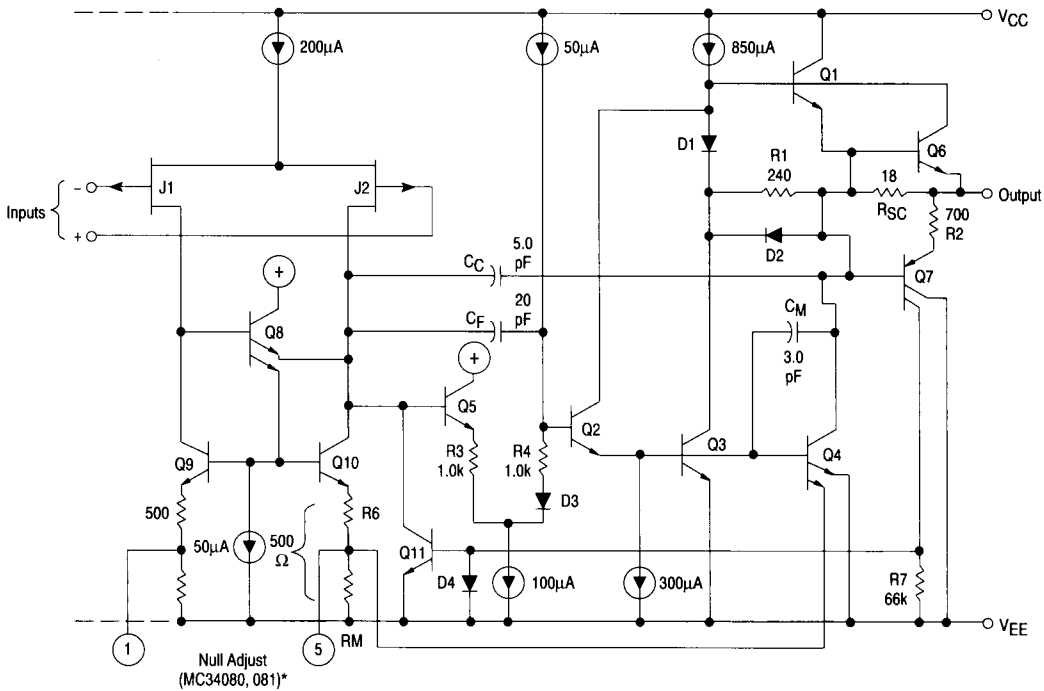

*Pins 1 & 5 (MC34080,081) should not be directly grounded or connected to V_{CC} .

MC34080, MC35080 Series

DC ELECTRICAL CHARACTERISTICS ($V_{CC} = +15\text{ V}$, $V_{EE} = -15\text{ V}$, $T_A = T_{\text{low}}$ to T_{high} [Note 3], unless otherwise noted.)

2

Characteristics	Symbol	Min	Typ	Max	Unit
Input Offset Voltage (Note 4) Single $T_A = +25^\circ\text{C}$ $T_A = 0^\circ$ to $+70^\circ\text{C}$ (MC34080B, MC34081B) $T_A = -55^\circ$ to $+125^\circ\text{C}$ (MC35080B, MC35081B) Dual $T_A = +25^\circ\text{C}$ $T_A = 0^\circ$ to $+70^\circ\text{C}$ (MC34082, MC34083) Quad $T_A = +25^\circ\text{C}$ $T_A = 0^\circ$ to $+70^\circ\text{C}$ (MC34084, MC34085) $T_A = -55^\circ$ to $+125^\circ\text{C}$ (MC35084, MC35085)	V_{IO}	—	0.5	2.0	mV
Average Temperature Coefficient of Offset Voltage	$\Delta V_{IO}/\Delta T$	—	10	—	$\mu\text{V}/^\circ\text{C}$
Input Bias Current ($V_{CM} = 0$ Note 5) $T_A = +25^\circ\text{C}$ $T_A = 0^\circ$ to $+70^\circ\text{C}$ $T_A = -55^\circ$ to $+125^\circ\text{C}$	I_{IB}	—	0.06	0.2	nA
Input Offset Current ($V_{CM} = 0$ Note 5) $T_A = +25^\circ\text{C}$ $T_A = 0^\circ$ to $+70^\circ\text{C}$ $T_A = -55^\circ$ to $+125^\circ\text{C}$	I_{IO}	—	0.02	0.1	nA
Large Signal Voltage Gain ($V_O = \pm 10\text{ V}$, $R_L = 2.0\text{ k}$) $T_A = +25^\circ\text{C}$ $T_A = T_{\text{low}}$ to T_{high}	A_{VOL}	25	80	—	V/mV
Output Voltage Swing $R_L = 2.0\text{ k}$, $T_A = +25^\circ\text{C}$ $R_L = 10\text{ k}$, $T_A = +25^\circ\text{C}$ $R_L = 10\text{ k}$, $T_A = T_{\text{low}}$ to T_{high} $R_L = 2.0\text{ k}$, $T_A = +25^\circ\text{C}$ $R_L = 10\text{ k}$, $T_A = +25^\circ\text{C}$ $R_L = 10\text{ k}$, $T_A = T_{\text{low}}$ to T_{high}	V_{OH}	13.2	13.7	—	V
	V_{OL}	—	-14.1	-13.5	
Output Short Circuit Current ($T_A = +25^\circ\text{C}$) Input Overdrive = 1.0 V, Output to Ground Source Sink	I_{SC}	20	31	—	mA
Input Common Mode Voltage Range $T_A = +25^\circ\text{C}$	V_{ICR}	$(V_{EE} + 4.0)$ to $(V_{CC} - 2.0)$			V
Common Mode Rejection Ratio ($R_S \leq 10\text{ k}$, $T_A = +25^\circ\text{C}$)	CMRR	70	90	—	dB
Power Supply Rejection Ratio ($R_S = 100\ \Omega$, $T_A = 25^\circ\text{C}$)	PSRR	70	86	—	dB
Power Supply Current Single $T_A = +25^\circ\text{C}$ $T_A = T_{\text{low}}$ to T_{high} Dual $T_A = +25^\circ\text{C}$ $T_A = T_{\text{low}}$ to T_{high} Quad $T_A = +25^\circ\text{C}$ $T_A = T_{\text{low}}$ to T_{high}	I_D	—	2.5	3.4	mA
		—	—	4.2	
		—	4.9	6.0	
		—	—	7.5	
		—	9.7	11	
		—	—	13	

NOTES: (continued)

3. $T_{\text{low}} = -55^\circ\text{C}$ for MC35080B $T_{\text{low}} = 0^\circ\text{C}$ for MC34080B $T_{\text{high}} = +125^\circ\text{C}$ for MC35080B $T_{\text{high}} = +70^\circ\text{C}$ for MC34080B
 MC35081B MC34081B MC35081B MC34081B
 MC35084 MC34084 MC35084 MC34084
 MC35085 MC34085 MC35085 MC34085

4. See application information for typical changes in input offset voltage due to solderability and temperature cycling.

5. Limits at $T_A = +25^\circ\text{C}$ are guaranteed by high temperature (T_{high}) testing.

MC34080, MC35080 Series

AC ELECTRICAL CHARACTERISTICS ($V_{CC} = +15\text{ V}$, $V_{EE} = -15\text{ V}$, $T_A = +25^\circ\text{C}$, unless otherwise noted.)

Characteristics	Symbol	Min	Typ	Max	Unit
Slew Rate ($V_{in} = -10\text{ V}$ to $+10\text{ V}$, $R_L = 2.0\text{ k}\Omega$, $C_L = 100\text{ pF}$) Compensated $A_V = +1.0$ $A_V = -1.0$ Decompensated $A_V = +2.0$ $A_V = -1.0$	SR	20	25 30	— —	V/ μs
Settling Time (10 V Step, $A_V = -1.0$) To 0.10% ($\pm 1/2$ LSB of 9-Bits) To 0.01% ($\pm 1/2$ LSB of 12-Bits)	t_s	—	0.72 1.6	— —	μs
Gain Bandwidth Product ($f = 200\text{ kHz}$) Compensated Decompensated	GBW	6.0 12	8.0 16	— —	MHz
Power Bandwidth ($R_L = 2.0\text{ k}\Omega$, $V_O = 20\text{ V}_{p-p}$, THD = 5.0%) Compensated $A_V = +1.0$ Decompensated $A_V = -1.0$	BWp	— —	400 800	— —	kHz
Phase margin (Compensated) $R_L = 2.0\text{ k}\Omega$ $R_L = 2.0\text{ k}\Omega$, $C_L = 100\text{ pF}$	ϕ_m	— —	55 39	— —	Degrees
Gain Margin (Compensated) $R_L = 2.0\text{ k}\Omega$ $R_L = 2.0\text{ k}\Omega$, $C_L = 100\text{ pF}$	A_m	— —	7.6 4.5	— —	dB
Equivalent Input Noise Voltage $R_S = 100\ \Omega$, $f = 1.0\text{ kHz}$	e_n	—	30	—	nV/ $\sqrt{\text{Hz}}$
Equivalent Input Noise Current ($f = 1.0\text{ kHz}$)	i_n	—	0.01	—	pA/ $\sqrt{\text{Hz}}$
Input Capacitance	C_i	—	5.0	—	pF
Input Resistance	r_i	—	10^{12}	—	Ω
Total Harmonic Distortion $A_V = +10$, $R_L = 2.0\text{ k}\Omega$, $2.0 \leq V_O \leq 20\text{ V}_{p-p}$, $f = 10\text{ kHz}$	THD	—	0.05	—	%
Channel Separation ($f = 10\text{ kHz}$)	—	—	120	—	dB
Open-Loop Output Impedance ($f = 1.0\text{ MHz}$)	Z_o	—	35	—	Ω

2

Figure 1. Input Common Mode Voltage Range versus Temperature

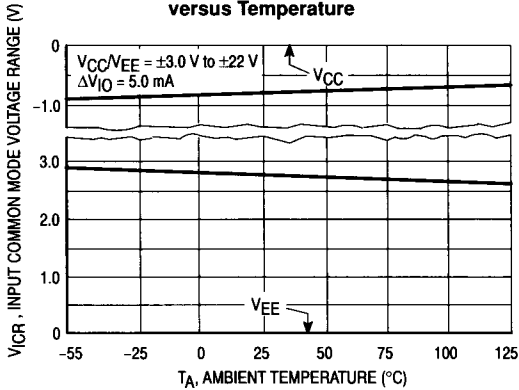
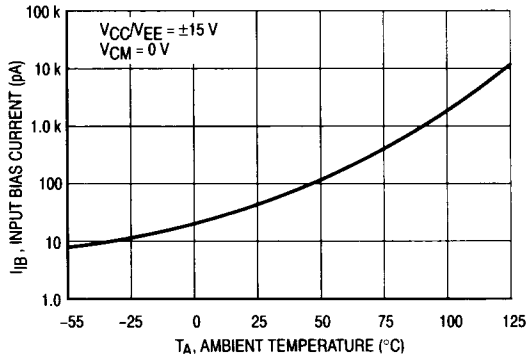

Figure 2. Input Bias Current versus Temperature



MC34080, MC35080 Series

2

Figure 3. Input Bias Current versus Input Common Mode Voltage

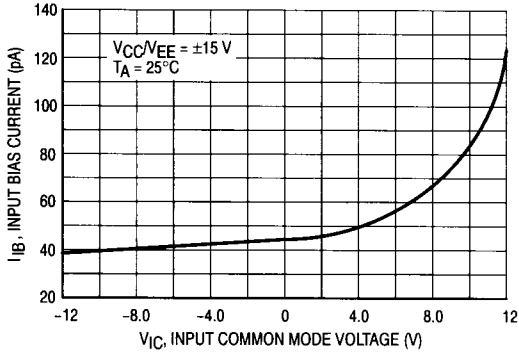

Figure 4. Output Voltage Swing versus Supply Voltage

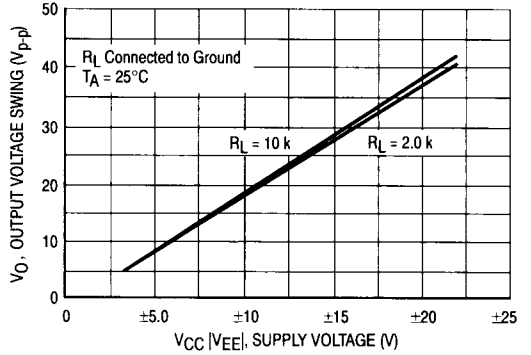

Figure 5. Output Saturation versus Load Current

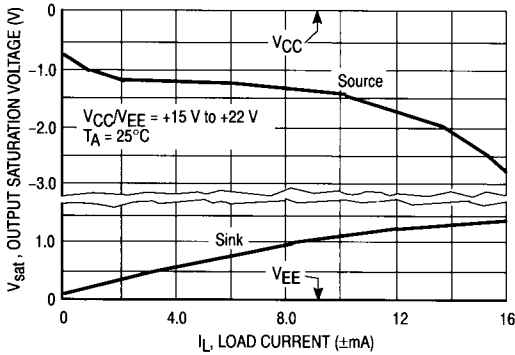

Figure 6. Output Saturation versus Load Resistance to Ground

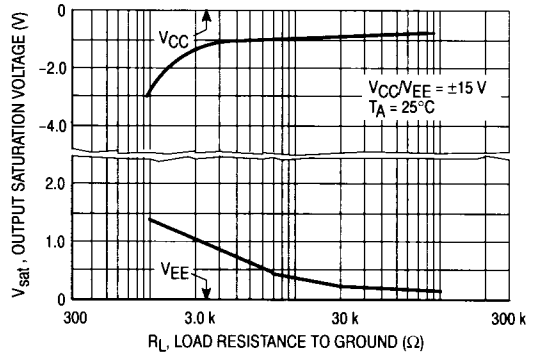

Figure 7. Output Saturation versus Load Resistance to V_{CC}

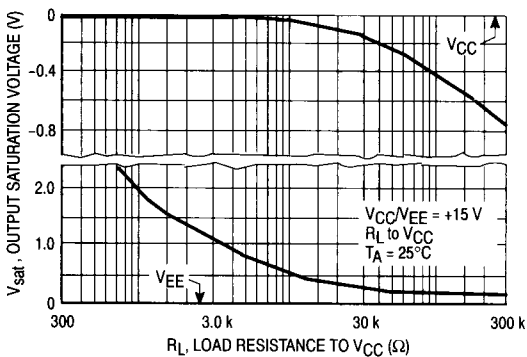
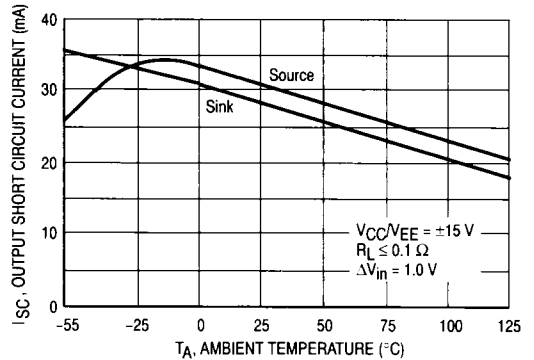

Figure 8. Output Short Circuit Current versus Temperature



MC34080, MC35080 Series

Figure 9. Output Impedance versus Frequency

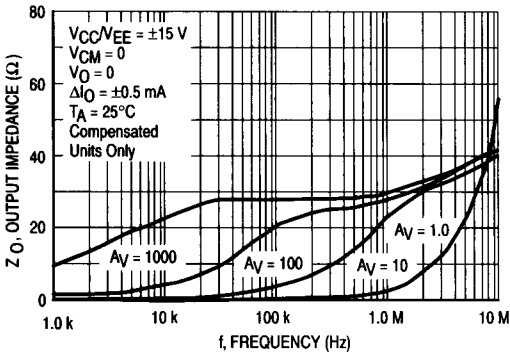

Figure 10. Output Impedance versus Frequency

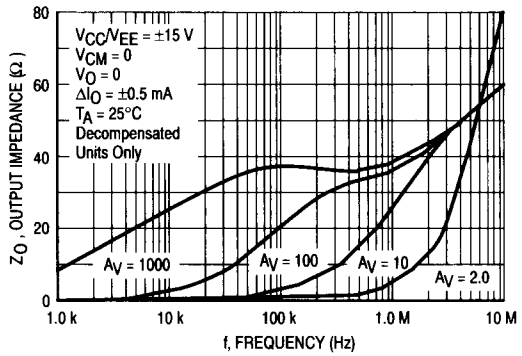

Figure 11. Output Voltage Swing versus Frequency

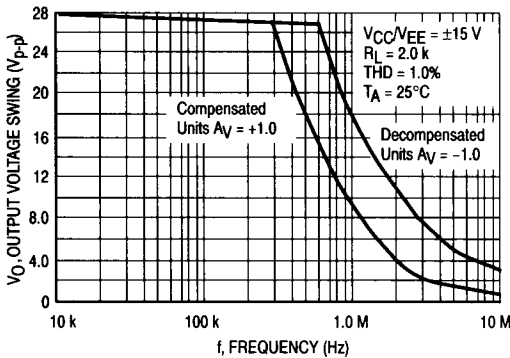

Figure 12. Output Distortion versus Frequency

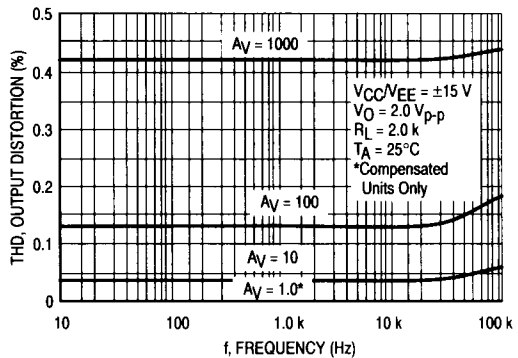

Figure 13. Open-Loop Voltage Gain versus Temperature

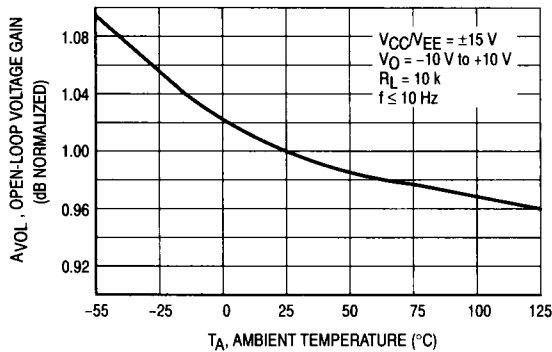

Figure 14. Open-Loop Voltage Gain and Phase versus Frequency

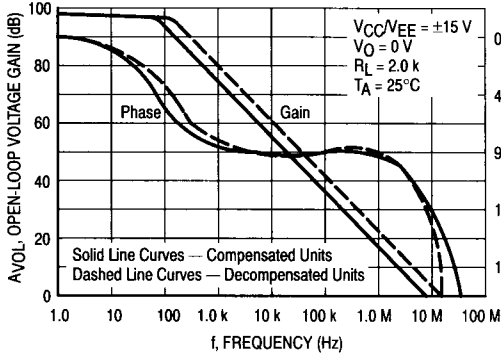

Figure 15. Open-Loop Voltage Gain and Phase versus Frequency

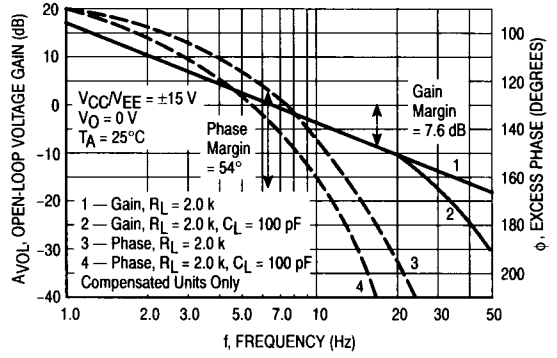

Figure 16. Open-Loop Voltage Gain and Phase versus Frequency

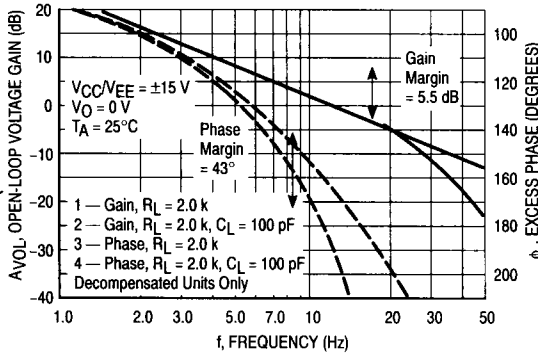

Figure 17. Normalized Gain Bandwidth Product versus Temperature

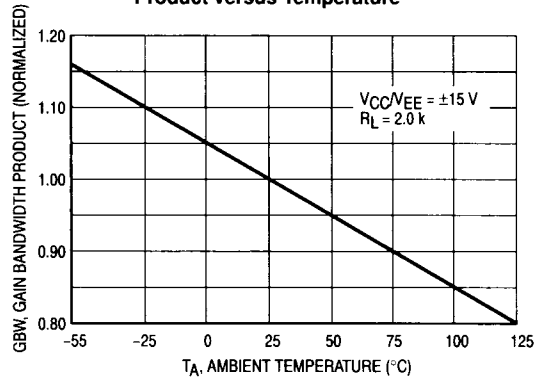

Figure 18. Percent Overshoot versus Load Capacitance

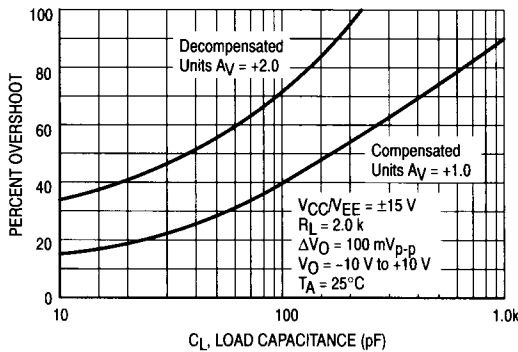
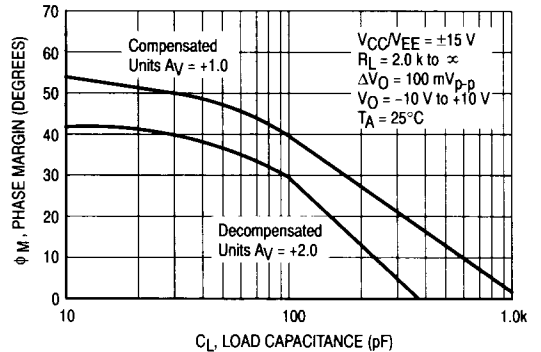

Figure 19. Phase Margin versus Load Capacitance



MC34080, MC35080 Series

Figure 20. Gain Margin versus Load Capacitance

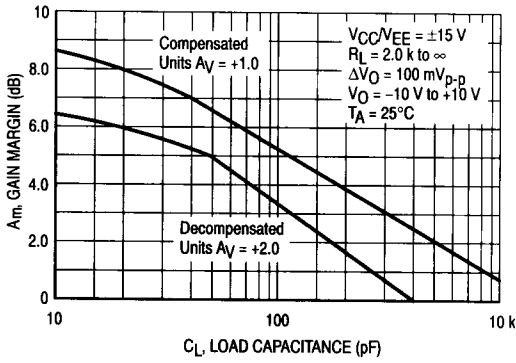

Figure 21. Phase Margin versus Temperature

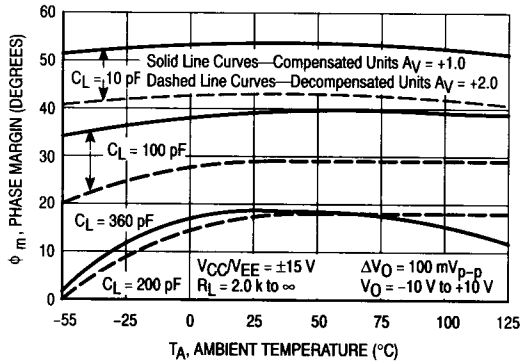

Figure 22. Gain Margin versus Temperature

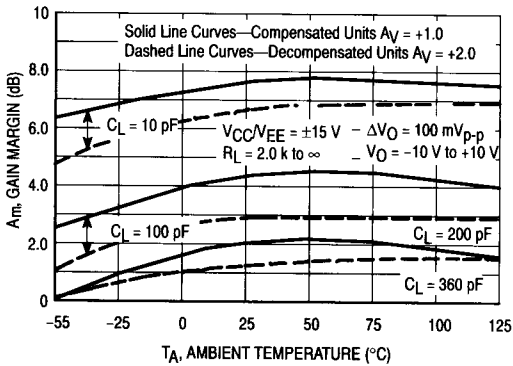
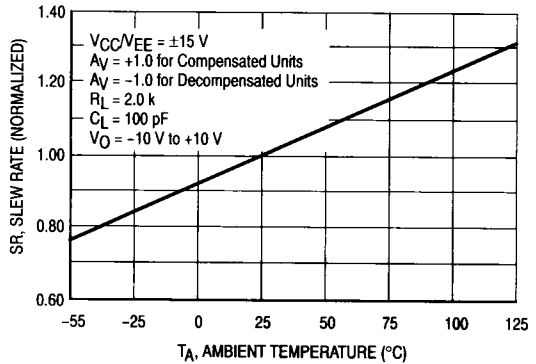

Figure 23. Normalized Slew Rate versus Temperature



MC34080, MC35080 Series

MC34084 Transient Response
 $A_V = +1.0$, $R_L = 2.0 \text{ k}$, $V_{CC}/V_{EE} = \pm 15 \text{ V}$, $T_A = 25^\circ\text{C}$

2

Figure 24. Small-Signal

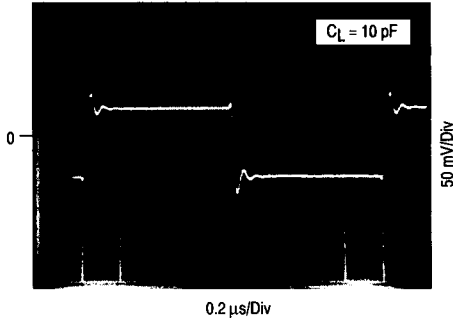
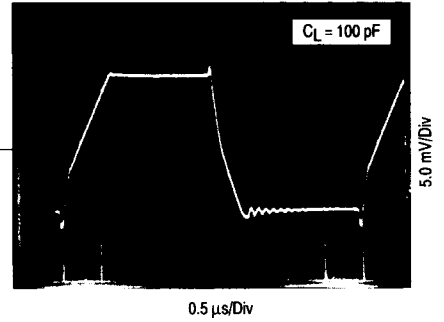

Figure 25. Large-Signal



MC34085 Transient Response
 $A_V = +2.0$, $R_L = 2.0 \text{ k}$, $V_{CC}/V_{EE} = \pm 15 \text{ V}$, $T_A = 25^\circ\text{C}$

Figure 26. Small-Signal

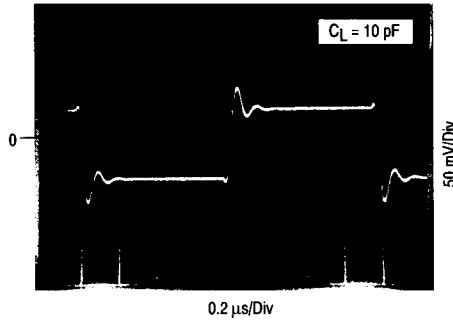
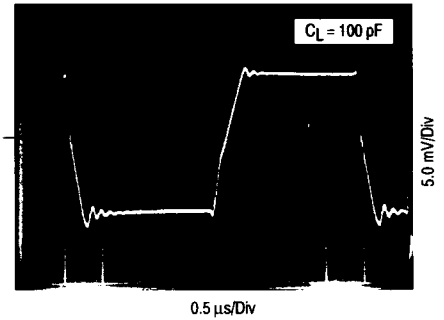

Figure 27. Large-Signal



MC34080, MC35080 Series

Figure 28. Common Mode Rejection Ratio versus Frequency

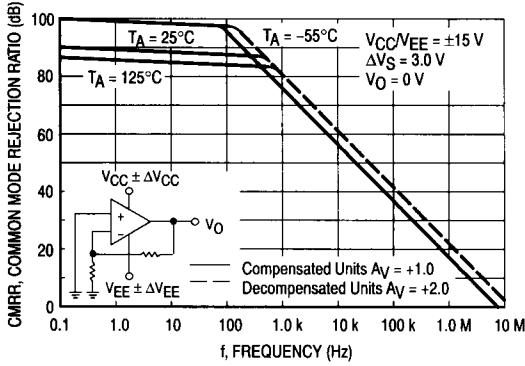

Figure 29. Power Supply Rejection Ratio versus Frequency

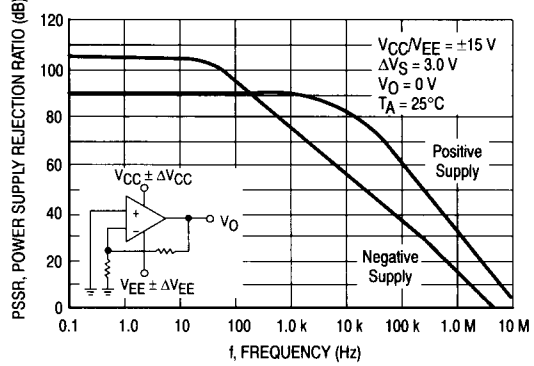

Figure 30. Power Supply Rejection Ratio versus Temperature

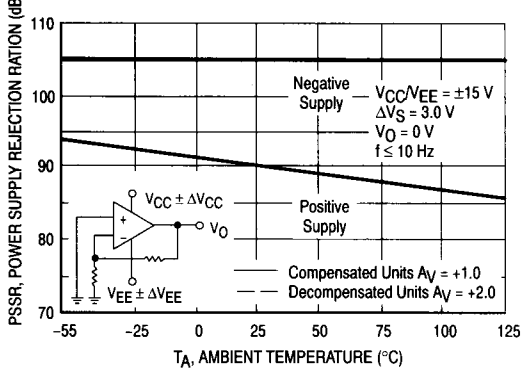

Figure 32. Normalized Supply Current versus Supply Voltage

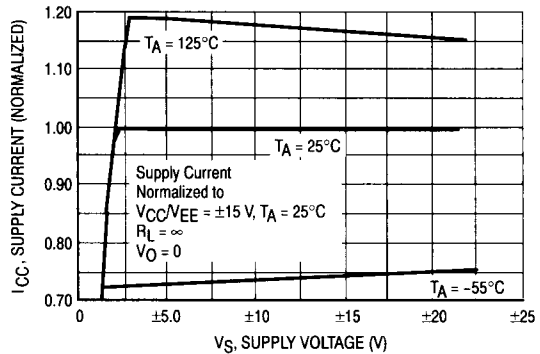

Figure 32. Channel Separation versus Frequency

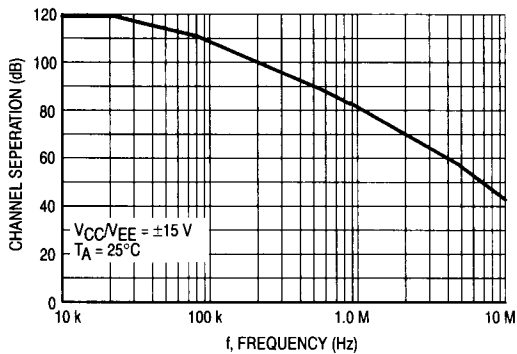
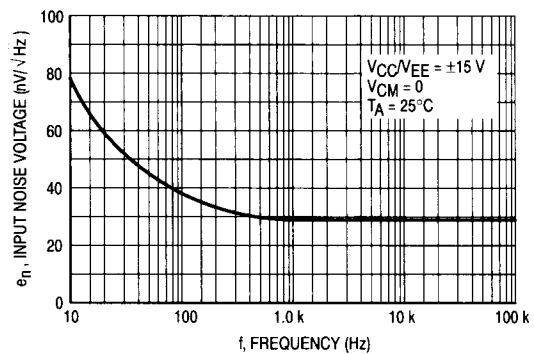

Figure 33. Spectral Noise Density



MC34080, MC35080 Series

APPLICATIONS INFORMATION

2

The bandwidth and slew rate of the MC34080 series is nearly double that of currently available general purpose JFET op-amps. This improvement in AC performance is due to the P-channel JFET differential input stage driving a compensated miller integration amplifier in conjunction with an all NPN output stage.

The all NPN output stage offers unique advantages over the more conventional NPN/PNP transistor Class AB output stage. With a 10 k load resistance, the op amp can typically swing within 1.0 V of the positive rail (V_{CC}), and within 0.3 V of the negative rail (V_{EE}), providing a 28.7 p-p swing from ± 15 V supplies. This large output swing becomes most noticeable at lower supply voltages. If the load resistance is referenced to V_{CC} instead of ground, the maximum possible output swing can be achieved for a given supply voltage. For light load currents, the load resistance will pull the output to V_{CC} during the positive swing and the NPN output transistor will pull the output very near V_{EE} during the negative swing. The load resistance value should be much less than that of the feedback resistance to maximize pull-up capability.

The all NPN transistor output stage is also inherently fast, contributing to the operation amplifier's high gain-bandwidth product and fast settling time. The associated high frequency output impedance is 50 Ω (typical) at 8.0 MHz. This allows driving capacitive loads from 0 pF to 300 pF without oscillations over the military temperature range, and over the full range of output swing. The 55°C phase margin and 7.6 dB gain margin as well as the general gain and phase characteristics are virtually independent of the sink/source output swing conditions. The high frequency characteristics of the MC34080 series is especially useful for active filter applications.

The common mode input range is from 2.0 V below the positive rail (V_{CC}) to 4.0 V above the negative rail (V_{EE}). The amplifier remains active if the inputs are biased at the positive rail. This may be useful for some applications in that single supply operation is possible with a single negative supply. However, a degradation of offset voltage and voltage gain may result.

Phase reversal does not occur if either the inverting or noninverting input (or both) exceeds the positive common mode limit. If either input (or both) exceeds the negative common mode limit, the output will be in the high state. The

input stage also allows a differential up to ± 44 V, provided the maximum input voltage range is not exceeded. The supply voltage operating range is from ± 5.0 V to ± 22 V.

For optimum frequency performance and stability careful component placement and printed circuit board layout should be exercised. For example, long unshielded input or output leads may result in unwanted input-output coupling. In order to reduce the input capacitance, resistors connected to the input pins should be physically close to these pins. This not only minimizes the input pole for optimum frequency response, but also minimizes extraneous "pickup" at this node.

Supply decoupling with adequate capacitance close to the supply pin is also important, particularly over temperature, since many types of decoupling capacitors exhibit large impedance changes over temperature.

Primarily due to the JFET inputs of the op amp, the input offset voltage may change due to temperature cycling and board soldering. After 20 temperature cycles (-55° to 165°C), the typical standard deviation for input offset voltage is 559 μV and 473 μV in the plastic and ceramic packages respectively. With respect to board soldering (260°C, 10 seconds) the typical standard deviation for input offset voltage is 525 μV and 227 μV in the plastic and ceramic package respectively. Socketed plastic or ceramic packaged devices should be used over a minimal temperature range for optimum input offset voltage performance.

Figure 34. Offset Nulling Circuit

