

Silicon Diodes



DT-470 and DT-471 Features and Description

DT-470 Features

- Advanced, hermetic ceramic and sapphire packaging with the lowest self-heating errors.
- Monotonic temperature response over its useful range from 1.4 K to 475 K.
- All sensors follow a standard temperature response curve (Curve 10).
- Available in five tolerance bands to Curve 10.
- Repeatability at 4.2 K typically ± 10 mK over repeated thermal cycling.
- High sensitivity at low temperature for critical low temperature measurements.
- Accommodates a variety of mounting adaptors and probe assemblies.
- Useful above 60 K in magnetic fields up to 5 tesla.
- SoftCal™ calibration available.

DT-471 Features

- Temperature range: 10 K to 475 K.
- Follows Curve 10 from 10 K to 475 K.
- Accuracy: ± 1.5 K or $\pm 1.5\%$ of temperature reading, whichever is greater.
- Shares other benefits with the DT-470.
 - Repeatability
 - Sensitivity
 - Mounting
 - B dependence
- SoftCal™ calibration available.

Interchangeable – The DT-470/471 silicon diode temperature sensors incorporate remarkably uniform sensing elements that exhibit precise, repeatable, monotonic temperature response over a wide range. The elements are mounted into rugged, hermetically-sealed packages that have been specifically designed for proper thermal behavior in a cryogenic environment. The result is a family of sensors with temperature characteristics so predictable, tightly grouped and stable, that the sensors in most applications can be routinely interchanged with one another.

Repeatable – The small silicon chip in each sensor has a temperature characteristic that is extremely stable and predictable. The –SD sensor package is designed to withstand repeated cycling to low temperatures without mechanical failure. Repeatability at 4.2 K over repeated thermal cycling from room temperature to helium temperature is typically ± 10 mK or better. Repeatability from 1.4 K to 330 K is typically better than ± 20 mK. For long term stability, see the specifications.

Accurate – All DT-470/471 silicon diodes follow a standard temperature response curve, Curve 10 (See the Reference Section). For the DT-470 diodes, five tolerance bands are offered to allow sensor selection that will meet both technical and economic requirements. Within these five bands, low temperature accuracies of ± 0.25 K, ± 0.5 K and ± 1 K are available. For the DT-471 diodes, accuracy is ± 1.5 K or $\pm 1\ 1/2\%$ of temperature reading, whichever is greater, from 10 K to 475 K. For more demanding requirements, DT-470/DT-471 diodes can be used with SoftCal™ or these sensors can be calibrated to accuracies of ± 50 mK or better.



The DT-471 silicon diode sensors offer an inexpensive alternative for situations in which temperature measurement below 10 K is not necessary and a tolerance band wider than Band 13 is acceptable. The upper operating temperature is 475 K for the Model DT-471-SD, and to 325 K with an applicable mounting adapter. Because the DT-471 package/mounting adapter configurations are identical to those for the DT-470 diodes, installation and operation procedures are identical.

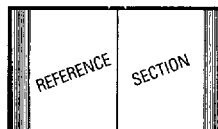

What is SoftCal™?

SoftCal is a 2-point or 3-point calibration which offers improved accuracy without the cost of a full calibration. SoftCal is available for silicon diodes, Carbon-Glass™, and platinum sensors.

For detailed information on SoftCal™, CalCurve, and Curve 10, see the Reference Section.



As can be seen from the adjoining table, magnetic field induced temperature errors are strongly orientation dependent. To minimize this effect, the sensor should be orientated so that the package base is perpendicular to the magnetic field flux lines; this results in the diode current being parallel to the magnetic field.

Typical Magnetic Field-Dependent Temperature Errors $\Delta T/T$ (%) at B (magnetic induction) for Silicon Diodes						
Package Base Parallel to Field B (tesla)						
T(K)	1	2	3	4	5	
4.2	-200	-300	-350	-400	-500	
20	-10	-20	-25	-30	-40	
40	-4	-6	-8	-10	-12	
60	-0.5	-1	-2	-3	-3.5	
80	< 0.1	-0.5	-0.8	-1.1	-1.5	
300	< -0.1	< -0.1	< -0.1	< -0.1	< -0.1	
Package Base Perpendicular to Field B (tesla)						
T(K)	1	2	3	4	5	
4.2	-8	-9	-11	-15	-20	
20	-4	-5	-5	-5	-10	
40	-1.5	-3	-4	-5	-5.5	
60	-0.5	-0.7	-0.8	-1	-1.1	
80	-0.1	-0.3	-0.5	-0.6	-0.7	
300	< 0.1	0.2	0.5	0.6	0.6	

5335450 0000883 034

DT-414, DT-420 and DT-450 Features and Description

DT-414 Features

- Temperature range: 1.4 K to 375 K.
- Small mass for rapid thermal response.
- Incorporates non-magnetic materials.

DT-414 Unencapsulated Silicon Diodes

The Model DT-414 uses the silicon diode chip used in the DT-470s. It is mounted on a flat substrate. This chip-level sensor offers minimal thermal mass and minimal physical size. Die attachment is with silver epoxy. The chip is not encapsulated, leaving the fragile gold wires exposed.

The DT-414 is supplied in a Gel-Pak™ with 0.5" to 1" long, 50 μm diameter gold leads. If it is desired to wirebond the chip into a circuit using the user's wire, the gold ball bonds can be removed using a sharp blade. This will leave more room for attachment of new gold or aluminum wire. The leads (as supplied) can also be thermo-compression bonded or soldered at their free ends.

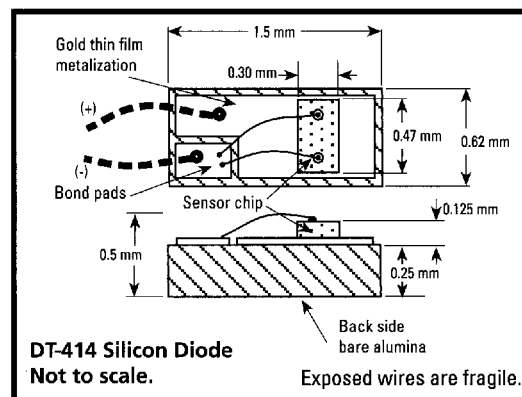

DT-420 Features

- Temperature range: 1.4 K to 325 K.
- Repeatability (at 4.2 K) typically ±50 mK over repeated thermal cycling.
- Exposed flat substrate for surface mounting.
- Incorporates non-magnetic materials.
- Small mass for rapid thermal response.

DT-420 Miniature Silicon Diode

The DT-420 subminiature silicon diode temperature sensor is configured for installation on flat surfaces. The DT-420 sensor package exhibits precise, monotonic temperature response over its useful range, and is designed to withstand repeated cycling to low temperatures without mechanical failure. The sensor chip is in direct contact with the epoxy dome, which causes increased voltage at 4.2 K and prevents full range conformity to the Curve 10. The anode lead is electrically connected to the platinum base, and should be isolated by the user for installation on metallic surfaces (see Reference Section).

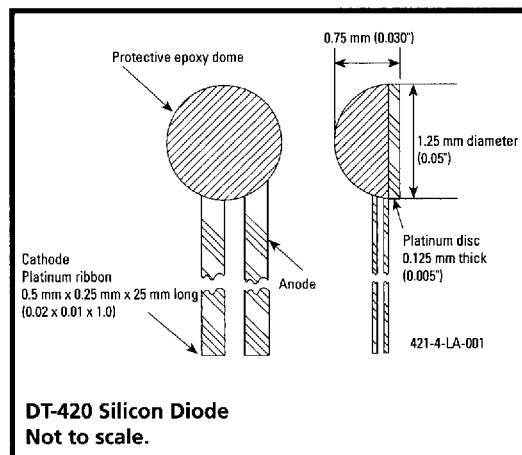

DT-450 Features

- Temperature range: 1.4 K to 325 K.
- Can be inserted into a hole only 1.6 mm (1/16") diameter by 3.2 mm (1/8") deep.
- Follows Curve 10.
- Repeatability (at 4.2 K) typically ±50 mK over repeated thermal cycling.
- Incorporates magnetic materials.

DT-450 Miniature Silicon Diode

The DT-450 miniature silicon diode temperature sensor is configured for installation in recesses as small as 1.6 mm diameter by 3.2 mm deep. The sensor incorporates the same type of silicon chip that is used in the DT-470 and sensor. The DT-450 sensor package exhibits precise, monotonic temperature response over its useful range, and is designed to withstand repeated cycling to low temperature without mechanical failure. The silicon diode chip and internal wires are not in contact with the plastic dome. The substrate is sapphire brazed to a metal half-round base. The sensor chip is electrically isolated from the base.

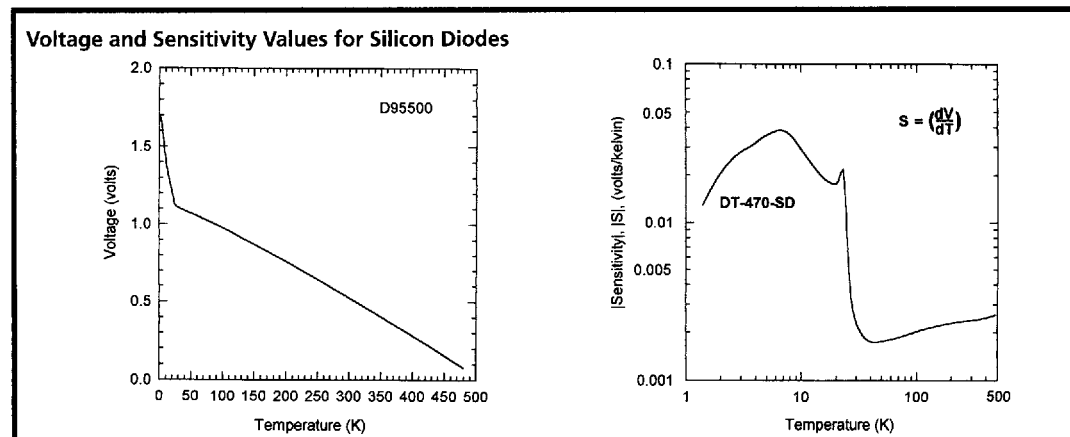
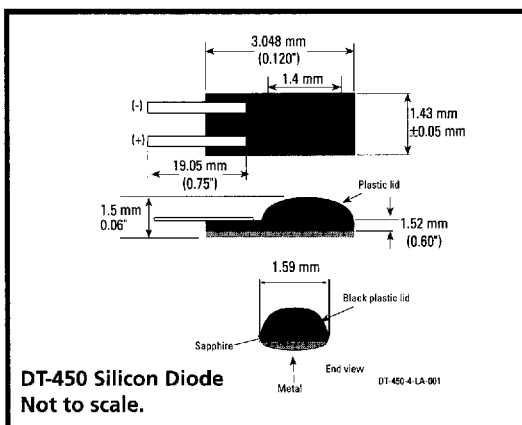

5335450 0000884 T70

Specifications

	DT-470-SD and DT-471-SD	DT-414
Temperature		
Useful range		
Minimum	1.4 K (10 K for the DT-471).	1.4 K.
Maximum	475 K.	375 K.
Maximum storage temperature	30 °C.	30 °C.
Standard curve	Curve 10 (5 tolerance bands for DT-470).	Curve 10
Sensitivity (typical)	-33.6 mV/K at 4.2 K (DT-470 only); -1.91 mV/K at 77 K; -2.41 mV/K at 305 K.	-33.6 mV/K at 4.2 K; -1.91 mV/K at 77 K; -2.41 mV/K at 305 K.
Repeatability (typically)	±10 mK or better at 4.2 K; ±20 mK (1.4 K to 330 K).	±10 mK or better at 4.2 K; ±20 mK (1.4 K to 330 K).
Accuracy (interchangeability)	Curve 10 (Band 11 to Band 13 for DT-470). ±1.5 K or ±1.5% whichever is greater (10 K to 475 K) (Model DT-471 only).	±1.5 K or ±1.5% whichever is greater.
Accuracy (SoftCal™)		
2 point (77 K and 305 K)	±0.25 K (30 K to 60 K) ±0.15 K (60 K to 345 K) ±0.25 K (345 K to 375 K) ±1.0 K (375 K to 475 K).	Not applicable.
3 point (DT-470 only) (4.2 K, 77 K and 305 K)	±0.5 K (2 K to 30 K) ±0.25 K (30 K to 60 K) ±0.15 K (60 K to 345 K) ±0.25 K (345 K to 375 K) ±1.0 K (375 K to 475 K).	Not applicable.
Accuracy (calibrated)	±20 mK < 10 K; ±50 mK (10 K to 330 K).	±20 mK < 10 K; 50 mK (10 K to 330 K).
Stability		
Short-term	±20 mK or better (1.4 K to 330 K) ±10 mK or better at 4.2 K.	±20 mK or better (1.4 K to 330 K).
Long-term (per year)	±10 mK/year at 4.2 K ±40 mK/year at 77 K ±25 mK/year at 300 K.	±10 mK/year at 4.2 K ±40 mK/year at 77 K ±25 mK/year at 300 K.
Thermal response time (-SD package)	Typical <10 milliseconds at 4.2 K; 100 milliseconds at 77 K; 200 milliseconds at 305 K (all models).	
Recommended recalibration schedule	Annual.	Annual.
Excitation		
Recommended	10 µA ±0.05%.	10 µA ±0.05%.
Maximum reverse voltage (diode)	40 VDC.	40 VDC.
Maximum forward current (diode)	500 µA continuous or 5 mA in <100 microsecond pulses (all models).	500 µA continuous or 5 mA in <100 microsecond pulses (all models).
Maximum current before damage	1 mA continuous.	1 mA continuous.
Dissipation at rated excitation	17 µW at 4.2 K; 10 µW at 77 K; 5 µW at 300 K.	17 µW at 4.2 K; 10 µW at 77 K; 5 µW at 300 K.
Units range	0 to 2 volts.	0 to 2 volts.
Lead wire configuration (polarity)	Positive lead on right with package lid up and leads towards user.	Positive lead on left with chip up and leads towards user.
Physical Specifications		
Materials in the sensor/construction	Sapphire base with alumina body and lid. Molybdenum/manganese metallization on base and lid top with nickel and gold plating. Gold-tin solder as hermetic lid seal. Silicon chip with aluminum metallization.	Alumina base, with metallization 0.1 µm of molybdenum, 0.2 µm gold.
Size	1 mm high x 1.9 mm wide x 3.2 mm long.	0.5 mm high x 0.63 mm wide x 1.52 mm dia.
Mass	37 milligrams.	3 milligrams.
Leads		
Size	0.38 mm x 0.1 mm thick x 12.7 mm long.	50 µm diameter x 2.54 mm long
Number	Two (2).	Two (2).
Material	Nickel and gold plated Kovar, uninsulated	Gold
Internal atmosphere	Package hermetically sealed.	Not applicable
Environmental		
Radiation effects	See Reference Section.	See Reference Section.
Magnetic fields	Not recommended for use in magnetic field applications used in fields up to 5 tesla above 60 K (all three models).	below 60 K. Low magnetic field dependence when used in fields up to 5 tesla above 60 K (all three models).
Vacuum vs. liquid differences at ≤4.2 K	Typically 5 mK to 35 mK depending on configuration. See application note "Self-heating Temperature Errors in Silicon Diode Temperature Sensors" in the Reference Section (both models).	
ESD sensitivity	3000 static volts	3000 static volts
Noise sensitivity	Can be significant ⁽¹⁾ .	Can be significant ⁽¹⁾ .



Specification Table Key

Blue shade	Specification different for at least one model
White shade	Specifications are the same for all models.
Gray shade	Specifications are the same for all models.



(1) See the application note titled "Measurement system induced errors in diode thermometry", Rev. Sci. Instrum. 57 (4), April 1986. Lake Shore order number 1420. Also see the Reference Section.

5335450 0000885 907

Specifications

DT-420

DT-450

Temperature

Useful range	1.4 K (must be calibrated below 40 K). 325 K.	1.4 K. 325 K.
Minimum	325 K.	325 K.
Maximum	30 °C.	30 °C.
Maximum storage temperature	DT-421/DT-422 follows Curve 10 to a tolerance of 2.0 K or 1.5% of temperature from 10 K to 325 K, whichever is greater.	Follows Curve 10 Band 13 to an upper limit of 325 K.
Standard curve		
Sensitivity (typical)	-36 mV/K at 4.2 K; -2 mV/K at 100 K; -2.4 mV/K at 305 K.	-36 mV/K at 4.2 K; -2 mV/K at 77 K; -2.4 mV/K at 305 K.
Repeatability	Repeatability at 4.2 K is required to be better than ± 50 mK over three thermal cycles for device acceptance. Repeatability is typically better than ± 10 mK (both models).	
Accuracy (interchangeability)	± 1 K from 40 K to 100 K; $\pm 1\%$ of temperature from 100 K to 325 K.	Band 13.
Accuracy (SoftCal™)	2 point: ± 0.25 K (30 K to 60 K) ± 0.15 K (60 K to 325 K).	2 point: ± 0.25 K (30 K to 60 K) ± 0.15 K (60 K to 325 K) 3 point: 0.5 K (2 K to 30 K) ± 0.25 K (30 K to 60 K) ± 0.15 K (60 K to 325 K).
Accuracy (calibrated)	± 50 mK or better.	± 50 mK or better.
Stability		
Short-term	± 25 mK at 4.2 K.	± 25 mK at 4.2 K.
Long-term (per year)	± 10 mK/year at 4.2 K ± 40 mK/year at 77 K ± 25 mK/year at 300 K.	± 10 mK/year at 4.2 K ± 40 mK/year at 77 K ± 25 mK/year at 300 K.
Thermal response time	<10 milliseconds at 4.2 K; 100 milliseconds at 77 K; 200 milliseconds at 305 K (both models).	
Recommended recalibration schedule	Annual.	Annual.

Excitation

Recommended	10 μ A $\pm 0.05\%$.	10 μ A $\pm 0.05\%$.
Maximum reverse voltage (diode)	40 VDC.	40 VDC.
Maximum forward current (diode)	500 μ A continuous or 5 mA in <100 microsecond pulses (both models).	
Maximum power before damage	2 mW continuous.	2 mW.
Dissipation at rated excitation	17 μ W at 4.2 K; 10 μ W at 77 K, 5 μ W at 300 K.	17 μ W at 4.2 K; 10 μ W at 77 K; 5 μ W at 300 K.
Units range	0 to 2 volts.	0 to 2 volts.
Lead wire configuration	Positive lead is right-hand ribbon with the platinum disk down and the leads towards the user.	Positive lead on right with package lid up and leads towards user.

Physical Specifications

Materials in the sensor/construction	The sensing element is mounted to a platinum disk and covered with a dome of Stycast™ epoxy.	The sensing element is mounted to a sapphire substrate, which in turn is brazed to a gold-plated, metallic base with half the thermal conductivity of copper. A plastic lid is placed over the device and sealed with epoxy to provide a non-hermetic cavity surrounding the sensor chip. No epoxy comes into contact with the chip.
Size in millimeters	<1 mm high x 1.25 mm diameter.	3.18 mm long x 1.58 mm diameter.
Mass	23 milligrams.	28 milligrams.
Leads		
Size	0.5 mm x 0.25 mm x 25 mm long.	0.25 mm x 0.10 mm x 12.7 mm long.
Number	Two (2).	Two (2).
Material	Platinum ribbon with ends tinned with 60/40 PbSn solder.	Nickel and gold plated Kovar.

Environmental

Radiation effects (temperature shift [mK])	See Reference Section.	See Reference Section.
Magnetic fields	Not recommended for use in magnetic field applications below 60 K. Low magnetic field dependence when used in fields up to 5 tesla above 60 K (both models).	
Vacuum vs. liquid differences	<100 mK at 4.2 K typical greased to copper block in vacuum.	50 mK or less at 4.2 K typical, inserted into a copper block in grease in vacuum.
ESD sensitivity	3000 static volts.	3000 static volts.
Noise sensitivity	Can be significant ⁽¹⁾ .	Can be significant ⁽¹⁾ .

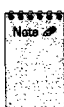

(1) See the application note titled "Measurement system induced errors in diode thermometry", Rev. Sci. Instrum. 57 (4), April 1986. Lake Shore order number 1420. Also see the Reference Section.

5335450 0000886 843

Silicon Diode Packages for Sensor Installation

-SD Package

The -SD configuration is the heart of the Lake Shore Cryotronics DT-470 sensors. It is designed primarily for bonding or clamping to a flat surface. Since the sensing element is in the best thermal contact with the base (largest surface) of the package, the package should be mounted with that same surface in good contact with the sample. Mounting materials and methods which will not expose the sensor to temperatures above 200 °C are required. Low temperature indium-silver solder or Stycast epoxy is recommended for most applications.

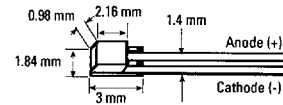

Leads (mm): 0.38 W x 0.10 T x =19 L
Sensor Mass: 0.03 g

Temperature range: 1.4 K to 475 K.

-CO Package

A spring-loaded clamp holds a standard -SD sensor in contact with the surface of the sample in this configuration. This allows the sensor to be easily changed or replaced. It also enables the sensor to be used over its full operational temperature range of 1.4 K to 475 K. Extra clamps (part number SN-CO-C1) are available to accommodate applications where frequent relocation of the sensor is desirable. The 4-40 stainless steel screw used with this clamp has a formed shoulder so that, once the screw is properly seated, the spring applies correct pressure to the clamp. For use below 4 K, good infrared radiation shielding should be provided.

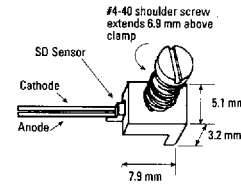

Leads (mm): 0.38 W x 0.1 T x =19 L
Mass: 1.7 g (without SD Sensor)

Temperature range: 1.4 K to 475 K.

-ET Package

This convenient screw-in package is formed at Lake Shore by soldering a basic -SD configuration into a recess in one flat of the hexagonal screwhead. The head terminates in a standard SAE 6-32 threaded stud. Thus, the sensor can be threaded (finger-tight only) into a mounting hole in the sample. A light coating of vacuum grease on the threads further enhances the thermal contact between the sensor package and the sample.

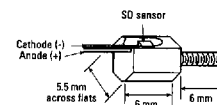

#6-32 threaded stud
Leads (mm): 0.38 W x 0.1 T x =19 L
Sensor Mass: 1.4 g

Temperature range: 1.4 K to 325 K.

-MT Package

The MT package is similar to the -ET version above except the -SD package is mounted in a slot in the center of the hexagonal head and the stud is a 3 mm x 0.5 metric thread.

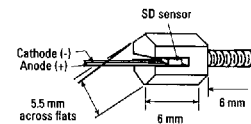

M3 x 0.5 pitch threaded stud
Leads (mm): 0.38 W x 0.1 T x =19 L
Sensor Mass: 1.4 g

Temperature range: 1.4 K to 325 K.

-CU Package

In this configuration, the -SD sensor is epoxied into a flat, cylindrical disk and the sensor leads are thermally anchored to that same disk. The unit can be mounted to any flat surface with a 4-40 brass screw (not supplied). The -CU package is wired in a four-lead configuration with the leads comprised of a 36-inch length of Lake Shore's highly versatile, 36-gauge, color-coded, QUAD-LEAD™ cryogenic wire.

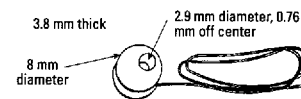

Leads: 914 mm (36") long, 36 AWG
Mass: 1 g (excluding leads)

Temperature range: 1.4 K to 325 K.

-DI Package

This is a two-lead version of the above sensor configuration designed to be the replacement for Lake Shore DT-500DI-8 sensors.

-LR Package

With an -SD sensor mounted on a slightly-more-than-half-rounded cylinder, this package is designed to be inserted into a 3.2 mm (1/8 inch) diameter hole. Thermal contact with the surrounding surface is enhanced by applying a coating of vacuum grease to the sensor. Stycast epoxy can also be used to install the sensor, although the mounting is very difficult or impossible to remove.

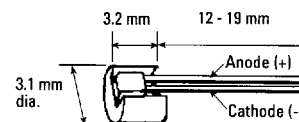

Leads (mm): 0.38 W x 0.1 T x =19 L
Mass: 0.15 g

Temperature range: 1.4 K to 325 K.

5335450 0000887 7&T

-CY Package

Some applications are best served by a relatively large-sized, robust sensor and the -CY fills that bill. It is very similar to the -CU package except the disk has a larger diameter with the mounting hole directly in the center. The -CY package is a two-lead design with 36-inch heavy duty (30 AWG, teflon-coated) leads. Special attention must be paid to thermally anchoring the leads to prevent heat leak-induced measurement error.

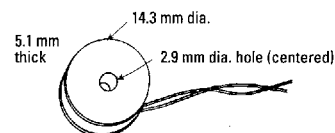

Leads: 914 mm (36 inch) long, 30 AWG stranded copper
Mass: 4.3 g (excluding leads)

Temperature range: 1.4 K to 325 K.

-BO and -BR Packages

In addition to being soldered to the mounting block, the -SD package in this design has its leads thermally anchored (without epoxy) to the block via a beryllium-oxide insert. Since leads can be a significant heat path to the sensing element, and can lead to measurement errors when incorrectly anchored, this configuration helps maintain the leads at the same temperature as the sensor. Mounting of this block is accomplished with a 4-40 screw (not supplied). The -BR version has 36 inch, QL-36 wire attached with epoxy strain relief over the beryllium-oxide insert.*

*The customer can provide this strain relief also. Do not get epoxy on the sensor.

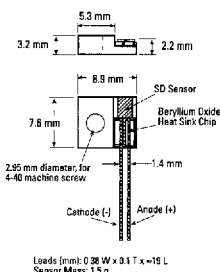

Leads (mm): 0.36 W x 0.17 x =19 L
Sensor Mass: 1.5 g

Temperature range: 1.4 K to 325 K.
Thickness: 0.125".

Adding Length to Sensor Leads

Adding extra wire to your sensor leads can be cumbersome and expensive. Lake Shore offers this service for you at the time of ordering your sensor. Following are the part numbers and lengths of wire available. Please specify two or four wire configurations at the time of order. A four wire configuration is recommended for resistors. Sensors with a -BG package do not accommodate lead lengthening.

SMOD-L-YYZZ-X

SMOD	Sensor modification
L	Number of leads
YY	Wire type
ZZ	Wire gauge
X	Length of wire

Wire lengths (X): 1, 2, 4, 6, 8, 10 and 15 feet.

Two wire configurations (L = 2)

SMOD-2-DT36-(X)	Two lead, Duo-Twist™ wire, 36 AWG
SMOD-2-MW30-(X)	Two lead, Manganin wire, 30 AWG
SMOD-2-MW32-(X)	Two lead, Manganin wire, 32 AWG
SMOD-2-MW36-(X)	Two lead, Manganin wire, 36 AWG
SMOD-2-NM32-(X)	Two lead, Non-magnetic wire, 32 AWG
SMOD-2-NM36-(X)	Two lead, Non-magnetic wire, 36 AWG
SMOD-2-NM42-(X)	Two lead, Non-magnetic wire, 42 AWG

Four wire configurations (L = 4)

SMOD-4-DT36-(X)	Four lead, Duo-Twist wire, 36 AWG
SMOD-4-MW30-(X)	Four lead, Manganin wire, 30 AWG
SMOD-4-MW32-(X)	Four lead, Manganin wire, 32 AWG
SMOD-4-MW36-(X)	Four lead, Manganin wire, 36 AWG
SMOD-4-NM32-(X)	Four lead, Non-magnetic wire, 32 AWG
SMOD-4-NM36-(X)	Four lead, Non-magnetic wire, 36 AWG
SMOD-4-NM42-(X)	Four lead, Non-magnetic wire, 42 AWG
SMOD-4-QL32-(X)	Four lead, Quad-Lead™ wire, 32 AWG
SMOD-4-QL36-(X)	Four lead, Quad-Lead™ wire, 36 AWG
SMOD-4-QT32-(X)	Four lead, Quad-Twist™ wire, 32 AWG

Coaxial

SMOD-2-S1-(X)	Two lead, type S1 coaxial cable
SMOD-4-S1-(X)	Four lead, type S1 coaxial cable

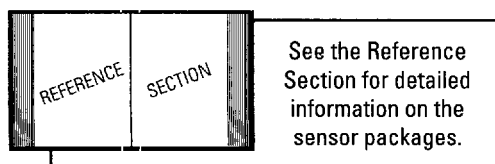

5335450 0000888 616

Standard Probes for Silicon Diodes

The flexibility of the Lake Shore DT-400 series silicon diodes make them ideal candidates for incorporating into various probes and thermowells. The individualized nature of applications usually demand customized designs. Lake Shore offers a wide variety of probes for about any application. Following are configurations of probes that can be purchased from Lake Shore. If you don't find a design that fits your application, please call us and let our engineers assist you in a customizing a probe for your application.

Probe Mounts

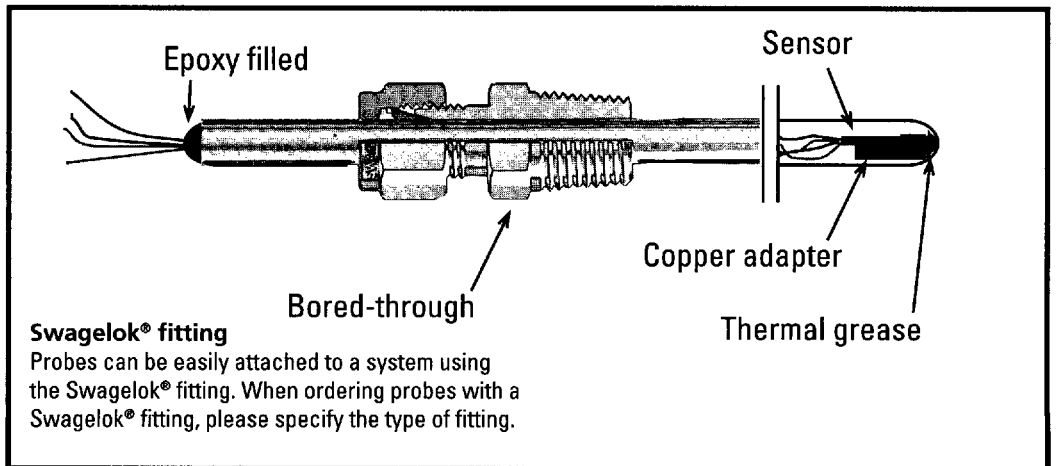
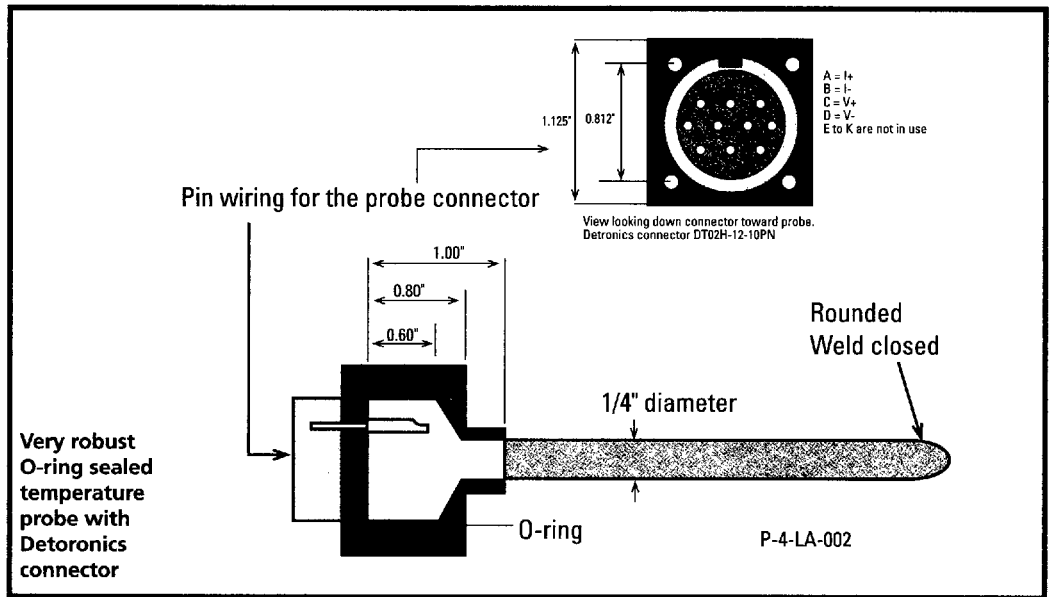
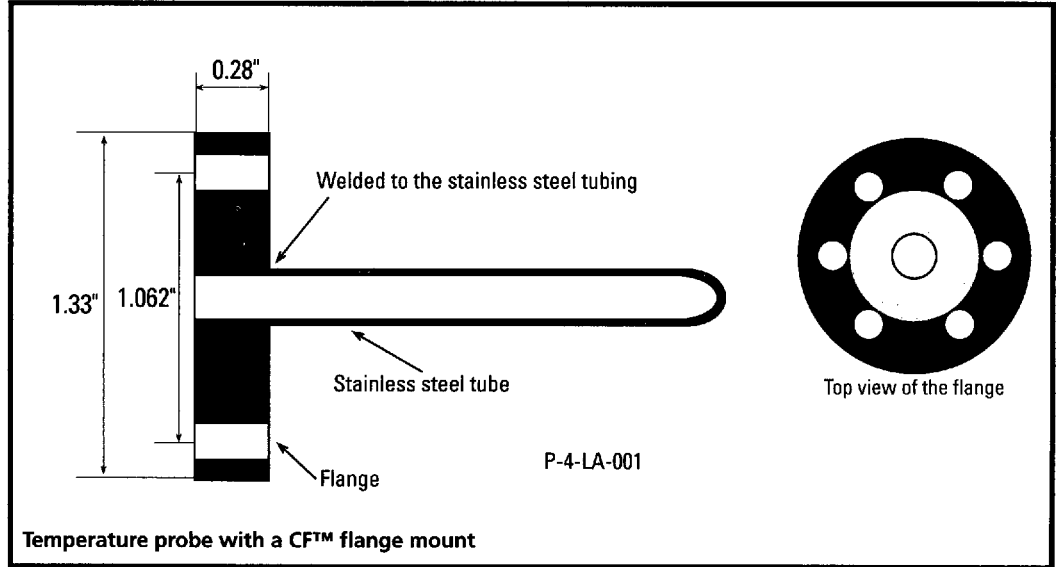

5335450 0000889 552

Probe information Cable information Sensor

TP – XYZ – ABC – DDD

Probe information

XX is the probe length

01 = 3/4 inch
 04 = 4 inches
 06 = 6 inches
 12 = 12 inches
 22 = 22 inches
 28 = 28 inches

Y is the probe diameter

2 = 1/8 inch
 4 = 1/4 inch

Z is the probe mount

N = No probe mount adapter
 S = Swagelok® fitting*
 F = Flange
 D = Detronics hermetic connector
 (1/4" tubing only)

Cable information

A is the cable/wire type

N = No cable type
 S = S1 coax cable
 I = 30 AWG instrument cable
 T = Duo-Twist wire, 32 AWG,
 DT-32

B is the cable connector

N = No connector
 B = BNC connector
 L = Lemo 4-pin connector

CC is the cable length

00 = No cable
 03 = 3 feet
 06 = 6 feet
 08 = 8 feet
 15 = 15 feet

Sensor

DDD is the sensor type

41 = DT-471
 42 = DT-470, Band 12
 43 = DT-470, Band 13

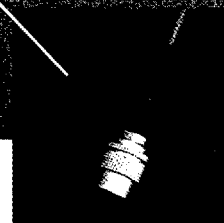

Lemo 4-pin connector

Exceptions to the flow chart

- (1) 22 inch and 28 inch probes come in a 1/4" diameter only.
- (2) If a Detronics hermetic connector (DT02H-12-10PN) is used, a cable is not necessary, therefore:
A = N, B = N, and CC = 00

Probe mounts

The CF™ flange is welded to the probe. The Detronics connector is O-ring sealed to the probe.

Swagelok® fitting

Probes can be easily attached to a system using the Swagelok® fitting. When ordering probes with a Swagelok® fitting, please specify the type of fitting, which must be bored through.

- * For 1/8" diameter probe: P-NPT male pipe size = 1/8".
 For 1/4" diameter probe: P-NPT male pipe size = 1/4".
 Other P-NPT male pipe sizes are available on special request. Please call Lake Shore.

■ 5335450 0000890 274 ■

Curve 10

Measurement Current = 10 microamperes, ±0.05%

All DT-470, DT-471, DT-421, DT-422, DT-450 and DT-414 silicon diode temperature sensors follow the same standard temperature response curve, Curve 10 (table below). Consequently, Lake Shore's silicon diodes can be routinely interchanged with one another in any operating routine involving this response curve. Curve 10 is programmed into all Lake Shore temperature controllers, digital thermometers and cryopump monitors.

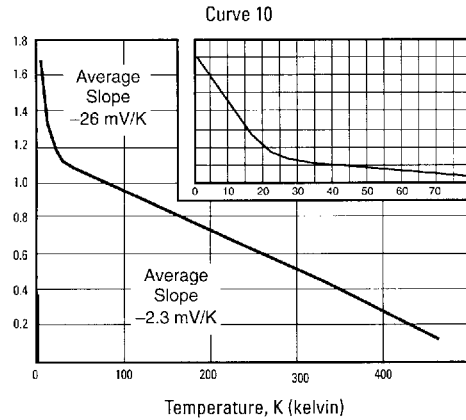

DT470-4-LA-002

Shaded portion highlights truncated portion of Curve 10 corresponding to the reduced temperature range of DT-471 diode sensors. The 1.4 K to 325 K portion of Curve 10 is applicable to the DT-450 miniature silicon diode sensor.

Tolerance Bands for DT-470 Silicon Diodes

Standard Curve 10 Tolerance Bands			
Band	2 K – 100 K	100 K – 305 K	305 K – 475 K
11	±0.25 K	±0.5 K	±1.0 K
11A	±0.25 K	±1% of temp.	±1% of temp.
12	±0.5 K	±1.0 K	±2.0 K
12A	±0.5 K	±1% of temp.	±1% of temp.
13	±1.0 K	±1% of temperature	

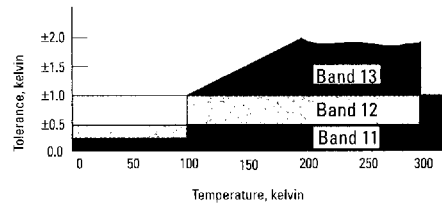

DT 470 4 LA 001

T (K)	Voltage (V)	dV/dT (mV/K)	T (K)	Voltage (V)	dV/dT (mV/K)	T (K)	Voltage (V)	dV/dT (mV/K)
1.40	1.69812	-13.1	16.0	1.28527	-18.6	95.0	0.98564	-2.02
1.60	1.69521	-15.9	16.5	1.27607	-18.2	100.0	0.97550	-2.04
1.80	1.69177	-18.4	17.0	1.26702	-18.0	110.0	0.95487	-2.08
2.00	1.68786	-20.7	17.5	1.25810	-17.7	120.0	0.93383	-2.12
2.20	1.68352	-22.7	18.0	1.24928	-17.6	130.0	0.91243	-2.16
2.40	1.67880	-24.4	18.5	1.24053	-17.4	140.0	0.89072	-2.19
2.60	1.67376	-25.9	19.0	1.23184	-17.4	150.0	0.86873	-2.21
2.80	1.66845	-27.1	19.5	1.22314	-17.4	160.0	0.84650	-2.24
3.00	1.66292	-28.1	20.0	1.21440	-17.6	170.0	0.82404	-2.26
3.20	1.65721	-29.0	21.0	1.19645	-18.5	180.0	0.80138	-2.28
3.40	1.65134	-29.8	22.0	1.17705	-20.6	190.0	0.77855	-2.29
3.60	1.64529	-30.7	23.0	1.15558	-21.7	200.0	0.75554	-2.31
3.80	1.63905	-31.6	24.0	1.13598	-15.9	210.0	0.73238	-2.32
4.00	1.63263	-32.7	25.0	1.12463	-7.72	220.0	0.70908	-2.34
4.20	1.62602	-33.6	26.0	1.11896	-4.34	230.0	0.68564	-2.35
4.40	1.61920	-34.6	27.0	1.11517	-3.34	240.0	0.66208	-2.36
4.60	1.61220	-35.4	28.0	1.11212	-2.82	250.0	0.63841	-2.37
4.80	1.60506	-36.0	29.0	1.10945	-2.53	260.0	0.61465	-2.38
5.00	1.59782	-36.5	30.0	1.10702	-2.34	270.0	0.59080	-2.39
5.50	1.57928	-37.6	32.0	1.10263	-2.08	280.0	0.56690	-2.39
6.00	1.56027	-38.4	34.0	1.09864	-1.92	290.0	0.54294	-2.40
6.50	1.54097	-38.7	36.0	1.09490	-1.83	300.0	0.51892	-2.40
7.00	1.52166	-38.4	38.0	1.09131	-1.77	310.0	0.49484	-2.41
7.50	1.50272	-37.3	40.0	1.08781	-1.74	320.0	0.47069	-2.42
8.00	1.48443	-35.8	42.0	1.08436	-1.72	330.0	0.44647	-2.42
8.50	1.46700	-34.0	44.0	1.08093	-1.72	340.0	0.42221	-2.43
9.00	1.45048	-32.1	46.0	1.07748	-1.73	350.0	0.39783	-2.44
9.50	1.43488	-30.3	48.0	1.07402	-1.74	360.0	0.37337	-2.45
10.0	1.42013	-28.7	50.0	1.07053	-1.75	370.0	0.34881	-2.46
10.5	1.40615	-27.2	52.0	1.06700	-1.77	380.0	0.32416	-2.47
11.0	1.39287	-25.9	54.0	1.06346	-1.78	390.0	0.29941	-2.48
11.5	1.38021	-24.8	56.0	1.05988	-1.79	400.0	0.27456	-2.49
12.0	1.36809	-23.7	58.0	1.05629	-1.80	410.0	0.24963	-2.50
12.5	1.35647	-22.8	60.0	1.05267	-1.81	420.0	0.22463	-2.50
13.0	1.34530	-21.9	65.0	1.04353	-1.84	430.0	0.19961	-2.50
13.5	1.33453	-21.2	70.0	1.03425	-1.87	440.0	0.17464	-2.49
14.0	1.32412	-20.5	75.0	1.02482	-1.91	450.0	0.14985	-2.46
14.5	1.31403	-19.9	80.0	1.01525	-1.93	460.0	0.12547	-2.41
15.0	1.30422	-19.4	85.0	1.00552	-1.96	470.0	0.10191	-2.30
15.5	1.29464	-18.9	90.0	0.99565	-1.99	475.0	0.09062	-2.22

5335450 0000891 100

Ordering Information

Uncalibrated sensor

Specify the **Model number** in the left column only, for example DT-470-BO-11.

Calibrated sensor

Add Calibration Range Suffix Code to the end of the Model number.

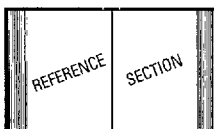

See the Reference Section for a detailed description of:

- Uncalibrated sensors
- SoftCal™
- Calibrated sensors
- CalCurve™
- Sensor packages

Accessories needed for installation (see Section 3):

- Stycast® Epoxy
- Apiezon® Grease
- IMI 7031 Varnish
- Indium Solder
- 90% Pb, 10% Sn Solder
- Phosphor-Bronze Wire
- Manganin Wire
- CryoCable™

DT-470 Model number	Calibration Range Suffix Codes											
	SoftCal™											
	Numeric figure is the low end of the calibration. Letters represent the high end: D = 100 K, L = 325 K, H = 475 K											
	2S	3S	1.4D	1.4H	1.4L	4D	4H	4L	10H	10L	77H	77L
DT-470-BO-11												
DT-470-BO-11A												
DT-470-BO-12												
DT-470-BO-12A												
DT-470-BO-13	✓	✓	✓		✓	✓		✓				✓
DT-470-BR-11												
DT-470-BR-11A												
DT-470-BR-12												
DT-470-BR-12A												
DT-470-BR-13	✓	✓	✓		✓	✓		✓				✓
DT-470-CO/ET/LR/MT-11												
DT-470-CO/ET/LR/MT-11A												
DT-470-CO/ET/LR/MT-12												
DT-470-CO/ET/LR/MT-12A												
DT-470-CO-13	✓	✓	✓	✓	✓	✓	✓	✓			✓	✓
DT-470-CU-11												
DT-470-CU-11A												
DT-470-CU-12												
DT-470-CU-12A												
DT-470-CU-13	✓	✓	✓		✓	✓		✓				✓
DT-470-CY-12												
DT-470-CY-12A												
DT-470-CY-13	✓	✓	✓		✓	✓		✓				✓
DT-470-DI-13												
DT-470-ET-13	✓	✓	✓		✓	✓		✓				✓
DT-470-LR-13	✓	✓	✓		✓	✓		✓				✓
DT-470-MT-13	✓	✓	✓		✓	✓		✓				✓
DT-470-SD-11												
DT-470-SD-11A												
DT-470-SD-12												
DT-470-SD-12A												
DT-470-SD-13	✓	✓	✓	✓	✓	✓	✓	✓			✓	✓
DT-471-BO	✓									✓		✓
DT-471-BR	✓									✓		✓
DT-471-CO	✓								✓	✓	✓	✓
DT-471-CU	✓									✓		✓
DT-471-CY	✓									✓		✓
DT-471-DI	✓									✓		✓
DT-471-ET/LR/MT	✓									✓		✓
DT-471-SD	✓								✓	✓	✓	✓
DT-414-UN						✓		✓				
DT-421-HR	✓		✓		✓	✓		✓				
DT-422-HR	✓		✓		✓	✓		✓				
DT-450-SR-13	✓	✓	✓		✓	✓		✓				



CAUTION The DT-414 is extremely fragile and difficult to handle because of its small size. Lake Shore recommends that an -SD package be used unless there is a size restriction that requires the smaller sensor.

Lake Shore does not warrant mechanical damage to the DT-414.

Handling

1. Fragile assembly, must not be turned over on gold wire bond side. Handle by edges of substrate or by 50 µm diameter gold leads.
2. Unencapsulated device must not be exposed to moisture or corrosive atmosphere.
3. The leads on the DT-414 can **not** be lengthened with a "SMOD" addition as described on page 1-7.

- Accessories available for sensors
- ECRIT Expanded interpolation table.
 - SCR Special calibration report.
 - 8000 Calibration report on floppy disk.
 - COC-SEN Certificate of conformance.



5335450 0000892 047