

19" TFT LCD COLOR MONITOR

Service
Service
Service

190VW8FB/93



Service Manual

TABLE OF CONTENTS

Description	Page	Description	Page
Important Safety Notice	2	Block Diagram	22
Technical Data & Power Management	3 ~ 4	Scaler Board Schematic Diagram	23 ~ 27
Connection to PC	5	Power Board Schematic Diagram	28 ~ 29
OSD Menu Control Level Structure	6	Button Board Schematic Diagram	30
Advanced OSD Adjustment	7	Scaler Board Layout Side View	31 ~ 32
OSD Attention Signal	8	Power Board Layout Side View	33 ~ 34
Safety and troubleshooting information	9	Button Board Layout Side View	35
Definition of Pixel Defects	10 ~ 11	Exploded View	36
Wiring Diagram	12	Recommended Parts List	37 ~ 38
Mechanical Instructions	13 ~ 16	Spare Parts List	39 ~ 41
F/W Upload Instructions	17 ~ 18	Different Parts List	42
DDC Instructions	18 ~ 19	General Trouble Shooting Guide	43 ~ 57
DDC DATA	20	General Product Specification	58 ~ 71
Safety Instructions, Warnings and Notes	21	Safety Check Process	72

SAFETY NOTICE

ANY PERSON ATTEMPTING TO SERVICE THIS CHASSIS MUST FAMILIARIZE HIMSELF WITH THE CHASSIS AND BE AWARE OF THE NECESSARY SAFETY PRECAUTIONS TO BE USED WHEN SERVICING ELECTRONIC EQUIPMENT CONTAINING HIGH VOLTAGES.

CAUTION: USE A SEPARATE ISOLATION TRANSFORMER FOR THIS UNIT WHEN SERVICING.

REFER TO BACK COVER FOR IMPORTANT SAFETY GUIDELINE.

Subject to modification

Oct. 12th. 2007

EN :



PHILIPS
www.DataSheet4U.com

Important Safety Notice

Proper service and repair is important to the safe, reliable operation of all Philips Consumer Electronics Company** Equipment. The service procedures recommended by Philips and described in this service manual are effective methods of performing service operations. Some of these service operations require the use of tools specially designed for the purpose. The special tools should be used when and as recommended.

It is important to note that this manual contains various CAUTIONS and NOTICES which should be carefully read in order to minimize the risk of personal injury to service personnel. The possibility exists that improper service methods may damage the equipment. It is also important to understand that these CAUTIONS and NOTICES ARE NOT EXHAUSTIVE. Philips could not possibly know, evaluate and advise the service trade of all conceivable ways in which service might be done or of the possible hazardous consequences of each way. Consequently, Philips has not undertaken any such broad evaluation. Accordingly, a servicer who uses a service procedure or tool which is not recommended by Philips must first satisfy himself thoroughly that neither his safety nor the safe operation of the equipment will be jeopardized by the service method selected.

** Hereafter throughout this manual, Philips Consumer Electronics Company will be referred to as Philips.

WARNING

Critical components having special safety characteristics are identified with a ▲ by the Ref. No. in the parts list and enclosed within a broken line* (where several critical components are grouped in one area) along with the safety symbol ▲ on the schematics or exploded views.

Use of substitute replacement parts which do not have the same specified safety characteristics may create shock, fire, or other hazards.

Under no circumstances should the original design be modified or altered without written permission from Philips. Philips assumes no liability, express or implied, arising out of any unauthorized modification of design. Servicer assumes all liability.

* Broken Line



FOR PRODUCTS CONTAINING LASER :

- DANGER - In visible laser radiation when open.
AVOID DIRECT EXPOSURE TO BEAM.
- CAUTION - Use of controls or adjustments or performance of procedures other than those specified herein may result in hazardous radiation exposure.
- CAUTION - The use of optical instruments with this Product will increase eye hazard.

TO ENSURE THE CONTINUED RELIABILITY OF THIS PRODUCT, USE ONLY ORIGINAL MANUFACTURER'S REPLACEMENT PARTS, WHICH ARE LISTED WITH THEIR PART NUMBERS IN THE PARTS LIST SECTION OF THIS SERVICE MANUAL.

Take care during handling the LCD module with backlight unit

- Must mount the module using mounting holes arranged in four corners.
- Do not press on the panel, edge of the frame strongly or electric shock as this will result in damage to the screen.
- Do not scratch or press on the panel with any sharp objects, such as pencil or pen as this may result in damage to the panel.
- Protect the module from the ESD as it may damage the electronic circuit (C-MOS).
- Make certain that treatment persons body are grounded through wrist band.
- Do not leave the module in high temperature and in areas of high humidity for a long time.
- Avoid contact with water as it may a short circuit within the module.
- If the surface of panel become dirty, please wipe it off with a soft material.(Cleaning with a dirty or rough cloth may damage the panel.)

1. General Specification

1.1 Panel characteristic

Panel source	: LPL LM190WX1-TLA1 : CMO M190A1-L07
Screen type	: TN+film
Screen dimensions	: 19 inches (diagonal) 16:10

LPL LM190WX1-TAL1

Resolution	: 1440 x 900 (WXGA+)
Outside dimensions	: 427.2(H) X 277.4(V) X 15.3(D)
Pixel pitch (mm)	: 0.095(H) * 0.285(V)
Color pixel arrangement	: R. G. B. Vertical Stripe
Display surface	: Hard-coating (3H), Non-glare type
Color depth	: 16.7M colors
Backlight	: CCFL edge light system
Active area (mm)	: 410.4(H) x 256.5(V)
View angle (CR>10)	: >= 160 for H/V (typical)
Contrast ratio	: >= 1000 : 1
White luminance	: >= 300 nits (7.0mA)
Color gamut	: >= 72%
Response time	: 5 ms

CMO M190A1-L07

Resolution	: 1440 x 900 (WXGA+)
Outside dimensions	: 427.2(H) X 277.4(V) X 17.0(D)
Pixel pitch (mm)	: 0.285(H) * 0.285(V)
Color pixel arrangement	: R. G. B. Vertical Stripe
Display surface	: Hard-coating (3H), Non-glare type
Color depth	: 16.7M colors
Backlight	: CCFL edge light system
Active area (mm)	: 410.4(H) x 256.5(V)
View angle (CR>10)	: >= 170(H)/160(V) (typical)
Contrast ratio	: >= 850 : 1
White luminance	: >= 300 nits (7.0mA)
Color gamut	: >= 72%
Response time	: 5 ms

1.2 Scanning frequencies

Horizontal scan range	: 30 - 83 K Hz (automatic)
Vertical scan range	: 56 - 76 Hz (automatic)

1.3 Video

Video dot rate	: < 140 MHz (Over 140MHz, Warning message will show up)
----------------	--

Input impedance

(Analog signal input)	
- video	: 75 ohm
- Sync	: 2.2K ohm

Input signal levels	: 700 mVpp
Sync. input signals	: Analog R/G/B separate inputs Separate horizontal and vertical / Composite (H+V) TTL level, Sync On Green (SOG) sync 0.3Vp-p Negative

Input impedance (Digital)	: Signal TMDS link (3 channels : Rx0 & Rx1 & RX2-/+)
Video interface	: Both Analog and Digital input. It can be switching via OSD option.

1.5 Physical characteristics

Unit dimensions	
- Width	: 513.8 mm
- Height	: 416.2 mm
- Depth	: 213.6 mm

Packed unit dimensions	
- Width	: 565 mm
- Height	: 174 mm
- Depth	: 472 mm

Packed unit dimensions (China only)	
- Width	: 567 mm
- Height	: 189 mm
- Depth	: 480 mm

Weight (monitor only)	: 5 Kg (Including I/F cable 240g)
-----------------------	-----------------------------------

Title angel	: - 5 ° + 2 / - 0 ° (forward) + 25 ° + 0 / - 3 ° (backward)
-------------	--

Swivel angel	: nil
Height adjustment	: nil
Portrait display	: nil

AC input: - voltage	: AC 90 - 264 V,
- frequency	: 50 / 60 ± 2 Hz

Power consumption	: < 36W maximum
-------------------	-----------------

Ambient temperature	: 0 to 40 degree C
---------------------	--------------------

Operating	
- Temperature	: 5 to 35 degree C
- Humidity	: 85% (max.)
- Altitude	: 0 - 3658 m
- Air pressure	: 600 - 1000 mBAR

Storage	
- Temperature	: -20 to 60 degree C
- Humidity	: 95% max
- Altitude	: 0 - 12192 m
- Air pressure	: 300 - 1100 mBAR (Recommend at 5 to 35 degree C, Humidity less then 60%)

System MTBF	: 50,000 Hrs
-------------	--------------

2. Pin Assignment

2.1 PC analog video input with D - sub connector.

Connector type of analog signal cable :
D - Sub male with DDC2B pin assignment.
Blue connector with thumb-operated jackscrews.

Pin assignment :

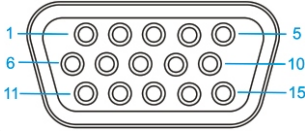

PIN No.	SIGNAL	PIN No.	SIGNAL	PIN No.	SIGNAL
1	Red	6	Red GND	11	Sense (GND)
2	Green/ SOG	7	Green GND	12	Bi-directional data
3	Blue	8	Blue GND	13	H/H+V sync
4	Sense (GND)	9	DDC +3.3V or +5V	14	V-sync
5	Cable Detect (GND)	10	Logic GND	15	Data clock

Data Storage

Factory preset mode:

This monitor has 15 factory-preset modes as indicated in the following table:

Item	H.Freq. (KHz)	Mode	Resolution	V.Freq. (Hz)	BW(MHz)
1	31.469	IBM VGA 10H	640x350	70.086	
2	31.469	IBM VGA 3H	720x400	70.087	
3	31.469	IBM VGA 12H	640x480	59.94	
4	35	MACINTOSH	640x480	67	
5	37.5	VESA	640x480	75	
6	35.156	VESA	800x600	56.25	
7	37.879	VESA	800x600	60.317	
8	46.875	VESA	800x600	75	
9	48.363	VESA	1024x768	60.004	
10	60.023	VESA	1024x768	75.029	
11	63.981	VESA	1280x1024	60.02	
12	79.976	VESA	1280x1024	75.025	
13	55.469	VESA-reduced blanking mode	1440x900	59.901	88.75
14	55.935	VESA	1440x900	59.887	106.5
15	70.635	VESA	1440x900	74.984	136.75

Automatic Power Saving

If you have VESA / DPMS compliance display card or software installed in your PC, the monitor can automatically reduce power consumption when power saving function active. And if an input from keyboard, mouse or other devices is detected, the monitor will automatically wake up. The following table shows the power consumption and signaling of this automatic power saving feature:

Mode	HSYNC	VSYSNC	Video	Pwr-cons.	Indication	Rec. time
Power-On	On	On	active	< 36 W	Green LED	--
Off	Off	Off	blanked	< 1 W	Amber LED	< 3 s
DC Power Off			N/A	< 1 W	LED Off	

This monitor must comply with the Microsoft On Now specification, with two power management states, as defined by the VESA DPMS document. And must appropriately display the DPMS states. Also comply with Environmental Protection Agency (EPA) Energy Star and TCO03 power management standard strictly.



ENERGY STAR is a U.S. Registered mark. AS AN ENERGY STAR PARTNER, PHILIPS HAS DETERMINED THAT THIS PRODUCT MEETS THE ENERGY STAR GUIDELINES OF ENERGY EFFICIENCY.

1. Connection to PC

Please follow the steps to connect your LCD Monitor to PC.

a. Assembly LCD Monitor with base

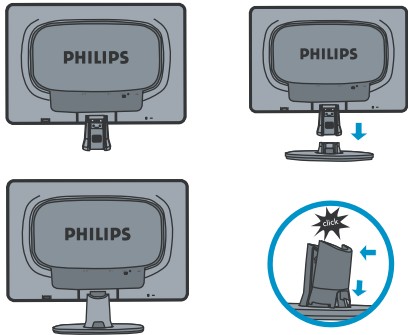

b. Connect to PC

- (1) Turn off your computer and unplug its power cable.
- (2) Connect the monitor signal cable to the video connector on the back of your computer.
- (3) Plug the power cord of your computer and your monitor into a nearby outlet.
- (4) Turn on your computer and monitor. If the monitor displays an image, installation is complete.

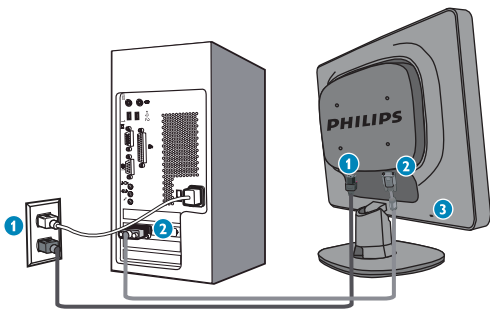

Port definition:

- (1) AC power input
- (2) VGA input
- (3) Kensington anti-thief lock

c. Accessory Pack



2. Function key definition

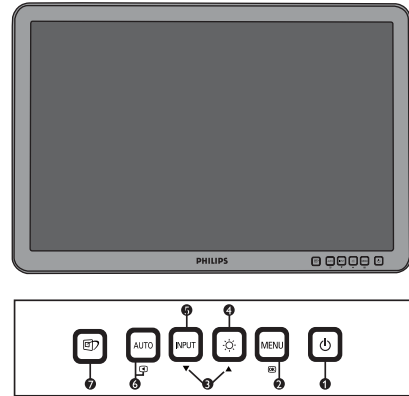

- (1) To switch monitor's power on and off
- (2) To access OSD menu
- (3) To adjust the OSD menu
- (4) To adjust brightness of the display
- (5) To change the signal input source
- (6) Automatically adjust the horizontal position, vertical position, phase and clock Settings/Return to previous OSD level
- (7) SmartImage. There are five modes to be selected: Office Work, Image Viewing, Entertainment, Economy and Off.

3. Description of the On Screen Display

On-Screen Display(OSD) is a feature in all Philips LCD monitors. It allows an end user to adjust screen performance or select functions of the monitors directly through an on-screen instruction window. A user friendly on screen display interface is shown as below:



Basic and simple instruction on the control keys.

According to the above OSD structure, users can :
 press **UP** or **DOWN** buttons to move the cursor,
 press **MENU** button to confirm the choice or change,
 press **UP** or **DOWN** button to adjust the value,
 press **MENU** button to save the changes.
 press **AUTO** button to automatically adjust the horizontal position, vertical position, phase and clock setting.

OSD Menu Control Structure

4. The OSD tree

Below is an overall view of the structure of the On-Screen Display. You can use this as a reference when you want to work your way around the different adjustments later on.

4.1 Only available for China Model

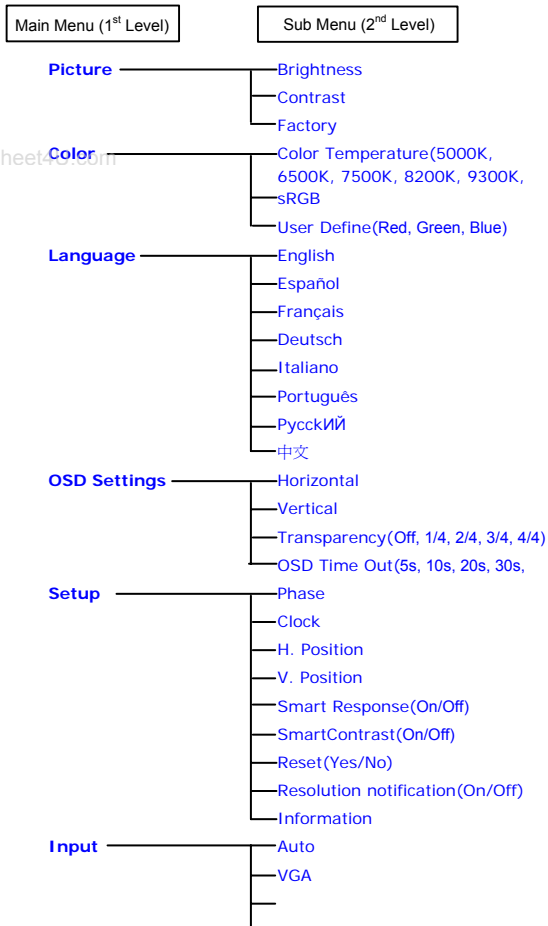

Note:

sRGB is a standard for ensuring correct exchange of colors between different devices(e. g. Digital cameras, monitor, printers, scanners, etc.)

Using a standard unified color space, sRGB will help represent pictures taken by an sRGB compatible device correctly on your sRGB enabled Philips monitor. In that way, the colors are calibrated and you can rely on the correctness of the colors shown on your screen.

Important with the use of sRGB is that the brightness and contrast of your monitor is fixed to a predefined setting as well as the color gamut. Therefore it is important to select the sRGB setting in the monitor's OSD.

To do so, open the OSD by pressing the OK button on the side of your monitor. Move the down button to go to color and press OK again. Use the right button to go to sRGB. Then move the down button and press OK again to exit the OSD.

After this, please do not change the brightness or contrast setting of your monitor. If you change either of these, the monitor will exit the sRGB mode and go to a color temperature setting of 6500K.

Advanced OSD Adjustment

1. Front control panel

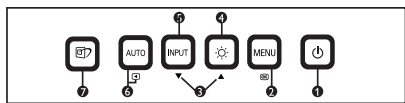

2. To Lock/Unlock OSD function

The OSD function can be locked by pressing **MENU** button for more than 10 seconds, the screen shows following windows for 3 seconds.

www.DataSheet4U.com

Every time when you press any button, this message appears on the screen automatically.

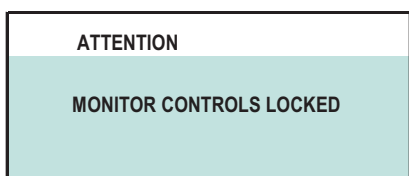

Locked OSD function can be released by pressing **MENU** button for more than 10 seconds. While press **MENU** button for OSD unlocked purpose, the screen will keep showing OSD MAIN MENU LOCKED until OSD function unlocked and screen automatically shows following window for 3 seconds.

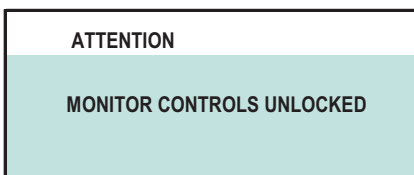

3. Access Factory Mode

To hold **AUTO** and **POWER** buttons, you can saw the LED light flashing at this time. Then release the **AUTO** button and Keep pressing the **POWER** button. The monitor will power on and LED light give out orange light. Press **MENU** to bring up OSD menu for confirmation as below:

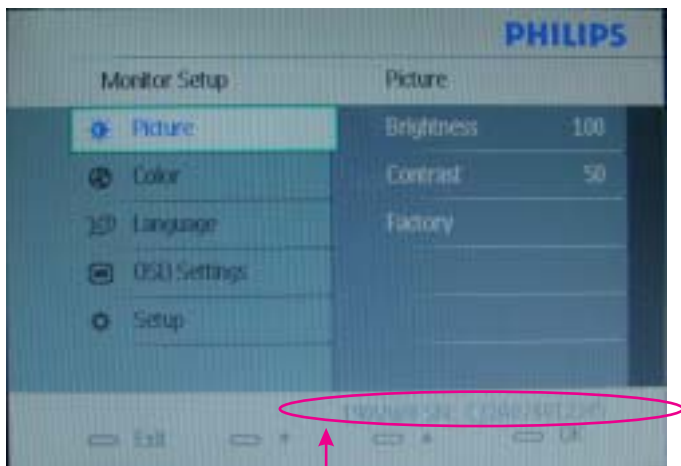

If this message appeared, means monitor already entered the factory mode.

4. Entering Burn-in mode and others

If you access into factory mode, press **MENU-PICTURE-FACTORY**, then press **MENU** to confirm, OSD menu will convert into another format as below:

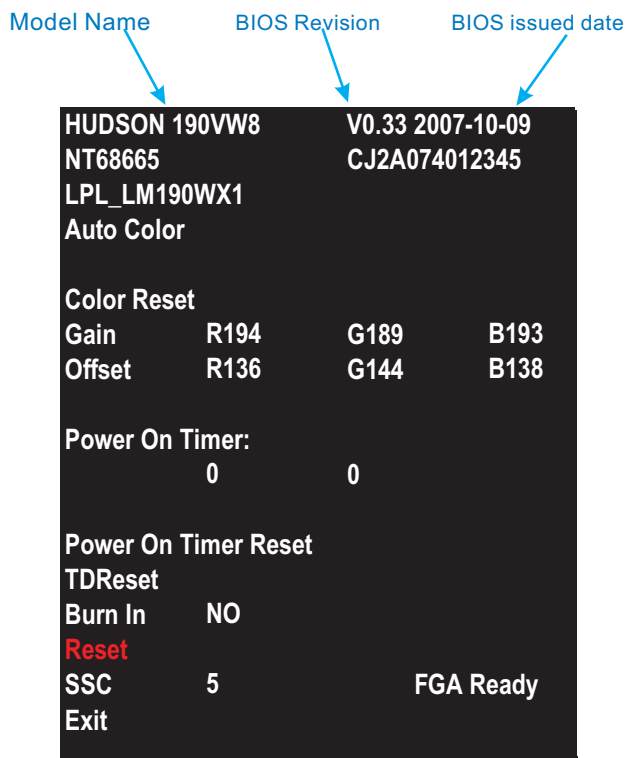

Move the cursor by **MENU** button, and press the **UP** or **DOWN** button to change the burn-in mode from YES to NO.

Leave factory mode by simply power off the monitor.

Warning

- * If you only want to enter burn in mode, please don't change any other setting items as above listed.
- * Unfortunately, if some settings has been changed by unknown reasons or wrong operation. Please refer to the chapter of "W/B Adjustment" to guide the operator how to restore the default settings or do adjustment.

Appendix:

Explanation of above listed selections.

Selection	Description
Burn in On/Off	Enter Aging Mode
Auto Color	Auto Color Adjustment
Con	Contrast Adjustment
Bri	Brightness Adjustment
Gain	ADC Gain Value Adjustment (Auto adjustment by H/W when implement Auto Color function)
Offset	ADC Offset Value Adjustment (Auto adjustment by H/W when implement Auto Color function)
sRGB	sRGB Color Temperature Gain Value Adjustment
9300K	9300K Color Temperature Gain Value Adjustment
6500K	6500K Color Temperature Gain Value Adjustment
Color Update	Save All of Color Temperature Gain Value
Factory Reset	Memory Recall to Factory Default Settings

OSD Attention Signals

Clock & Phase Adjustment

Due to the different quality of video signal generated from graphics cards. It is necessary to adjust CLOCK and PHASE functions for the optimal video display of LCD monitor. So maybe some flicker appeared as Fig.1 & 2.



www.DataSheet4U.com Fig.1

Fig.2

Following steps will guide you to make correct adjustment of CLOCK and PHASE:

- Restart your computer.
- Press **MENU** to bring up OSD menu after the OS (Operation System) boot up.
- Press **UP** or **DOWN** to select the option of **More Settings** and then press **MENU** to bring up its submenu as shown in Fig.3.
- Select the **Clock** or **Phase** adjustment items in submenu and press **UP** or **DOWN** to adjust.
(If the phenomenon as Fig.1, you should adjust "Phase")
(If the phenomenon as Fig.2, you should adjust "Clock")
- Quit OSD by press **MENU** button to save the settings.

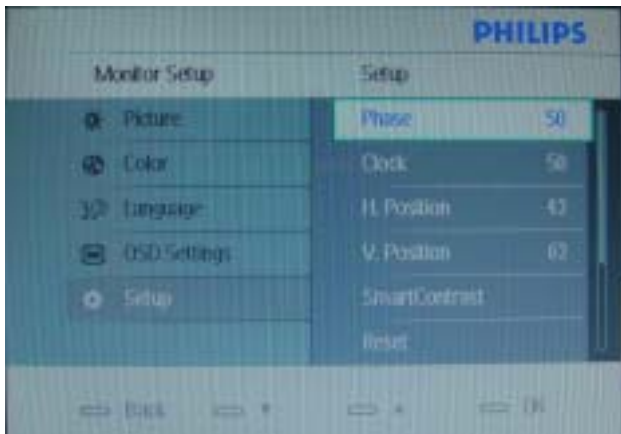

Fig.3

However, CLOCK and PHASE functions are only available while analog video signal is supplied. Operating unit under digital signal state, the video clock information can be obtained from graphics cards directly. Therefore, it is unnecessary to adjust these functions.

OSD Attention signal

The monitor will detect various display situation automatically. When the monitor detects the problems, the screen will show the different warning signals to remind you what is happen to your monitor.

1. CHECK CABLE CONNECTION

This screen appears if there is no video signal input. Please check that the signal cable is properly connected to the video card of PC and make sure PC is on.

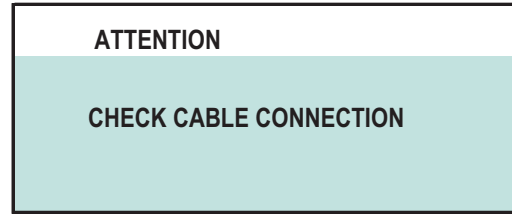

2. AUTO ADJUSTMENT

This screen appears when you touch the **AUTO** button. It will disappear when the monitor is properly adjusted.

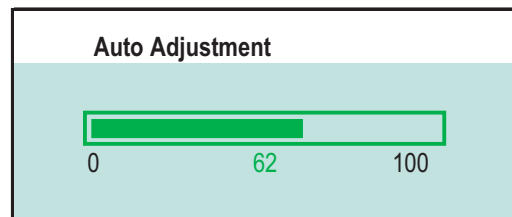

3. USE 1440X900 FOR BEST RESULT

This message appears at the top of the OSD window when the video mode input is not the recommended 1440*900. Other modes may result in some picture distortion. Please adjust the video mode to 1440*900 at 60Hz for best display quality.

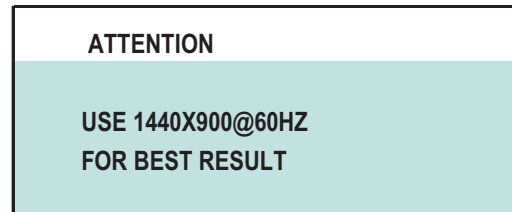

4. NO VIDEO INPUT

When you select video input between AUTO, VGA or DVI signal via INPUT function of OSD menu, if the DVI function you are selecting is not available, following message will appear on the screen.

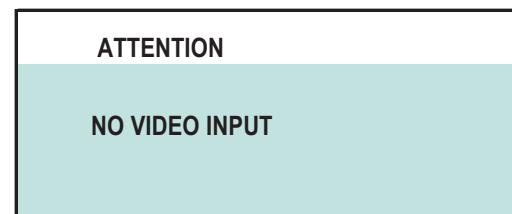

5. VGA(D-SUB)

When you select VGA function, if it's not available, following message will appear on the screen.

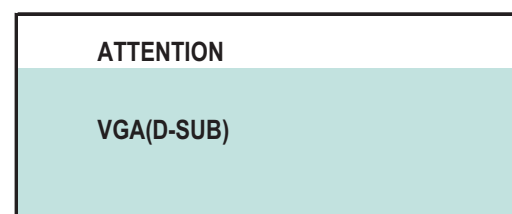

Safety precautions and maintenance

WARNING: Use of controls, adjustments or procedures other than those specified in this documentation may result in exposure to shock, electrical hazards and/or mechanical hazards.

Read and follow these instructions when connecting and using your computer monitor:

- To protect your display from possible damage, do not put excessive pressure on the LCD panel. When moving your monitor, grasp the frame to lift; do not lift the monitor by placing your hand or fingers on the LCD panel.
- Unplug the monitor if you are not going to use it for an extensive period of time.
- Unplug the monitor if you need to clean it with a slightly damp cloth. The screen may be wiped with a dry cloth when the power is off. However, never use alcohol, solvents or ammonia-based liquids.
- Consult a service technician if the monitor does not operate normally when you have followed the instructions in this manual.
- The casing cover should be opened only by qualified service personnel.
- Keep the monitor out of direct sunlight and away from stoves or any other heat source.
- Remove any object that could fall into the vents or prevent proper cooling of the monitor's electronics.
- Do not block the ventilation holes on the cabinet.
- Keep the monitor dry. To avoid electric shock, do not expose it to rain or excessive moisture.
- When positioning the monitor, make sure the power plug and outlet are easily accessible.
- If turning off the monitor by detaching the power cable or DC power cord, wait for 6 seconds before attaching the power cable or DC power cord for normal operation.
- To avoid the risk of shock or permanent damage to the set, do not expose the monitor to rain or excessive moisture.
- IMPORTANT:** Always activate a screen saver program during your application. If a still image in high contrast remains on the screen for an extended period of time, it may leave an 'after-image' or 'ghost image' on front of the screen. This is a well-known phenomenon that is caused by the shortcomings inherent in LCD technology. In most cases, the afterimage will disappear gradually over a period of time after the power has been switched off. Be aware, that the afterimage symptom cannot be repaired and is not covered under warranty.
- Warning for lifting monitor - Do not use the area underneath the logo cover to grip or lift the monitor. Placing weight on the logo cover can cause it to break away from the body and cause the monitor to fall. When lifting the monitor, place one hand under the monitor's frame.

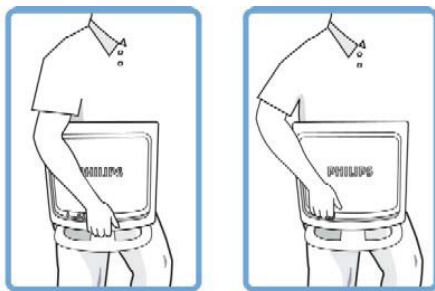

○ Do

✗ Don't

* Consult a service technician if the monitor does not operate normally when the operating instructions given in this manual have been followed.

Installation Locations

Avoid exposure to heat and extreme cold.

Do not store or use the LCD monitor in locations exposed to heat, direct sunlight or extreme cold.

Avoid moving the LCD monitor between locations with large temperature differences. Choose a site that falls within the following temperature and humidity ranges.

Temperature: 0-35°C 32-95°F

Humidity: 20-80% RH

Do not subject the LCD monitor to severe vibration or high impact conditions. Do not place the LCD monitor in the trunk of a car.

Take care not to mishandle this product by either knocking or dropping it during operation or transportation.

Do not store or use the LCD monitor in locations where there is a high level of humidity or in dusty environments. Do not allow water or other liquids to spill on or into the LCD monitor.

Trouble Shooting

This page deals with problems that can be corrected by the user. If the problem still persists after you have tried these solutions, contact your nearest Philips dealer.

Common Problems	
Having this problem	Check these items
No Picture (Power LED not lit)	<ol style="list-style-type: none"> Make sure the power cord is plugged into the power outlet and into the back of the monitor. First, ensure that the power button on the front of the monitor is in the OFF position, then press it to the ON position.
No Picture (Power LED is amber or yellow)	<ol style="list-style-type: none"> Make sure the computer is turned on. Make sure the signal cable is properly connected to your computer. Check to see if the monitor cable has bent pins. The Energy Saving feature may be activated.
Screen says	<ol style="list-style-type: none"> Make sure the monitor cable is properly connected to your computer. (Also refer to the Quick Set-Up Guide). Check to see if the monitor cable has bent pins. Make sure the computer is turned on.
Screen says	<ol style="list-style-type: none"> Make sure the monitor cable is properly connected to your computer. (Also refer to the Quick Set-Up Guide). Check to see if the monitor cable has bent pins. Make sure the computer is turned on.
AUTO button not working properly	<ol style="list-style-type: none"> The Auto Function is designed for use on standard Macintosh or IBM-compatible PCs running Microsoft Windows. It may not work properly if using nonstandard PC or video card.
Imaging Problems	
Display position is incorrect	<ol style="list-style-type: none"> Press the Auto button. Adjust the image position using the Phase/Clock of More Settings in OSD Main Controls.
Image vibrates on the screen	<ol style="list-style-type: none"> Check that the signal cable is properly connected to the graphics board or PC.
Vertical flicker appears	<ol style="list-style-type: none"> Press the Auto button. Eliminate the vertical bars using the Phase/Clock of More Settings in OSD Main Controls.
Horizontal flicker appears	<ol style="list-style-type: none"> Press the Auto button. Eliminate the vertical bars using the Phase/Clock of More Settings in OSD Main Controls.

Definition of Pixel Defects

The screen is too bright or too dark	Adjust the contrast and brightness on On-Screen Display. (The backlight of the LCD monitor has a fixed life span. When the screen becomes dark or begins to flicked, please contact your sales representative).
An after-image appears	If an image remains on the screen for an extended period of time, it may be imprinted in the screen and leave an after-image. This usually disappears after a few hours.
An after-image remains after the power has been turned off	This is characteristic of liquid crystal and is not caused by a malfunction or deterioration of the liquid crystal. The after-image will disappear after a period of time.
Green, red, blue, dark, and white dots remains	The remaining dots are normal characteristic of the liquid crystal used in today's technology.
For further assistance, refer to the Consumer Information Centers list and contact your local Philips distributor.	

Definition of Pixel Defects

This section explains the different types of pixel defects and defines acceptable defect levels of each type. In order to qualify for repair or replacement under warranty, the number of pixel defects on a TFT LCD panel must exceed these acceptable levels.

1. Definition of Pixels and Sub-pixels

A pixel, or picture element, is composed of three sub pixels in the primary colors of red, green and blue. Many pixels together form an image. When all sub pixels of a pixel are lit, the three colored sub pixels together appear as a single white pixel. When all are dark, the three colored sub pixels together appear as a single black pixel. Other combinations of lit and dark sub pixels appear as single pixels of other colors.

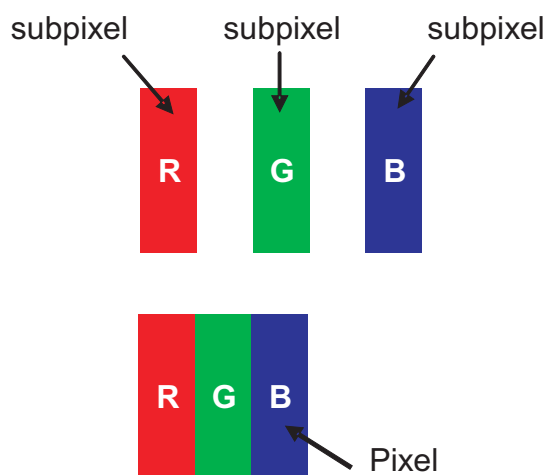

2. Types of Pixel Defects

Pixel and sub pixel defects appear on the screen in different ways. There are two categories of pixel defects and several types of sub pixel defects within each category.

Bright Dot Defects

Bright dot defects appear as pixels or sub pixels that are always lit or 'on'. That is, a bright dot is a sub-pixel that stands out on the screen when the monitor displays a dark pattern. There are the types of bright dot defects:

One lit red, green or blue sub pixel

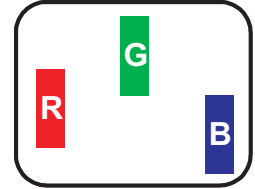

Two adjacent lit sub pixels:

- Red + Blue = Purple
- Red + Green = Yellow
- Green + Blue = Cyan (Light Blue)

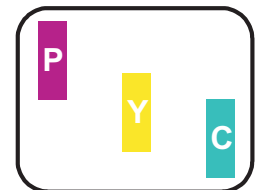

Three adjacent lit sub pixels (one white pixel)



A red or blue bright dot must be more than 50 percent brighter than neighboring dots while a green bright dot is 30 percent brighter than neighboring dots.

Black Dot Defects

Black dot defects appear as pixels or sub pixels that are always dark or 'off'. That is, a dark dot is a sub-pixel that stands out on the screen when the monitor displays a light pattern. These are the types of black dot defects:

One dark sub pixel

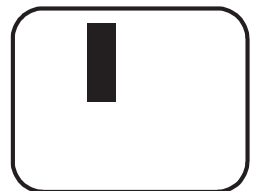

Two or three adjacent dark sub pixels

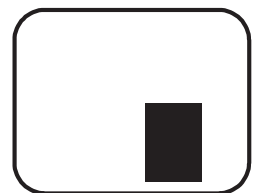

3. Proximity of Pixel Defects

Because pixel and sub pixels defects of the same type that are near to one another may be more noticeable, Philips also specifies tolerances for the proximity of pixel defects.

Perfect Panel - ISO 13406-2 Class II compliant do-defect-free-display.

BRIGHT DOT DEFECTS	ACCEPTABLE LEVEL
<i>MODEL</i>	<i>190VW8</i>
1 lit subpixel	3 or fewer
2 adjacent lit subpixels	1 or fewer
3 adjacent lit subpixels (one white pixel)	0
Distance between two bright dot defects*	>15mm
Total bright dot defects of all types	3 or fewer

BLACK DOT DEFECTS	ACCEPTABLE LEVEL
<i>MODEL</i>	<i>190VW8</i>
1 dark subpixel	5 or fewer
2 adjacent dark subpixels	2 or fewer
3 adjacent dark subpixels	0
Distance between two black dot defects*	>15mm
Total black dot defects of all types	5 or fewer

TOTAL DOT DEFECTS	ACCEPTABLE LEVEL
<i>MODEL</i>	<i>190VW8</i>
Total bright or black dot defects of all types	5 or fewer

Note:

* 1 or 2 adjacent sub pixel defects = 1 dot defect

Wiring Diagram

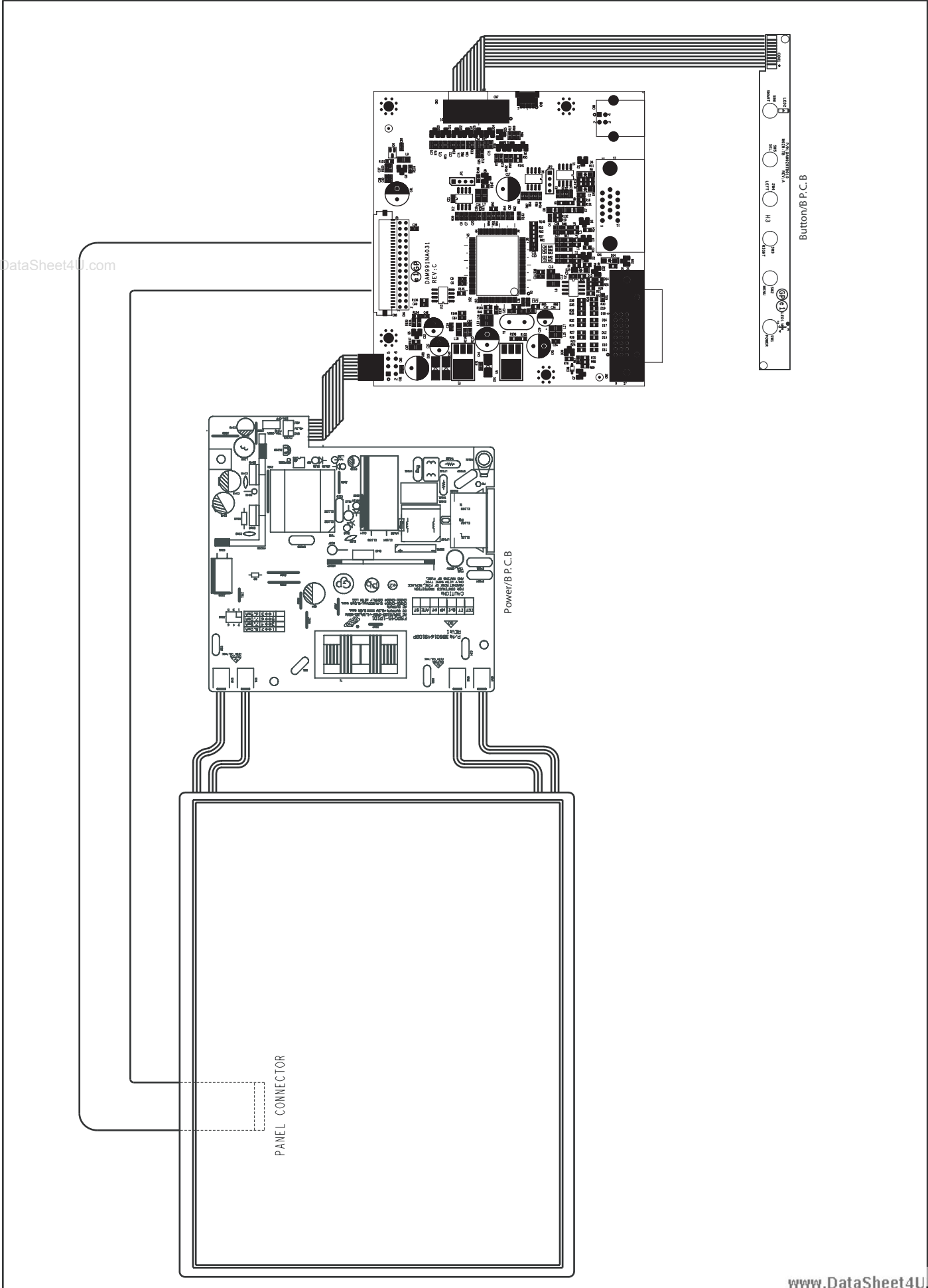



Fig. 1

1. Put down the LCD, all tools prepared.



Fig. 4

4. Take off hinge cover.



Fig. 2

2. Take off the hinge cover.



Fig. 5

5. Release 4pcs screws from stand neck and take off it.



Fig. 3

3. Press the button and take off base.



Fig. 6

6. Separate rear cover from bezel.



Fig. 7

7. Release 3pcs screws from left side of bezel.



Fig. 10

10. Separate bezel from panel.



Fig. 8

8. Release 3pcs screws from right side of bezel.



Fig. 11

11. Release 1pcs screw from Power shielding and take off it.



Fig. 9

9. Tear off the tapes and disconnect the MB-BB cable.



Fig. 12

12. Disconnect the lamp cables.

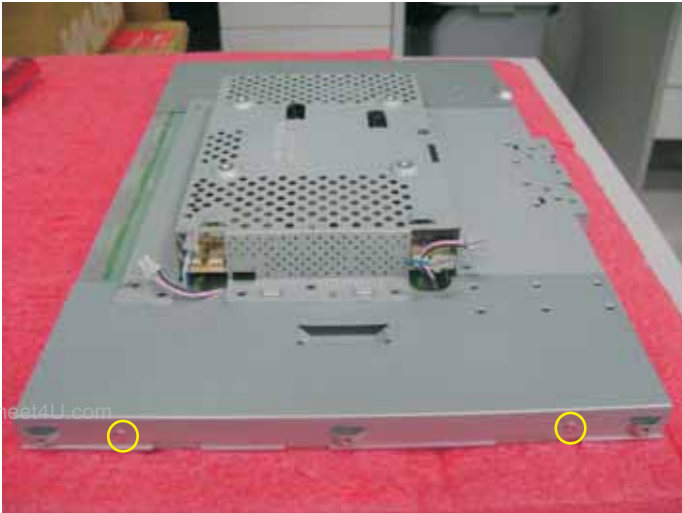

Fig. 13

13. Release 2pcs screws from left side of panel shielding.



Fig. 16

16. Tear off the tape and disconnect LVDs cable.



Fig. 14

14. Release 2pcs screws from right side of panel shielding.



Fig. 17

17. Separate panel shielding from panel.

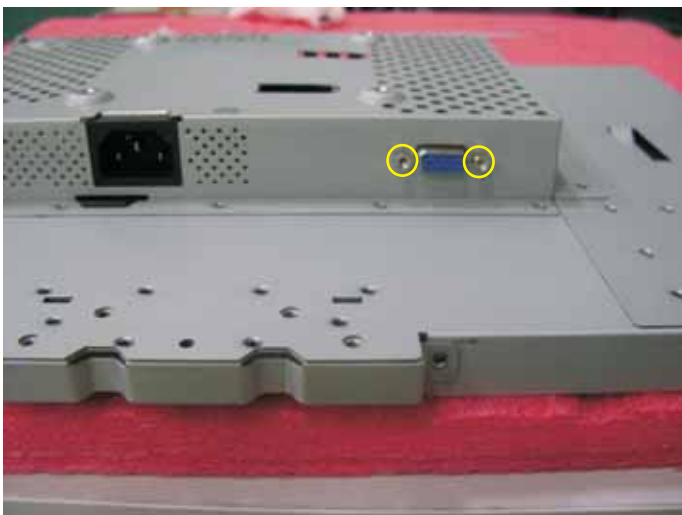

Fig. 15

15. Release 2pcs screws from VGA joint.



Fig. 18

18. Take off power mylar.



Fig. 19

19. Release 8pcs screws from Main/B and Power/B.



Fig. 22

22. The Power/B.

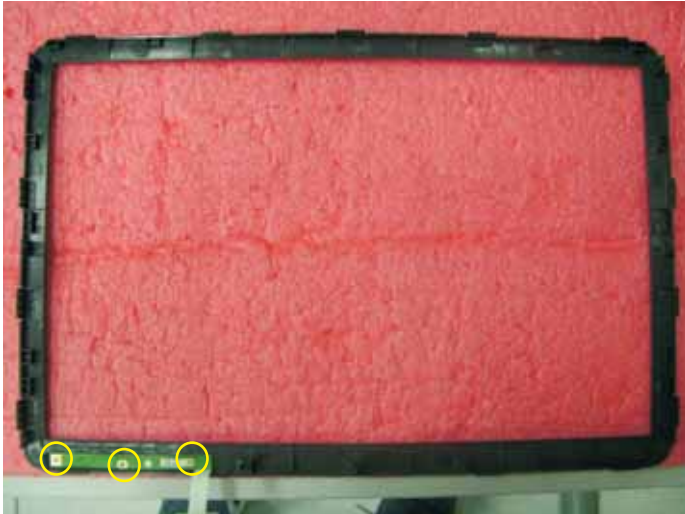

Fig. 20

20. Release 3pcs screws from Button/B and take off it from bezel.

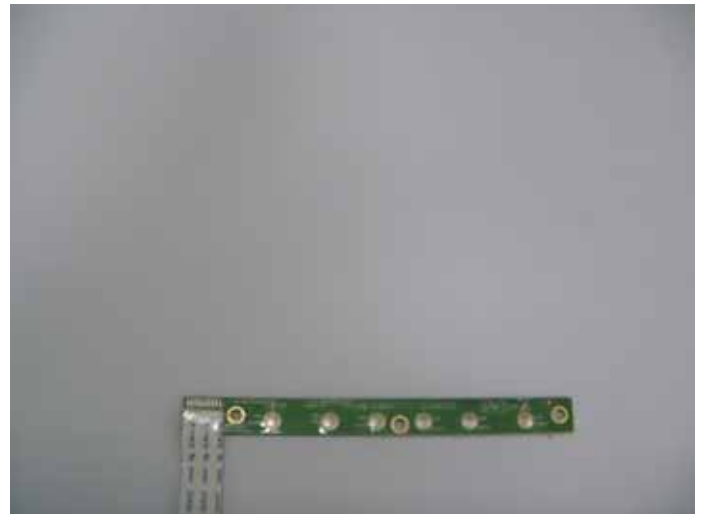

Fig. 23

23. The Button/B.



Fig. 21

21. The Main/B.

F/W upload instruction

Configuration and procedure (ISP Tool)

"ISP Tool " software is provided by NOVATEK to upgrade the firmware of Scaler IC. It is a windows-based program, which cannot be run in MS-DOS.

System and equipment requirements:

1. An i486 (or above) personal computer or compatible.
2. Microsoft operation system Windows 98/2000/XP.
3. ISP software " EasyUSB Writer " .
(Need to install, it can not be performed directly. Double press "EasyUSB WriterV3.0.exe" to start installing, then chose the path that you want to install ,then it will perform automatically.)
4. Firmware uploading tool, as shown in Fig1.

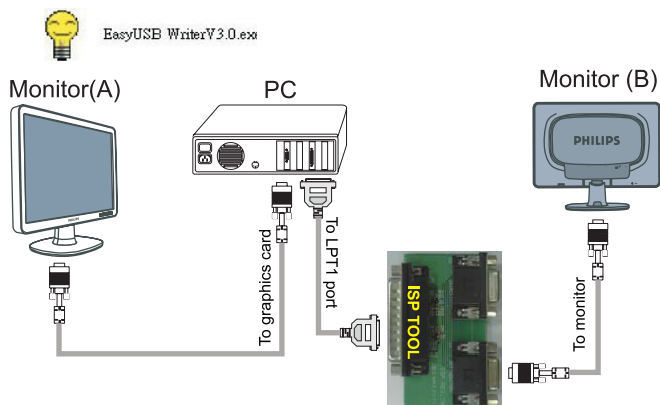

Fig.1

- * Connect the firmware uploading tool as Fig.1 shown.
- * Before the servicer perform the ISP Tool program, the Communicating connection must be well done.
- * When the connection fixed, power on the monitor.

Setup and perform the ISP Tool program

1. Save the software in your PC, and create a shortcut on the desktop.
2. Double click the ISP Tool. exe icon at the desktop then appears window as shown in Fig. 2.

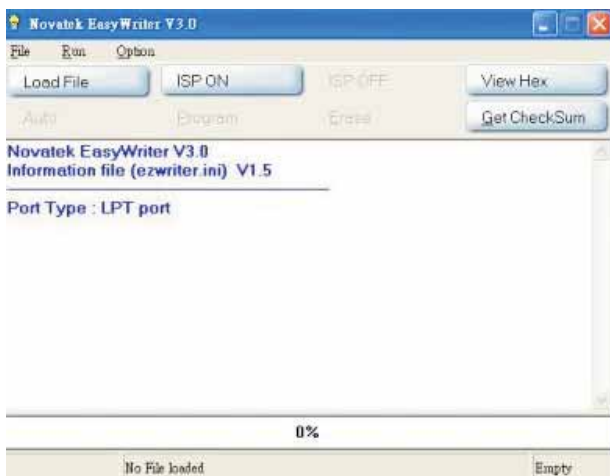

Fig. 2

3. Press the "Load File" button then select the path that save hex file ,then chose file type as "Bank Switch(128K,256K)" as shown in Fig. 3.



Fig. 3

4. Double press the "H00" file or "H01 file" ,then it acquires the hex file automatically, and a message will be showed in the dialog box to notice the operator. At this moment, please verify the checksum of the hex file with the firmware control table to make sure the suitable file will be used. Mentioned firmware control table will be provided by suppliers shown in Fig. 4.

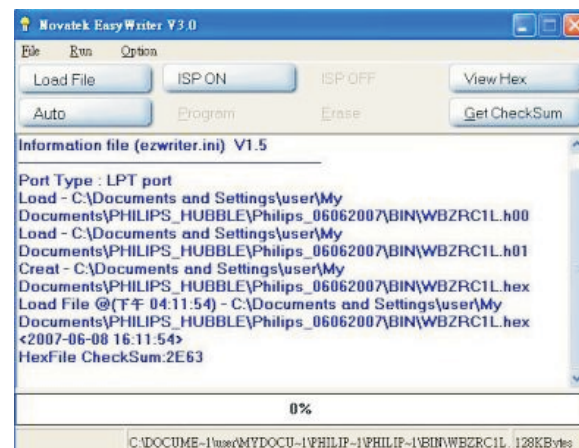

Fig. 4

5. Press the "ISP ON" button ,then the dialog box will has the information "ISP ON" ,else has the information "ISP Fail".If the information is "ISP Fail" ,check the connectivity ,then try it again as shown in Fig.5

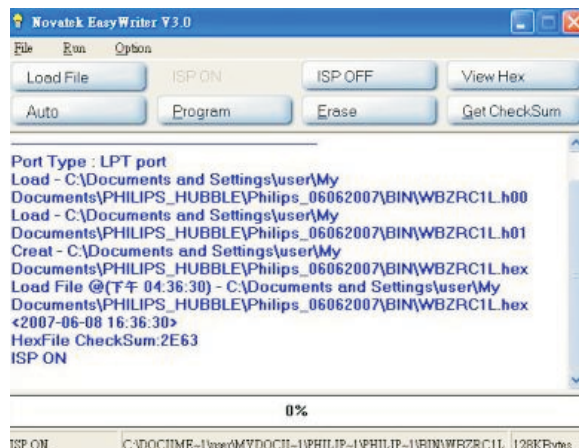

Fig. 5

6. Press "Auto" button of the toolbox. Program will perform the loading process automatically. When the loading process completed, and the dialog box appeared the message of Programming Success. If Program perform fail ,resume step 5.

www.DataSheet4U.com

DDC instructions

General

DDC Data Re-programming

In case the DDC data memory IC or main EEPROM which storage all factory settings were replaced due to a defect, the serial numbers have to be re-programmed.

It is advised to re-soldered DDC IC and main EEPROM from the old board onto the new board if circuit board have been replaced, in this case the DDC data does not need to be re-programmed.

* According to the design concept of this product, DDC data will be divided into two parts to deposit in different place:
DDC data of VGA interface are saved in scaler IC.

Additional information

Additional information about DDC (Display Data Channel) may be obtained from Video Electronics Standards Association (VESA). Extended Display Identification Data(EDID) information may be also obtained from VESA.

System and equipment requirements

1. An i486 (or above) personal computer or compatible.
2. Microsoft operation system Windows 98/2000/XP.
3. Installation software of " TVI Tool ".
4. Executive program " TVI Tool. exe ".
5. ISP tool kit, as shown in Fig1.
 - a. Alignment fixture x 1
 - b. Printer cable (LPT type) x 1
 - c. D-sub to D-sub cable x 1

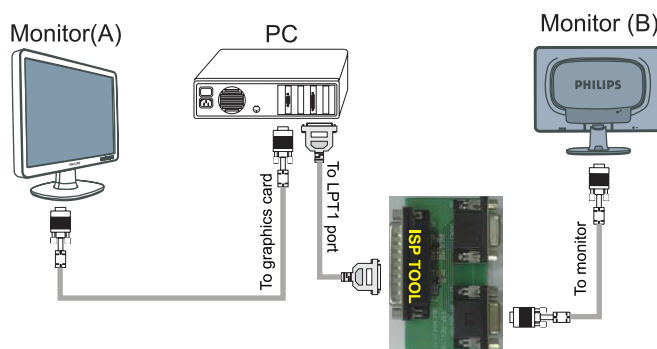
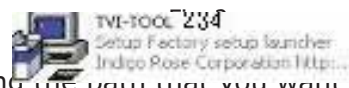

Fig. 1

Install and setup TVI-TOOL program

Step 1: Double press the "TVI-TOOL_234.exe".

Step 2: In Company text box key in any word as shown in the Fig.2.



Step 3: Chosing the path that you want to install,then chose the shortcut folder ,press

Step 3: Closing the path that you want to install, then chose the shortcut folder ,press "Install" button ,and it will perform automatically.

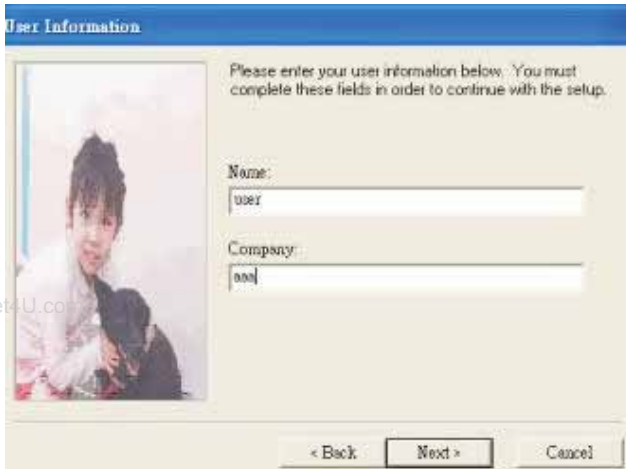

Fig.3

Re-programming Analog DDC IC

Step 1: After initialize the alignment fixture, connecting all cables. Be using VGA port from monitor.

Step 2: Connect the power code of monitor and power on it.

Step 3: Double check the TVI_TOOL icon to run the TV_TOOL.exe.

Step 4: Click the OPEN icon at the main menu to open the DDC files.



Fig. 4

Step 5: In the "Detailed Timings" BLOCK2 key in the monitor serial number.

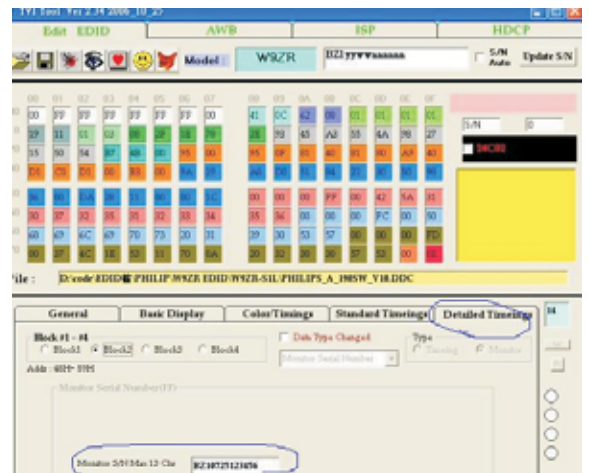

Fig. 5

Step 6: Press "WRITE TO IC " button in the tool bar ,when the DDC data download into the DDC IC, a dialog box will be appeared automatically as shown in below photos.



Fig. 6

Step 7: Power off the monitor.

DDC Data

DDC DATA

THE DISPLAY DATA CHANNEL (DDC_2B) CONTENT INCLUDING:
(Analog mode)

128 BYTES OF EDID CODE :

	0	1	2	3	4	5	6	7	8	9
0	00	FF	FF	FF	FF	FF	FF	00	41	0C
10	60	08	01	01	01	01	1B	11	01	03
20	0E	28	19	78	2A	A1	50	A3	57	4C
30	9D	25	11	50	54	BF	EE	80	71	4F
40	95	00	95	0F	01	01	01	01	01	01
50	01	01	01	01	9A	29	A0	D0	51	84
60	22	30	50	98	36	00	90	FA	10	00
70	00	1C	00	00	00	FF	00	42	5A	31
80	30	37	32	35	30	37	30	37	31	30
90	00	00	00	FC	00	50	68	69	6C	69
100	70	73	20	31	39	30	56	57	00	00
110	00	FD	00	38	4C	1E	53	0E	70	0A
120	20	32	30	30	57	53	00	45		

- (08-09) ID Manufacturer Name = PHL
 (10-11) Product ID Code (Non-Alphanumeric) = 0860 - (2144)
 (12-15) Last 5 Digits of Serial Number = NOT SPECIFIED
 (16) Week of Manufacture = 27
 (17) Year of Manufacture = 2007
 (10-17) Complete Serial Number = NOT SPECIFIED
 (18) EDID Structure Version Number = 1
 (19) EDID Structure Revision Number = 3
 (20) VIDEO INPUT DEFINITION : =
 Separate Sync, Composite Sync, Sync on Green,
 Analog signal, 0.700V/0.300V (1.000 Vp-p)
 (21) Maximum Horizontal Image Size = 400mm
 (22) Maximum Vertical Image Size = 250mm
 (23) Display Gamma = 2.20
 (24) DPMS Supported Feature: = Active Off.
 Display type = RGB color display

- (25-34) CHROMA INFO:
 Red x = 0.639 Green x = 0.297
 Blue x = 0.146 White x = 0.312
 Red y = 0.342 Green y = 0.614
 Blue y = 0.067 White y = 0.328

- (35) ESTABLISHED TIMING I:
 720 x 400 @ 70Hz (VGA, IBM)
 640 x 480 @ 60Hz (VESA)
 640 x 480 @ 67Hz (MAC II, Apple)
 640 x 480 @ 72Hz (VESA)
 640 x 480 @ 75Hz (VESA)
 800 x 600 @ 56Hz (VESA)
 800 x 600 @ 60Hz (VESA)

- (36) ESTABLISHED TIMING II:
 800 x 600 @ 72Hz (VESA)
 800 x 600 @ 75Hz (VESA)
 832 x 624 @ 75Hz (MAC II, Apple)
 1024 x 768 @ 60Hz (VESA)
 1024 x 768 @ 70Hz (VESA)
 1024 x 768 @ 75Hz (VESA)

- (37) Manufacturer's Reserved Timing:
 1152 x 870 @ 75Hz (MAC II, Apple)

(38-53) Standard Timing Identification:

- #1: 1152 x 864 @ 75Hz
 #2: 1440 x 900 @ 60Hz
 #3: 1440 x 900 @ 75Hz
 #4: (44) not specified
 #5: (46) not specified
 #6: (48) not specified
 #7: (50) not specified
 #8: (52) not specified

(54-71) Detail Timing Description #1: 1440x900
 Pixel Clock=106.5MHz

 Horizontal Image Size=400mm
 Vertical Image Size=250mm
 Refresh Mode:
 Non-Interlaced Normal display, no stereo

HORIZONTAL:
 Active Time = 1440 pixels
 Blanking Time = 464 pixels
 Sync Offset = 80 pixels
 Sync Pulse Width = 152 pixels
 Border = 0 pixels
 Frequency = 55.9 kHz

VERTICAL:
 Active Time = 900 lines
 Blanking Time = 34 lines
 Sync Offset = 3 lines
 Sync Pulse Width = 6 lines
 Border = 0 lines
 Frequency = 59.9 Hz

Sync configuration: Digital separate, V(+), H(-)

(72-89) Monitor Description:

 Monitor S/N: BZ10725070710

(90-107) Monitor Description:

 Monitor Name: Philips 190VW

(108-125) Monitor Description:

 Monitor Range Limits:
 Vertical Frequency (min) = 56Hz
 Vertical Frequency (max) = 76Hz
 Horizontal Frequency (min) = 30KHz
 Horizontal Frequency (max) = 83KHz
 Maximum Supported Pixel Clock = 140MHz

(127) Checksum OK.

Safety instruction, warnings and notes

index of this chapter:

- 1 Safety Instructions
- 2 Warnings
- 3 Notes

1 Safety Instructions

Safety regulations require that during a repair:

- a. Connect the set to the AC Power via an isolation transformer (> 800 VA).
- b. Replace safety components, indicated by the symbol ▲, only by components identical to the original ones. Any other component substitution (other than original type) may increase risk of fire or electrical shock hazard.

Safety regulations require that after a repair, the set must be returned in its original condition. Pay in particular attention to the following points:

- a. Route the wire trees correctly and fix them with the mounted cable clamps.
- b. Check the insulation of the AC Power lead for external damage.
- c. Check the strain relief of the AC Power cord for proper function.
- d. Check the electrical DC resistance between the AC Power plug and the secondary side (only for sets which have a AC Power isolated power supply):
 - * Unplug the AC Power cord and connect a wire between the two pins of the AC Power plug.
 - * Set the AC Power switch to the "on" position (keep the AC Power cord unplugged!).
 - * Measure the resistance value between the pins of the AC Power plug and the metal shielding of the tuner or the aerial connection on the set. The reading should be between 4.5 Mohm and 12 Mohm.
 - * Switch "off" the set, and remove the wire between the two Pins of the AC Power plug.
- e. Check the cabinet for defects, to avoid touching of any inner parts by the customer.

2 Warnings

- a. All ICs and many other semiconductors are susceptible to electrostatic discharges (ESD ▲). Careless handling during repair can reduce life drastically. Make sure that, during repair, you are connected with the same potential as the mass of the set by a wristband with resistance. Keep components and tools also at this same potential.
- b. Be careful during measurements in the high voltage section.
- c. Never replace modules or other components while the unit is switched "on".
- d. When you align the set, use plastic rather than metal tools. This will prevent any short circuits and the danger of a circuit becoming unstable.

3 Notes

3.1 General

Measure the voltages and waveforms with regard to the chassis ground or hot ground, depending on the tested area of circuitry. The voltages and waveforms shown in the diagrams are indicative.

The semiconductors indicated in the circuit diagram and in the parts lists, are interchangeable per position with the semiconductors in the unit, irrespective of the type indication on

3.2 Schematic Notes

All resistor values are in ohms and the value multiplier is often used to indicate the decimal point location (e.g. 2K2 indicates 2.2 Kohm).

Resistor values with no multiplier may be indicated with either an "E" or an "R" (e.g. 220E or 220R indicates 220 ohm).

All capacitor values are given in micro-farads ($\times 10^{-6}$), nano-farads ($n= \times 10^{-9}$), or pico-farads ($p= \times 10^{-12}$).

Capacitor values may also use the value multiplier as the decimal point indication (e.g. 2p2 indicates 2.2 pF).

An "asterisk" (*) indicates component usage varies. Refer to the diversity tables for the correct values.

The correct component values are listed in the Electrical Replacement Parts List. Therefore, always check this list when there is any doubt.

3.3 Lead Free Solder

Philips CE is going to produce lead-free sets (PBF) from 1.1.2005 onwards.

Lead-free sets will be indicated by the PHILIPS-lead-free logo on the Printed Wiring Boards (PWB):



Figure 2-1 Lead-free logo

This sign normally has a diameter of 6 mm, but if there is less space on a board also 3 mm is possible.

In case of doubt whether the board is lead-free or not (or with mixed technologies), you can use the following method:

- * Always use the highest temperature to solder, when using SAC305 (see also instructions below).
- * De-solder thoroughly (clean solder joints to avoid mix of two alloys).

Caution: For BGA-ICs, you must use the correct temperature profile, which is coupled to the 12NC. For an overview of these profiles, visit the website <http://www.atyourservice.ce.philips.com/>. You will find this and more technical information within the "Magazine", chapter "Workshop information".

For additional questions please contact your local repair desk.

Due to lead-free technology some rules have to be respected by the workshop during a repair:

Use only lead-free soldering tin Philips SAC305 with order code 0622 149 00106. If lead-free solder paste is required, please contact the manufacturer of your soldering equipment. In general, use of solder paste within workshops should be avoided because paste is not easy to store and to handle.

Use only adequate solder tools applicable for lead-free soldering tin. The solder tool must be able

- To reach at least a solder-tip temperature of 400 degree C.
- To stabilise the adjusted temperature at the solder-tip.
- To exchange solder-tips for different applications.

Block Diagram

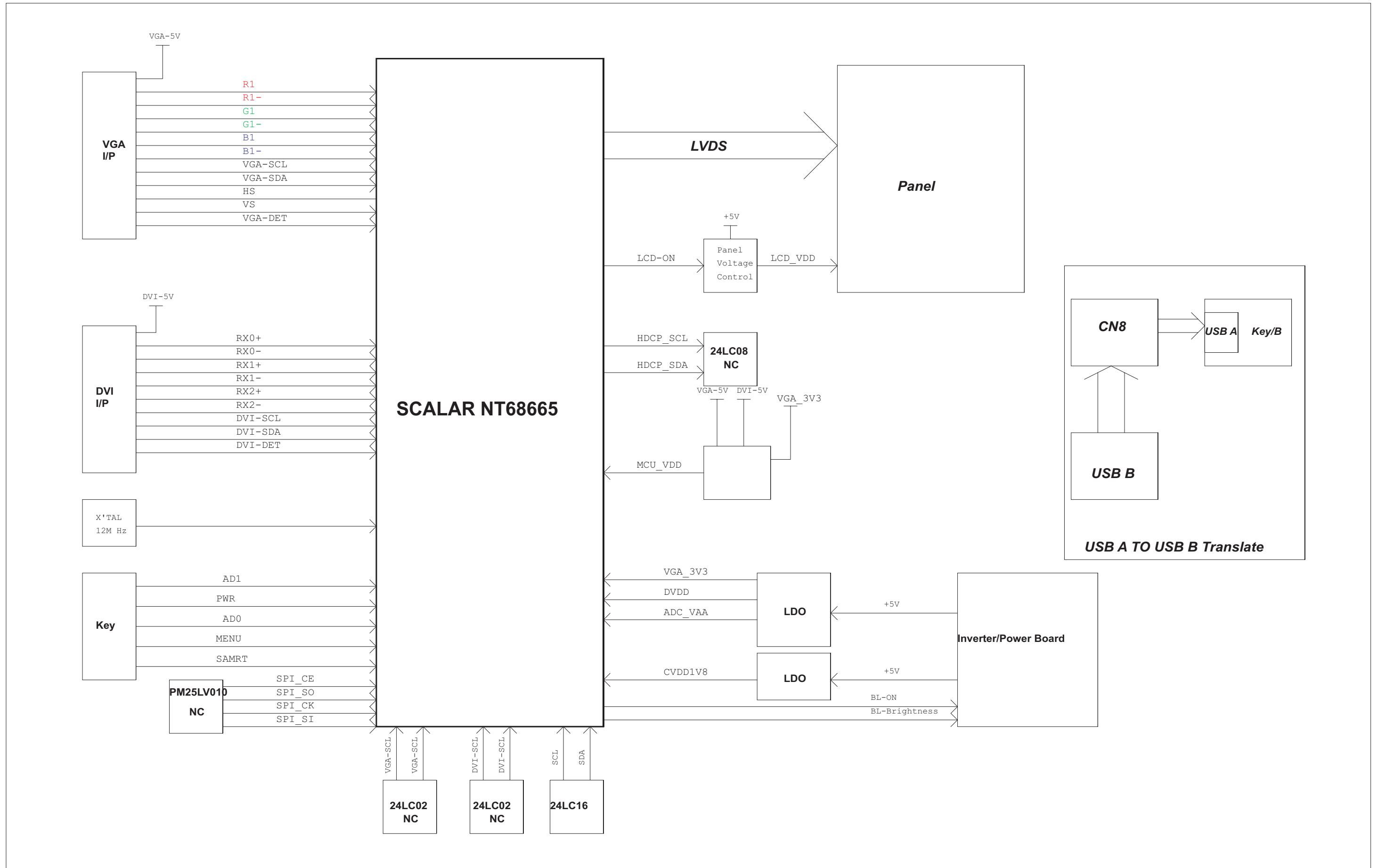

Schematic Diagram(Scaler Board - VGA Input)

S-A1

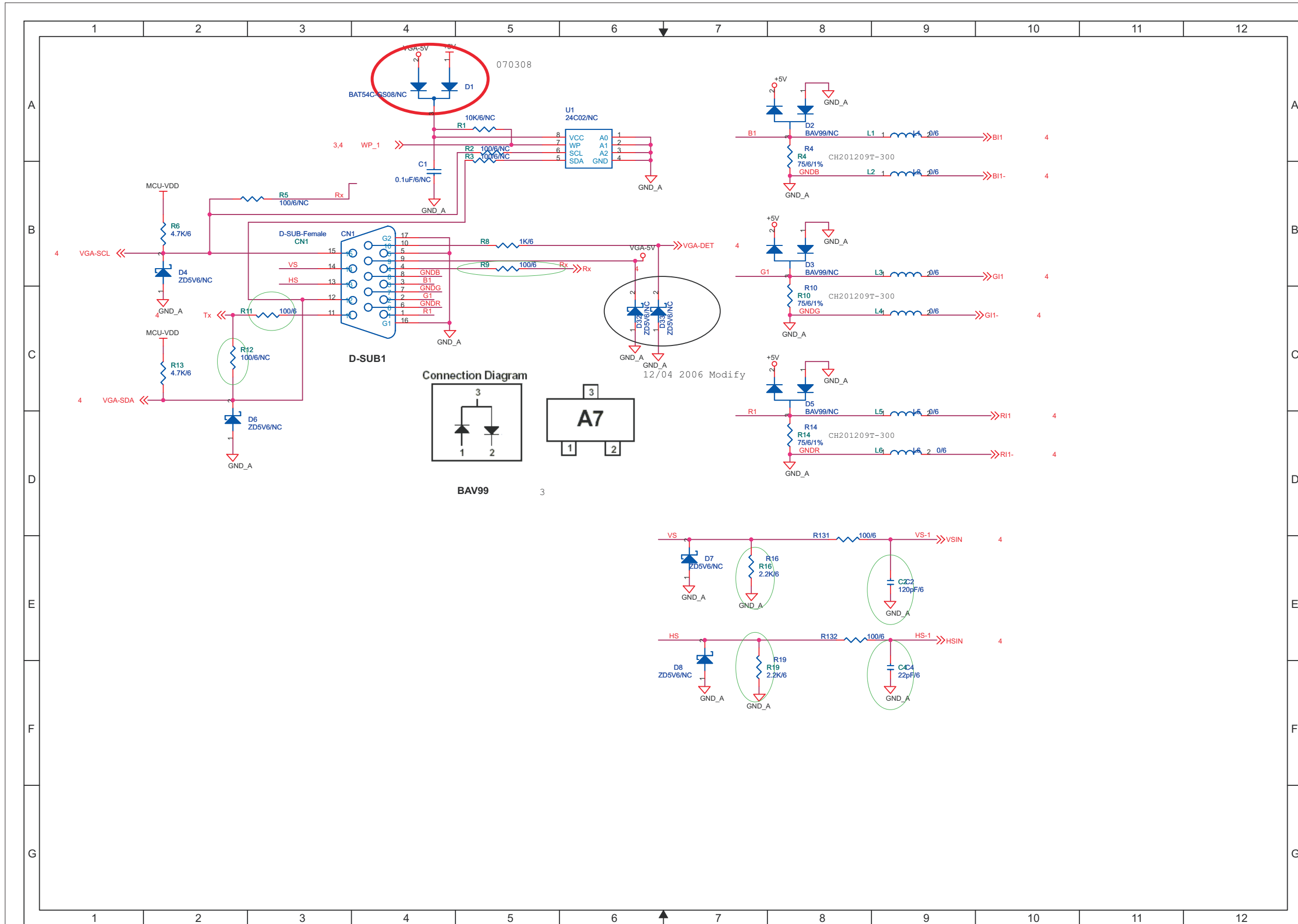

C1	B4
C2	E8
C4	E8
CN1	B3
D1	A4
D2	A7
D3	B7
D4	B2
D5	C7
D6	C2
D7	D7
D8	E7
D32	C6
D33	C6
L1	A8
L2	B8
L3	B8
L4	C8
L5	C8
L6	D9
R1	A5
R2	A5
R3	A5
R4	A7
R5	B2
R6	B2
R8	B5
R9	B5
R10	B7
R11	C3
R12	C2
R13	C2
R14	C7
R16	E7
R19	E7
R131	E8
R132	E8
U1	A5

S-A2

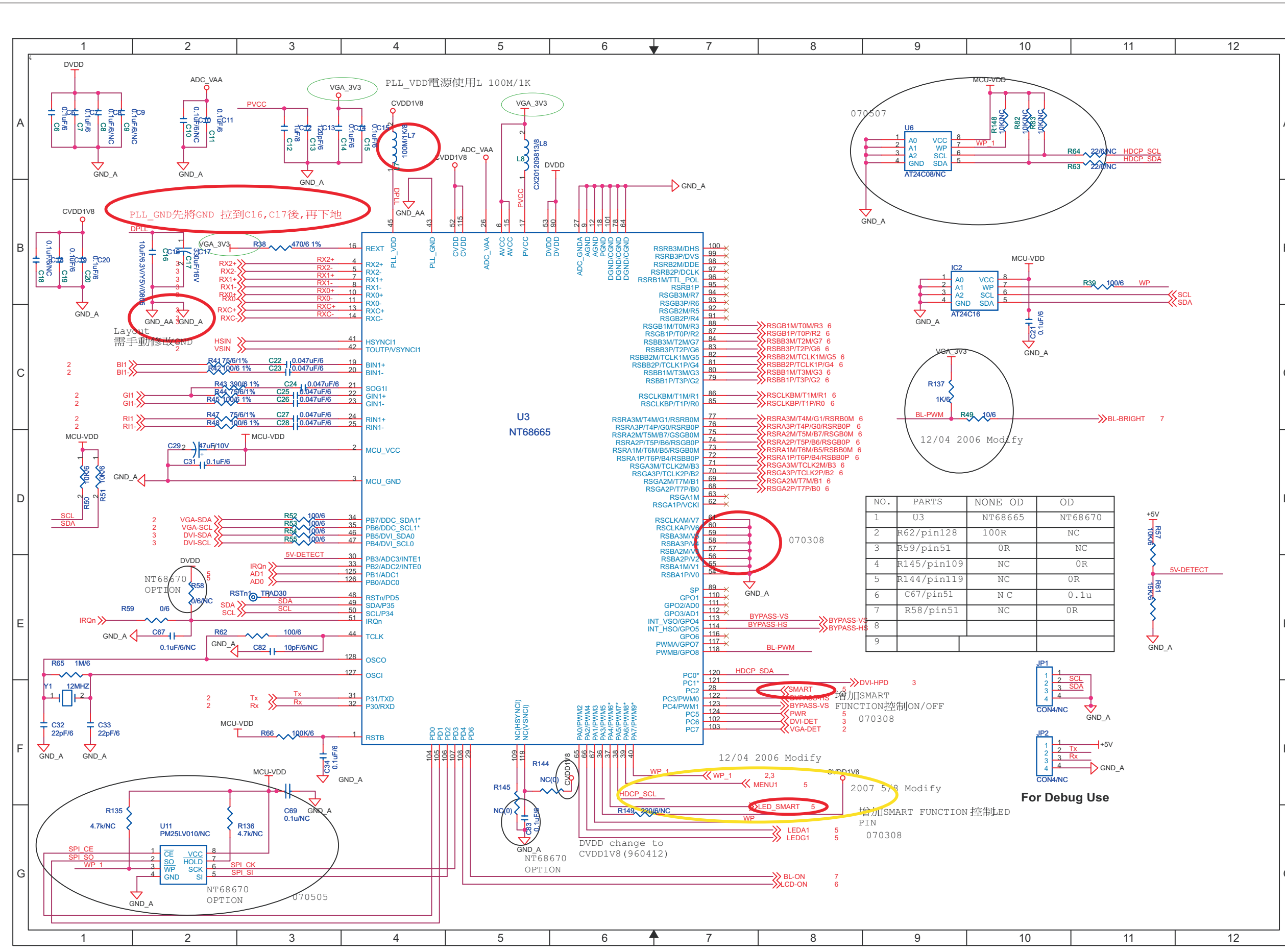

NO.	PARTS	NONE OD	OD
1	U3	NT68665	NT68670
2	R62/pin128	100R	NC
3	R59/pin51	0R	NC
4	R145/pin109	NC	0R
5	R144/pin119	NC	0R
6	C67/pin51	NC	0.1u
7	R58/pin51	NC	0R
8			
9			

- C6 A1 R39 B10
- C7 A1 R41 C2
- C8 A1 R42 C2
- C9 A1 R43 C2
- C10 A2 R44 C2
- C11 A2 R45 C2
- C12 A3 R47 C2
- C13 A3 R48 C2
- C14 A3 R49 C9
- C15 A4 R50 D1
- C16 B2 R51 D1
- C17 B2 R52 D3
- C18 B1 R53 D3
- C19 B1 R54 D3
- C20 B1 R55 D3
- C21 C10 R57 D11
- C22 C3 R58 E2
- C23 C3 R59 E2
- C24 C3 R61 E11
- C25 C3 R62 E3
- C26 C3 R63 A10
- C27 C3 R64 A10
- C28 C3 R65 E1
- C29 C2 R66 F3
- C31 D2 R82 A10
- C32 F1 R83 A10
- C33 F1 R135 F1
- C34 F3 R136 F2
- C67 E2 R137 C9
- C69 F3 R144 F5
- C82 E3 R145 F5
- C83 F5 R148 A10
- IC2 B9 R149 F6
- JP1 E10 RSTn1 E3
- JP2 F10 U11 G2
- L7 A4 U3 B4
- L8 A5 U6 A9
- R38 B3 Y1 E1

Schematic Diagram(Scaler Board - Key USB)

S-A3

- C70 B2
- C71 B2
- C72 B2
- C73 B3
- C74 B3
- C75 B3
- C84 B6
- C85 B6
- CN3 A1
- CN7 B1
- CN8 B8
- CN9 A8
- D20 D1
- D21 D2
- D22 D3
- D23 E1
- D24 E3
- D25 E4
- D37 D5
- Q1 C6
- Q2 C6
- Q6 D7
- R7 D7
- R15 D7
- R17 B2
- R18 B5
- R72 A6
- R73 A6
- R74 A5
- R75 A5
- R77 B5
- R79 B5
- R81 B5
- R90 B5
- R93 B2
- R94 B2
- R95 B5
- R141 B5
- R142 B5
- R143 A6

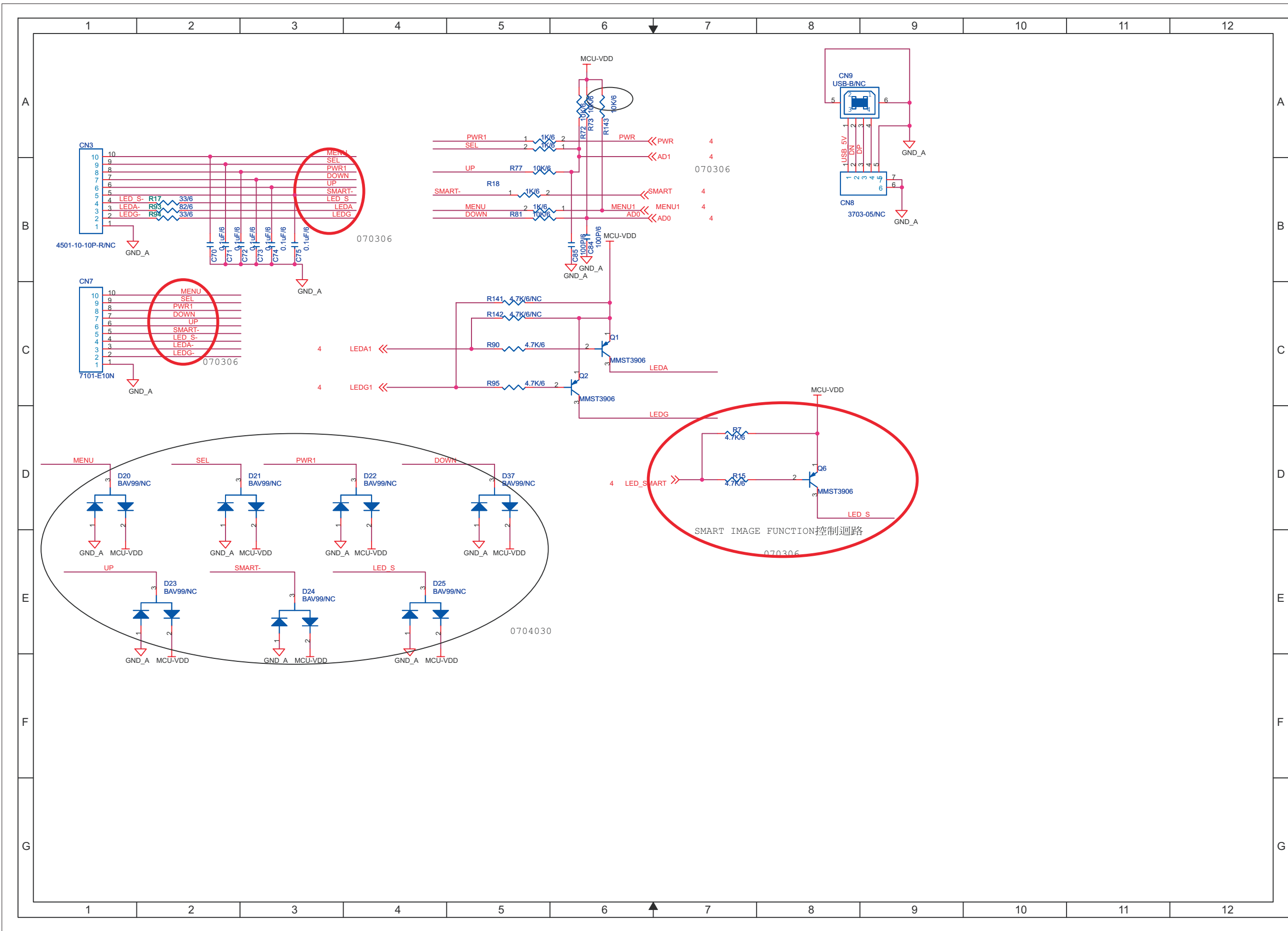

Schematic Diagram(Scaler Board - Power)

S-A5

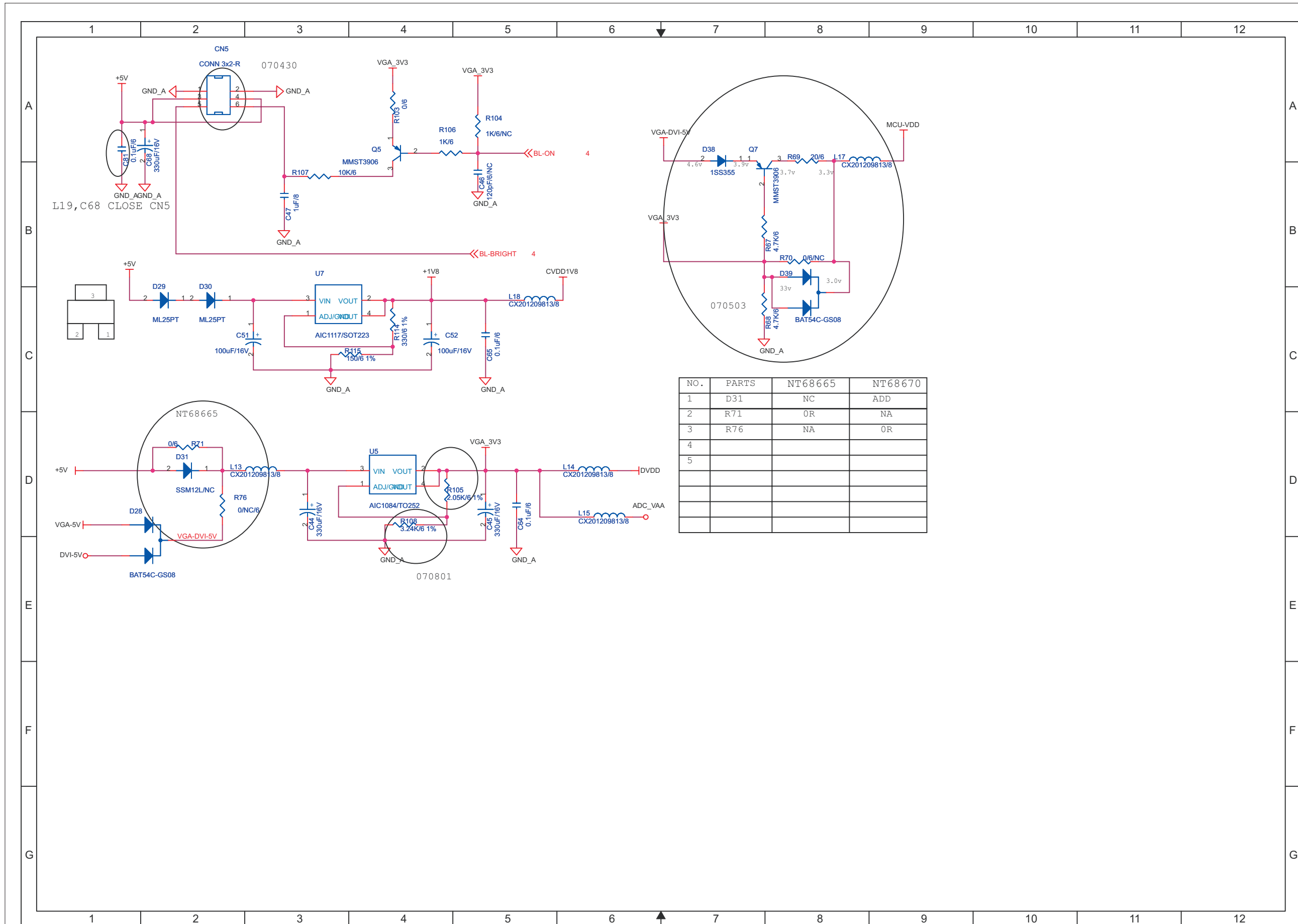

NO.	PARTS	NT68665	NT68670
1	D31	NC	ADD
2	R71	0R	NA
3	R76	NA	0R
4			
5			

- C44 D3
- C45 D5
- C46 B5
- C47 B3
- C51 C2
- C52 C4
- C64 D5
- C65 B5
- C68 A1
- C81 A1
- CN5 A2
- D28 D1
- D29 B2
- D30 B2
- D31 D2
- D38 A7
- D39 B8
- L13 D2
- L14 D6
- L15 D6
- L17 A8
- L18 B5
- Q5 A4
- Q7 A7
- R67 B7
- R68 B7
- R69 A8
- R70 B8
- R71 D2
- R76 D2
- R103 A4
- R104 A5
- R105 D4
- R106 A4
- R107 B3
- R108 D4
- R114 C4
- R115 C3
- U5 D4
- U7 B3

Schematic Diagram(Power Board)

P-A

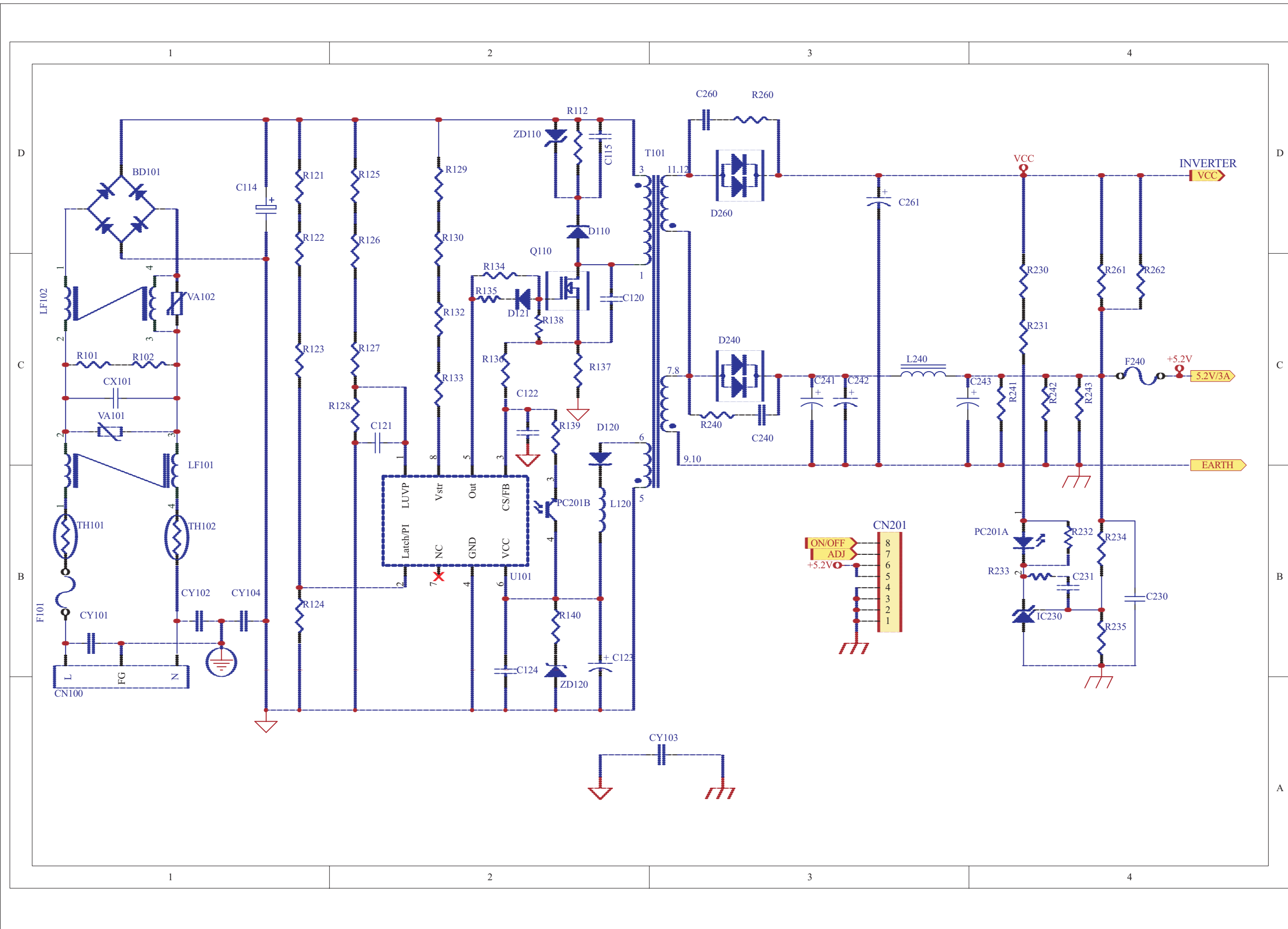

- BD101 D1
- C114 D1
- C115 D2
- C120 C2
- C121 C2
- C122 C2
- C123 B2
- C124 B2
- C230 B4
- C231 B4
- C240 C3
- C241 C3
- C242 C3
- C243 C4
- C260 D3
- C261 D3
- CN100 A1
- CN201 B3
- CX101 C1
- CY101 B1
- CY102 B1
- CY103 A3
- CY104 B1
- D110 D2
- D120 C2
- D121 C2
- D240 C3
- D260 D3
- F101 B1
- F101 B1
- F240 C4
- IC230 B4
- L120 B2
- L240 C3
- LF101 B1
- LF101 C1
- LF102 C1
- PC201A B4
- PC201B B2
- Q110 D2
- R101 C1
- R102 C1
- R112 D2
- R121 D1
- R122 D1
- R125 D2
- R126 D2
- R127 C2
- R129 D2
- R130 D2
- R132 C2
- R133 C2
- R134 C2
- R135 C2
- R136 C2
- R138 C2
- R139 C2
- R140 B2
- R140 B2
- R230 C4
- R231 C4
- R232 B4
- R233 B4
- R234 B4
- R235 B4
- R240 C3
- R241 C4
- R242 C4
- R243 C4
- R260 D3
- R261 C4
- R262 C4
- TH101 B1
- TH102 B1
- U101 B2
- VA101 C1
- VA102 C1

Schematic Diagram(Power Board)

P-B

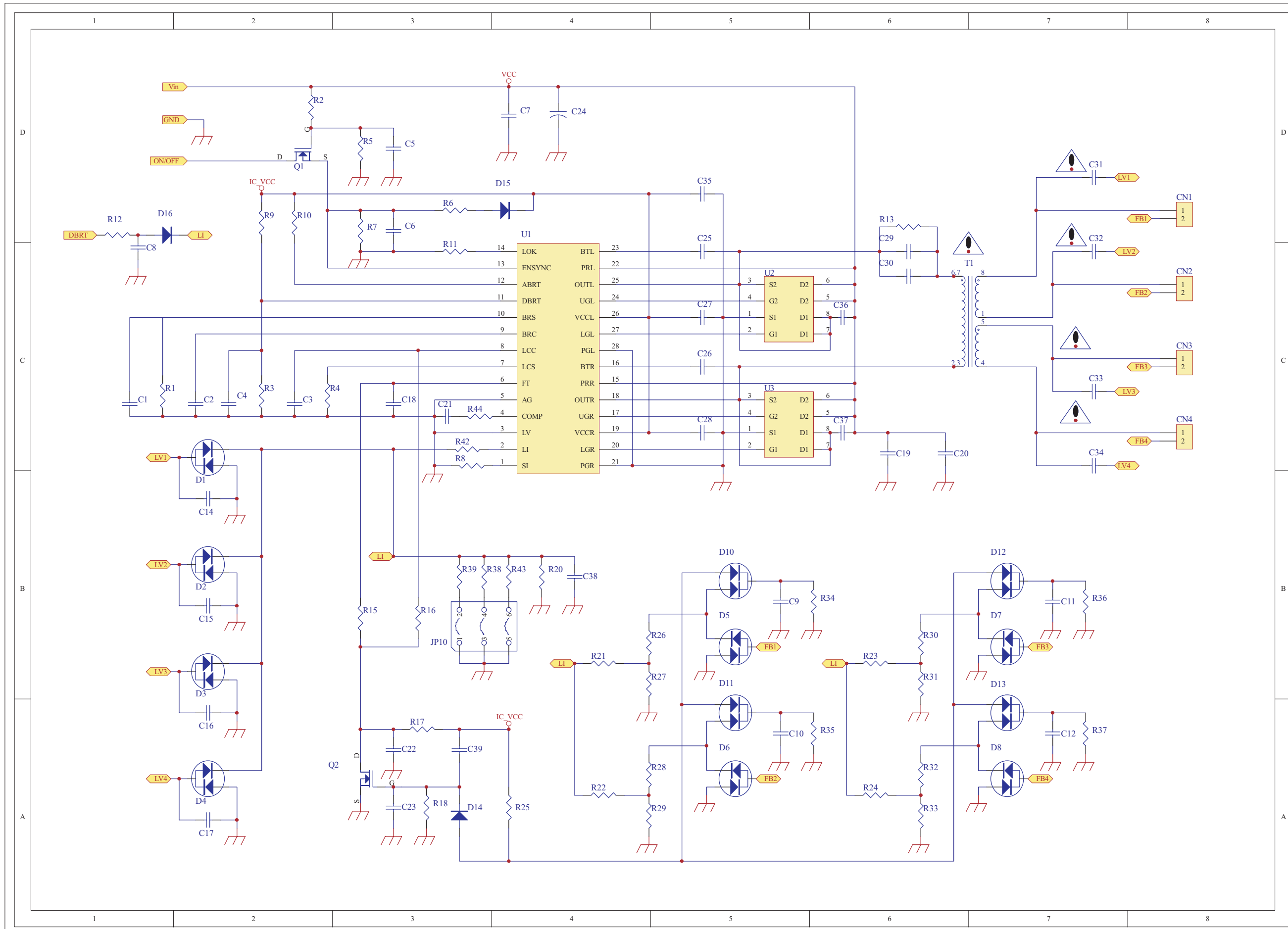

C1	C1	FB4	A7
C2	C2	FB4	C8
C3	C2	JP10	B3
C4	C2	L1	D2
C5	D3	L1	B3
C6	D3	L1	B4
C7	D4	L1	B6
C8	C1	LV1	C1
C9	B5	LV1	D8
C10	A5	LV2	B1
C11	B7	LV2	C8
C12	A7	LV3	B1
C14	B2	LV3	C8
C15	B2	LV4	A1
C16	A2	LV4	C8
C17	A2	Q1	D2
C18	C3	Q2	A3
C19	C6	R1	C1
C20	C6	R1	C2
C21	C3	R2	D2
C22	A3	R3	C2
C23	A3	R4	C3
C24	D4	R5	D3
C25	D5	R6	D3
C26	C5	R7	D3
C27	C5	R8	C3
C28	C5	R9	D2
C29	D6	R10	D2
C30	C6	R11	C3
C31	D7	R11	D3
C32	D7	R12	D1
C33	C7	R13	D6
C34	C7	R15	B3
C35	D5	R16	B3
C36	C6	R17	A3
C37	C6	R18	A3
C38	B4	R20	B4
C39	A3	R21	B4
CN1	D8	R22	A4
CN2	C8	R23	B6
CN3	C8	R24	A6
CN4	C8	R25	A4
D10	B5	R26	B5
D11	B5	R27	B5
D12	B7	R28	A5
D13	B7	R29	A5
D14	A3	R30	B6
D15	D4	R31	B6
D16	D1	R32	A6
D16	B2	R33	A6
D2	B2	R34	B6
D3	B2	R35	A6
D4	A2	R36	B7
D5	B5	R37	A7
D6	A5	R38	B4
D7	B7	R39	B3
D8	A7	R42	C3
FB1	B5	R43	B4
FB1	D8	R44	C3
FB2	A5	T1	C7
FB2	C8	U1	D4
FB3	B7	U2	C5
FB3	C8	U3	C5

Schematic Diagram(Button Board)

B-1

CON1	C2
LED1	E5
SW1	D5
SW3	D5
SW4	D5
SW6	D5
LED2	D5
SW2	C5
SW5	C5

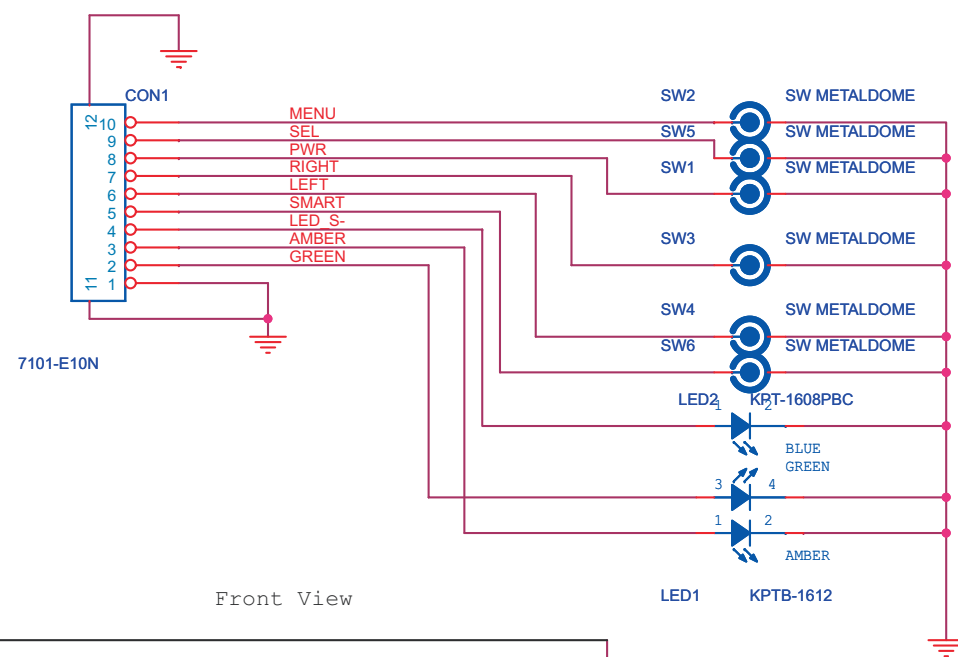

Front View

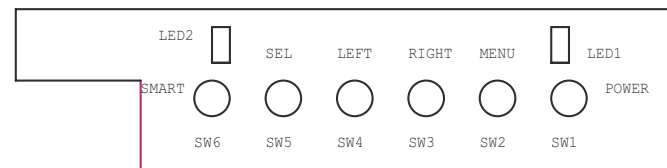

Layout Side View (Scaler Board)

S-A

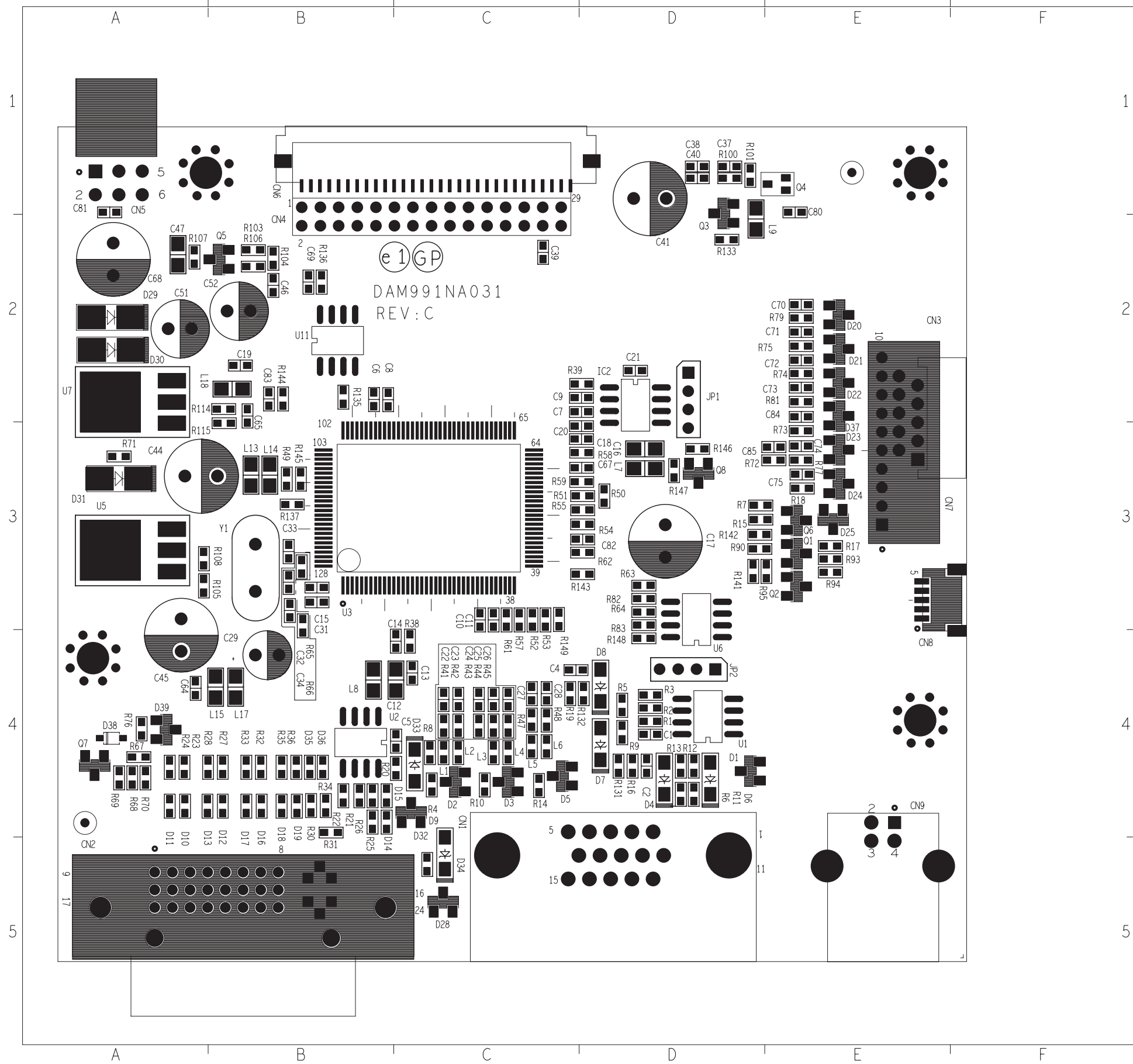

C1	D4	CN1	C4	Q2	E3	R62	D3
C2	D4	CN2	A5	Q3	D2	R63	D3
C4	C4	CN3	E2	Q4	E1	R64	D3
C5	C4	CN4	B2	Q5	B2	R65	B4
C6	B2	CN5	A1	Q6	E3	R66	B4
C7	C2	CN6	B1	Q7	A4	R67	A4
C8	B2	CN7	E3	Q8	D3	R68	A4
C9	C2	CN8	E4	R1	D4	R69	A4
C10	C3	CN9	E4	R2	D4	R70	A4
C11	C3	D1	D4	R3	D4	R71	A3
C12	B4	D2	C4	R4	C4	R72	D3
C13	C4	D3	C4	R5	D4	R72	D3
C14	C3	D4	D4	R6	D4	R73	E3
C15	B3	D5	C4	R8	C4	R74	E2
C16	D3	D6	D4	R9	D4	R75	E2
C17	D3	D7	D4	R10	C4	R76	A4
C18	D3	D8	D4	R11	D4	R77	E3
C19	B2	D9	C4	R12	D4	R79	E2
C20	C3	D12	B5	R13	D4	R81	E2
C21	D2	D13	B5	R14	C4	R82	D3
C22	C4	D14	B5	R15	D3	R83	D3
C23	C4	D15	C4	R16	D4	R90	D3
C24	C4	D16	B5	R17	E3	R93	E3
C25	C4	D17	B5	R18	E3	R94	E3
C26	C4	D18	B4	R19	C4	R95	D3
C27	C4	D19	B4	R20	B4	R95	E3
C28	C4	D20	E2	R21	B4	R100	D1
C29	B4	D21	E2	R22	B4	R101	D1
C31	B3	D22	E2	R23	A4	R103	B2
C31	B4	D23	E3	R24	A4	R104	B2
C32	B4	D24	E3	R25	B5	R105	B3
C33	B3	D25	E3	R26	B4	R106	B2
C34	B4	D28	C5	R27	B4	R107	A2
C37	D1	D29	A2	R28	B4	R108	B3
C38	D1	D30	A2	R30	B4	R114	A2
C39	C2	D31	A3	R31	B5	R115	A3
C40	D1	D32	C5	R32	B4	R131	D4
C41	D2	D33	C4	R33	B4	R132	D4
C44	A3	D34	C5	R34	B4	R133	D2
C45	A4	D35	B4	R35	B4	R135	B2
C46	B2	D36	B4	R36	B4	R136	B2
C47	A2	D37	E3	R38	C3	R137	B3
C51	A2	D38	A4	R39	C2	R141	D3
C52	B2	D39	A4	R41	C4	R142	D3
C64	A4	IC2	D2	R42	C4	R143	C3
C65	B2	JP1	D2	R43	C4	R143	D3
C67	D3	JP2	D4	R44	C4	R144	B2
C68	A2	L2	C4	R45	C4	R145	B3
C69	B2	L3	C4	R47	C4	R146	D3
C70	E2	L4	C4	R48	C4	R147	D3
C71	E2	L5	C4	R49	B3	R148	D4
C72	E2	L6	C4	R50	D3	R149	C4
C73	E2	L7	D3	R51	C3	U11	B2
C74	E3	L8	B4	R52	C4	U11	D4
C75	E3	L9	E2	R53	C4	U2	B4
C80	E1	L13	B3	R54	D3	U3	B3
C81	A1	L14	B3	R55	C3	U5	A3
C82	D3	L15	B4	R57	C4	U6	D4
C83	B2	L17	B4	R58	D3	U7	A2
C84	E2	L18	A2	R59	C3	Y1	B3
C85	D3	Q1	E3	R61	C4		

Layout Side View (Scaler Board)

S-B

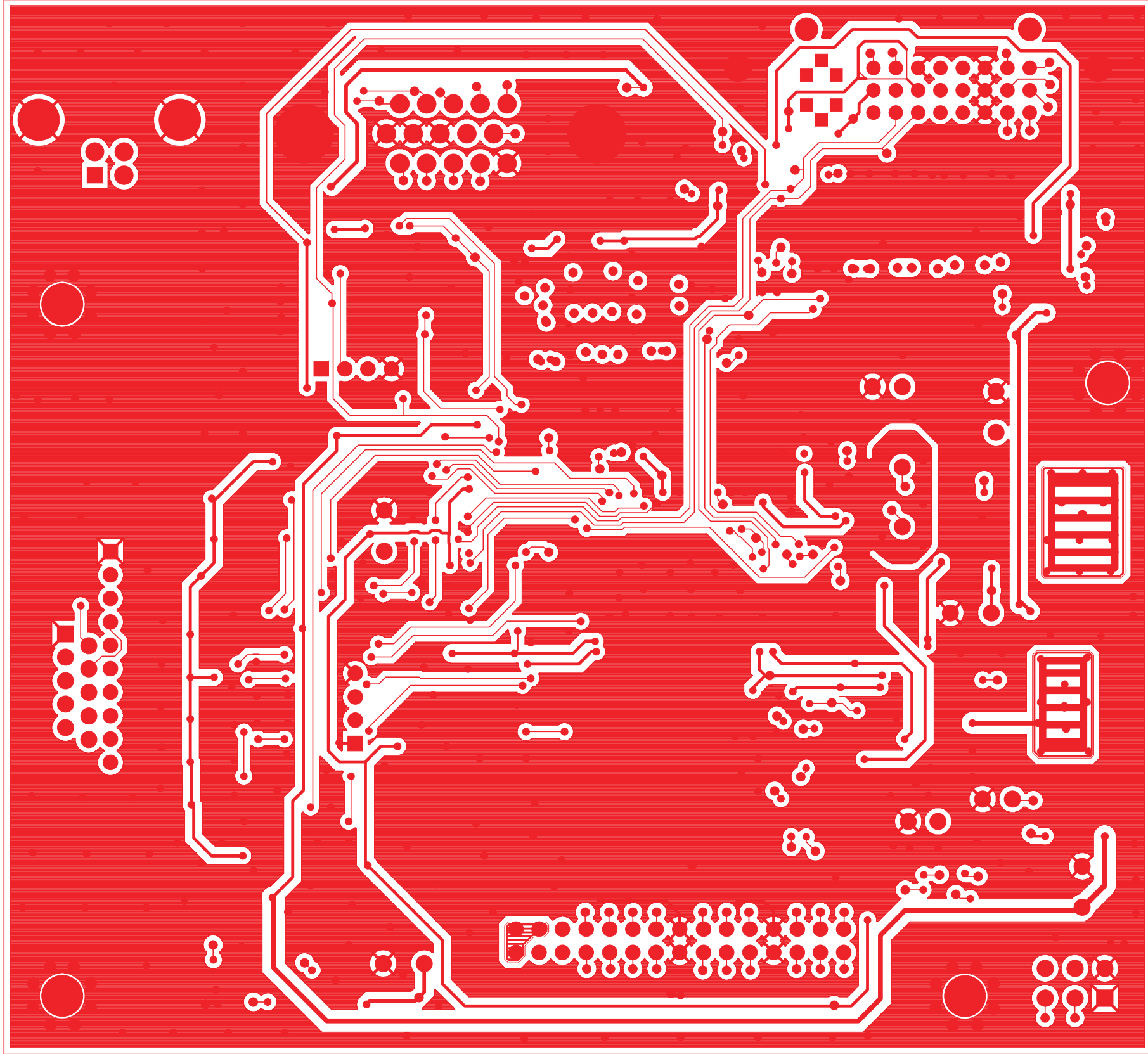

Layout Side View (Power Board)

P-A

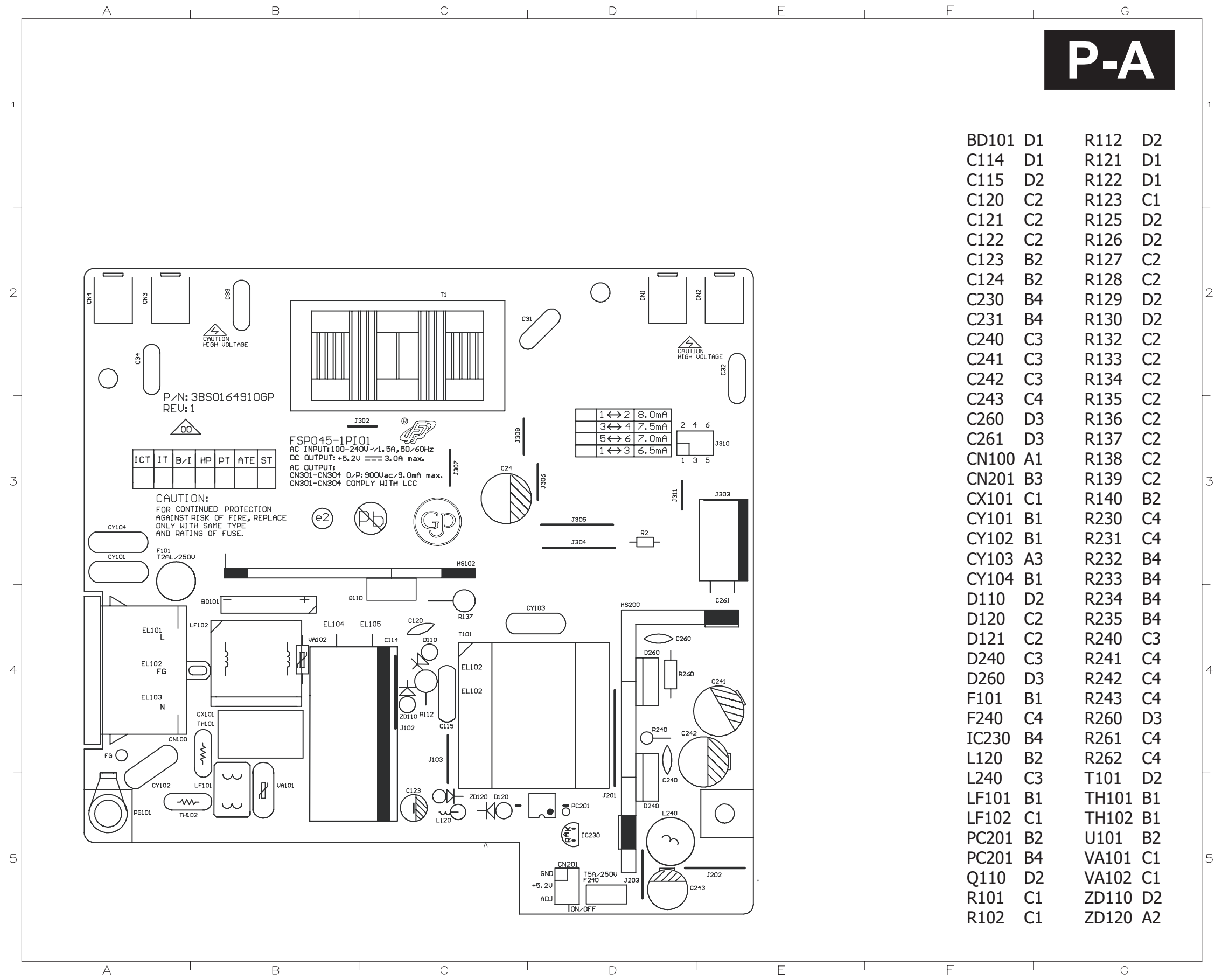

BD101	D1	R112	D2
C114	D1	R121	D1
C115	D2	R122	D1
C120	C2	R123	C1
C121	C2	R125	D2
C122	C2	R126	D2
C123	B2	R127	C2
C124	B2	R128	C2
C230	B4	R129	D2
C231	B4	R130	D2
C240	C3	R132	C2
C241	C3	R133	C2
C242	C3	R134	C2
C243	C4	R135	C2
C260	D3	R136	C2
C261	D3	R137	C2
CN100	A1	R138	C2
CN201	B3	R139	C2
CX101	C1	R140	B2
CY101	B1	R230	C4
CY102	B1	R231	C4
CY103	A3	R232	B4
CY104	B1	R233	B4
D110	D2	R234	B4
D120	C2	R235	B4
D240	C3	R240	C3
D260	D3	R241	C4
F101	B1	R242	C4
F240	C4	R243	C4
IC230	B4	R260	D3
L120	B2	R261	C4
L240	C3	R262	C4
LF101	B1	T101	D2
LF102	C1	TH101	B1
PC201	B2	TH102	B1
PC201	B4	U101	B2
Q110	D2	VA101	C1
R101	C1	VA102	C1
R102	C1	ZD110	D2
		ZD120	A2

Layout Side View (Power Board)

P-B

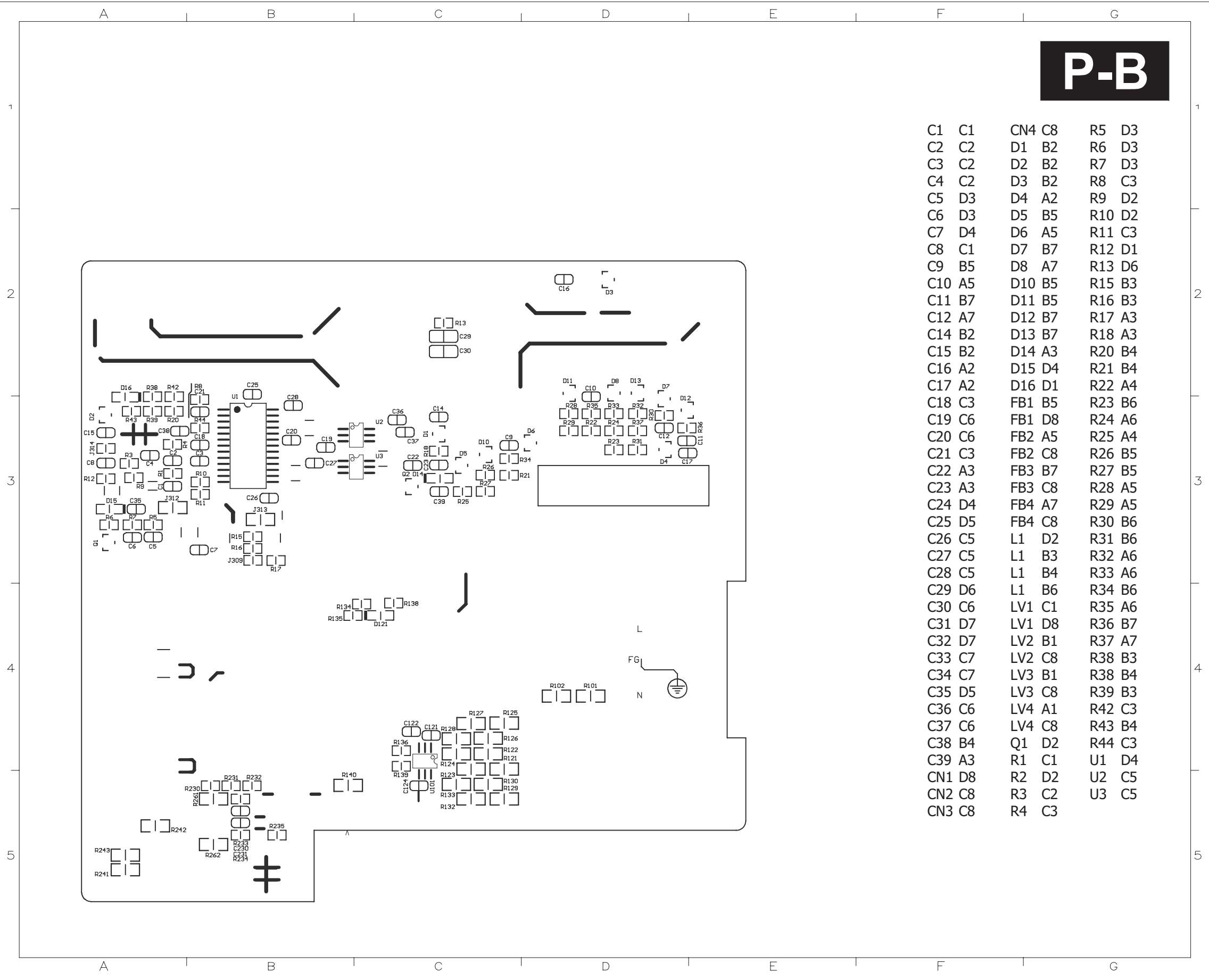

C1	C1	CN4	C8	R5	D3
C2	C2	D1	B2	R6	D3
C3	C2	D2	B2	R7	D3
C4	C2	D3	B2	R8	C3
C5	D3	D4	A2	R9	D2
C6	D3	D5	B5	R10	D2
C7	D4	D6	A5	R11	C3
C8	C1	D7	B7	R12	D1
C9	B5	D8	A7	R13	D6
C10	A5	D10	B5	R15	B3
C11	B7	D11	B5	R16	B3
C12	A7	D12	B7	R17	A3
C14	B2	D13	B7	R18	A3
C15	B2	D14	A3	R20	B4
C16	A2	D15	D4	R21	B4
C17	A2	D16	D1	R22	A4
C18	C3	FB1	B5	R23	B6
C19	C6	FB1	D8	R24	A6
C20	C6	FB2	A5	R25	A4
C21	C3	FB2	C8	R26	B5
C22	A3	FB3	B7	R27	B5
C23	A3	FB3	C8	R28	A5
C24	D4	FB4	A7	R29	A5
C25	D5	FB4	C8	R30	B6
C26	C5	L1	D2	R31	B6
C27	C5	L1	B3	R32	A6
C28	C5	L1	B4	R33	A6
C29	D6	L1	B6	R34	B6
C30	C6	LV1	C1	R35	A6
C31	D7	LV1	D8	R36	B7
C32	D7	LV2	B1	R37	A7
C33	C7	LV2	C8	R38	B3
C34	C7	LV3	B1	R38	B4
C35	D5	LV3	C8	R39	B3
C36	C6	LV4	A1	R42	C3
C37	C6	LV4	C8	R43	B4
C38	B4	Q1	D2	R44	C3
C39	A3	R1	C1	U1	D4
CN1	D8	R2	D2	U2	C5
CN2	C8	R3	C2	U3	C5
CN3	C8	R4	C3		

Layout Side View (Button Board)

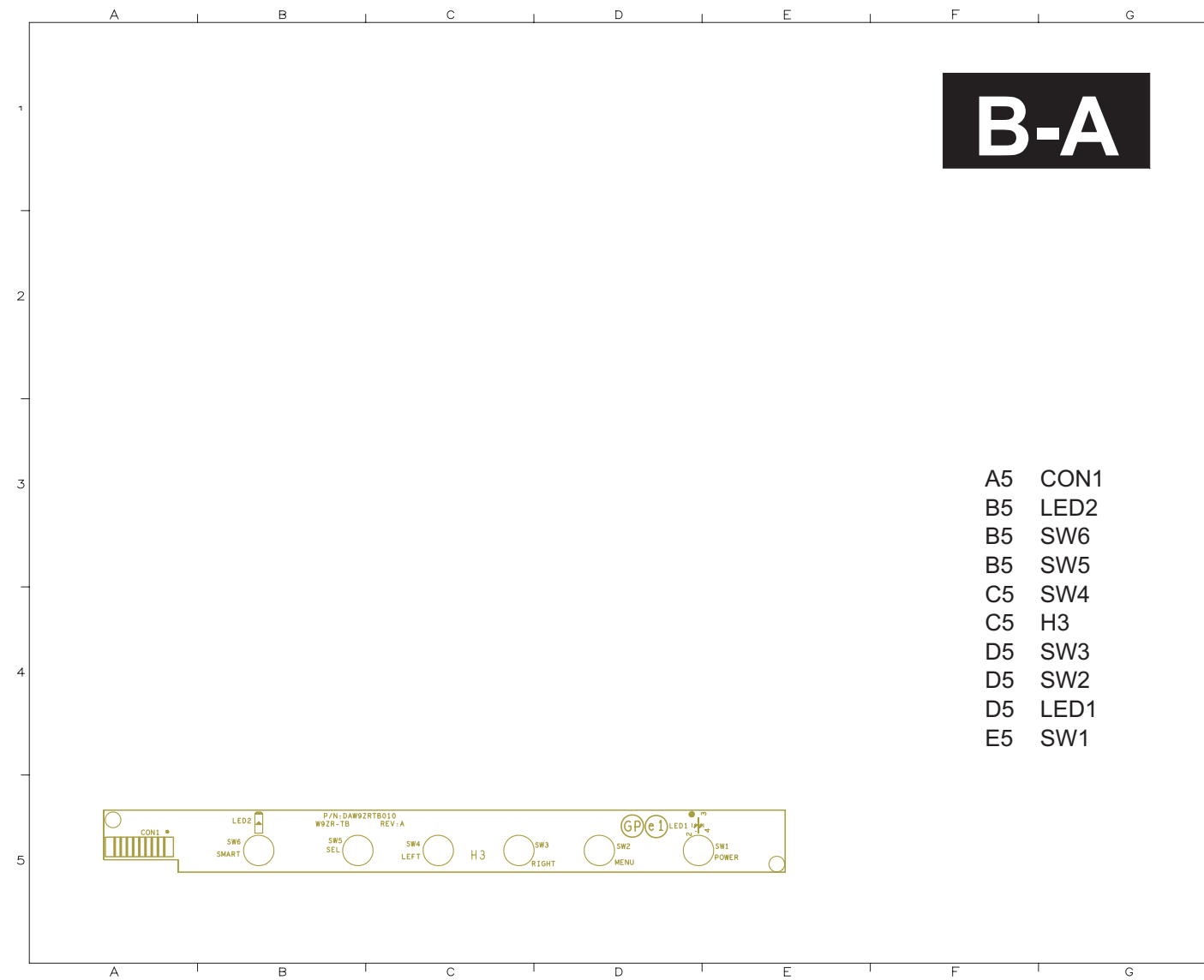

B-B



Exploded View

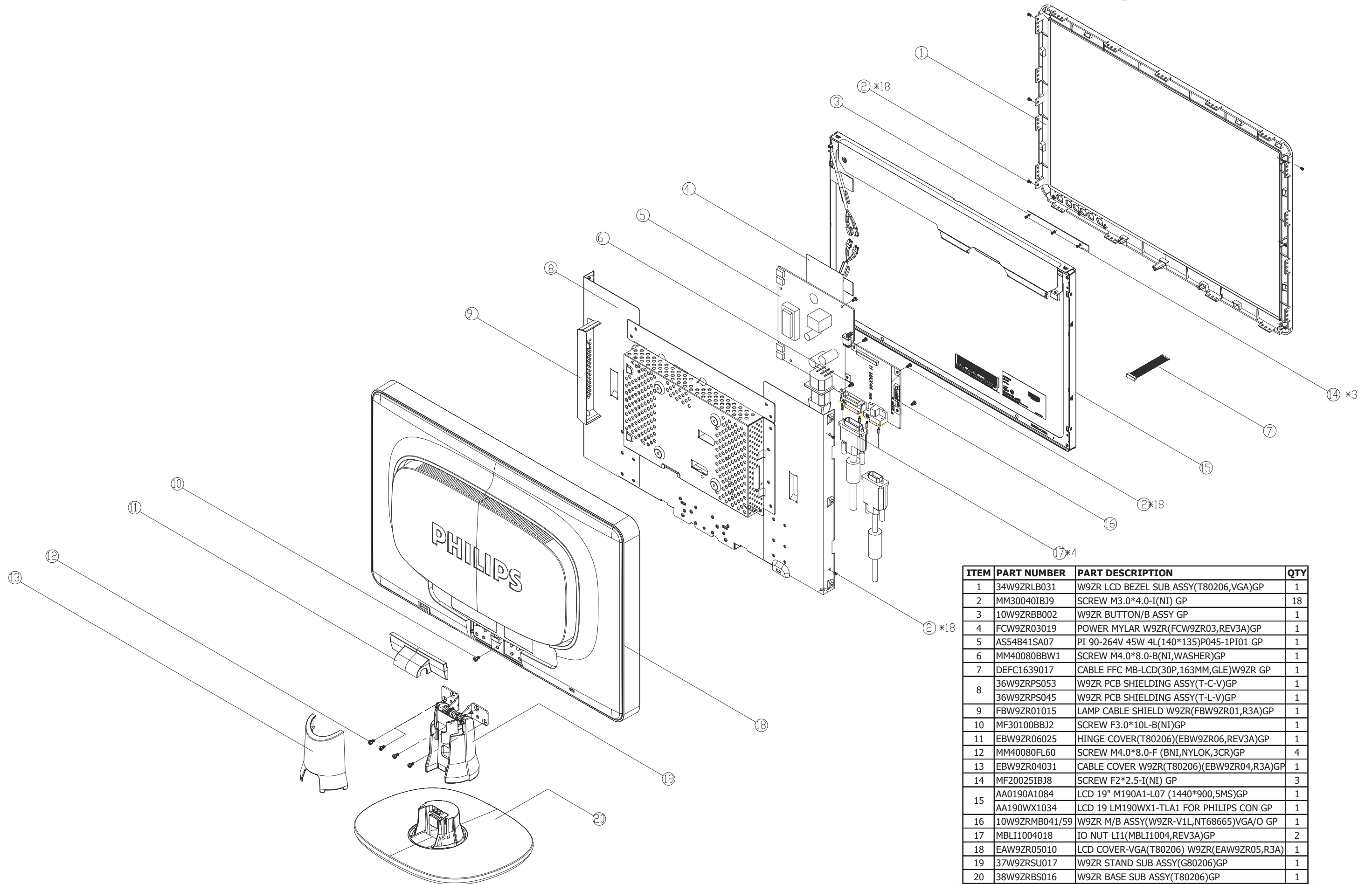

ITEM	PART NUMBER	PART DESCRIPTION	QTY
1	34W9ZRLB031	W9ZR LCD BEZEL SUB ASSY(T80206,VGA)GP	1
2	MM30040IBJ9	SCREW M3.0*4.0-I(NI) GP	18
3	10W9ZRB002	W9ZR BUTTON/B ASSY GP	1
4	FCW9ZR03019	POWER MYLAR W9ZR(FCW9ZR03,REV3A)GP	1
5	AS54B41SA07	PI 90-264V 45W 4L(140*135)P045-1PI01 GP	1
6	MM40080BBW1	SCREW M4.0*8.0-B(NI,WASHER)GP	1
7	DEFC1639017	CABLE FFC MB-LCD(30P,163MM,GLE)W9ZR GP	1
8	36W9ZRPS053	W9ZR PCB SHIELDING ASSY(T-C-V)GP	1
	36W9ZRPS045	W9ZR PCB SHIELDING ASSY(T-L-V)GP	1
9	FBW9ZR01015	LAMP CABLE SHIELD W9ZR(FBW9ZR01,R3A)GP	1
10	MF30100BBJ2	SCREW F3.0*10L-B(NI)GP	1
11	EBW9ZR06025	HINGE COVER(T80206)(EBW9ZR06,REV3A)GP	1
12	MM40080FL60	SCREW M4.0*8.0-F (BNI,NYLOK,3CR)GP	4
13	EBW9ZR04031	CABLE COVER W9ZR(T80206)(EBW9ZR04,R3A)GP	1
14	MF20025IBJ8	SCREW F2*2.5-I(NI) GP	3
15	AA0190A1084	LCD 19" M190A1-L07 (1440*900,5MS)GP	1
	AA190WX1034	LCD 19 LM190WX1-TLA1 FOR PHILIPS CON GP	1
16	10W9ZRM041/59	W9ZR M/B ASSY(W9ZR-V1L,NT68665)VGA/O GP	1
17	MBLI1004018	IO NUT LI1(MBLI1004,REV3A)GP	2
18	EAW9ZR05010	LCD COVER-VGA(T80206) W9ZR(EAW9ZR05,R3A)	1
19	37W9ZRSU017	W9ZR STAND SUB ASSY(G80206)GP	1
20	38W9ZRBS016	W9ZR BASE SUB ASSY(T80206)GP	1

Recommended Spare Part List

190VW8 LCD

37

RSPL FOR 190VW8FB/93/(W9ZR-V1L)
1 P/N: 1W9ZRVPL011(LPL PANEL)

Part Name	Philips P/N	Techview P/N	Description	Q'ty	Location	Remark	
Electronic Components:	LCD panel	996510007665	AA190WX1034	LCD 19 LM190WX1-TLA1 FOR PHILIPS CON GP	1	Item 15 in exploded view	LPL PANEL
	MB-LCD cable	996510007666	DEFC1639017	CABLE FFC MB-LCD(30P,163MM,GLE)W9ZR GP	1	Item 7 in exploded view	
	MB-LCD cable	996510007667	DEFC1639025	CABLE FFC MB-LCD(30P,163MM)W9ZR PTI GP	1		2nd source
	MB-BB Cable		DEFC4529026	CABLE FFC MB-BB(10P/10P,452MM)W9ZR PTI	1		
	MB-BB Cable		DEFC4529034	CABLE FFC MB-BB(10P/10P,452MM)W9ZR GLE	1		2nd source
	IC	996510007639	AJ68665*F04	IC(128P)NT68665MFG-128(165MHZ,QFP) GP	1	U3	VGA,DVI signal dealer
	IC	996510007622	AKE10800018	IC EEPROM(8P)24BC16-SI(2048*8,SOIC8) GP	1	IC2	Store timing table, HDCP information
	IC	996500044124	AKE10800R01	IC EEPROM(8P) BR24L16F-WE2(2K*8,SOP8)GP	1	IC2	Store timing table, HDCP information
	IC	996500044125	AKE3A8S0Y10	IC EEPROM(8P)24LC16BT-I(2K*8,100KHZ) GP	1	IC2	Store timing table, HDCP information
	IC	996500045091	AL001084021	IC(3P) AIC1084PE(TO-252) GP	1	U5	Power translation, scaler IC power supply.
	IC	996500045092	AL001084099	IC(3P)SMD AP1084DLA(TO-252) GP	1	U5	Power translation, scaler IC power supply.
	IC	996510007624	AL001117086	IC(3P) AIC1117PY(SOT-223) GP	1	U7	Power translation, scaler IC power supply.
	IC	996510007625	AL1117EL100	IC(3P) ATC AP1117EL-13(SOT-223) GP	1	U7	Power translation, scaler IC power supply.
	TRANSISTOR	996510007626	BA001440Z87	TRANSISTOR SMD PDTC144EU (50V,30MA)GP	1	Q4	
	TRANSISTOR	996500044115	BA001440ZB8	TR CHDTC144EUPT(50V,30MA)SOT-323 GP	1	Q4	
	TRANSISTOR	996510007627	BA001520Z05	TR CHDTC152EUPT(50V,70MA)SOT-323 GP	1	Q4	
	TRANSISTOR	996510007628	BA039060013	TR SMD MMBT3906LT1G(40V,200MA) GP	5	Q1,Q2,Q5,Q6,Q7	
TRANSISTOR	996500044110	BA039060Z10	TR,SMD PMBS3906(40V,200MA) GP	5	Q1,Q2,Q5,Q6,Q7		
TRANSISTOR	996510002084	BA039060Z28	TRANSISTOR,SMD SST3906(40V,200MA) GP	5	Q1,Q2,Q5,Q6,Q7		
TRANSISTOR	996510007629	BAM34150Z08	TR MOSFET AO3415(-20V,-4A)SOT-23 GP	1	Q3		
Mechanical Components:	Stand	996510007632	37W9ZRSU017	W9ZR STAND SUB ASSY(G80206)GP	1	Item 19 in exploded view	
	DVI&D-SUB to shielding		MBL11004018	IO NUT L11(MBL11004,REV3A)GP	2	Item 17 in exploded view	
	PCBAs to metal shielding		MM30040IBJ9	SCREW M3.0*4.0-(NI) GP	12	Item 2 in exploded view	
	Panel to L/R bracket		MM30040IBJ9	SCREW M3.0*4.0-(NI) GP	6	Item 2 in exploded view	
	Hinge Cover	996510007633	EBW9ZR06025	HINGE COVER(T80206)(EBW9ZR06,REV3A)GP	1	Item 11 in exploded view	
	Base	996510007634	38W9ZRBS016	W9ZR BASE SUB ASSY(T80206)GP	1	Item 20 in exploded view	
PCBA:	Power Board	996510007671	AS54B41SA07	PI 90-264V 45W 4L(140*135)P045-1PI01 GP	1	Item 5 in exploded view	
	Main Board	996510009170	10W9ZRMBO41	W9ZR M/B ASSY(W9ZR-V1L,NT68665)VGA/O GF	1	Item 16 in exploded view	21W9ZRMBO50
	Bios		AZW9ZRBL015	W9ZR-V1L SW BIOS (NT68665)LPL	1		
	Button Board	996510007673	10W9ZRBB002	W9ZR BUTTON/B ASSY GP	1	Item 3 in exploded view	23W9ZRBB005
Cabinets:	Front Bezel Assembly	996510009171	34W9ZRLB031	W9ZR LCD BEZEL SUB ASSY(T80206,VGA)GP	1	Item 1 in exploded view	
	Back Cover Assembly	996510009172	EAW9ZR05010	LCD COVER-VGA(T80206) W9ZR(EAW9ZR05,R3A)	1	Item 18 in exploded view	
Accessories:	VGA cable	996510007677	DDW9ZRPC009	CABLE VGA BLACK(15/15P 1.8M)W9ZRGF	1		
	Power Cord	996500044139	DM333181S01	POWER CORD B 1.8M SP-506/10A (CHN) GP	1		
	Manual		HGW9ZR03012	QSG+CD W9ZR-V1(HGW9ZR03,R3A)GP	1		
	LCD film		JXW9VA01014	LCD FILM 430*285 W9VA-A4(JXW9VA01,R3A)GF	1		
Packing Material:	EPE bag		HAW9ZR01014	EPE BAG W9ZR(HAW9ZR01,R3A)GP	1		
	Carton	996510009173	HFW9ZR07017	CARTON W9ZR-V1(HFW9ZR07,R3A)CN_GP	1		
	Cushion-L	996510007680	HBW9ZR01015	END CAP-L W9ZR-C1/S1(HBW9ZR01,REV3A)GP	1		
	Cushion-R	996510007652	HBW9ZR02011	END CAP-R W9ZR-C1/S1(HBW9ZR02,REV3A)GF	1		
	Cushion-T	996510009174	HBW9ZR03018	END CAP-T W9ZR-C1/S1(HBW9ZR03,REV3A)GF	1		

38 **190VW8 LCD** **Recommended Spare Part List**

RSPL FOR 190VW8FB/93(W9ZR-V1M)
1 P/N: 1W9ZRVPL002(CMO PANEL)

Part Name	Philips P/N	Techview P/N	Description	Q'ty	Location	Remark	
Electronic Components:	LCD panel	996510007631	AA0190A1084	LCD 19" M190A1-L07 (1440*900,5MS)GP	1	Item 15 in exploded view	CMO PANEL
	MB-LCD cable	996510007666	DEFC1639017	CABLE FFC MB-LCD(30P,163MM,GLE)W9ZR GP	1	Item 7 in exploded view	
	MB-LCD cable	996510007667	DEFC1639025	CABLE FFC MB-LCD(30P,163MM)W9ZR PTI GP	1		2nd source
	MB-BB Cable		DEFC4529026	CABLE FFC MB-BB(10P/10P,452MM)W9ZR PTI	1		
	MB-BB Cable		DEFC4529034	CABLE FFC MB-BB(10P/10P,452MM)W9ZR GLE	1		2nd source
	IC	996510007639	AJ68665*F04	IC(128P)NT68665MFG-128(165MHZ,QFP) GP	1	U3	VGA,DVI signal dealer
	IC	996510007622	AKE10800018	IC EEPROM(8P)24BC16-SI(2048*8,SOIC8) GP	1	IC2	Store timing table, HDCP information
	IC	996500044124	AKE10800R01	IC EEPROM(8P) BR24L16F-WE2(2K*8,SOP8)GP	1	IC2	Store timing table, HDCP information
	IC	996500044125	AKE3A8S0Y10	IC EEPROM(8P)24LC16BT-I(2K*8,100KHZ) GP	1	IC2	Store timing table, HDCP information
	IC	996500045091	AL001084021	IC(3P) AIC1084PE(TO-252) GP	1	U5	Power translation, scaler IC power supply.
	IC	996500045092	AL001084099	IC(3P)SMD AP1084DLA(TO-252) GP	1	U5	Power translation, scaler IC power supply.
	IC	996510007624	AL001117086	IC(3P) AIC1117PY(SOT-223) GP	1	U7	Power translation, scaler IC power supply.
	IC	996510007625	AL1117EL100	IC(3P) ATC AP1117EL-13(SOT-223) GP	1	U7	Power translation, scaler IC power supply.
	TRANSISTOR	996510007626	BA001440Z87	TRANSISTOR SMD PDTC144EU (50V,30MA)GP	1	Q4	
	TRANSISTOR	996500044115	BA001440ZB8	TR CHDTC144EUP(50V,30MA)SOT-323 GP	1	Q4	
	TRANSISTOR	996510007627	BA001520Z05	TR CHDTC152EUP(50V,70MA)SOT-323 GP	1	Q4	
	TRANSISTOR	996510007628	BA039060013	TR SMD MMBT3906LT1G(40V,200MA) GP	5	Q1,Q2,Q5,Q6,Q7	
	TRANSISTOR	996500044110	BA039060Z10	TR,SMD PMBS3906(40V,200MA) GP	5	Q1,Q2,Q5,Q6,Q7	
	TRANSISTOR	996510002084	BA039060Z28	TRANSISTOR,SMD SST3906(40V,200MA) GP	5	Q1,Q2,Q5,Q6,Q7	
	TRANSISTOR	996510007629	BAM34150Z08	TR MOSFET AO3415(-20V,-4A)SOT-23 GP	1	Q3	
Mechanical Components:	Stand	996510007632	37W9ZRSU017	W9ZR STAND SUB ASSY(G80206)GP	1	Item 19 in exploded view	
	DVI&D-SUB to shielding		MBL11004018	IO NUT LI1(MBL11004,REV3A)GP	2	Item 17 in exploded view	
	PCBAs to metal shielding		MM30040IBJ9	SCREW M3.0*4.0-I(NI) GP	12	Item 2 in exploded view	
	Panel to L/R bracket		MM30040IBJ9	SCREW M3.0*4.0-I(NI) GP	6	Item 2 in exploded view	
	Hinge Cover	996510007633	EBW9ZR06025	HINGE COVER(T80206)(EBW9ZR06,REV3A)GP	1	Item 11 in exploded view	
	Base	996510007634	38W9ZRBS016	W9ZR BASE SUB ASSY(T80206)GP	1	Item 20 in exploded view	
PCBA:	Power Board	996510007671	AS54B41SA07	PI 90-264V 45W 4L(140*135)P045-1PI01 GP	1	Item 5 in exploded view	
	Main Board		10W9ZRB059	W9ZR M/B ASSY(W9ZR-V1L,NT68665)VGA/O GP	1	Item 16 in exploded view	21W9ZRB050
	Bios		AZW9ZRB0119	W9ZR-V1M SW BIOS (NT68665)CMO	1		
	Button Board	996510007673	10W9ZRB002	W9ZR BUTTON/B ASSY GP	1	Item 3 in exploded view	23W9ZRB005
Cabinets:	Front Bezel Assembly	996510009171	34W9ZRLB031	W9ZR LCD BEZEL SUB ASSY(T80206,VGA)GP	1	Item 1 in exploded view	
	Back Cover Assembly	996510009172	EAW9ZR05010	LCD COVER-VGA(T80206) W9ZR(EAW9ZR05,R3A)	1	Item 18 in exploded view	
Accessories:	VGA cable	996510007677	DDW9ZRPC009	CABLE VGA BLACK(15/15P 1.8M)W9ZRG	1		
	Power Cord	996500044139	DM333181S01	POWER CORD B 1.8M SP-506/10A (CHN) GP	1		
	Manual		HGW9ZR03012	QSG+CD W9ZR-V1(HGW9ZR03,R3A)GP	1		
	LCD film		JXW9VA01014	LCD FILM 430*285 W9VA-A4(JXW9VA01,R3A)GP	1		
Packing Material:	EPE bag		HAW9ZR01014	EPE BAG W9ZR(HAW9ZR01,R3A)GP	1		
	Carton	996510009173	HFV9ZR07017	CARTON W9ZR-V1(HFV9ZR07,R3A)CN_GP	1		
	Cushion-L	996510007680	HBW9ZR01015	END CAP-L W9ZR-C1/S1(HBW9ZR01,REV3A)GP	1		
	Cushion-R	996510007652	HBW9ZR02011	END CAP-R W9ZR-C1/S1(HBW9ZR02,REV3A)GP	1		
	Cushion-T	996510009174	HBW9ZR03018	END CAP-T W9ZR-C1/S1(HBW9ZR03,REV3A)GP	1		

>> MAIN BOARD ASSY

996510009170	W9ZR M/B ASSY(W9ZR-V1L,NT68665)VGA/O GP	L7		EMI FILT CHIP FBMA-11-201209-102 GP
	21W9ZRMBO50 W9ZR-V1L M/B Schematic(C3A)	L8		EMI FILT CHIP FBMA-11-201209-121A40 GP
	W9ZR M/B S/S ASSY(W9ZR-V1L,68665)VGA/OGP	L9		EMI FILT CHIP FBMA-11-201209-121A40 GP
	PCB M/B W9ZR(2L,98*90,REV C)NT68665 GP	L13		EMI FILT CHIP FBMA-11-201209-121A40 GP
	DAM991NA031 W9ZR PCB M/B(Gerber file & Board File)	L14		EMI FILT CHIP FBMA-11-201209-121A40 GP
CN6	CONN SMD FFC 30P 1R FS(P1.0,H2.24) GP	L15		EMI FILT CHIP FBMA-11-201209-121A40 GP
C6	CONN SMD FFC 30P 1R FS(P1.0,H2.0)GP	L17		EMI FILT CHIP FBMA-11-201209-121A40 GP
C7	CAP CHIP 0.1U,25V(+80-20%,Y5V,0603) GP	L18		TR SMD MMBT3906LT1G(40V,200MA) GP
C11	CAP CHIP 0.1U,25V(+80-20%,Y5V,0603) GP	Q1	996510007628	TR SMD MMBT3906LT1G(40V,200MA) GP
C14	CAP CHIP 0.1U,25V(+80-20%,Y5V,0603) GP	Q2	996510007628	TR SMD MMBT3906LT1G(40V,200MA) GP
C15	CAP CHIP 0.1U,25V(+80-20%,Y5V,0603) GP	Q5	996510007628	TR SMD MMBT3906LT1G(40V,200MA) GP
C19	CAP CHIP 0.1U,25V(+80-20%,Y5V,0603) GP	Q6	996510007628	TR SMD MMBT3906LT1G(40V,200MA) GP
C20	CAP CHIP 0.1U,25V(+80-20%,Y5V,0603) GP	Q7	996510007628	TR SMD MMBT3906LT1G(40V,200MA) GP
C21	CAP CHIP 0.1U,25V(+80-20%,Y5V,0603) GP	Q1	996500044110	TR,SMD PMBS3906(40V,200MA) GP
C31	CAP CHIP 0.1U,25V(+80-20%,Y5V,0603) GP	Q2	996500044110	TR,SMD PMBS3906(40V,200MA) GP
C34	CAP CHIP 0.1U,25V(+80-20%,Y5V,0603) GP	Q5	996500044110	TR,SMD PMBS3906(40V,200MA) GP
C39	CAP CHIP 0.1U,25V(+80-20%,Y5V,0603) GP	Q6	996500044110	TR,SMD PMBS3906(40V,200MA) GP
C40	CAP CHIP 0.1U,25V(+80-20%,Y5V,0603) GP	Q7	996500044110	TR,SMD PMBS3906(40V,200MA) GP
C64	CAP CHIP 0.1U,25V(+80-20%,Y5V,0603) GP	Q1	996510002084	TRANSISTOR,SMD SST3906(40V,200MA) GP
C65	CAP CHIP 0.1U,25V(+80-20%,Y5V,0603) GP	Q2	996510002084	TRANSISTOR,SMD SST3906(40V,200MA) GP
C70	CAP CHIP 0.1U,25V(+80-20%,Y5V,0603) GP	Q5	996510002084	TRANSISTOR,SMD SST3906(40V,200MA) GP
C71	CAP CHIP 0.1U,25V(+80-20%,Y5V,0603) GP	Q6	996510002084	TRANSISTOR,SMD SST3906(40V,200MA) GP
C72	CAP CHIP 0.1U,25V(+80-20%,Y5V,0603) GP	Q7	996510002084	TRANSISTOR,SMD SST3906(40V,200MA) GP
C73	CAP CHIP 0.1U,25V(+80-20%,Y5V,0603) GP	Q3	996510007629	TR MOSFET AO3415(-20V,-4A)SOT-23 GP
C74	CAP CHIP 0.1U,25V(+80-20%,Y5V,0603) GP	Q4	996510007626	TRANSISTOR SMD PDTCT144EU (50V,30MA)GP
C75	CAP CHIP 0.1U,25V(+80-20%,Y5V,0603) GP	Q4	996500044115	TR CHDTC144EUPT(50V,30MA)SOT-323 GP
C81	CAP CHIP 0.1U,25V(+80-20%,Y5V,0603) GP	Q4	996510007627	TR CHDTC152EUPT(50V,70MA)SOT-323 GP
C2	CAP CHIP 120P 50V(+5%,NPO,0603) GP	R4		RES CHIP 75 1/10W +-1%(0603) GP
C13	CAP CHIP 120P 50V(+5%,NPO,0603) GP	R10		RES CHIP 75 1/10W +-1%(0603) GP
C4	CAP CHIP 22P 50V(+5%,NPO,0603) GP	R14		RES CHIP 75 1/10W +-1%(0603) GP
C32	CAP CHIP 22P 50V(+5%,NPO,0603) GP	R41		RES CHIP 75 1/10W +-1%(0603) GP
C33	CAP CHIP 22P 50V(+5%,NPO,0603) GP	R44		RES CHIP 75 1/10W +-1%(0603) GP
C12	CAP CHIP 1U 25V(+10%,X7R,0805)GP	R47		RES CHIP 75 1/10W +-1%(0603) GP
C47	CAP CHIP 1U 25V(+10%,X7R,0805)GP	R6		RES CHIP 4.7K 1/10W +-5%(0603) GP
C16	CAP CHIP 10U 6.3V(+80%-20%,Y5V,0805) GP	R7		RES CHIP 4.7K 1/10W +-5%(0603) GP
C22	CAP CHIP 0.047UF 16V(+10%,X7R,0603) GP	R13		RES CHIP 4.7K 1/10W +-5%(0603) GP
C23	CAP CHIP 0.047UF 16V(+10%,X7R,0603) GP	R15		RES CHIP 4.7K 1/10W +-5%(0603) GP
C24	CAP CHIP 0.047UF 16V(+10%,X7R,0603) GP	R67		RES CHIP 4.7K 1/10W +-5%(0603) GP
C25	CAP CHIP 0.047UF 16V(+10%,X7R,0603) GP	R68		RES CHIP 4.7K 1/10W +-5%(0603) GP
C26	CAP CHIP 0.047UF 16V(+10%,X7R,0603) GP	R90		RES CHIP 4.7K 1/10W +-5%(0603) GP
C27	CAP CHIP 0.047UF 16V(+10%,X7R,0603) GP	R95		RES CHIP 4.7K 1/10W +-5%(0603) GP
C28	CAP CHIP 0.047UF 16V(+10%,X7R,0603) GP	R8		RES CHIP 1K 1/10W +-5%(0603) GP
C38	CAP CHIP 2200P 50V(+10%,X7R,0603)GP	R18		RES CHIP 1K 1/10W +-5%(0603) GP
C84	CAP CHIP 100P 50V(+5%,NPO,0603) GP	R74		RES CHIP 1K 1/10W +-5%(0603) GP
C85	CAP CHIP 100P 50V(+5%,NPO,0603) GP	R75		RES CHIP 1K 1/10W +-5%(0603) GP
C37	CAP CHIP 4.7U 10V(+80%-20%,Y5V,0603)GP	R79		RES CHIP 1K 1/10W +-5%(0603) GP
D28	DIODE SMD SS1030CPT(30V,0.2A,SHTKY) GP	R106		RES CHIP 1K 1/10W +-5%(0603) GP
D39	DIODE SMD SS1030CPT(30V,0.2A,SHTKY) GP	R133		RES CHIP 1K 1/10W +-5%(0603) GP
D28	DIODE SMD BAT54C(30V,200MA,SCHOTTKY)GP	R137		RES CHIP 1K 1/10W +-5%(0603) GP
D39	DIODE SMD BAT54C(30V,200MA,SCHOTTKY)GP	R9		RES CHIP 100 1/10W +-5%(0603) GP
D29	DIODE SMD ML25PT (600V,2A) GP	R11		RES CHIP 100 1/10W +-5%(0603) GP
D30	DIODE SMD ML25PT (600V,2A) GP	R39		RES CHIP 100 1/10W +-5%(0603) GP
D38	DIODE SMD SW1010CPT(100V,100MA) GP	R52		RES CHIP 100 1/10W +-5%(0603) GP
D38	DIODE SMD 1SS355(80V,100MA) GP	R53		RES CHIP 100 1/10W +-5%(0603) GP
L1	RES CHIP 0 1/10W+-5%(0603) GP	R62		RES CHIP 100 1/10W +-5%(0603) GP
L2	RES CHIP 0 1/10W+-5%(0603) GP	R131		RES CHIP 100 1/10W +-5%(0603) GP
L3	RES CHIP 0 1/10W+-5%(0603) GP	R132		RES CHIP 100 1/10W +-5%(0603) GP
L4	RES CHIP 0 1/10W+-5%(0603) GP	R16		RES CHIP 2.2K 1/10W +-5%(0603) GP
L5	RES CHIP 0 1/10W+-5%(0603) GP	R13		RES CHIP 2.2K 1/10W +-5%(0603) GP
L6	RES CHIP 0 1/10W+-5%(0603) GP	R101		RES CHIP 2.2K 1/10W +-5%(0603) GP
R59	RES CHIP 0 1/10W+-5%(0603) GP	R93		RES CHIP 82,1/10W,+-5%(0603) GP
R71	RES CHIP 0 1/10W+-5%(0603) GP	R49		RES CHIP 10 1/10W +-5%(0603)GP
R103	RES CHIP 0 1/10W+-5%(0603) GP	R38		RES CHIP 470 1/10W +-1%(0603) GP
		R42		RES CHIP 100 1/10W+-1%(0603)GP
		R45		RES CHIP 100 1/10W+-1%(0603)GP

Spare Part List

R48 RES CHIP 100 1/10W+-1%(0603)GP
 R43 RES CHIP 390 1/10W+-1%(0603) GP
 R50 RES CHIP 10K 1/10W +-5%(0603) GP
 R51 RES CHIP 10K 1/10W +-5%(0603) GP
 R57 RES CHIP 10K 1/10W +-5%(0603) GP
 R72 RES CHIP 10K 1/10W +-5%(0603) GP
 R73 RES CHIP 10K 1/10W +-5%(0603) GP
 R77 RES CHIP 10K 1/10W +-5%(0603) GP
 R81 RES CHIP 10K 1/10W +-5%(0603) GP
 R100 RES CHIP 10K 1/10W +-5%(0603) GP
 R107 RES CHIP 10K 1/10W +-5%(0603) GP
 R143 RES CHIP 10K 1/10W +-5%(0603) GP
 R61 RES CHIP 15K 1/10W +-5%(0603) GP
 R65 RES CHIP 1M 1/10W +-5% (1608) GP
 R66 RES CHIP 100K 1/10W +-5%(0603) GP
 R69 RES CHIP 20 1/10W +-5%(0603) GP
 R105 RES CHIP 2.05K 1/10W +-1%(0603) GP
 R108 RES CHIP 3.24K 1/10W +-1%(0603) GP
 R114 RES CHIP 330 1/10W +-1%(0603) GP
 R115 RES CHIP 150,1/10W,+-1%(0603) GP
 IC2 996510007622 IC EEPROM(8P)24BC16-SI(2048*8,SOIC8) GP
 IC2 996500044124 IC EEPROM(8P) BR24L16F-WE2(2K*8,SOP8)GP
 IC2 996500044125 IC EEPROM(8P)24LC16BT-I(2K*8,100KHZ) GP
 U3 996510007639 IC(128P)NT68665MFG-128(165MHZ,QFP) GP
 U5 996500045091 IC(3P) AIC1084PE(TO-252) GP
 U5 996500045092 IC(3P)SMD AP1084DLA(TO-252) GP
 U7 996510007624 IC(3P) AIC1117PY(SOT-223) GP
 U7 996510007625 IC(3P) ATC AP1117EL-13(SOT-223) GP
 R17 RES CHIP 33 1/10W +-5%(0603) GP
 R94 RES CHIP 33 1/10W +-5%(0603) GP
 CN1 CONN D-SUB 15P 3R FR(P1.15,H12.55) GP
 CN1 CONN D-SUB 15P 3R FR(P1.15,H12.55) GP
 CN5 CONN DIP HEADER 6P 2R MR(P2.5,H6.0) GP
 CN7 CONN DIP HEADER 10P 2R FR(P1.0,H3.0)GP
 C17 CAP EC 330U 16V(+/-20%,105C,8*11,LESR)GP
 C41 CAP EC 330U 16V(+/-20%,105C,8*11,LESR)GP
 C44 CAP EC 330U 16V(+/-20%,105C,8*11,LESR)GP
 C45 CAP EC 330U 16V(+/-20%,105C,8*11,LESR)GP
 C68 CAP EC 330U 16V(+/-20%,105C,8*11,LESR)GP
 C17 CAP EC 330U 16V(+/-20%,125C,8*11,2KH)GP
 C41 CAP EC 330U 16V(+/-20%,125C,8*11,2KH)GP
 C44 CAP EC 330U 16V(+/-20%,125C,8*11,2KH)GP
 C45 CAP EC 330U 16V(+/-20%,125C,8*11,2KH)GP
 C68 CAP EC 330U 16V(+/-20%,125C,8*11,2KH)GP
 C29 CAP EC 47U 10V(+/-20%,105C,5*11,2K)OSTGP
 C29 CAP EC 47U 10V(+/-20%,105C,5*11,2000H)GP
 C51 CAP EC 100U 16V(+/-20%,105C,6*11,3KHR) GP
 C52 CAP EC 100U 16V(+/-20%,105C,6*11,3KHR) GP
 Y1 XTAL DIP 12MHZ(+/-30PPM,HC-49/S TYPE) GP

>> BUTTON BOARD ASSY

996510007673 W9ZR BUTTON/B ASSY GP
 23W9ZRBB005 W9ZR BUTTON/B Schematic(A3A)
 PCB BUTTON/B W9ZR TB(2L,110*10,REVB) GP
 DAW9ZRTB028 W9ZR PCB BUTTON/B(Gerber file & Boarc
 METAL DOME SWITCH W9ZR(FCW9ZR01,R3A) GP
 METAL DOME SWITCH
 LED1 LED(SMD) Y/G(KPTB-1612YSGC) GP
 LED2 LED(SMD) BLUE(KPT-1608PBC-A) GP
 CABLE FFC MB-BB(10P/10P,452MM)W9ZR PTI
 CABLE FFC MB-BB(10P/10P,452MM)W9ZR GLE

>> POWER BOARD ASSY

996510007671 PI 90-264V 45W 4L(140*135)P045-1PI01 GP

>> LCD MODULE ASSY

996510009171 W9ZR LCD MODULE (T-C-V)ASSYGP
 W9ZR LCD BEZEL SUB ASSY(T80206,VGA)GP
 LCD BEZEL(VGA,T80206) W9ZR(EAW9ZR02,R3A)
 BUTTON-T W9ZR(80206) (EBW9ZR07,REV3A)GP
 W9ZR PCB SHIELDING ASSY(T-C-V)GP
 LCD BRACKET(T-C-V)W9ZR(FAW9ZR07,R3A)GP
 SHIELD MYLAR W9ZR(FCW9ZR02,REV3A)GP
 SHIELD MYLAR
 996510007632 W9ZR STAND SUB ASSY(G80206)GP
 HINGE ASSY W9ZR(FAW9ZR01,REV3A)GP
 HINGE ASSY
 SCREW M4.0*8-B(NI,NYLOK)GP
 STAND W9ZR(80206) (EBW9ZR03,REV3A)GP
 CLIP W9ZR(80206) (EBW9ZR05,REV3A)GP
 996510009172 LCD COVER-VGA(T80206) W9ZR(EAW9ZR05,R3A)
 LAMP CABLE SHIELD W9ZR(FBW9ZR01,R3A)GP
 LAMP CABLE SHIELD W9ZR
 POWER MYLAR W9ZR(FCW9ZR03,REV3A)GP
 POWER MYLAR
 IO NUT LI1(MBLI1004,REV3A)GP
 IO NUT LI1
 SCREW F2*2.5-I(NI) GP
 SCREW M3.0*4.0-I(NI) GP
 SCREW M4.0*8.0-B(NI,WASHER)GP

>> MISCELLANEOUS ASSY

996510007633 W9ZR MISCELLANEOUS ASSY(T)GP
 HINGE COVER(T80206)(EBW9ZR06,REV3A)GP
 SCREW M4.0*8.0-F (BNI,NYLOK,3CR)GP
 SCREW F3.0*10L-B(NI)GP
 996510007666 CABLE FFC MB-LCD(30P,163MM,GLE)W9ZR GP
 996510007667 CABLE FFC MB-LCD(30P,163MM)W9ZR PTI GP

>> PANEL KIT ASSY

996510007631 W9ZR-V1M PANEL KIT ASSY(VGA/O)CMO
 LCD 19" M190A1-L07 (1440*900,5MS)GP
 W9ZR-V1M SW BIOS (NT68665)CMO
 W9ZR SW EDID IMAGE(NT68665/NT68670)AU

>> PACKING ASSY

	W9ZR-V1 PACKING(190VW8FB/93/CN)GP
996510007634	W9ZR BASE SUB ASSY(T80206)GP
	BASE W9ZR(80206) (EBW9ZR02,REV3A)GP
	RUBBER-A FOOT W9ZR(GAW9ZR01,R3A) GP
	RUBBER-B FOOT W9ZR(GAW9ZR02,R3A) GP
	CABLE COVER W9ZR(T80206)(EBW9ZR04,R3A)GP
996510007677	CABLE VGA BLACK(15/15P 1.8M)W9ZRGF
996500044139	POWER CORD B 1.8M SP-506/10A (CHN) GP
	EPE BAG W9ZR(HAW9ZR01,R3A)GP
	EPE BAG
996510007680	END CAP-L W9ZR-C1/S1(HBW9ZR01,REV3A)GP
996510007652	END CAP-R W9ZR-C1/S1(HBW9ZR02,REV3A)GP
996510009174	END CAP-T W9ZR-C1/S1(HBW9ZR03,REV3A)GP
	TRAVEL CARD L7ZI(HCL7ZI04,REV3A) GP
	TRAVEL CARD
	3C LABEL L9V(HCL9V020,REV3A)8MM
	HI-POT LABEL L70L(HCL70021,REV3A)GP
	HI-POT LABEL
	ENERGY START STICKER W0ZR(HCW0ZR04,3A)GP
	ENERGY START STICKER
	RATING LABEL W9ZR-V1(HCW9ZR05,R3A)GP
	RATING LABEL
	CARTON LABEL W0ZR(HCW0ZR03,REV3A)GP
	CARTON LABEL
	QC PASS LABEL W0ZR(HCW0ZR11,3A)GP
	QC PASS LABEL
	WARRANTY W0ZR(HDW0ZR01,REV3A)CHINA GP
996510009173	CARTON W9ZR-V1(HFW9ZR07,R3A)CN_GP
	SPACE PLATE1270*1000 W9ZR(HFW9ZR02,3A)GP
	PAPER BOARD 1260*990 W9ZR(HFW9ZR03,3A)GP
	SPACE PLATE 850*1000 W9ZR(HFW9ZR05,3A)
	PAPER BOARD 830*980 W9ZR(HFW9ZR06,3A)
	QSG+CD W9ZR-V1(HGW9ZR03,R3A)GP
	TYPE L7ZI-A1(JXL7ZI04,REV3A)(72MM) GP
	HANDLE UPPER W9C-B1(JXW9C001,REV3A)GP
	HANDLE UPPER
	HANDLE DOWN W9C-B1(JXW9C002,REV3A)GP
	HANDLE DOWN
	LCD FILM 430*285 W9VA-A4(JXW9VA01,R3A)GP
	LCD FILM

Different Part List

19 inch monitor different parts list

190VW8FB/93/CN(W9ZR-V1M)

190VW8FB/93/CN(W9ZR-V1L)

Item	Part Number	Part Description	2nd source		
1	24W9ZRLA051	W9ZR LCD MODULE (T-C-V)ASSYGP		V	
	24W9ZRLA042	W9ZR LCD MODULE (T-L-V)ASSYGP			V
2	2AW9ZRPTM22	W9ZR-V1M PANEL KIT ASSY(VGA/O)CMO		V	
	2AW9ZRPTL25	W9ZR-V1L PANEL KIT ASSY(VGA/O)LPL			V
3	36W9ZRPS053	W9ZR PCB SHIELDING ASSY(T-C-V)GP		V	
	36W9ZRPS045	W9ZR PCB SHIELDING ASSY(T-L-V)GP			V

General Trouble Shooting Guide

www.DataSheet4U.com

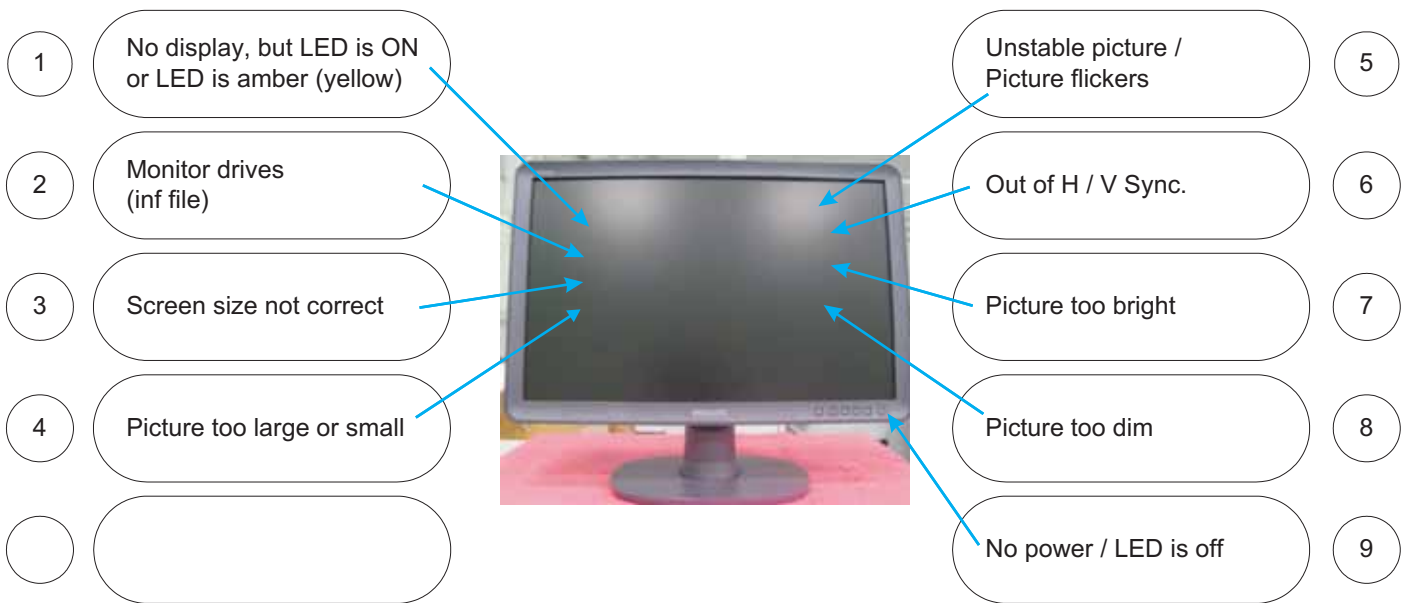

General Trouble Shooting Guide

1

No display, but LED is ON
or LED is amber (yellow)

Check point:

1. Click your mouse or type some word with your keyboard to wake up computer from saving status.
2. Check that your video cable is plugged in and does not have bent pins.

LED Amber or Green?

Continued

Note:

Do not set screen saver – at “14” minutes.

It will cause “ no display” problem as above mentioned.

Action: Change timer setting of screen saver or disable screen saver.

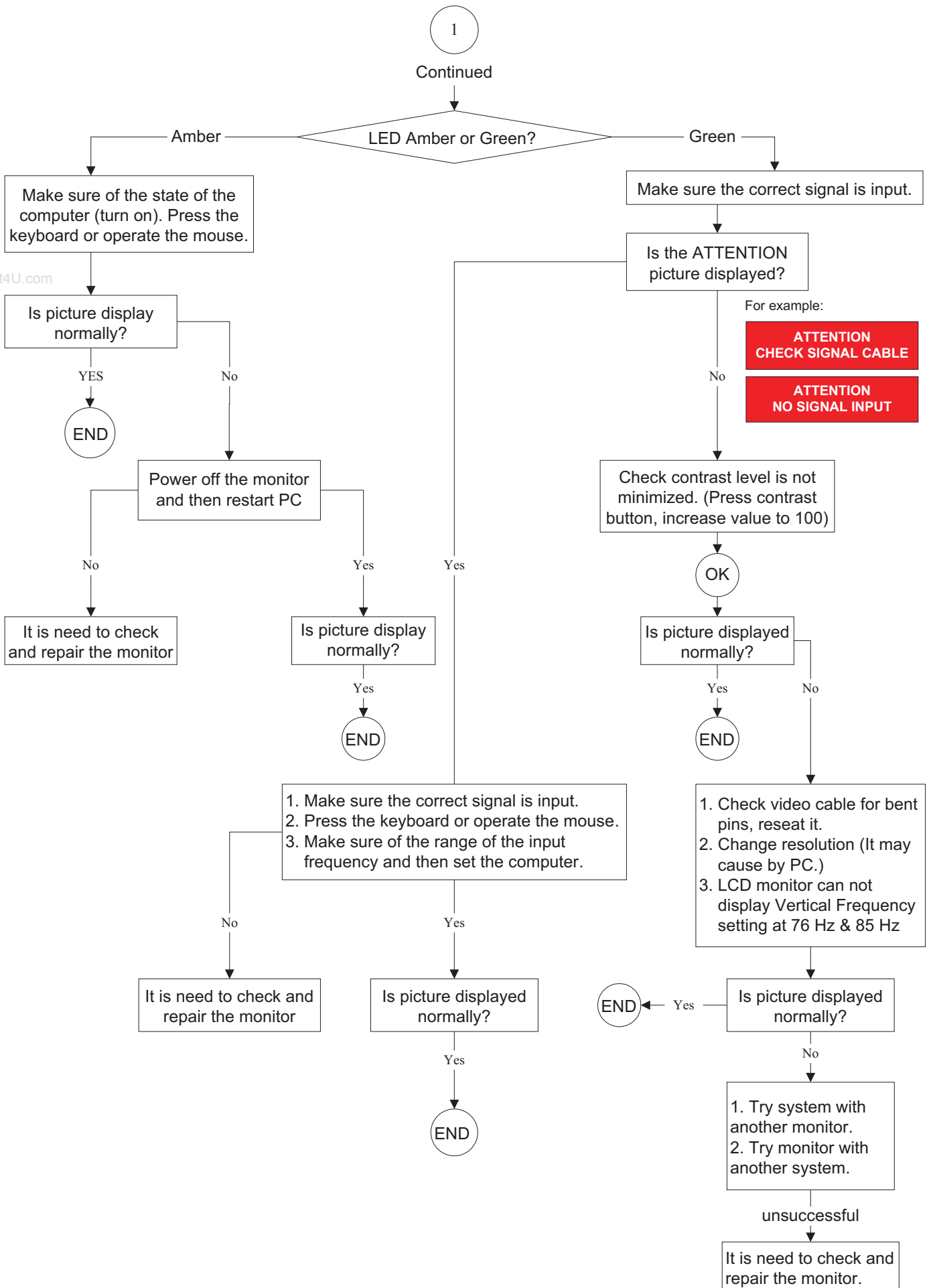

www.DataSheet4U.com

General Trouble Shooting Guide

2

Monitor drivers (inf file)

FOR WINDOWS 95/98/2000/ME OR LATER

Philips's monitors build in VESA DDC2B feature to support Plug & Play requirement for Windows 95/98/2000/Me. You can install the information file(.inf) in order to select your Philips monitor from "Monitor" dialog box in Windows 95/98/2000/Me to activate Plug & Play application. The installation procedure based on Windows 95 OEM Release 2, 98, Me and 2000 is specified as follows, (in case of connecting the monitor to the PC compliant with VESA standard with the designated signal cable, the PC reads display pixels, frequency and color feature of this monitor to optimize the picture for the monitor automatically.)

DDC: Abbreviation for Display Data Channel

**** Windows NT 4.0 does not require driver (inf file) for monitor.****

For Windows 95

For Windows 95 drivers, your monitor is listed under manufacture name "Philips Business Electronics Co."

1. Start Windows 95
2. Click the 'Start' button, point to 'setting', and then click 'control panel'.
3. Double click the 'display' icon.
4. Choose the 'setting' tab then click 'advanced...'
5. Choose 'monitor' button, point to 'change...' then click 'have disk...'
6. Click 'browse...' button then choose the appropriate drive F:(CD-ROM Drive) then click 'ok' button.
7. Click the 'ok' button then choose your monitor model and click the 'ok'.
8. Click 'close' button.

For Windows 98

For Windows 98 drivers, our monitors are listed under 2 manufactures name "Philips", and "Philips Consumer Electronics Co." Please select "Philips" when you would like to set up your monitor in Windows setting, if you can not find the right model name just as the label indication on the back of set. For those set that have been issued since the release of Window 98, drivers can be found in CD-ROM under the directory path of "\pc\driver\" or it may be downloaded at <http://www.philips.com>. Once you have installed the new driver, Windows will add a new manufacture name "Philips Business Electronics" in your system.

1. Start Windows 98
2. Click the 'Start' button, point to 'setting', and then click 'control panel'.
3. Double click the 'display' icon.
4. Choose the 'setting' tab then click 'advanced...'
5. Choose 'monitor' button, point to 'change...' then click 'next'.
6. Choose 'display a list of all the drivers in a specify location, so you can select the driver you want', then click 'next' and then click 'have disk...'
7. Click 'browse...' button then choose the appropriate drive F: (RD-ROM Drive) then click 'ok' button.
8. Click the 'ok' button then choose your monitor model and click the 'next' button.
9. Click 'finish' button then click 'close' button.

For Window Me

1. Start Window Me
2. Click the 'start' button, point to 'setting', and then click 'control panel'.
3. Double click the 'display' icon.
4. Choose the 'setting' tab then click 'advanced...'
5. Choose 'monitor' button, then click 'change...' button.
6. Choose 'specify the location of the driver (advanced)' and click the 'next' button.
7. Choose 'display a list of all the drivers in a specific location, so you can select the driver you want', then click 'next' and then click 'have disk...'
8. Click 'browse...' button then choose the appropriate drive F: (CD-ROM Drive) then click 'ok' button.
9. Click the 'ok' button then choose your monitor model and click the 'next' button.
10. Click 'finish' button then click 'close' button.

For Windows 2000

1. Start Windows 2000
2. Click the 'start' button, point to 'setting', and then click 'control panel'.
3. Double click the 'display' icon.
4. Choose the 'setting' tab then click 'advanced...'
5. Choose 'monitor';
- If the 'properties' button is inactive, it means your monitor is properly configured. Please stop installation.
- If the 'properties' button is active, click 'properties' button.
6. Click 'driver' and then click on 'update driver...' then click on the 'next' button.
7. Choose 'display a list of the known drivers for this device so that I can choose a specific driver' then click 'next' and then click 'have disk...'
8. Click 'browse...' button then choose the appropriate drive F: (CD-ROM Drive).
9. Click the 'open' button then click the 'ok' button.
10. Choose your monitor model and click the 'next' button.
11. Click 'finish' button and then click the 'close' button. If you can see the 'digital signature not found' window then click the 'yes' button.

www.DataSheet4U.com

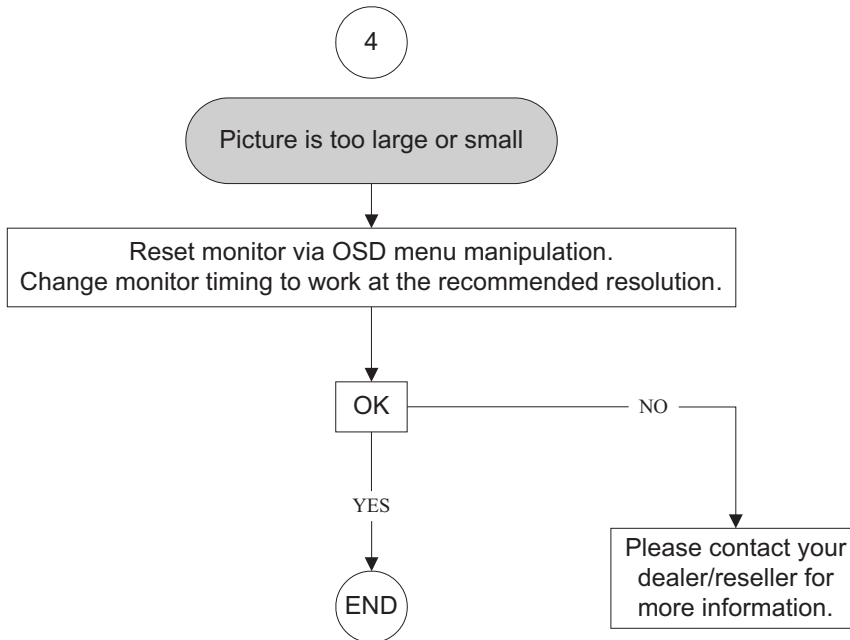
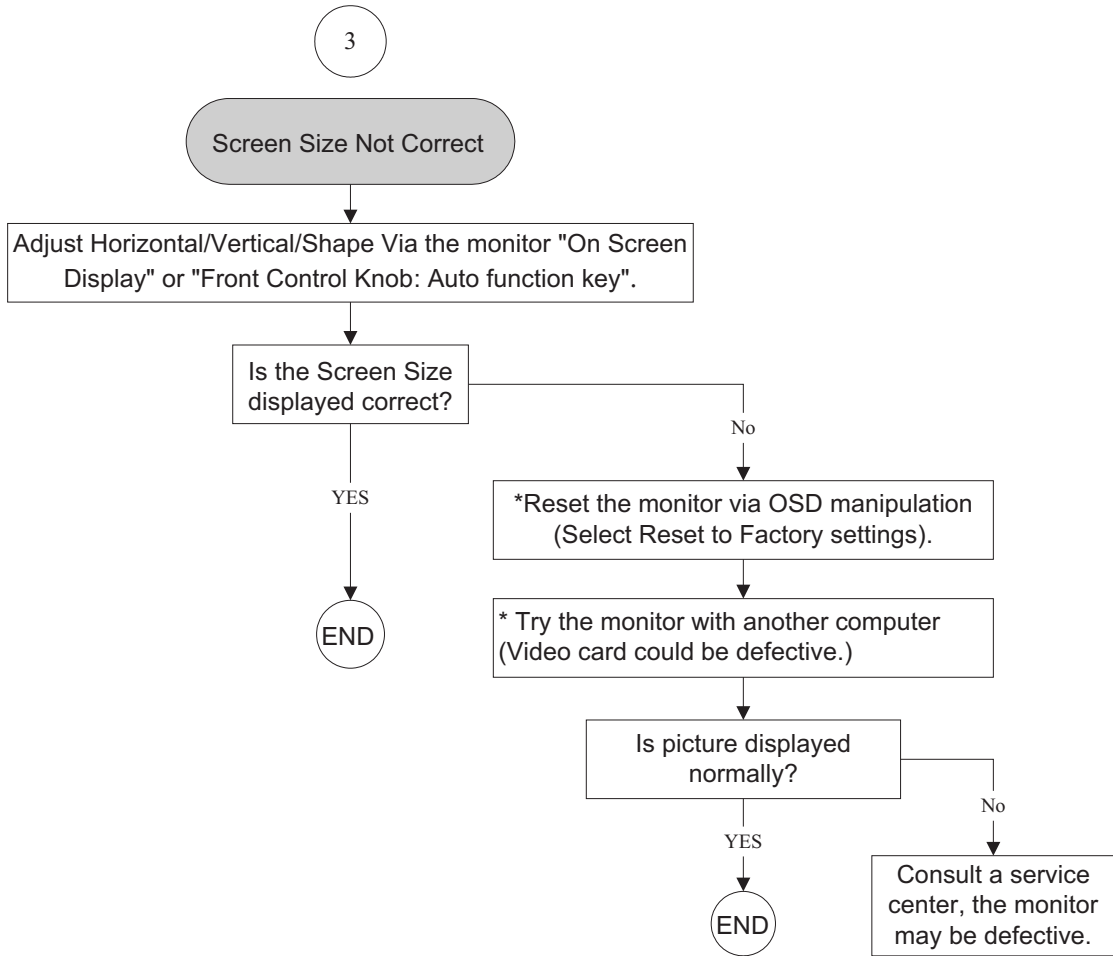

General Trouble Shooting Guide

6

Unstable picture/picture flickers

Vertical/Horizontal flicker appears,
Push the AUTO button. Eliminate the Vertical/Horizontal bars
using the Phase Adjustment in the first window.

OK

YES

END

NO

Please contact your
dealer/reseller for
more information.

7

Out of H/V Sync.

1. Turn off monitor
2. Disconnect signal cable
3. Turn on monitor

In the self test?
(warning signal)

YES

It is need to check and repair the monitor

NO

Check video cable for bent pins, reseal to system video and power system.

Try to go into the DOS prompt.

"H/V sync. Out of presetting timing range" or "Sync. Problem"?

YES

1. Try system with another monitor
2. Try monitor with another system

Monitor related?

YES

It is need to check and repair the monitor

NO

Video system problem

END

NO

Make sure that the video system doesn't select a driver that is outside the monitor H/V scan range out of presetting timing range while going into windows.

Run windows by using basic VGA mode (example 640*480)

"H/V sync. Out of presetting timing range" or "Sync. Problem"?

YES

1. Try system with another monitor
2. Try monitor with another system

Monitor related?

YES

It is need to check and repair the monitor

NO

END

General Trouble Shooting Guide

8

Picture is too bright

Adjust brightness and/or contrast via
the monitor "On Screen Display"
or "Front Control Knob"

Is picture displayed
normally?

YES

END

NO

* Reset the monitor via OSD manipulation.
(Select Reset to factory settings;)
* (or change the color temperature settings
to be 9300 color coordination from OSD menu.)

* Try the monitor with another computer
(video card could be defective.)

Is picture displayed
normally?

YES

END

NO

It is need to check and
repair the monitor

9

Picture is too dim

Adjust brightness and/or contrast via the monitor "On Screen Display" or "Front Control Knob".

Is picture displayed normally?

YES

END

Is an external Anti-Glare screen (like protective cover, touch screen...etc) being used?

Remove any external Anti-Glare screen

Is picture displayed normally?

YES

END

NO

NO

* Reset the monitor via OSD manipulation. (select Reset to factory settings)
* (or change the color temperature settings to be 9300 color coordination from OSD menu)

* Try the monitor with another computer (video card could be defective)

Is picture displayed normally?

YES

END

NO

It is need to check and repair the monitor

Note:

1. Sun light passing through a window is much brighter than monitor luminance (luminance is the measurable quantity which most closely corresponds to brightness), therefore the two worst places for a monitor is directly facing the window or directly behind the window. Position the monitor away from these two areas.

General Trouble Shooting Guide

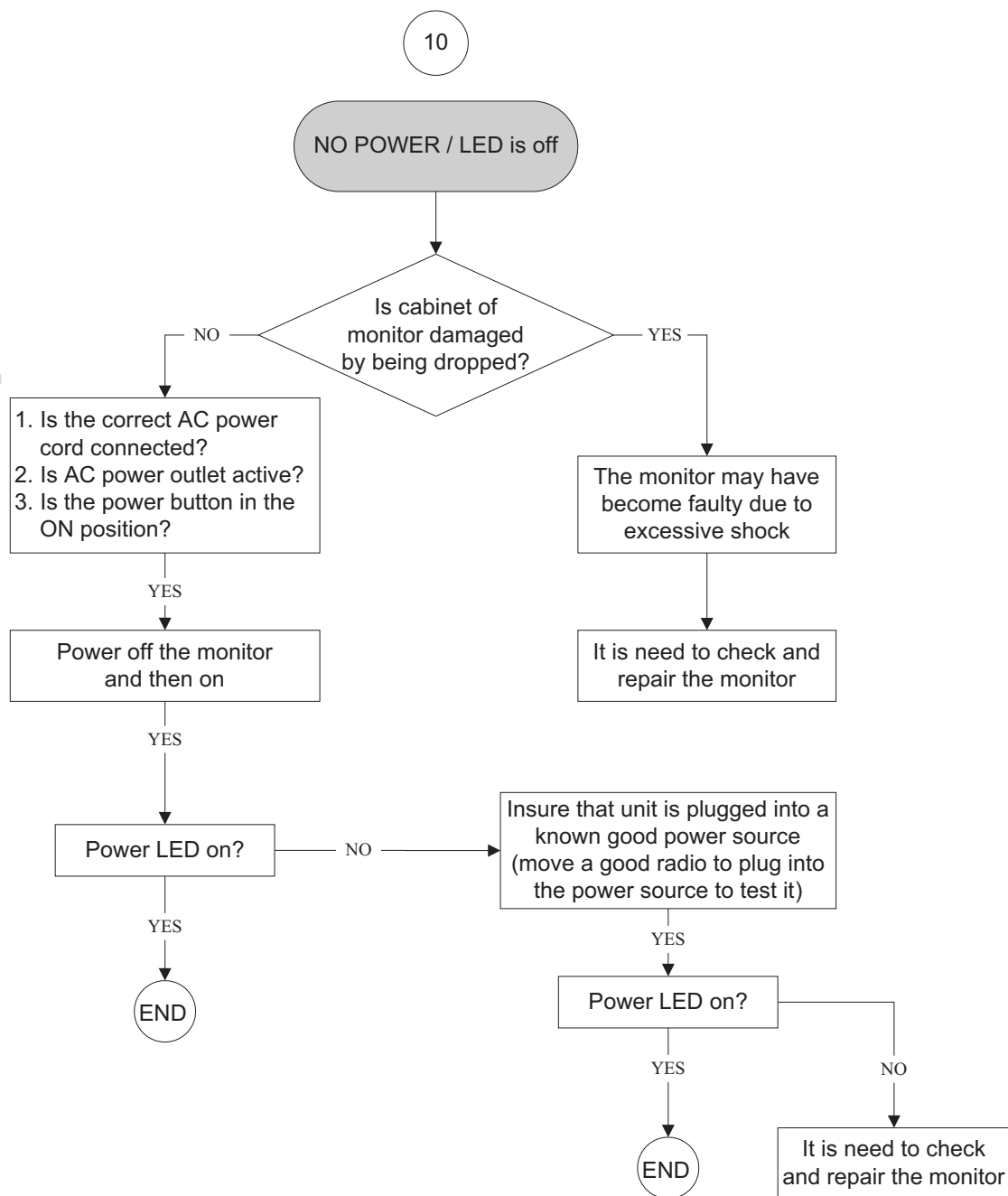

www.DataSheet4U.com

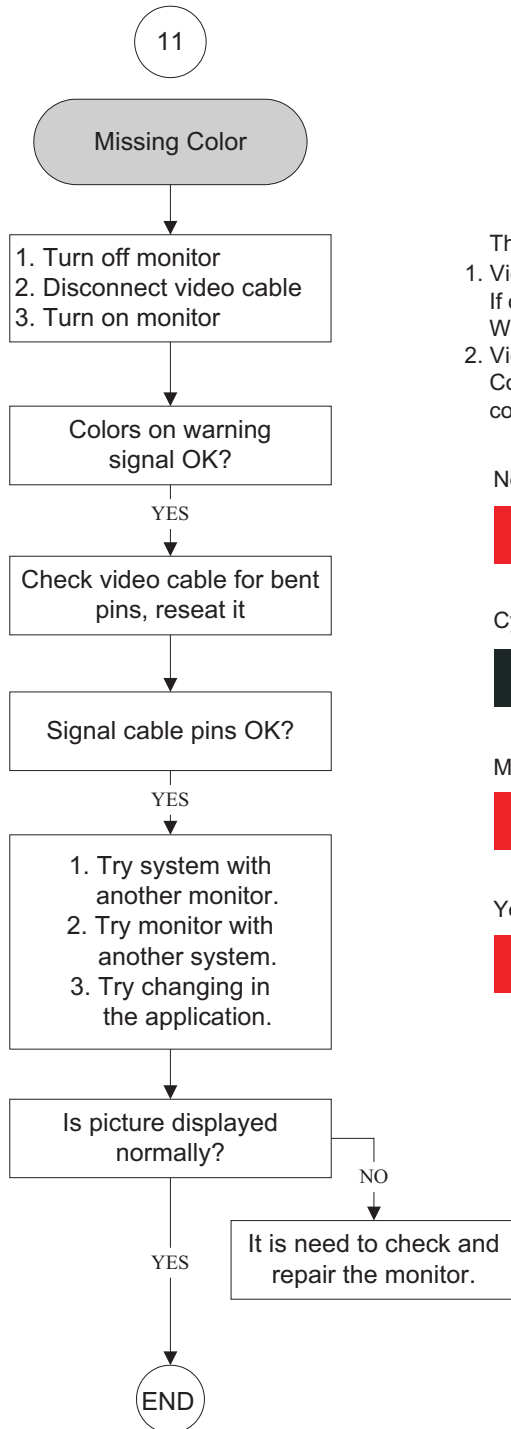

There are 2 easy ways to determine the Missing color problem.

1. View an image that is supposed to be "White".
If one of the colors (RGB) is not functioning,
White can not be produced.
2. View an image that supposed to contain Red, Green and Blue.
Color problems will be apparent when one or more of these
colors can not be displayed.

Normal White:



Cyan Color means that the red sub pixel is missing.



Magenta or Purple Color means that the green sub pixel is missing.



Yellow Color means that the blue sub pixel is missing.



General Trouble Shooting Guide

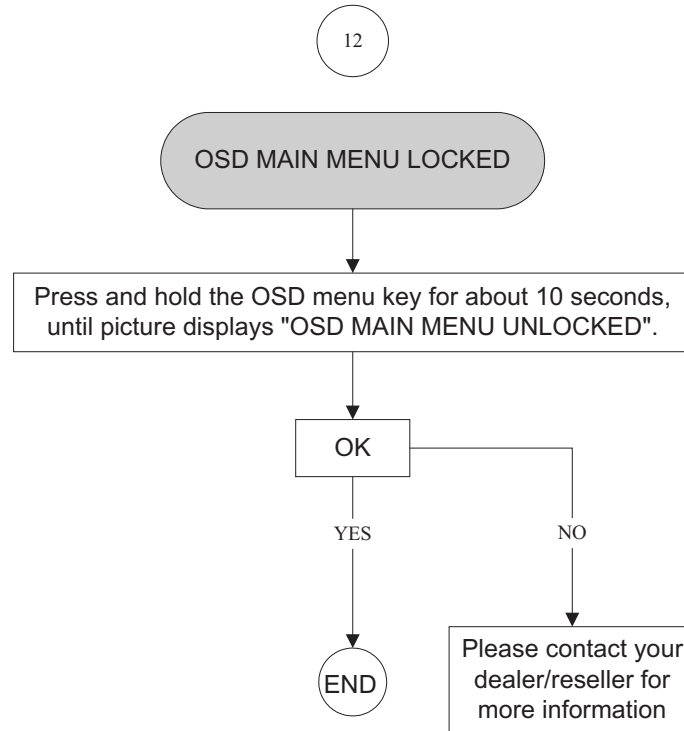

12

OSD MAIN MENU LOCKED

Press and hold the OSD menu key for about 10 seconds, until picture displays "OSD MAIN MENU UNLOCKED".

OK

YES

END

NO

Please contact your dealer/reseller for more information

General Trouble Shooting Guide

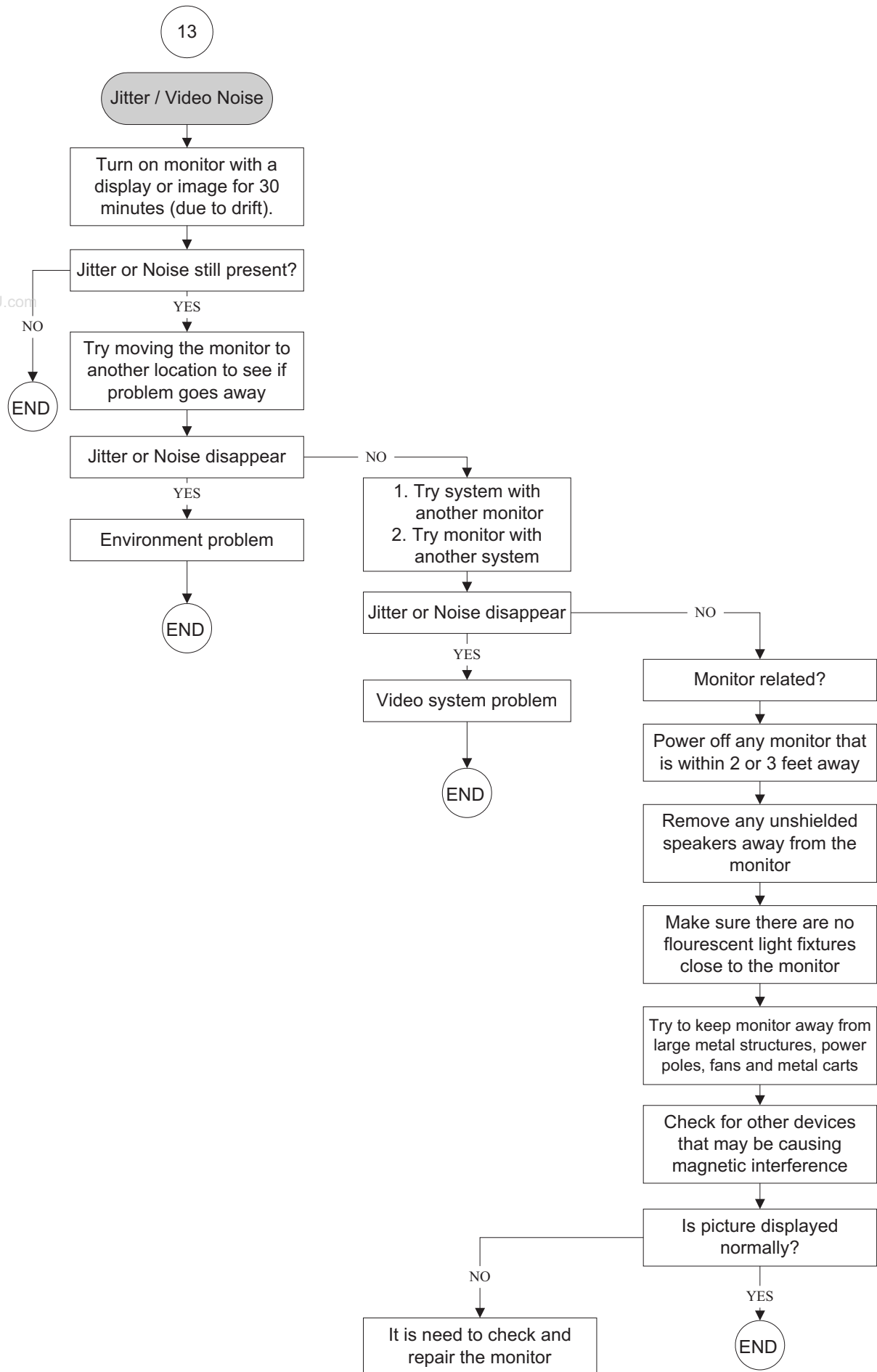

14

Power management function is not active

Verify the PC is compliant with VESA. In case all of the video signals of PC are not off, power management function is not active normally. (Repeat to power on and off power management.) There are accelerator boards not complied with VESA.

OK

YES

END

NO

Consult a service center, the monitor may be defective

General Product Specification

Specification for TVI W9ZR-V1L/V1M
Philips Hudson 8 – 190VW8

19"W TFT LCD Monitor,
30 - 83 kHz, 56 - 76 Hz, Dual input

www.DataSheet4U.com

Table of Contents

- 1. PRODUCT SPECIFICATION**
 - 1.1 Relationship
 - 1.2 Product Data
- 2. MECHANICAL SPECIFICATION**
 - 2.1.1 Monitor Housing
 - 2.1.2 VESA mounting holes
 - 2.1.3 Kensington Slot
 - 2.2 Tilt / Swivel base of the monitor
 - 2.3 Dimensions of monitor
 - 2.4 Dimensions of pallet and quantity
- 3. LCD SPECIFICATION**
 - 3.1 LCD specification
- 4. COSMETICS APPEARANCE**
 - 4.1 GAP definition
 - 4.2 Panel Offset
 - 4.3 Horizontal tilt
- 5. CONNECTORS**
 - 5.1 Video Connection
 - 5.2 PIN Assignment
 - 5.2.1 15 pin mini D-Sub connector
- 6. OSD**
 - 6.1 Control of OSD
 - 6.2 Adjustment Parameters
- 7. ELECTRICAL SPECIFICATION**
 - 7.1 Power Specification
 - 7.1.1 AC-DC converter
 - 7.1.2 Power Management
 - 7.2 Standard Test conditions
 - 7.3 Test equipment
 - 7.4 Video Generator test sequence
 - 7.5 Analog input
 - 7.6 Optical response time
 - 7.7 Protection circuit
 - 7.8 DDC
 - 7.8.1 DDC Details
 - 7.9 Timings
 - 7.10 Audio Specification

8. DISPLAY PERFORMANCE

- 8.1 Picture performance
- 8.2 Geometric defects
- 8.3 Picture stability during warm up
- 8.4 Scratches
- 8.5 Viewing angle
- 8.6 Jitter
- 8.7 Missing Pixels / missing subpixel
- 8.8 Newton Ring
- 8.9 Luminance Output
- 8.9.1 Luminance Output
- 8.9.2 Brightness
- 8.9.3 Brightness Uniformity
- 8.10 White Uniformity
- 8.11 Contrast ratio
- 8.12 White color adjustment
- 8.13 Distance between TFT LCD monitor and CRT/TFT monitor

9. ENVIRONMENT

- 9.1 Environmental conditions

10. REGULATORY STANDARDS

- 10.1 Safety approvals
- 10.2 Power management
- 10.3 Certificates, Reports for the production start

11. RELIABILITY

- 11.1 Reliability of the monitor

12. CUSTOMIZATION

- 12.1 Identity Customization
- 12.2 EAN /SAP Identification
- 12.3 Plastic
- 12.4 Definition of serial number
- 12.5 Definition of the barcode label
- 12.6 Accessories

13. ECR-HANDLING

1. PRODUCT SPECIFICATION

1.1 Relationship

Supplier:	TVI	Model:	W9ZR-V1L/V1M
Customer:	Philips	Model:	Hudson 8 -190VW8
<ul style="list-style-type: none"> • Monitor No: HWS8200Q • EAN / UPC No: 87 12895 35560 9 • CTN: 190VW8FB/93 • Site Code: CJ (TVE); CU (QCG) 			

1.2 Product Data

19" W TFT LCD monitor

Horizontal frequency	30 - 83 KHz
Vertical frequency	55 - 76 Hz
Screen diagonal	19"W Inch
Viewing Angle(CR>10)(H/V)	160/160 °
Max. opening horizontal picture size	427.2 mm
Max. opening vertical picture size	277.4 mm
Max. active horizontal picture size	410.4 mm
Max. active vertical picture size	256.5 mm

2. MECHANICAL SPECIFICATION

2.1.1 Monitor Housing

The front bezel and the back cabinet are based on TVI OEM tooling and Philips design chin.

2.1.2 VESA mounting holes

According to VESA FPMPMI standard.
Holes 100 mm x 100 mm (M 4.0, 0.7 pitch threaded) in the rear center for ARM.

2.1.3 Kensington Slot

The monitor is equipped with a 7 mm x 3 mm slot.

2.2 Tilt of the monitor

Forward	-5 ° +2/- 0
Backward	+25 ° +0/- 3 °

2.3 Dimensions of monitor

The monitor has the following dimensions:

Unit dimension	: 513.8mm (W) * 416.2mm (H) * 213.6mm (D)
Packed unit dimension	: 565mm (W) * 174.0mm (H) * 472.0mm (D) for WW
	: 567mm (W) * 189mm (H) * 480mm (D) for China
Net weight	: 5 Kg (Including I/F cable 240 g)
Gross weight	: 5.3 Kg for China

3. LCD SPECIFICATION

3.1 LCD specification

	LPL	CMO
Type NR.	LPL, LM190WX1-TLA1	CMO, M190A1-L07
Outside dimensions	427.2(H) x 277.4(V) x 15.3(D) mm(Typ.)	427.2(w)*277.4(h)*17.0(d) (Typ) mm
Pitch (mm)	0.095*RGB(H)mm x 0.285(V)mm	0.285 mm x 0.285 mm
Color pixel arrangement	RGB vertical stripes	RGB vertical stripes
Display surface	Hard coating (3H), Anti-glare treatment of the front polarizer	low reflection, antiglare with hard coating
Color depth	16.7M colors	16.7M colors (6 bits+FRC)
Backlight	CCFL edge light system	CCFL edge light system
Active area(WxH)	410.4 (H) x 256.5 (V)	410.4 x 256.5mm (19.05" diagonal)
View angle	R/L 160(Typ.), U/D 160(Typ.)	75/75 (min), 85/85 (typ) for Horizontal & 70/70 (min), 80/80 (typ) for Vertical
Contrast ratio	1000:1(Typ.) 700:1(Min.)	850:1(Typ.) 500:1(Min.)
White luminance	Original color 250 nits (Min), 300 nits (Typ.)	Original color 230 nits (Min), 300 nits (Typ.)
Gate IC	OKI MT3805VA	Himax (HX8636A)
Source IC	MAGNA D10D3SS639	Himax (HX8018A)
Response time	5ms (typ)	5ms (typ)

4 COSMETICS APPEARANCE

4.1 GAP definition

The gap between LCD and front bezel must be $\leq 1.0\text{mm}$

4.2 Panel Offset

Panel Offset: Panel disposition tolerance inside the front bezel must be $\leq 1.0\text{mm}$

4.3 Horizontal tilt

Horizontal tilt between front bezel & LCD shall be $\leq 1.0\text{mm}$

5. CONNECTORS

5.1 Video Connection

The monitor is equipped with a 15 pin mini D-SUB connector.

5.2 PIN Assignment

5.2.1 15 pin mini D-Sub connector

The PIN assignment of the 15 pin mini D-SUB connector / cable is as follows:

PIN No.	SIGNAL
1	Red
2	Green/ SOG
3	Blue

4	Sense (GND)
5	Cable Detect (GND)
6	Red GND
7	Green GND
8	Blue GND
9	DDC +3.3V or +5V
10	Logic GND
11	Sense (GND)
12	Bi-directional data
13	H/H+V sync
14	V-sync
15	Data clock

6. OSD

6.1 Control of OSD

The positions and functions of the buttons are defined as below.

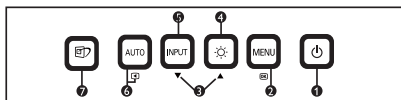

6.2 Adjustment Parameters

Hot-key definition

	Key	Key Press Time	OSD Timeout	EDFU implement	Service menu
Monitor Controls Lock	OK(Menu)	6 sec (lock/unlock)	3 sec	V	V
Factory Mode	AUTO+OK+Power On	Keep pressing when power on			V
Demo mode for smart image	Smart Image Key	3 sec (Enter/Quit)		V	V
DDC/CI On/OFF for VISTA	UP+DOWN	6 sec (lock/unlock)	3 sec	V	V

1 st LEVEL	2 nd LEVEL
MONITOR SETUP	
Exit	
Picture	Brightness
	Contrast
	Factory
Color	Color Temperature

	sRGB
	User Define
Language	Русский
	Chinese(Simple)
OSD Settings	Horizontal
	Vertical
	Transparency
	OSD Time Out
Setup	Phase
	H.Position
	V.Position
	SmartContrast
	Reset
Input	Auto
	VGA
Serial No.:	CJ2A074012345
(Serial No.)	
Timing Mode	
Up/Down to Move, ok to Confirm	

7. ELECTRICAL SPECIFICATION

7.1 Power Specification

7.1.1 AC-DC converter

Input voltage	90- 264V
Frequency range	50/ 60 ± 2 Hz
Inrush current	Shall be less than the ratings of critical components (including fuse, rectifiers and surge limiting device) for all conditions of line in voltage.

Maximum power consumption: <36W (Max)

7.1.2 Power Management

Mode	HSYNC	VSNC	Video	Pwr-cons.	Indication	Rec. time
Power-On	On	On	active	< 36 W	Green LED	--
Off	Off	Off	blanked	< 1 W	Amber LED	< 3 s
DC Power Off			N/A	< 1 W	LED Off	

7.2 Standard Test conditions

Unless otherwise specified, this specification is defined, under the following conditions.

- (1) Input signal : As defined in 3.3, 1440*900, non-interlaced mode (1440*900@60Hz 146.25MHz), signal, sources must have 75 ohm output impedance.
- (2) Luminance setting : controls to be set to 300 nits with full screen 100 % duty cycle white signal
- (3) Warm up: more than 30 minutes after power on with signal supplied.
- (4) Ambient light: 400 -- 600 lux.
- (5) Ambient temperature: 20 ± 5 °C

7.3 Test equipment

- Personal computer with Windows 98/2000/XP
- Luminance meter Minolta CA110
- Videogenerator: Chroma 2000, 2135, 2250 or equivalent
- Colour analyzer: Minolta or Chroma
- 10 times magnifier
- Ruler / Template
- Thickness gauge
- Watt / Power Meter

7.4 Video Generator test sequence

Will be defined by TVI or its subcontracted quality providers.

7.5 Analog input

Polarity: positive, negative
 Impedance: 75 Ω ± 1%
 Sync: HV separate sync, composite sync,

7.6 Optical response time

Video Bandwidth: 140 MHz (dot rate)
 Typical rise time: 5 ms

7.7 Protection circuit

The monitor will not be damaged by:

- missing vertical or horizontal sync pulse
- improper vertical or horizontal sync pulse (picture must be black at improper signals, unsynchronized pictures are not allowed)

7.8 DDC

The monitor can support DDC 2 B and DDC-CI according to the latest VESA standard.

7.8.1 DDC Details

1	User visible strings on .inf file	Philips 190VW8 (19inch WIDE LCD MONITOR 190VW8)
2	Manufacturer ID (EDID data)	PHL
3	Product ID, "xxxx" 4 codes	MSB(byte 12): 08 LSB (byte 11): 60
4	maximum resolution	1440x900
5	Horizontal Frequency Range	30~83 KHz
6	Vertical Frequency Range	55~76Hz
7	Monitor Name (13 characteries max.)	Philips 190VW

7.9 Timings

Factory preset modes : 15
 Preset modes : 48
 User modes : 10

Note: 1. Screen displays perfect picture at 15 factory-preset modes.
 2. Screen displays visible picture with OSD warning when input modes are the 48 preset modes.

Factory preset modes (15 modes)

Item	H.Freq. (KHz)	Mode	Resolution	V.Freq. (Hz)	BW(MHz)
1	31.469	IBM VGA 10H	640x350	70.086	
2	31.469	IBM VGA 3H	720x400	70.087	
3	31.469	IBM VGA 12H	640x480	59.94	
4	35	MACINTOSH	640x480	67	
5	37.861	VESA	640x480	72.809	
6	37.5	VESA	640x480	75	
7	43.269	VESA	640x480	85.008	
8	35.156	VESA	800x600	56.25	
9	37.879	VESA	800x600	60.317	
10	48.077	VESA	800x600	72.188	
11	46.875	VESA	800x600	75	
12	53.674	VESA	800x600	85.061	
13	49.7	MACINTOSH	832x624	75	
14	56.4	-	960x720	75	
15	44.75	-	960x720	60	
16	48.363	VESA	1024x768	60.004	
17	56.476	VESA	1024x768	70.069	
18	60.023	VESA	1024x768	75.029	
19	61.08	IBM XGA-2	1024x768	75.781	
20	68.677	VESA	1024x768	84.997	
21		CVT 2.3MA	1280 x768	60	
22	60.289	CVT 2.3MA	1280 x768	75	
23	54.1		1152x864	60	
24	63.851	VESA	1152x864	70.012	
25	67.5	VESA	1152x864	75	
26	68.7	MACINTOSH	1152x870	75	
27	61.845	SUN WS	1152x900	66.004	
28	71.81	SUN WS	1152x900	76.15	
29	60	VESA	1280x960	60	
30	75	VESA	1280x960	75	
31	63.981	VESA	1280x1024	60.02	
32	71.691	SUN WS	1280x1024	67.189	
33	76	DOS/V	1280x1024	72	
34	79.976	VESA	1280x1024	75.025	
35	81.13	SUN WS	1280x1024	76.11	
36	91.1	VESA	1280x1024	85	

37	44.772	-	1280x720	60	
38	52.5	-	1280x720	70	
39	64	CVT-reduced blanking	1400x1050	60	101
40	80	CVT	1400x1050	75	121.75
41	91.1	CVT	1400x1050	85	156
42	55.469	VESA-reduced blanking mode	1440x900	59.901	88.75
43	55.935	VESA	1440x900	59.887	106.5
44	70.635	VESA	1440x900	74.984	136.75
45	75	VESA	1600x1200	60	161
46	66.587	CVT 2.3MA-R	1920x1080	60.0	138.5
47	65.29	CVT1.76MW	1680x1050	60	146
48		CVT1.76MW-R	1680x1050	60	119

7.10 Audio Specification

N/A

8. DISPLAY PERFORMANCE

8.1 Picture performance

Optical performance test must be done in a dark room.

Note: Test under standard test conditions unless otherwise specified

Active Image Size (all modes)

8.2 Geometric defects

No vertical or/and horizontal line defect.

No cross line defect.

8.3 Picture stability during warm up

During 10 - 30 minutes warm up time from cold condition of the monitor at ambient temperature ($25^{\circ}\text{C} \pm 5^{\circ}\text{C}$) the decrease of brightness must be less than 6 Fl.

8.4 Scratches

No scratches and foreign particles visible.

8.5 Viewing angle

	Typical(10:1)
Horizontal (Right + Left)	160°
Vertical (Up + Down)	160°

8.6 Jitter

No jitter visible in each condition. In case of problem a limit sample has to be defined.

8.7 Missing Pixels / missing subpixel

BRIGHT DOT DEFECTS	ACCEPTABLE LEVEL
<i>MODEL</i>	190VW8
1 lit sub-pixel	3
2 adjacent lit sub-pixels	1
3 adjacent lit sub-pixels (one white pixel)	0
Distance between two bright dot defects*	25mm
Bright dot defects within 20 mm circle	0
Total bright dot defects of all type	3

BLACK DOT DEFECTS	ACCEPTABLE LEVEL
<i>MODEL</i>	190VW8
1 dark sub-pixel	5
2 adjacent dark sub-pixels	2
3 adjacent dark sub-pixels (one white pixel)	0
Distance between two black dot defects*	15mm
Black dot defects within 20 mm circle*	1
Total black dot defects of all type	5

TOTAL DOT DEFECTS	ACCEPTABLE LEVEL
<i>MODEL</i>	190VW8
Total bright or black dot defects of all type	5

* 1 or 2 adjacent sub-pixel defects = 1 dot defect

8.8 Newton Ring

No Newton Rings visible.

8.9 Luminance Output

8.9.1 Luminance Output

Test resolution: 1440X900 at 75 Hz
 Test condition: video input (RGB) = maximum white

8.9.2 Brightness

To follow Panel specification. sRGB = 80 ± 10 nits.

8.9.3 Brightness uniformity

Set contrast at 100% and turn the brightness to get average above 300 nits at centre of the screen. Apply the Fig 1, it should comply with the following formula:

$$\frac{B_{\min}}{B_{\max}} \times 100\% > 75\%$$

Where B_max = Maximum brightness
 B_min = Minimum brightness

8.10 White Uniformity

Definition of White Variation (δW):

Measure the luminance of gray level 255 at 9 points

$$\delta W = \text{Maximum } [L(1), L(2) \dots L(9)] / \text{Minimum } [L(1), L(2) \dots L(9)]$$

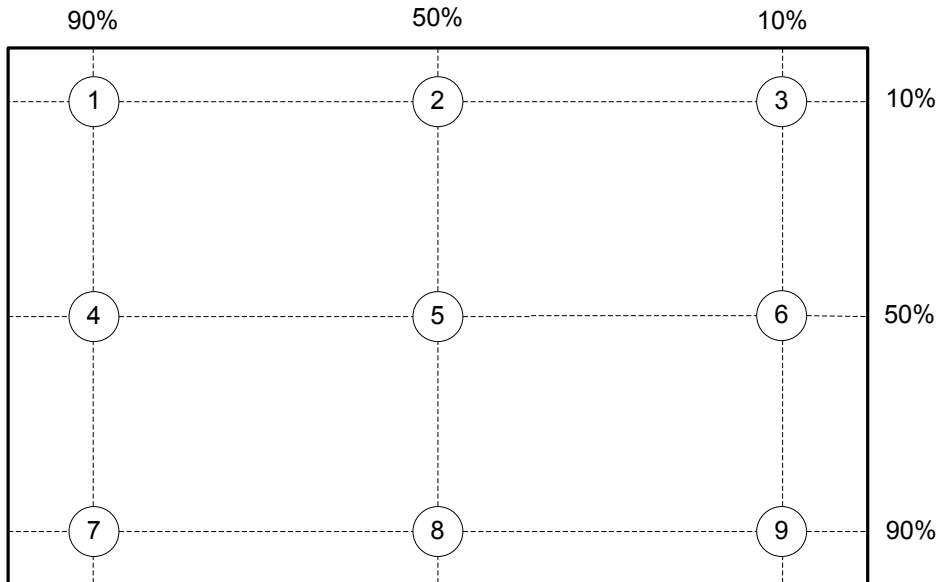

Spec : ≤ 1.33 (In all ranges)

8.11 Contrast ratio

The contrast ration can be calculated by following expression.

$$\text{Contrast Ratio (CR)} = L_{255} / L_0$$

L255 : Luminance of gray level 255

L0 : Luminance of gray level 0

Typical value: 1000:1

8.12 White color adjustment

There are six factory preset white color 11500K, 9300K, 8200K, 7500K, 6500K, sRGB, 5000K

Apply full gray64 pattern, with brightness in 100 % position and the contrast control at 50 % position.

The 1931 CIE Chromaticity (color triangle) diagram (x , y) coordinate for the screen center should be:

Product specification

CIE coordinates	(x,y)
11500K	x = 0.270 ± 0.02
	y = 0.281 ± 0.02
9300K	x = 0.283 ± 0.02
	y = 0.297 ± 0.02
8200K	x = 0.291 ± 0.02
	y = 0.306 ± 0.02
7500K	x = 0.298 ± 0.02
	y = 0.314 ± 0.02
6500K/sRGB	x = 0.313 ± 0.02

	$y = 0.329 \pm 0.02$
sRGB	$x = 0.313 \pm 0.02$
	$y = 0.329 \pm 0.02$
5000K	$x = 0.345 \pm 0.02$
	$y = 0.357 \pm 0.02$

Production alignment spec

CIE coordinates	(x,y)
11500K	$x = 0.270 \pm 0.005$
	$y = 0.281 \pm 0.005$
9300K	$x = 0.283 \pm 0.005$
	$y = 0.297 \pm 0.005$
8200K	$x = 0.291 \pm 0.005$
	$y = 0.306 \pm 0.005$
7500K	$x = 0.298 \pm 0.005$
	$y = 0.314 \pm 0.005$
6500K/sRGB	$x = 0.313 \pm 0.005$
	$y = 0.329 \pm 0.005$
sRGB	$x = 0.313 \pm 0.005$
	$y = 0.329 \pm 0.005$
5000K	$x = 0.345 \pm 0.005$
	$y = 0.357 \pm 0.005$

Quality Inspection specification

CIE coordinates	(x,y), FGA
9300K	$x = 0.283 \pm 0.015$
	$y = 0.297 \pm 0.015$
6500K/sRGB	$x = 0.313 \pm 0.015$
	$y = 0.329 \pm 0.015$
sRGB	$x = 0.313 \pm 0.015$
	$y = 0.329 \pm 0.015$

8.13 Distance between TFT LCD monitor and CRT/TFT monitor

Conducted with different modes or frequencies. No interference in a distance down to 25 cm.

9. ENVIRONMENT

9.1 Environmental characteristics

The following sections define the interference and susceptibility condition limits that might occur between external environment and the display device.

Operating

- Temperature : 0 to 35 degree C

- Humidity : 80% max
- Altitude : 0-3658m
- Air pressure : 600-1100 Mbar

Storage

- Temperature : -20 to 60 degree C
- Humidity : 95% max
- Altitude : 0-12192m
- Air pressure : 300-1100 mBAR

Note: recommend at 5 to 35°C, Humidity less than 60 %

10. REGULATORY STANDARDS

Note: All certificates must be raised under the name of Philips

10.1 Safety approvals

- CB report
- CE
- TUV GS
- TCO'03

10.2 Power management

- Energy Star

10.3 Certificates, Reports for the production start

When the first production of the monitor starts the following documents must be sent to Philips by mail. All reports must be raised under "Philips" and have to show W0ZR model name .

- CB report
- CE
- FCC
- Service manual

11 RELIABILITY**11.1 Reliability of the monitor**

The MTBF of the monitor has to be greater than 50.000 hours. The MTBF shall be calculated according to the MIL Standard HBKD 217 E/F. The report about the calculation detail shall be provided on component level before mass- production by TVI. The calculation shall be performed for a primary test/preset mode under ambient temperature of 25°C.

12. CUSTOMIZATION**12.1 Identity Customization**

Refer to SKU

12.2 EAN /SAP Identification

Refer to SKU

12.3 Plastic

The plastic material of the monitor must be PC-ABS (Front/ back) ABS-HB (base).
Plastic type and color is released as follows:

Refer to MakeUp sheet/ Graphic sheet

12.4 Definition of serial number

Refer to Philips' definition

12.5 Definition of the barcode label

Refer to Philips' definition

12.6 Accessories

Refer to SKU

13. ECR-HANDLING

Not any change without approved ECR.

Every ECR to the golden " samples" must be approved by PHILIPS, Even ECR for minor changes must be released by PHILIPS.

For the ECR procedure the vendor has to send an ECR formular, necessary spec updates, datasheets and a photo documentation. On based on documents, PHILIPS has to decide if samples are necessary till release to changes. The vendor also has to proof be certificates and test reports, that the change has no effect on safety, EMI and TCO03.

After testing, PHILIPS has to release or reject the change request.

Safety Check Process

Safety Checks

After the original service problem has been corrected, a complete safety check should be made. Be sure to check over the entire set, not just the areas where you have worked. Some previous service may have left an unsafe condition, which could be unknowingly passed on to your customer. Be sure to check all of the following:

Fire and Shock Hazard

1. Be sure all components are positioned in such a way as to avoid the possibility of adjacent component shorts. This is especially important on those chassis which are transported to and from the service shop.
2. Never release a repaired unit unless all protective devices such as insulators, barriers, covers, strain reliefs, and other hardware have been installed in accordance with the original design.
3. Soldering and wiring must be inspected to locate possible cold solder joints, solder splashes, sharp solder points, frayed leads, pinched leads, or damaged insulation (including the accord). Be certain to remove loose solder balls and all other loose foreign particles.
4. Check across-the-line components and other components for physical evidence of damage or deterioration and replace if necessary. Follow original layout, lead length and dress.
5. No lead or component should touch a receiving tube or a resistor rated at 1 watt or more. Lead tension around protruding metal surfaces or edges must be avoided.
6. Critical components having special safety characteristics are identified with an asterisk by the Ref. No in the parts list and enclosed within a broken line * (Where several critical components are grouped in one area) along with the safety symbols on the schematic diagrams and/or exploded views.
7. When servicing any unit, always use a separate isolation transformer for the chassis failure to use a separate isolation transformer may expose you to possible shock hazard, and may cause damage to servicing instruments.
8. Many electronic products use a polarized ac line cord (one wide pin on the plug). Defeating this safety feature may create a potential hazard to the service and the user. Extension cords which do not incorporate the polarizing feature should never be used.
9. After reassembly of the unit, always perform a leakage test or resistance test from the line cord to all exposed metal parts of the cabinets. Also check all metal control shafts (with knobs removed), antenna terminals, handles, screws, etc. To be sure the unit may be safely operated without danger of electrical shock.

* Broken line

Implosion

1. All picture tubes used in current model receivers are equipped with an integral implosion system care should always be used, and safety glasses worn, whenever handling any picture tube. Avoid scratching or otherwise damaging the picture tube during installation.
2. Use only replacement tubes specified by the manufacturer.

X-radiation

1. Be sure procedures and instructions to all your service personnel cover the subject of X-radiation. Potential sources of X-rays in TV receivers are the picture tube and the high voltage circuits. The basic precaution which must be exercised is to keep the high voltage at the factory recommended level.
2. To avoid possible exposure to X-radiation and electrical shock, only the manufacturer's specified anode connectors must be used.
3. It is essential that the service technician has an accurate HV meter available at all times. The calibration of this meter should be checked periodically against a reference standard.
4. When the HV circuitry is operating properly there is no possibility of an X-radiation problem. High voltage should always be kept at the manufacturer's rated value—no higher—for optimum performance. Every time a color set is serviced, the brightness should be run up and while monitoring the HV with a meter to be certain that the HV is regulated correctly and does not exceed the specified value. We suggest that you and your technicians review test procedures so that HV regulation are always checked as a standard servicing procedure, and the reason for this prudent routine is clearly understood by everyone. It is important to use an accurate and reliable HV meter. It is recommended that the HV recorded on each customer's invoice, which will demonstrate a proper concern for the customer's safety.
5. When troubleshooting and making test measurements in a receiver with a problem of excessive high voltage, reduce the line voltage by means of a variac to bring the HV into acceptable limits while troubleshooting. Do not operate the chassis longer than necessary to locate the cause of the excessive HV.

6. New picture tubes are specifically designed to withstand higher operating voltages without creating undesirable X-radiation. It is strongly recommended that any shop test fixture which is to be used with the new higher voltage chassis be equipped with one of the new type tubes designed for this service. Addition of a permanently connected HV meter to the shop test fixture is advisable. The CRT types used in these new sets should never be replaced with any other types, as this may result in excessive X-radiation.
7. It is essential to use the specified picture tube to avoid a possible X-radiation problem.
8. Most TV receivers contain some types of emergency "Hold Down" circuit to prevent HV from rising to excessive levels in the presence of a failure mode. These various circuits should be understood by all technicians servicing them, especially since many hold down circuits are inoperative as long as the receiver performs normally.

Leakage Current Cold Check

1. Unplug the ac line cord and connect a jumper between the two prongs of the plug.
2. Turn on the power switch.
3. Measure the resistance value between the jumpered ac plug and all exposed cabinet parts of the receiver, such as screw heads, antennas, and control shafts. When the exposed metallic part has a return path to the chassis, the reading should be between 1 megohm and 5.2 megohms. When the exposed metal does not have a return path to the chassis, the reading must be infinity. Remove the jumper from the ac line cord.

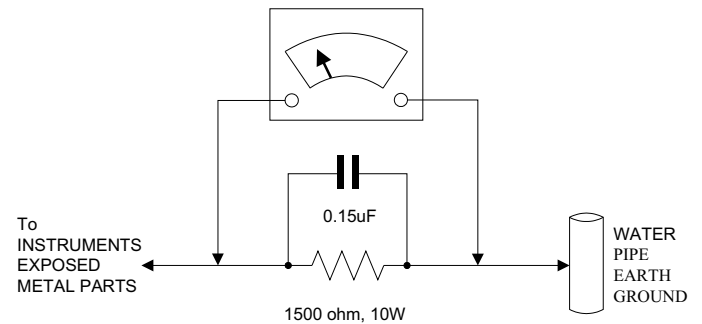

Leakage Current Hot Check

1. Do not use an isolation transformer for this test. Plug the completely reassembled receiver directly into the ac outlet.
2. Connect a 1.5k, 10W resistor paralleled by a 0.15uF capacitor between each exposed metallic cabinet part and a good earth ground such as a water pipe, as shown above.
3. Use an ac voltmeter with at least 5000 ohms volt sensitivity to measure the potential across the resistor.
4. The potential at any point should not exceed 0.75 volts. A leakage current tester may be used to make this test; leakage current must not exceed a possibility of shock hazard. The receiver should be repaired and rechecked before returning it to the customer.
5. Repeat the above procedure with the ac plug reversed. (note: an ac adapter is necessary when a polarized plug is used. Do not defeat the polarizing feature of the plug.)

Picture Tube Replacement

The primary source of X-radiation in this television receiver is the picture tube. The picture tube utilized in this chassis is specially constructed to limit X-radiation emissions. For continued X-radiation protection, the replacement tube must be the same types as the original, including suffix letter, or a Philips approved tube.

Parts Replacement

Many electrical and mechanical parts in Philips television sets have special safety related characteristics. These characteristics are often not evident from visual inspection nor can the protection afforded by them necessarily be obtained by using replacement components rated for higher voltage, wattage, etc. The use of a substitute part which does not have the same safety characteristics as the Philips recommended replacement part should in this service manual may create shock, fire, or other hazards.

WARNING: Before removing the back cover, turn the unit OFF and short the HIGH VOLTAGE to the ground.