

FAST SOFT RECOVERY RECTIFIER DIODE

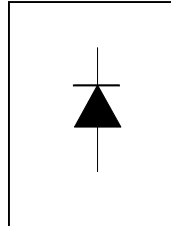

$$V_F < 1.2V @ 10A$$

$$t_{rr} = 50ns$$

$$V_{RRM} 200 \text{ to } 600V$$

Description/Features

The 10ETF..FP fast soft recovery *QUIETIR* rectifier series has been optimized for combined short reverse recovery time and low forward voltage drop.

The glass passivation ensures stable reliable operation in the most severe temperature and power cycling conditions.

Typical applications are both:

- output rectification and freewheeling in inverters, choppers and converters
- and input rectifications where severe restrictions on conducted EMI should be met.

Major Ratings and Characteristics

Characteristics	10ETF..FP	Units
$I_{F(AV)}$ Sinusoidal waveform	10	A
V_{RRM}	200 to 600	V
I_{FSM}	150	A
V_F @ 10A, $T_J = 25^\circ C$	1.2	V
t_{rr} @ 1A, 100A/ μs	50	ns
T_J	-40 to 150	$^\circ C$

Package Outline

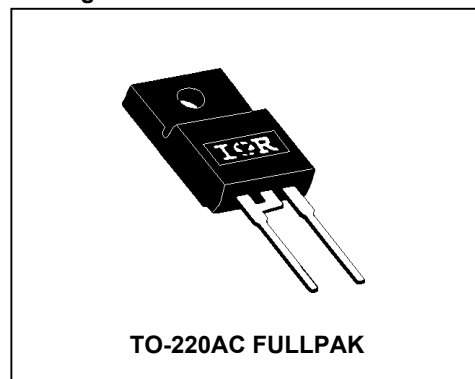

Voltage Ratings

Part Number	V_{RRM} , maximum peak reverse voltage V	V_{RSM} , maximum non repetitive peak reverse voltage V	I_{RRM} 150°C mA
10ETF02FP	200	300	2
10ETF04FP	400	500	
10ETF06FP	600	700	

Absolute Maximum Ratings

Parameters	10ETF..FP	Units	Conditions
$I_{F(AV)}$ Max. Average Forward Current	10	A	@ $T_c = 98^\circ\text{C}$, 180° conduction half sine wave
I_{FSM} Max. Peak One Cycle Non-Repetitive Surge Current	150	A	10ms Sine pulse, rated V_{RRM} applied
	160		10ms Sine pulse, no voltage reapplied
I^2t Max. I^2t for fusing	112.5	A^2s	10ms Sine pulse, rated V_{RRM} applied
	160		10ms Sine pulse, no voltage reapplied
$I^2\sqrt{t}$ Max. $I^2\sqrt{t}$ for fusing	1600	$A^2\sqrt{s}$	$t = 0.1$ to 10ms, no voltage reapplied

Electrical Specifications

Parameters	10ETF..FP	Units	Conditions
V_{FM} Max. Forward Voltage Drop	1.2	V	@ 10A, $T_j = 25^\circ\text{C}$
r_t Forward slope resistance	23.5	$m\Omega$	$T_j = 150^\circ\text{C}$
$V_{F(TO)}$ Threshold voltage	0.85	V	
I_{RM} Max. Reverse Leakage Current	0.1	mA	$T_j = 25^\circ\text{C}$
	3.0		$T_j = 150^\circ\text{C}$

$V_R = \text{rated } V_{RRM}$

Recovery Characteristics

Parameters	10ETF..FP	Units	Conditions
t_{rr} Reverse Recovery Time	145	ns	$I_F @ 10A_{pk}$
I_{rr} Reverse Recovery Current	2.75	A	@ 25A/ μs
Q_{rr} Reverse Recovery Charge	0.32	μC	@ 25°C
S Snap Factor	0.6		

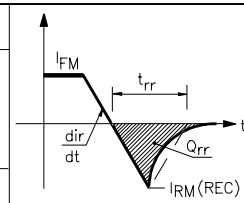

Thermal-Mechanical Specifications

Parameters	10ETF..FP	Units	Conditions
T _J Max. Junction Temperature Range	-40 to 150	°C	
T _{stg} Max. Storage Temperature Range	-40 to 150	°C	
R _{thJC} Max. Thermal Resistance Junction to Case	2.5	°C/W	DC operation
R _{thJA} Max. Thermal Resistance Junction to Ambient	62	°C/W	
R _{thCS} Typical Thermal Resistance, Case to Heatsink	0.5	°C/W	Mounting surface, smooth and greased
wt Approximate Weight	2 (0.07)	g (oz.)	
T Mounting Torque	Min.	6 (5)	Kg-cm (lbf-in)
	Max.	12 (10)	
Case Style	TO-220ACFULLPAK		(94/V0)

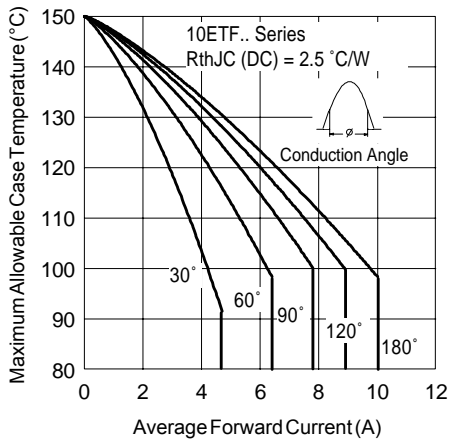

Fig. 1 - Current Rating Characteristics

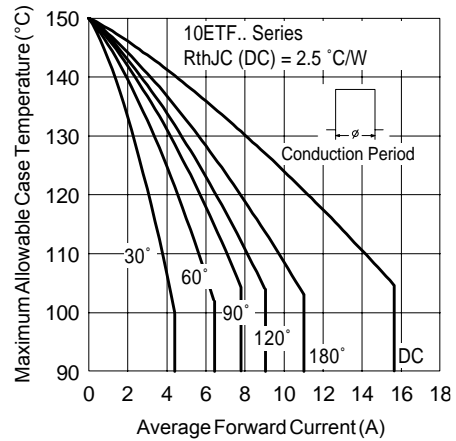

Fig. 2 - Current Rating Characteristics

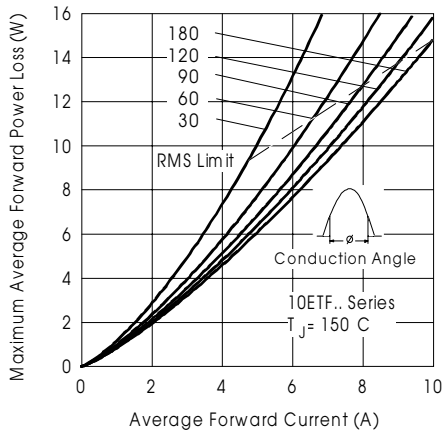

Fig. 3 - Forward Power Loss Characteristics

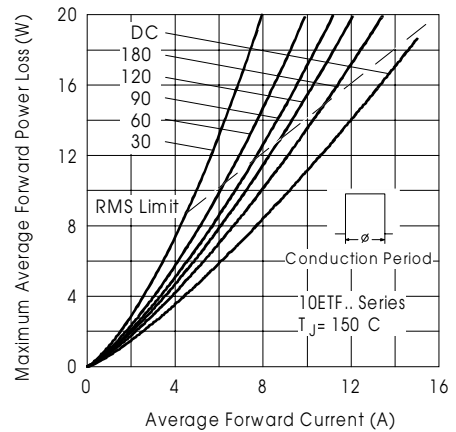

Fig. 4 - Forward Power Loss Characteristics

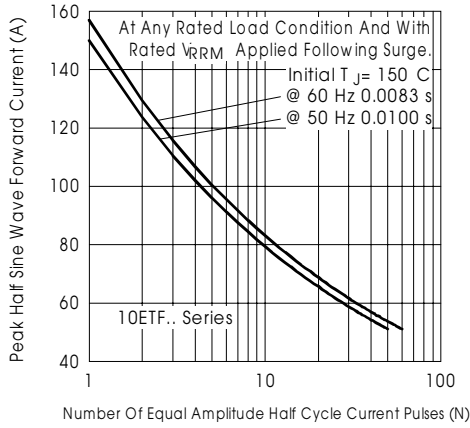

Fig. 5 - Maximum Non-Repetitive Surge Current

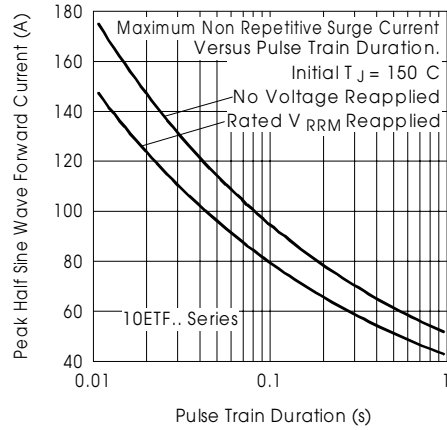

Fig. 6 - Maximum Non-Repetitive Surge Current

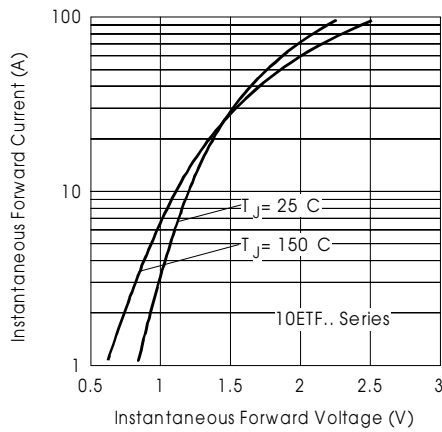

Fig. 7 - Forward Voltage Drop Characteristics

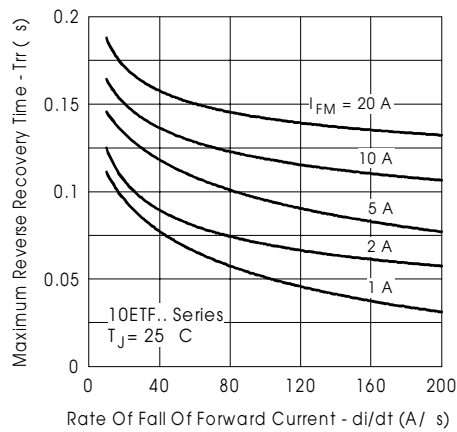

Fig. 8 - Recovery Time Characteristics, $T_J = 25^\circ\text{C}$

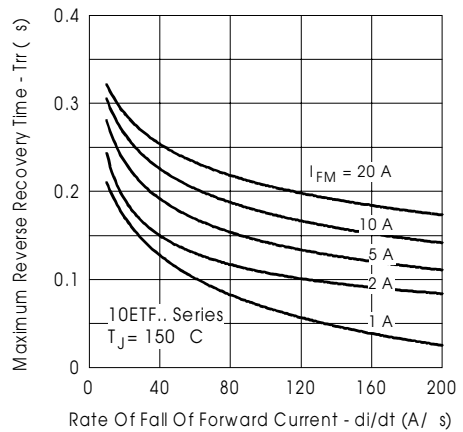

Fig. 9 - Recovery Time Characteristics, $T_J = 150^\circ\text{C}$

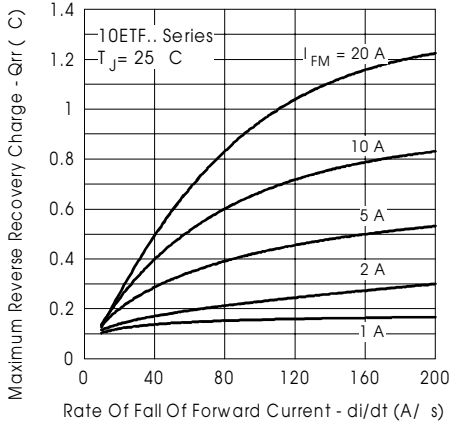

Fig. 10 - Recovery Charge Characteristics, $T_J = 25^\circ\text{C}$

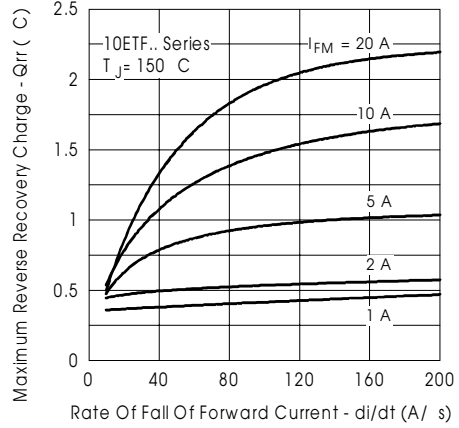

Fig. 11 - Recovery Charge Characteristics, $T_J = 150^\circ\text{C}$

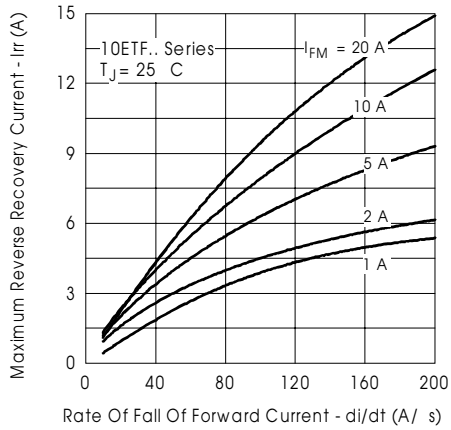

Fig. 12 - Recovery Current Characteristics, $T_J = 25^\circ\text{C}$

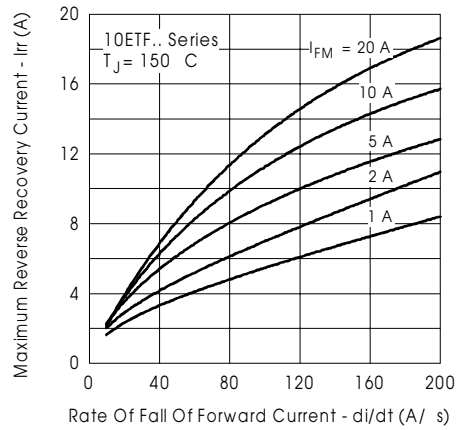

Fig. 13 - Recovery Current Characteristics, $T_J = 150^\circ\text{C}$

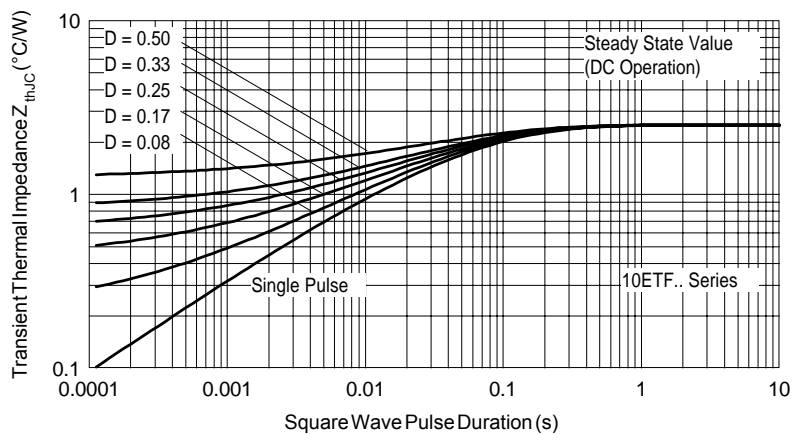

Fig. 14 - Thermal Impedance Z_{thjC} Characteristics

10ETF..FP QUIETIR Series

Bulletin I2163 04/02

International
IR Rectifier

Outline Table

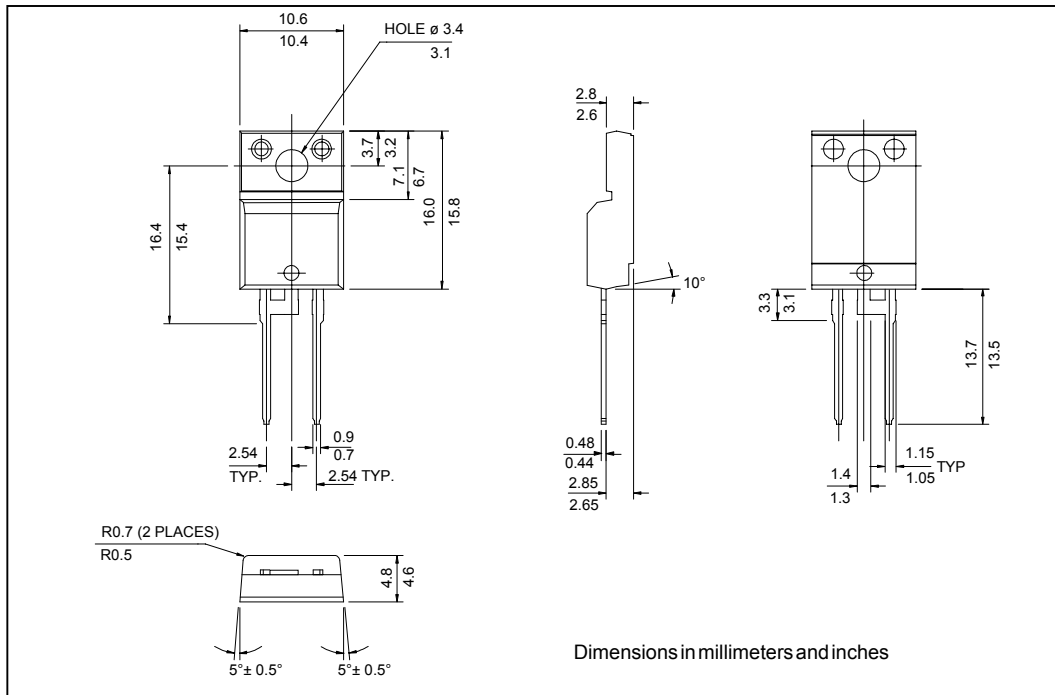

Ordering Information Table

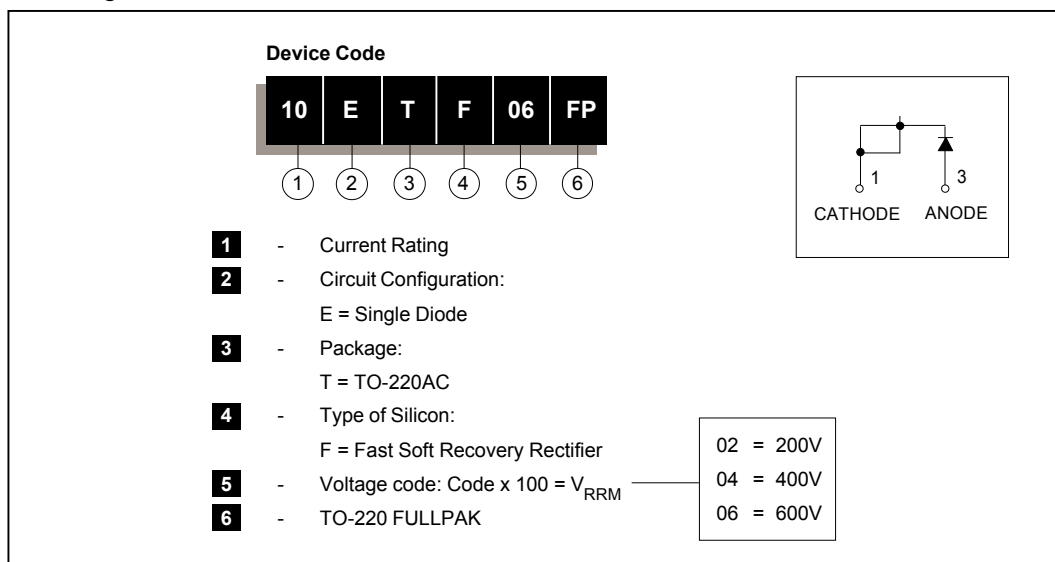

Data and specifications subject to change without notice.
This product has been designed and qualified for Industrial Level.
Qualification Standards can be found on IR's Web site.

International
IOR Rectifier

IR WORLD HEADQUARTERS: 233 Kansas St., El Segundo, California 90245, USA Tel: (310) 252-7105
TAC Fax: (310) 252-7309
Visit us at www.irf.com for sales contact information. 04/02