

2-CHANNEL ELECTRONIC VOLUME WITH INPUT SELECTOR

■ GENERAL DESCRIPTION

NJW1156A is a two channel electronic volume with 5 input selector. It's suitable for Input signal trimmer of audio equipments such as DVD / HDD recorder and VCR. These functions are controlled by I²C Bus.

NJW1156A changes high input impedance (38.5kΩ) compared with NJW1156.

■ PACKAGE OUTLINE

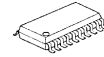

NJW1156AV

■ FEATURES

- Operating Voltage 8 to 13V
- I²C Bus control
- 5 Input Selector
- Volume 0 to -39.5dB/0.5dBstep, MUTE
- Bi-CMOS Technology
- Package Outline SSOP20

■ BLOCK DIAGRAM

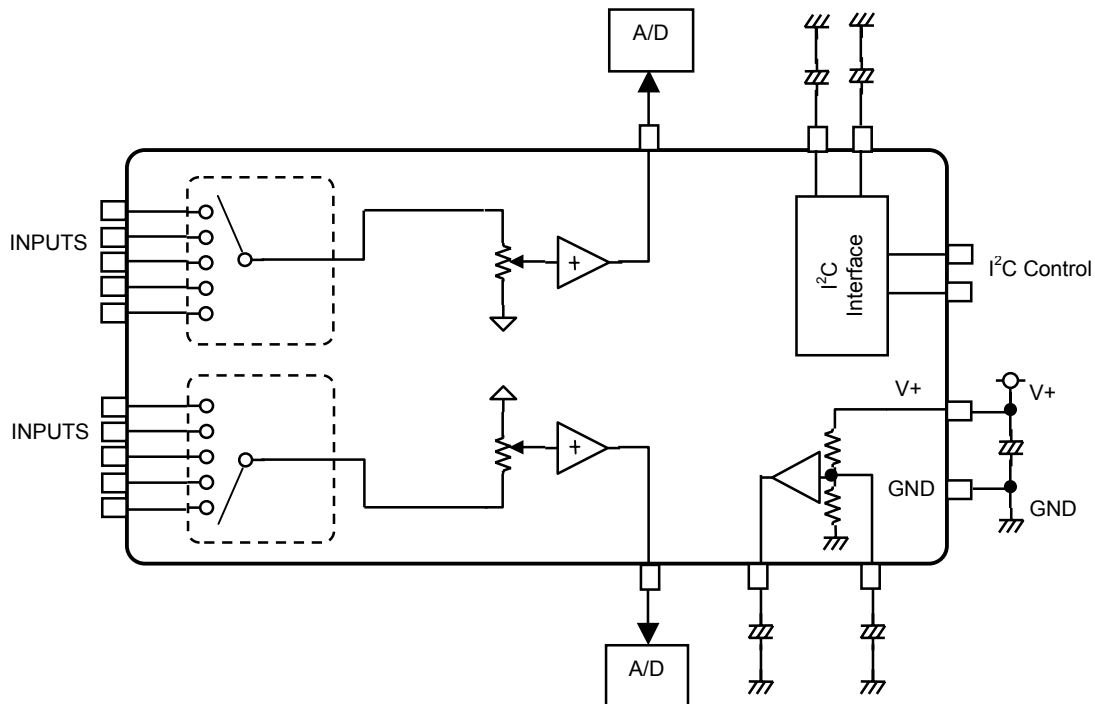

■ PIN FUNCTION

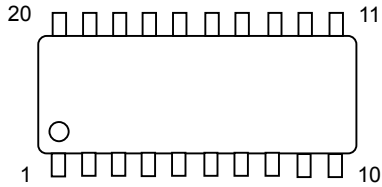

No.	SYMBOL	FUNCTION
1	GND	Ground
2	R1IN	R channel Input 1
3	R2 IN	R channel Input 2
4	R3IN	R channel Input 3
5	R4IN	R channel Input 4
6	R5IN	R channel Input 5
7	ROUT	R channel Output
8	VSSOUT	Internal VSS Noise Rejection Capacitor Terminal
9	SCL	I ² C Clock Input
10	SDA	I ² C Data Input
11	VDDOUT	Internal VDD Noise Rejection Capacitor Terminal
12	VREFOUT	Reference Voltage Output
13	V+	Power Supply
14	VREFIN	Reference Voltage Noise Rejection Capacitor Terminal
15	LOUT	L channel Output
16	L5IN	L channel Input 5
17	L4IN	L channel Input 4
18	L3IN	L channel Input 3
19	L2IN	L channel Input 2
20	L1IN	L channel Input 1

■ ABSOLUTE MAXIMUM RATING (Ta=25°C)

PARAMETER	SYMBOL	RATING	UNIT
Power Supply Voltage	V+	15	V
Power Dissipation	P _D	300	mW
Operating Temperature Range	Topr	-20 to +75	°C
Storage Temperature Range	Tstg	-40 to +125	°C

■ ELECTRICAL CHARACTERISTICS (Ta=25°C, V⁺=+12V)

PARAMETER	SYMBOL	TEST CONDITION	MIN.	TYP.	MAX.	UNIT
◆ Power Supply						
Operating Voltage	V+	-	8	12	13	V
Reference Voltage	V _{ref}	-	5.5	6	6.5	V
Supply Current	I _{CC}	No signal	-	4.5	6.8	mA
◆ Input/Output Characteristics						
Maximum Output Voltage	V _{OM}	f=1kHz, THD=1% Volume=0dB	3.0	4.0	-	V _{rms}
Voltage Gain 1	G _{V1}	V _{IN} =1V _{rms} , f=1kHz Volume=0dB	-0.5	0	0.5	dB
Voltage Gain 2	G _{V2}	V _{IN} =1V _{rms} , f=1kHz Volume=-20dB	-21	-20	-19	dB
Voltage Gain 3	G _{V3}	V _{IN} =1V _{rms} , f=1kHz Volume=-39.5dB	-42.0	-39.5	-37.0	dB
Voltage Gain Error	ΔG _V	V _{IN} =1V _{rms} , f=1kHz Volume=-20dB, Ach - Bch	-0.5	0	0.5	dB
Mute Level	Mute	f=1kHz, V _{IN} =1V _{rms} Volume=Mute, A-weight	-	-100	-	dB
Output Noise	V _{NO}	Volume=0dB, Rg=0, A-weight	-	-110 (3.2μ)	-100 (10μ)	dBV (V _{rms})
Total Harmonic Distortion	THD	f=1kHz, V _o =1V _{rms} , Volume=0dB BW : 400Hz - 30kHz	-	0.0015	0.05	%
Channel Separation	CS	f=1kHz, V _o =1V _{rms} , Volume=0dB Rg=0Ω, A-weight	-	-100	-90	dB

■ I²C BUS BLOCK CHARACTERISTICS (SDA,SCL)

PARAMETER	SYMBOL	MIN.	TYP.	MAX.	UNIT
High Level Input Voltage	V _{IH}	2.5	-	5.0	V
Low Level Input Voltage	V _{IL}	0	-	1.5	V
High Level Input Current	I _{IH}	-	-	10	μA
Low Level Input Current	I _{IL}	-	-	10	μA
Low Level Output Voltage (3mA at SDA pin)	V _{OL}	0	-	0.4	V
Maximum Output Current	I _{OL}	-3.0	-	-	mA
Maximum Clock Frequency	f _{SCL}	-	-	100	kHz
Data Change Minimum Waiting Time	t _{BUF}	4.7	-	-	μs
Data Transfer Start Minimum Waiting Time	t _{HD:STA}	4.0	-	-	μs
Low Level Clock Pulse Width	t _{LOW}	4.7	-	-	μs
High Level Clock Pulse Width	t _{HIGH}	4.0	-	-	μs
Minimum Start Preparation Waiting Time	t _{SU:STA}	4.7	-	-	μs
Minimum Data Hold Time	t _{HD:DAT}	0	-	3.45	μs
Minimum Data Preparation Time	t _{SU:DAT}	250	-	-	ns
Rise Time	t _R	-	-	1.0	μs
Fall Time	t _F	-	-	300	ns
Minimum Stop Preparation Waiting Time	t _{SU:STO}	4.0	-	-	μs

I²C BUS Load Condition: Pull up resistance 4kΩ (Connected to +5V)
Load capacitance 200pF (Connected to GND)

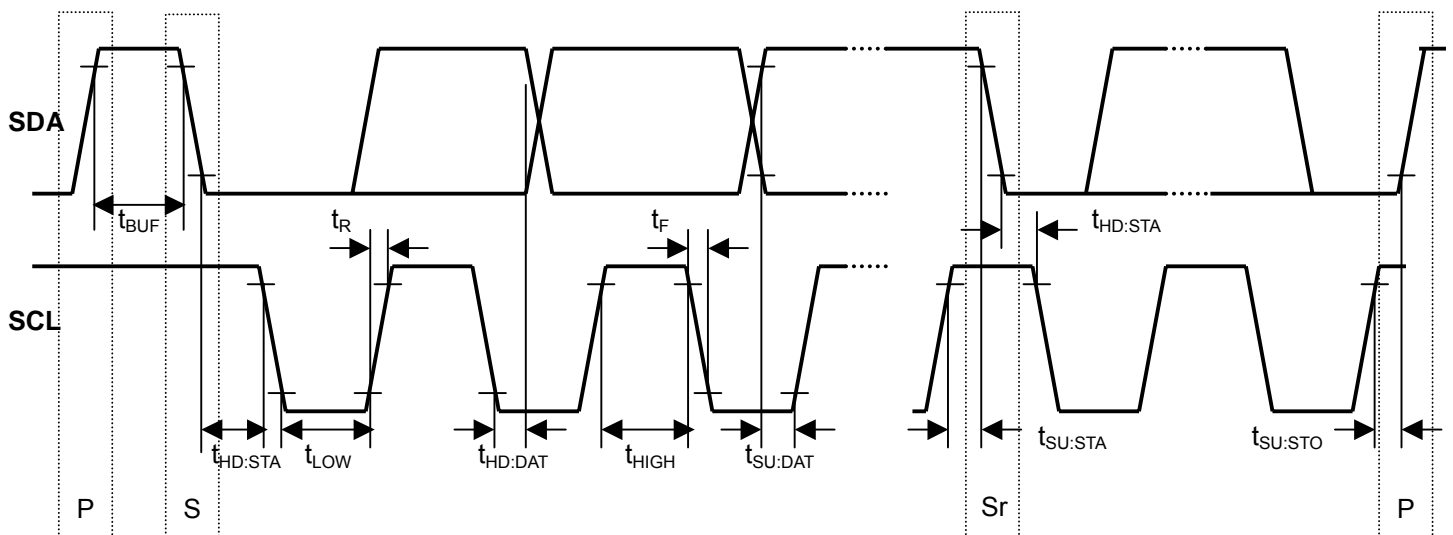

■ TERMINAL DESCRIPTION

PIN NO.	SYMBOL	FUNCTION	EQUIVALENT CIRCUIT	TERMINAL DC VOLTAGE
2 3 4 5 6 16 17 18 19 20	R1IN R2IN R3IN R4IN R5IN L5IN L4IN L3IN L2IN L1IN	R channel Input 1 R channel Input 2 R channel Input 3 R channel Input 4 R channel Input 5 L channel Input 5 L channel Input 4 L channel Input 3 L channel Input 2 L channel Input 1		$V^+/2$
7 15	ROUT LOUT	Rch Output Lch Output		$V^+/2$
8 11	VSS_OUT VDD_OUT	Internal VSS Noise Rejection Capacitor Terminal Internal VDD Noise Rejection Capacitor Terminal		$VSS_OUT = V_{ref} - 2.5V$ $VDD_OUT = V_{ref} + 2.5V$
9	SCL	I ² C Clock Input		-

■ TERMINAL DESCRIPTION

PIN NO.	SYMBOL	FUNCTION	EQUIVALENT CIRCUIT	TERMINAL DC VOLTAGE
10	SDA	I ² C Data Input		-
12	VREFOUT	Reference Voltage Output		V ⁺ /2
13	V+	Power Supply		V ⁺
14	VREFIN	Reference Voltage Noise Rejection Capacitor Terminal		V ⁺ /2

NJW1156A

www.DataSheet4U.com

APPLICATION CIRCUIT

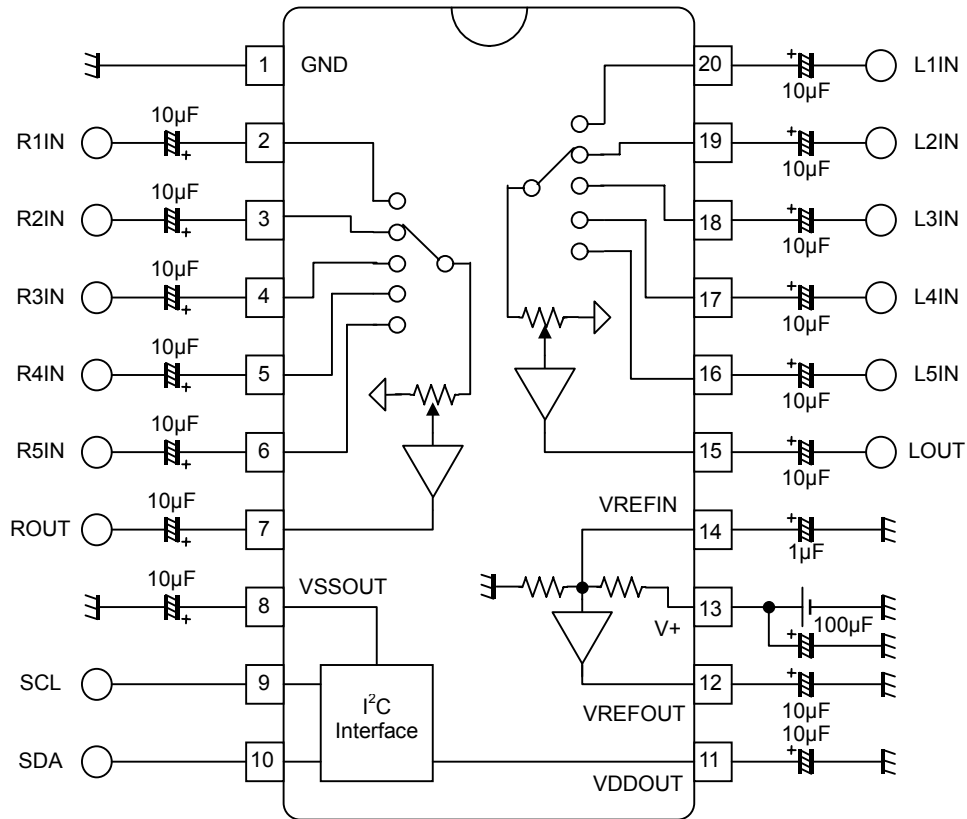

■ DEFINITION OF I²C REGISTER

◆ I²C BUS FORMAT

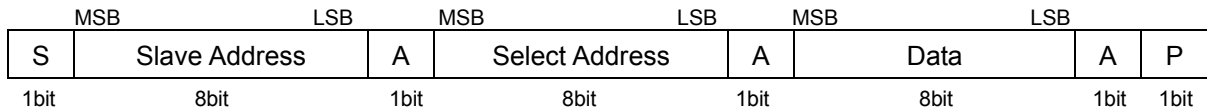

S: Starting Term
A: Acknowledge Bit
P: Ending Term

◆ SLAVE ADDRESS

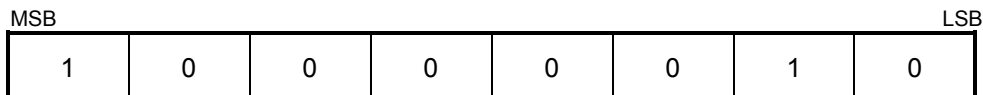

◆ CONTROL REGISTER TABLE

The select address sets each function (Volume, Selector).
The auto increment function cycles the select address as follows.
00H→01H→02H→00H

Select Address	BIT							
	D7	D6	D5	D4	D3	D2	D1	D0
00H	Don't Care	VOL-L						
01H	Don't Care	VOL-R						
02H	Don't Care	TEST		Don't Care		Selector		

◆ CONTROL REGISTER DEFAULT VALUE

Control register default values are as follows :

Select Address	BIT							
	D7	D6	D5	D4	D3	D2	D1	D0
00H	1	1	1	1	1	1	1	1
01H	1	1	1	1	1	1	1	1
02H	0	0	0	0	0	0	0	0

■ CONTROL COMMAND TABLE

a) Master Volume

Select Address	BIT							
	D7	D6	D5	D4	D3	D2	D1	D0
00H	Don't Care	VOL-L						
01H	Don't Care	VOL-R						

•VOL-L / VOL-R: Lch and Rch volume level setting from 0dB to -39.5dB with 0.5dB step.

Gain (dB)	VOL-L / VOL-R						
	D6	D5	D4	D3	D2	D1	D0
0	0	0	0	0	0	0	0
-0.5	0	0	0	0	0	0	1
-1	0	0	0	0	0	1	0
-1.5	0	0	0	0	0	1	1
-2	0	0	0	0	1	0	0
-2.5	0	0	0	0	1	0	1
-3	0	0	0	0	1	1	0
-3.5	0	0	0	0	1	1	1
-4	0	0	0	1	0	0	0
-4.5	0	0	0	1	0	0	1
-5	0	0	0	1	0	1	0
-5.5	0	0	0	1	0	1	1
-6	0	0	0	1	1	0	0
-6.5	0	0	0	1	1	0	1
-7	0	0	0	1	1	1	0
-7.5	0	0	0	1	1	1	1
-8	0	0	1	0	0	0	0
-8.5	0	0	1	0	0	0	1
-9	0	0	1	0	0	1	0
-9.5	0	0	1	0	0	1	1
-10	0	0	1	0	1	0	0
-10.5	0	0	1	0	1	0	1
-11	0	0	1	0	1	1	0
-11.5	0	0	1	0	1	1	1
-12	0	0	1	1	0	0	0
-12.5	0	0	1	1	0	0	1
-13	0	0	1	1	0	1	0
-13.5	0	0	1	1	0	1	1
-14	0	0	1	1	1	0	0
-14.5	0	0	1	1	1	0	1
-15	0	0	1	1	1	1	0
-15.5	0	0	1	1	1	1	1
-16	0	1	0	0	0	0	0
-16.5	0	1	0	0	0	0	1
-17	0	1	0	0	0	1	0
-17.5	0	1	0	0	0	1	1
-18	0	1	0	0	1	0	0
-18.5	0	1	0	0	1	0	1
-19	0	1	0	0	1	1	0
-19.5	0	1	0	0	1	1	1
-20	0	1	0	1	0	0	0
...
-39.5	1	0	0	1	1	1	1
Mute	1	1	1	1	1	1	1

b) Input Selector

Select Address	BIT							
	D7	D6	D5	D4	D3	D2	D1	D0
02H	Don't Care	TEST		Don't Care		Selector		

- TEST : Test Mode(User Inhibit). The command "TEST"(D6, D5) must be "0".
- Selector : Input signal selecting

Input	Selector		
	D2	D1	D0
L1IN / R1IN	0	0	0
L2IN / R2IN	0	0	1
L3IN / R3IN	0	1	0
L4IN / R4IN	0	1	1
L5IN / R5IN	1	0	0

TYPICAL CHARACTERISTICS

Operating Current vs. Supply Voltage
Ta=25°C

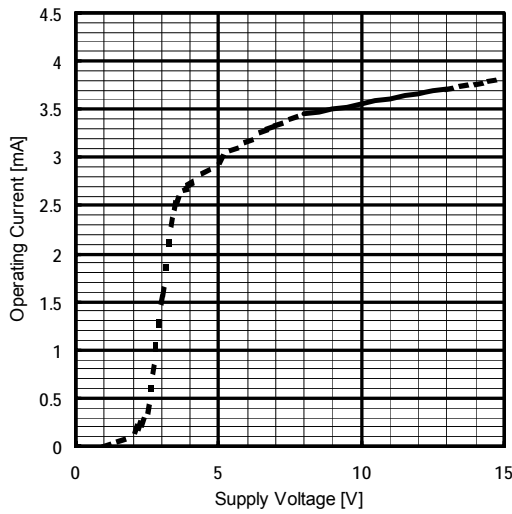

Voltage Gain vs. Attenuator Set Level
Ta=25°C

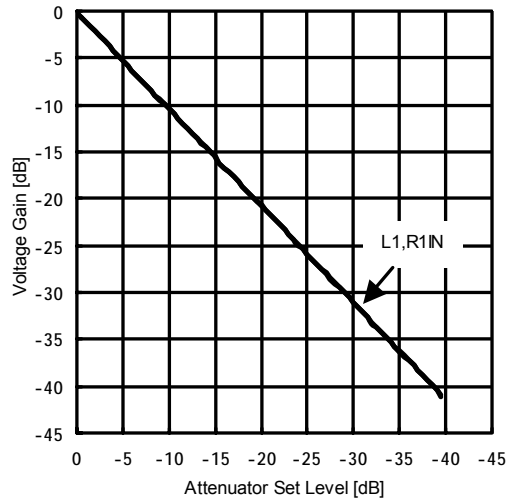

THD+N vs. Input Level
V+=12V, VOL=0dB, BW=10Hz-80kHz
INPUT:L1IN, OUTPUT:L1OUT

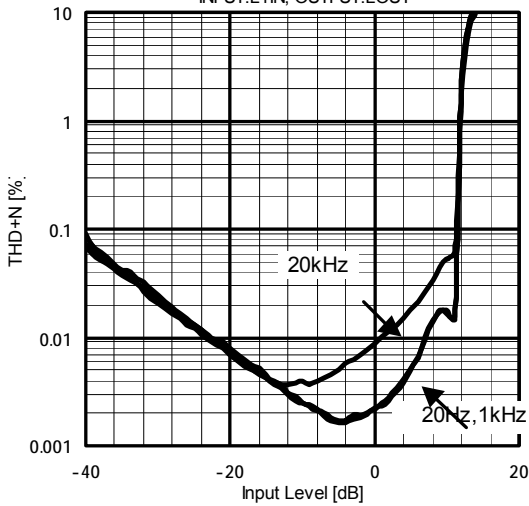

THD+N vs. Input Level
V+=12V, f=1kHz, BW=10Hz-80kHz
INPUT:L1IN, OUTPUT:L1OUT

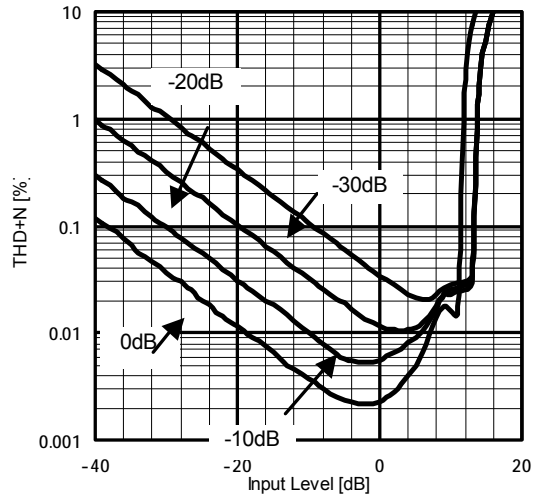

Operating Current vs. Supply Voltage

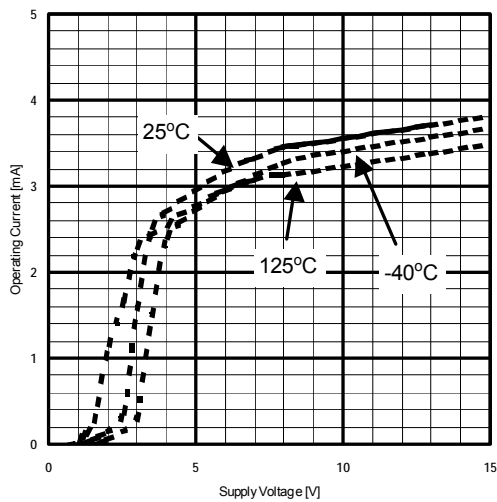

Operating Current vs. Ambient Temperature
V+=12V

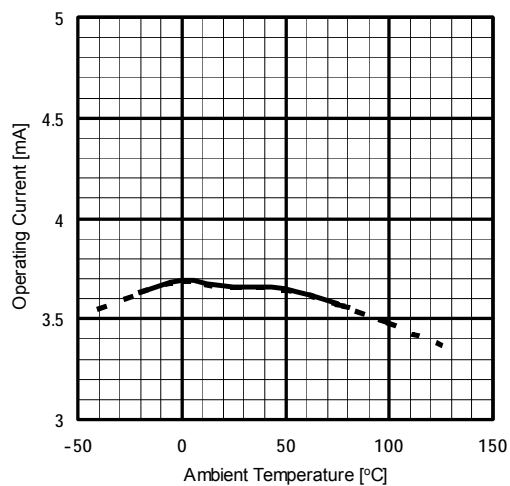

TYPICAL CHARACTERISTICS

Voltage Gain vs. Ambient Temperature
 $V^+=12V, V_{in}=1V, f=1kHz, Vol=0dB$

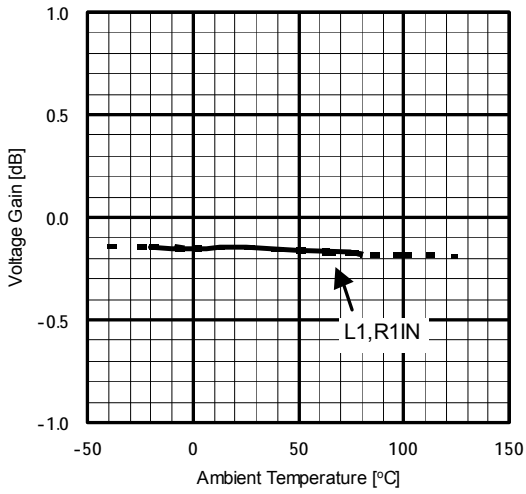

Attenuation Level vs. Ambient Temperature
 $V^+=12V, V_{in}=1V, f=1kHz, Vol=-20dB$

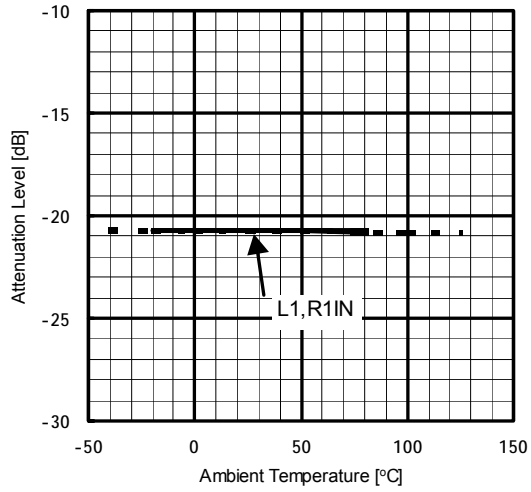

Attenuation Level vs. Ambient Temperature
 $V^+=12V, V_{in}=1V, f=1kHz, Vol=-39.5dB$

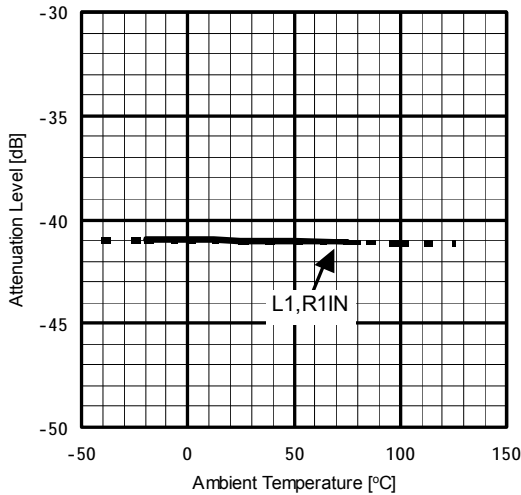

Attenuation Level vs. Ambient Temperature
 $V^+=12V, V_{in}=1V, f=1kHz, Vol=Mute$

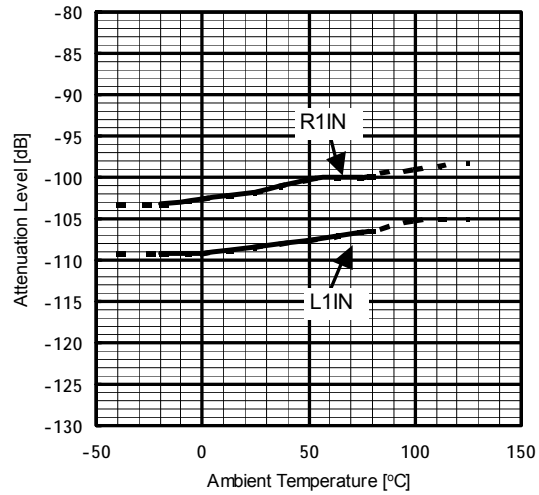

Maximum Output Voltage vs. Ambient Temperature
 $V^+=12V, f=1kHz, THD+N=1%, Vol=0dB$

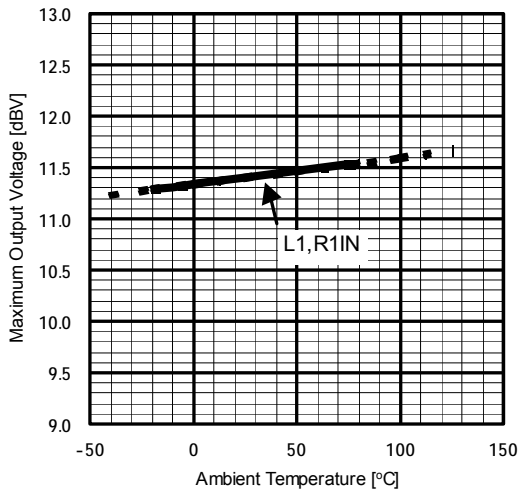

Output Noise Level vs. Ambient Temperature
 $V^+=12V, R_g=0\Omega, Vol=0dB, A-w eight$

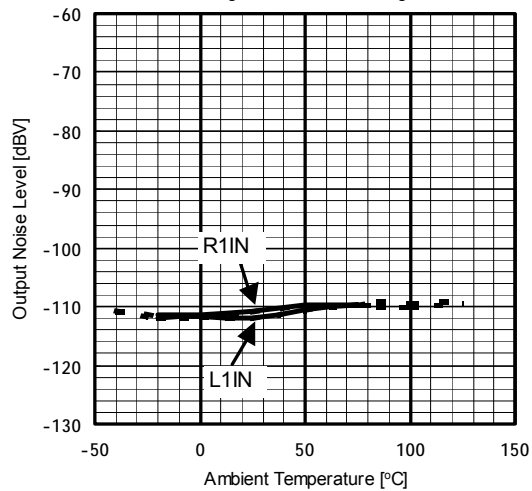

■ TYPICAL CHARACTERISTICS

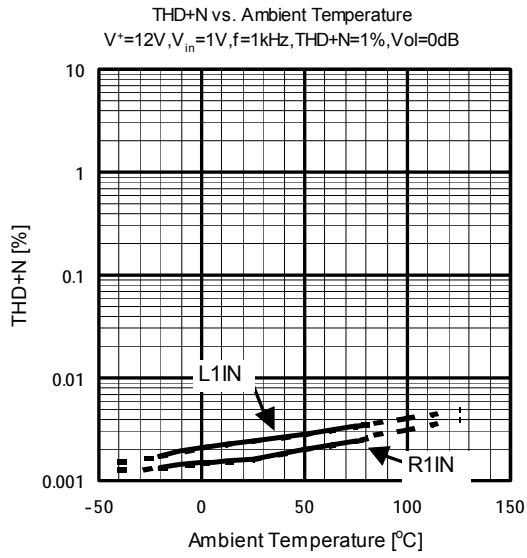

[CAUTION]
The specifications on this databook are only given for information, without any guarantee as regards either mistakes or omissions. The application circuits in this databook are described only to show representative usages of the product and not intended for the guarantee or permission of any right including the industrial rights.