

# SHINDENGEN

## Switching Power Transistor

FX Series

**2SC4582**  
**(TP15W45FX)****15A NPN**

### OUTLINE DIMENSIONS

Case : ITO-3P

Unit : mm

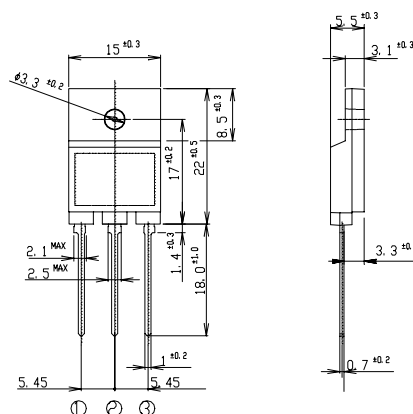

⊙: B  
 ⊖: C  
 ⊕: E

### RATINGS

#### ● Absolute Maximum Ratings

Item	Symbol	Conditions	Ratings	Unit
Storage Temperature	$T_{stg}$		-55 ~ 150	°C
Junction Temperature	$T_j$		150	°C
Collector to Base Voltage	$V_{CBO}$		600	V
Collector to Emitter Voltage	$V_{CEO}$		450	V
	$V_{CEX}$	$V_{EB} = 5V$	600	
Emitter to Base Voltage	$V_{EBO}$		7	V
Collector Current DC	$I_C$		15	A
Collector Current Peak	$I_{CP}$		30	
Base Current DC	$I_B$		6	A
Base Current Peak	$I_{BP}$		12	
Total Transistor Dissipation	$P_T$	$T_c = 25^\circ C$	75	W
Dielectric Strength	$V_{dis}$	Terminals to case, AC 1 minute	2	kV
Mounting Torque	TOR		0.8	N·m

#### ● Electrical Characteristics ( $T_c=25^\circ C$ )

Item	Symbol	Conditions	Ratings	Unit
Collector to Emitter Sustaining Voltage	$V_{CEO(sus)}$	$I_C = 0.2A$	Min 450	V
Collector Cutoff Current	$I_{CBO}$	At rated Voltage	Max 0.1	mA
	$I_{CEO}$		Max 0.1	
Emitter Cutoff Current	$I_{EBO}$	At rated Voltage	Max 0.1	mA
DC Current Gain	$h_{FE}$	$V_{CE} = 5V, I_C = 7.5A$	Min 10	
	$h_{FEL}$	$V_{CE} = 5V, I_C = 1mA$	Min 5	
Collector to Emitter Saturation Voltage	$V_{CE(sat)}$	$I_C = 7.5A$	Max 1.0	V
Base to Emitter Saturation Voltage	$V_{BE(sat)}$	$I_B = 1.5A$	Max 1.5	V
Thermal Resistance	$\theta_{jc}$	Junction to case	Max 1.67	°C/W
Transition Frequency	$f_T$	$V_{CE} = 10V, I_C = 1.5A$	STD 20	MHz
Turn on Time	$t_{on}$	$I_C = 7.5A$	Max 0.5	$\mu s$
Storage Time	$t_s$	$I_{B1} = 1.5A, I_{B2} = 3A$	Max 2.0	
Fall Time	$t_f$	$R_L = 20 \Omega, V_{BB2} = 4V$	Max 0.2	

# 2SC4582 $h_{FE} - I_C$

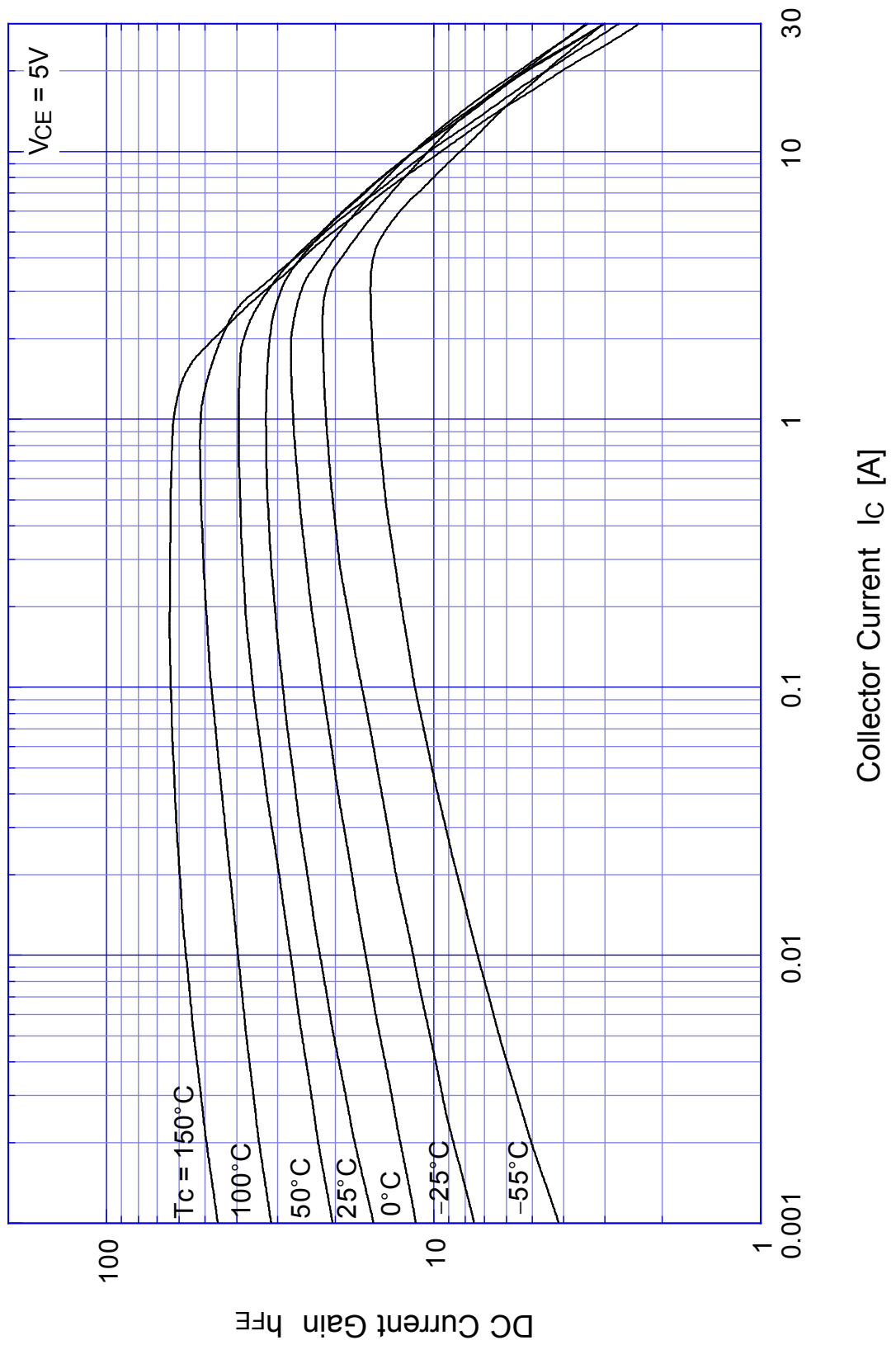

## 2SC4582 Saturation Voltage

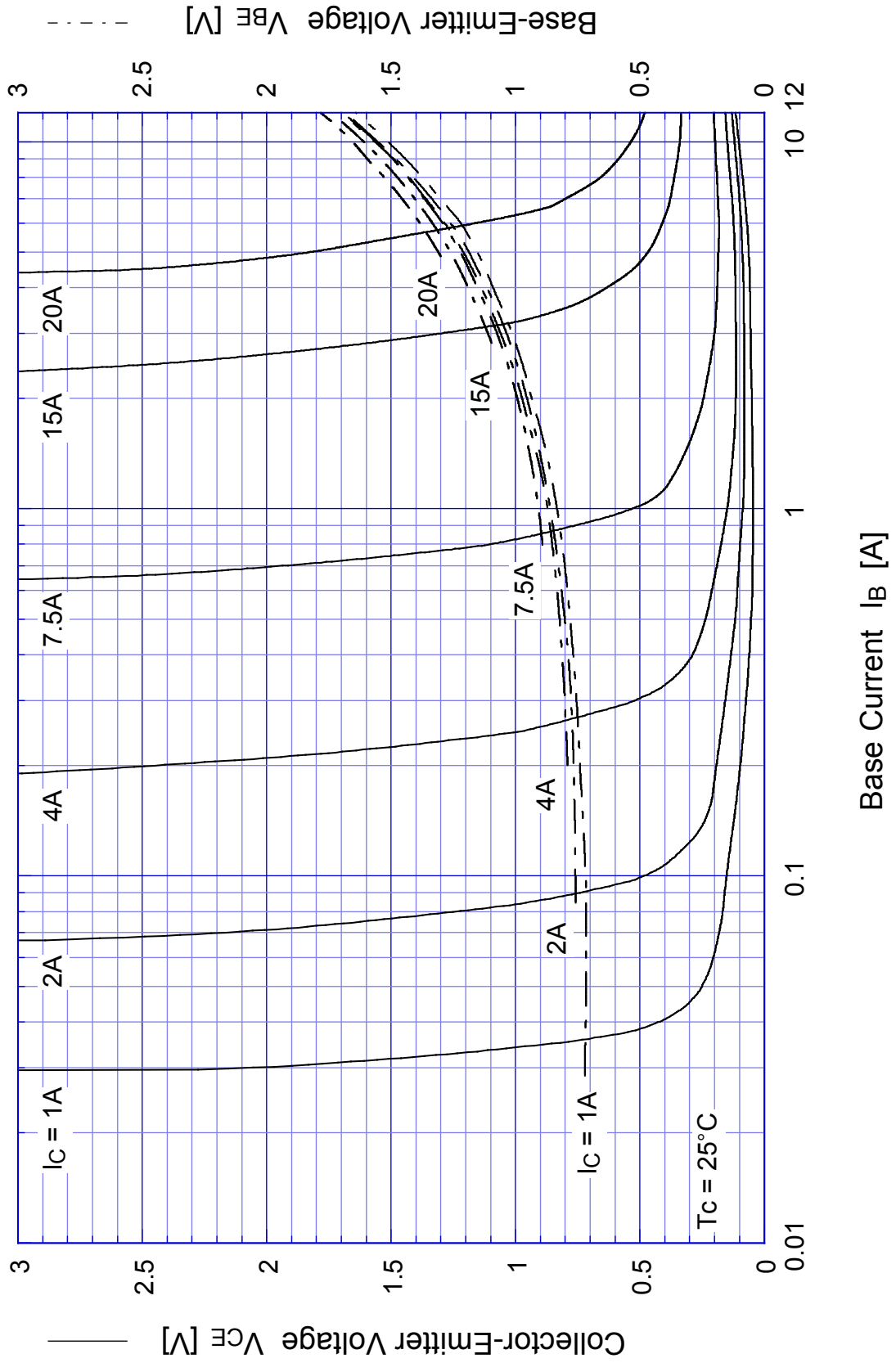

## 2SC4582      Switching Time - $I_C$

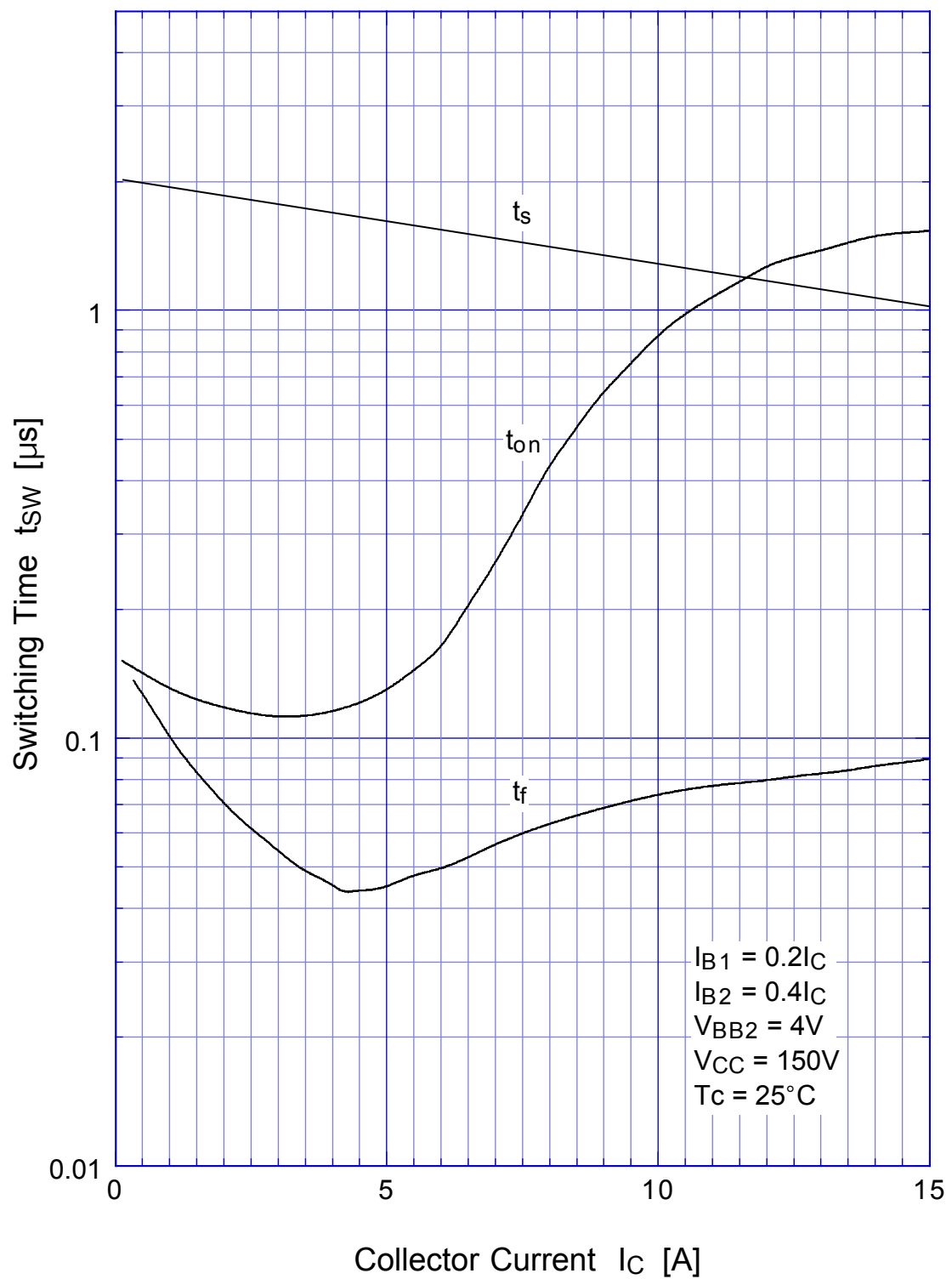

## 2SC4582 Switching Time - $V_{CC}$

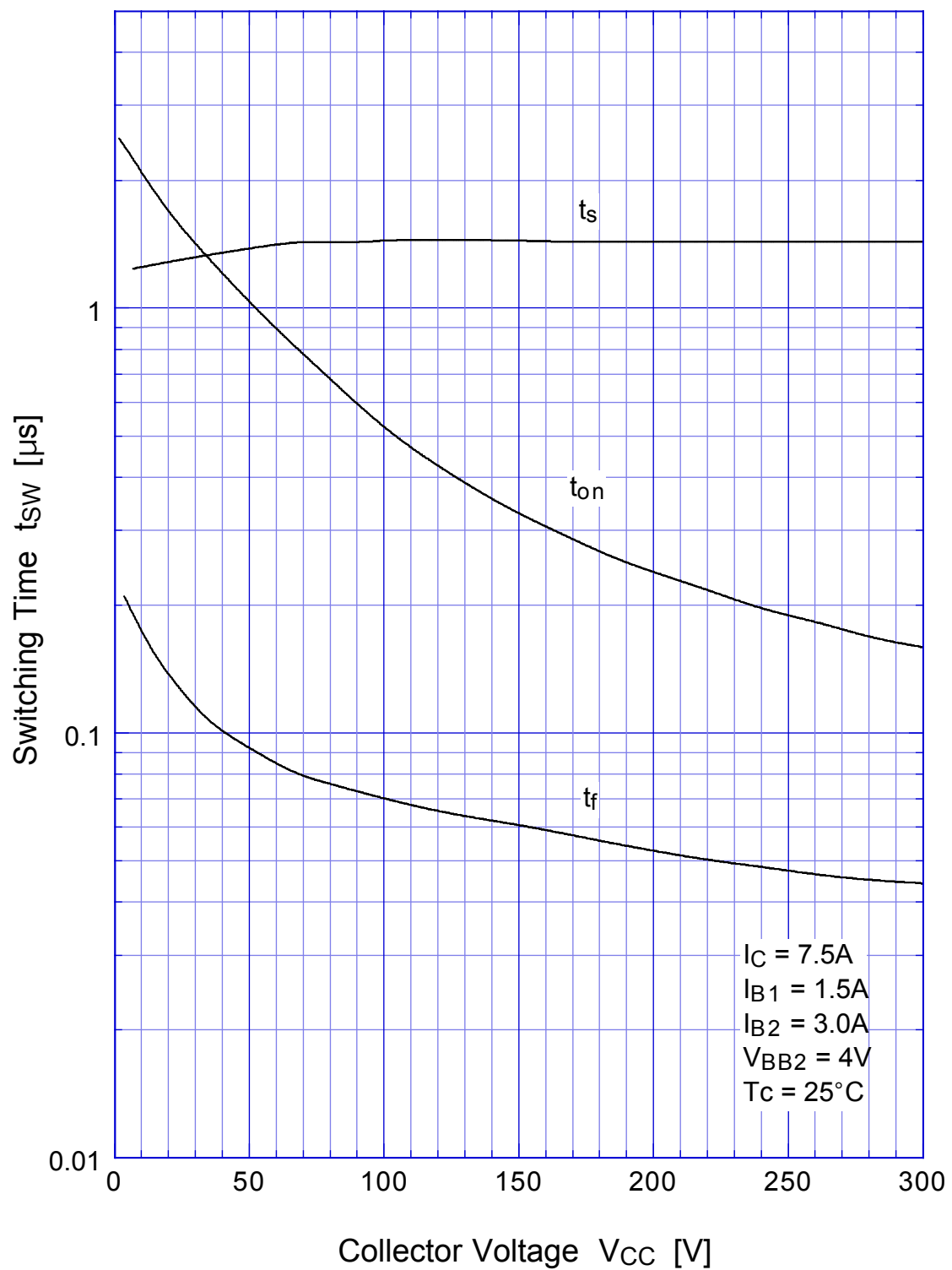

## 2SC4582 Switching Time - Tc

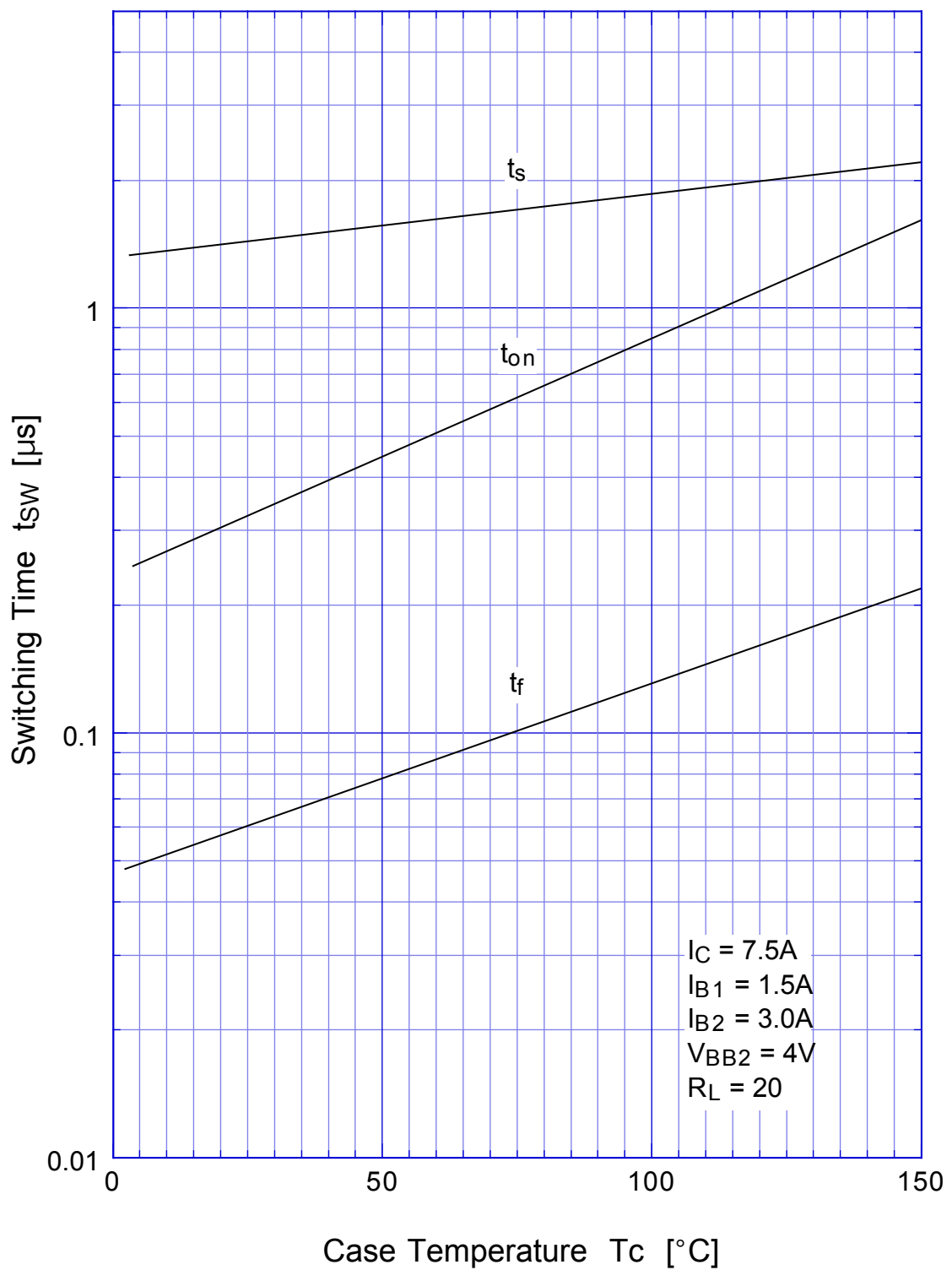

## 2SC4582 Transient Thermal Impedance

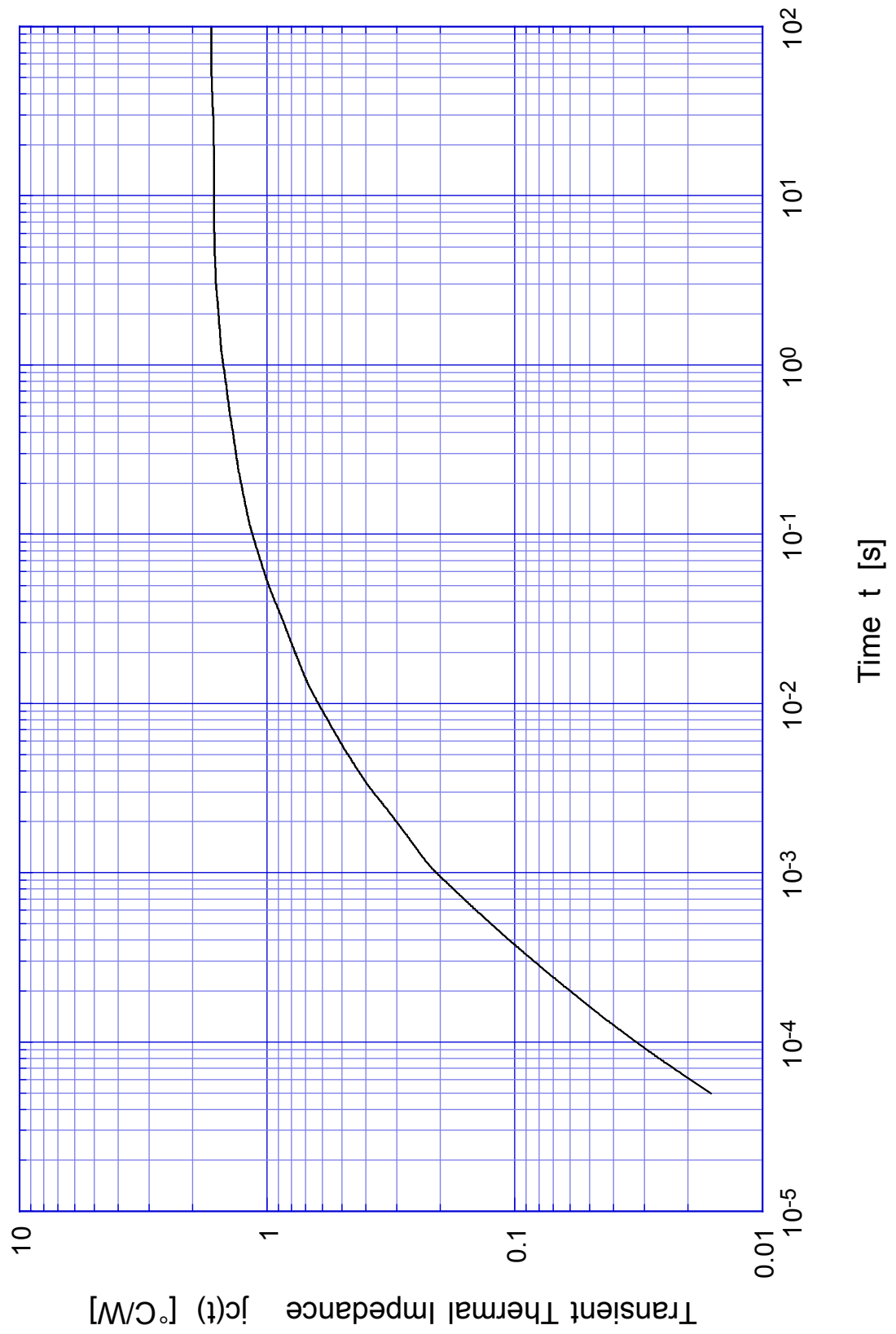

## 2SC4582 Forward Bias SOA

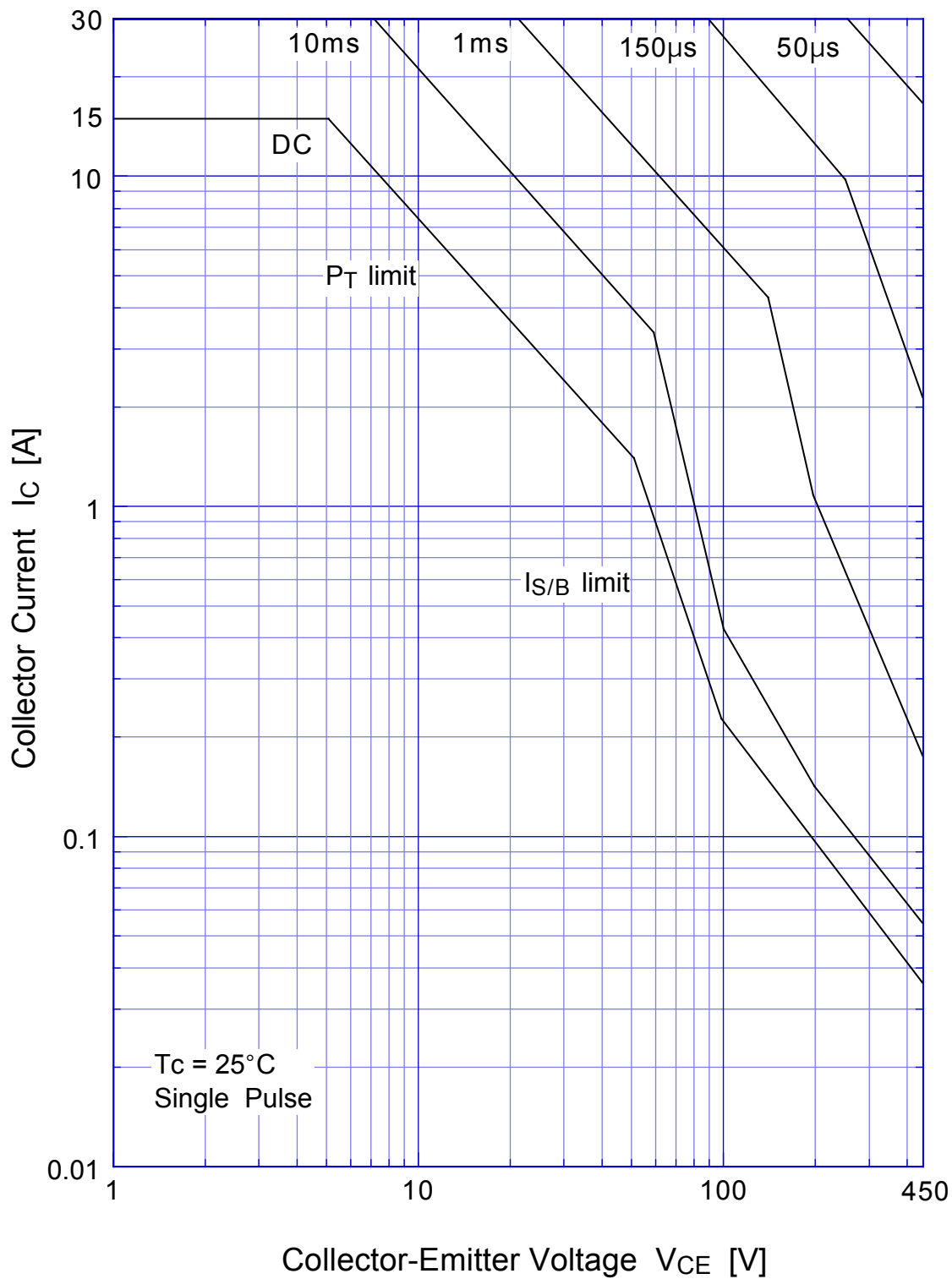



## 2SC4582 Collector Current Derating

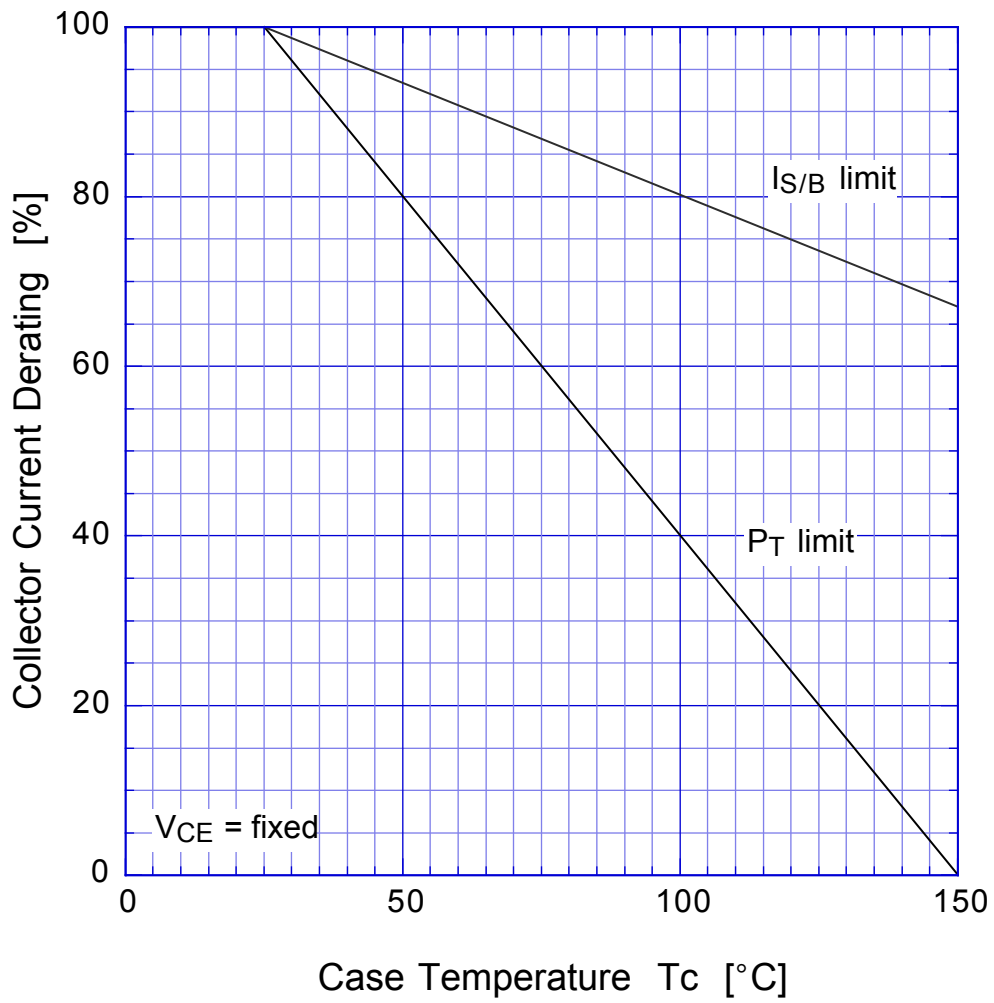

## 2SC4582 Reverse Bias SOA

