

UNR121x Series (UN121x Series)

Silicon NPN epitaxial planar type

For digital circuits

■ Features

- Costs can be reduced through downsizing of the equipment and reduction of the number of parts
- M type package allowing easy automatic and manual insertion as well as stand-alone fixing to the printed circuit board

■ Resistance by Part Number

	(R ₁)	(R ₂)
• UNR1210 (UN1210)	47 kΩ	—
• UNR1211 (UN1211)	10 kΩ	10 kΩ
• UNR1212 (UN1212)	22 kΩ	22 kΩ
• UNR1213 (UN1213)	47 kΩ	47 kΩ
• UNR1214 (UN1214)	10 kΩ	47 kΩ
• UNR1215 (UN1215)	10 kΩ	—
• UNR1216 (UN1216)	4.7 kΩ	—
• UNR1217 (UN1217)	22 kΩ	—
• UNR1218 (UN1218)	0.51 kΩ	5.1 kΩ
• UNR1219 (UN1219)	1 kΩ	10 kΩ
• UNR121D (UN121D)	47 kΩ	10 kΩ
• UNR121E (UN121E)	47 kΩ	22 kΩ
• UNR121F (UN121F)	4.7 kΩ	10 kΩ
• UNR121K (UN121K)	10 kΩ	4.7 kΩ
• UNR121L (UN121L)	4.7 kΩ	4.7 kΩ

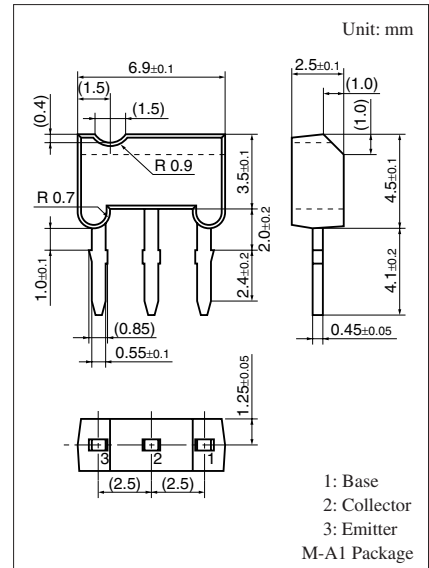

Internal Connection

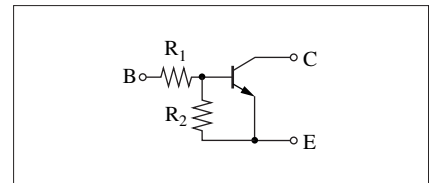

www.DataSheet4U.com

■ Absolute Maximum Ratings T_a = 25°C

Parameter	Symbol	Rating	Unit
Collector-base voltage (Emitter open)	V _{CBO}	50	V
Collector-emitter voltage (Base open)	V _{CEO}	50	V
Collector current	I _C	100	mA
Total power dissipation	P _T	400	mW
Junction temperature	T _j	150	°C
Storage temperature	T _{stg}	-55 to +150	°C

Note) The part numbers in the parenthesis show conventional part number.

■ Electrical Characteristics $T_a = 25^\circ\text{C} \pm 3^\circ\text{C}$

Parameter	Symbol	Conditions	Min	Typ	Max	Unit	
Collector-base voltage (Emitter open)	V_{CBO}	$I_C = 10 \mu\text{A}, I_E = 0$	50			V	
Collector-emitter voltage (Base open)	V_{CEO}	$I_C = 2 \text{ mA}, I_B = 0$	50			V	
Collector-base cutoff current (Emitter open)	I_{CBO}	$V_{CB} = 50 \text{ V}, I_E = 0$			0.1	μA	
Collector-emitter cutoff current (Base open)	I_{CEO}	$V_{CE} = 50 \text{ V}, I_B = 0$			0.5	μA	
Emitter-base cutoff current (Collector open)	UNR1211	I_{EBO}	$V_{EB} = 6 \text{ V}, I_C = 0$			0.5	mA
	UNR1212/1214/121D/121E					0.2	
	UNR1213					0.1	
	UNR1210/1215/1216/1217					0.01	
	UNR121F/121K					1.0	
	UNR1219					1.5	
	UNR1218/121L					2.0	
Forward current transfer ratio	UNR1211	h_{FE}	$V_{CE} = 10 \text{ V}, I_C = 5 \text{ mA}$	35			—
	UNR1212/121E			60			
	UNR1213/1214			80			
	UNR1210*/1215*/1216*/1217*			160		460	
	UNR1219/121D/121F			30			
	UNR1218/121K/121L			20			
Collector-emitter saturation voltage	$V_{CE(sat)}$	$I_C = 10 \text{ mA}, I_B = 0.3 \text{ mA}$			0.25	V	
Output voltage high-level	V_{OH}	$V_{CC} = 5 \text{ V}, V_B = 0.5 \text{ V}, R_L = 1 \text{ k}\Omega$	4.9			V	
Output voltage low-level	V_{OL}	$V_{CC} = 5 \text{ V}, V_B = 2.5 \text{ V}, R_L = 1 \text{ k}\Omega$			0.2	V	
		$V_{CC} = 5 \text{ V}, V_B = 3.5 \text{ V}, R_L = 1 \text{ k}\Omega$					
		$V_{CC} = 5 \text{ V}, V_B = 10 \text{ V}, R_L = 1 \text{ k}\Omega$					
		$V_{CC} = 5 \text{ V}, V_B = 6 \text{ V}, R_L = 1 \text{ k}\Omega$					
Transition frequency	f_T	$V_{CB} = 10 \text{ V}, I_E = -2 \text{ mA}, f = 200 \text{ MHz}$		80		MHz	
Input resistance	UNR1211/1214/1215/121K	R_1		-30%	10	+30%	k Ω
	UNR1212/1217				22		
	UNR1210/1213/121D/121E				47		
	UNR1216/121F/121L				4.7		
	UNR1218				0.51		
	UNR1219				1		
Resistance ratio	UNR1211/1212/1213/121L	R_1/R_2		0.8	1.0	1.2	—
	UNR1214			0.17	0.21	0.25	
	UNR1218/1219			0.08	0.1	0.12	
	UNR121D				4.7		
	UNR121E				2.14		
	UNR121F				0.47		
	UNR121K				2.13		

Note) 1. Measuring methods are based on JAPANESE INDUSTRIAL STANDARD JIS C 7030 measuring methods for transistors.

2. *: Rank classification (UNR1110/1115/1116/1117)

Rank	Q	R	S
h_{FE}	160 to 260	210 to 340	290 to 460

Common characteristics chart

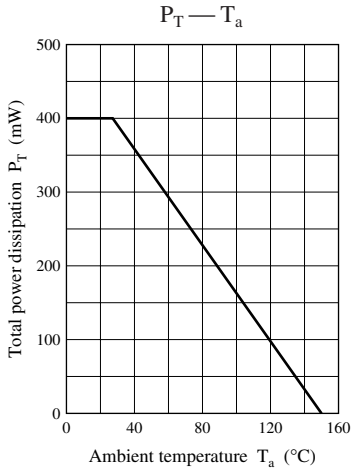

Characteristics charts of UNR1210

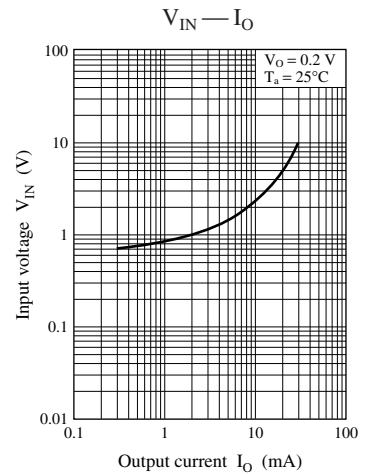
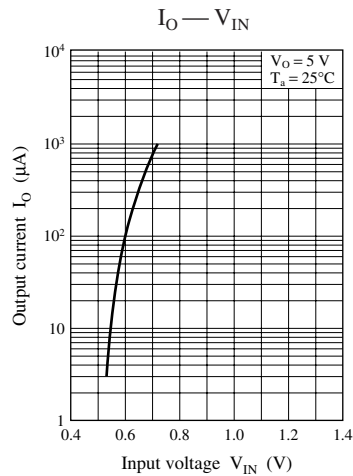
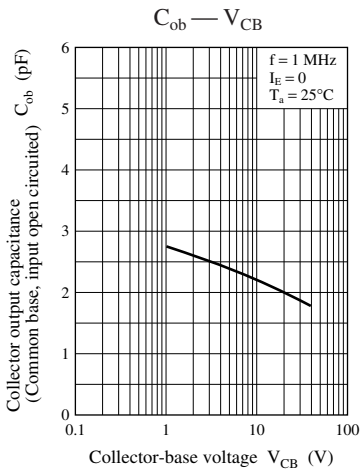
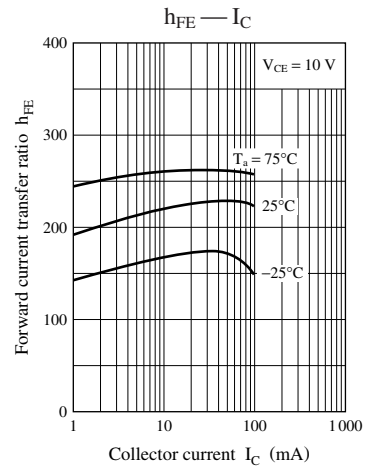
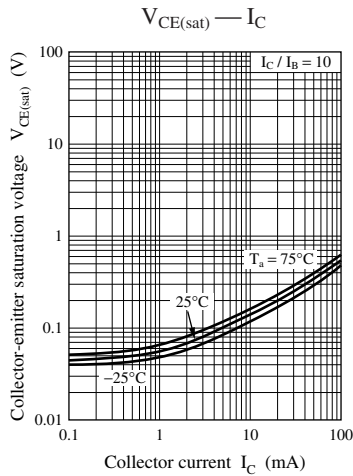
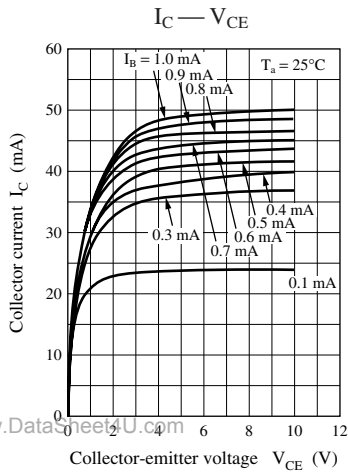

Characteristics charts of UNR1211

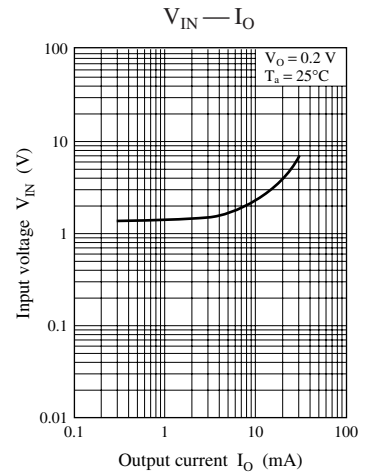
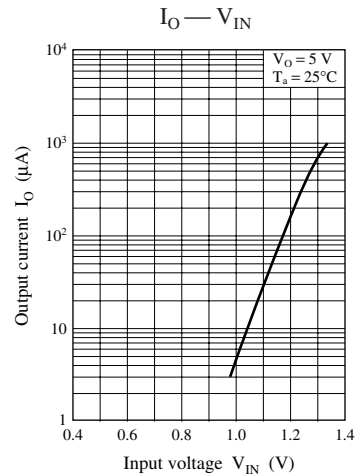
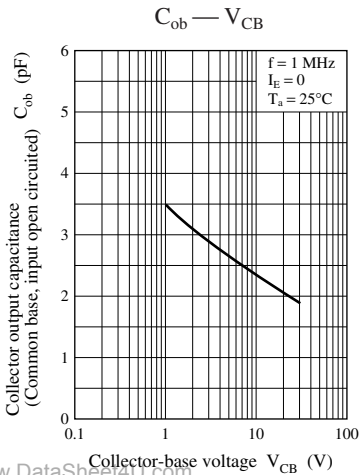
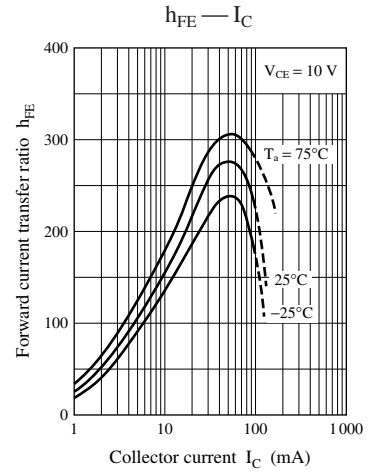
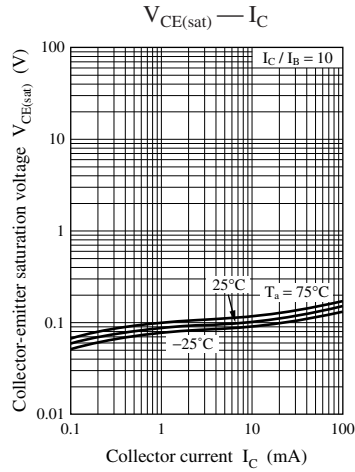
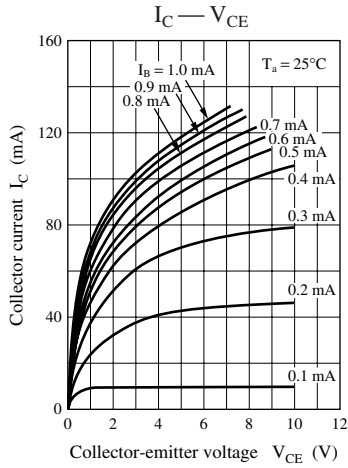

Characteristics charts of UNR1212

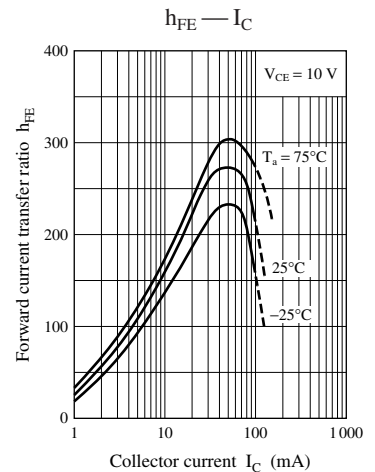
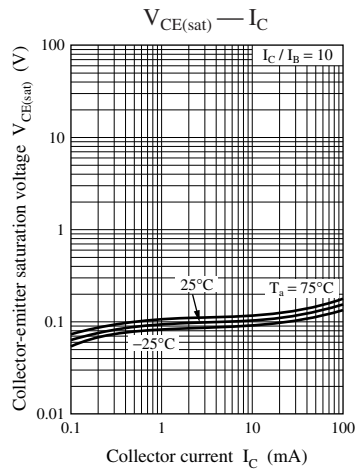
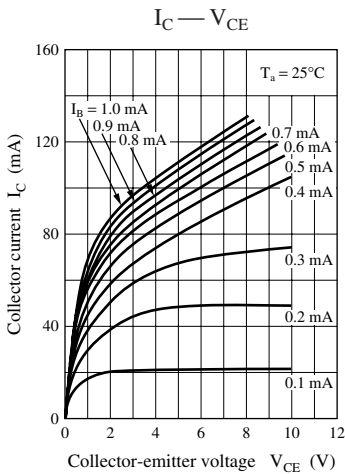

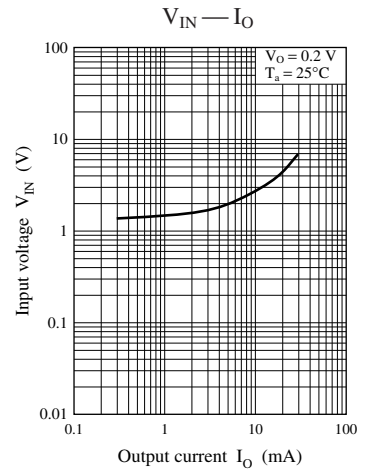
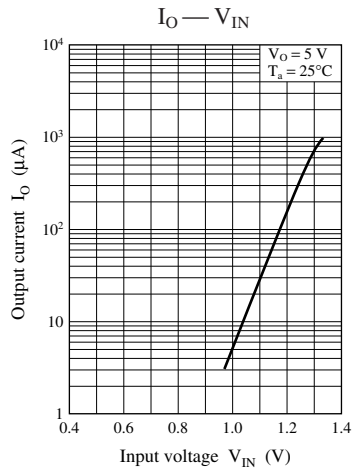
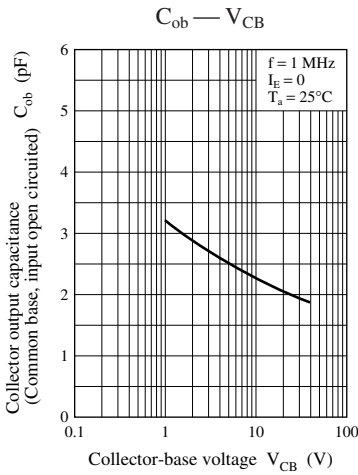

Characteristics charts of UNR1213

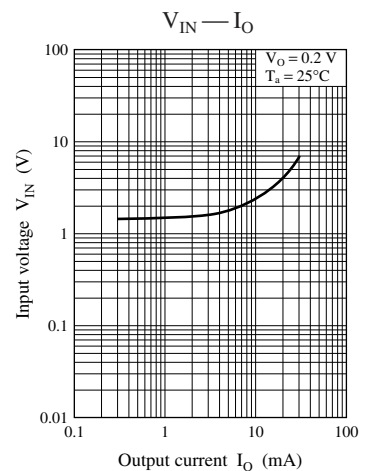
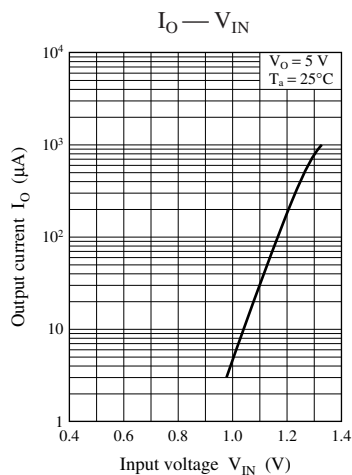
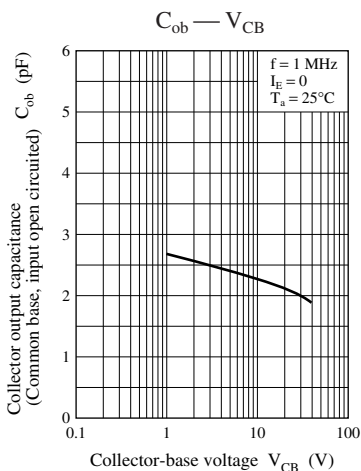
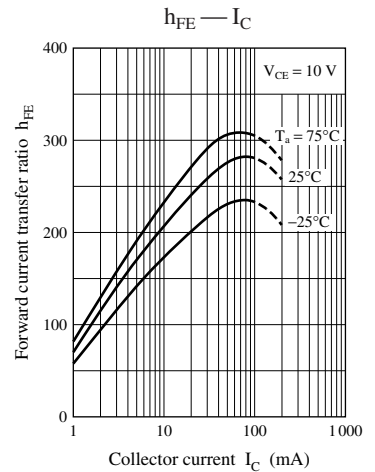
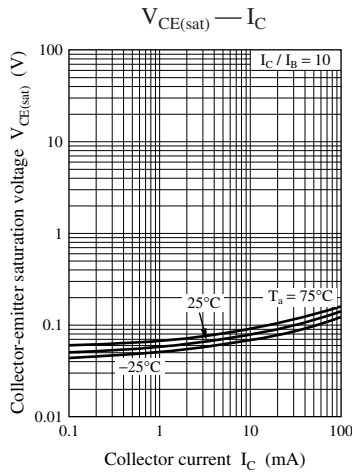
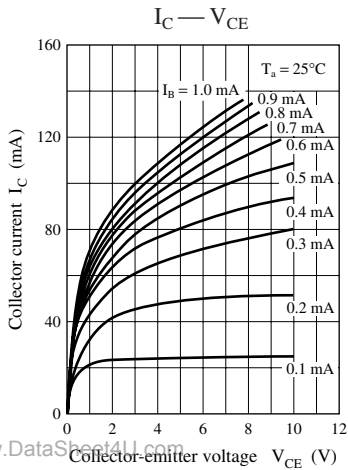

Characteristics charts of UNR1214

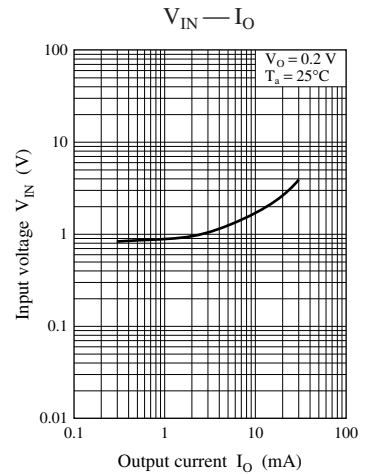
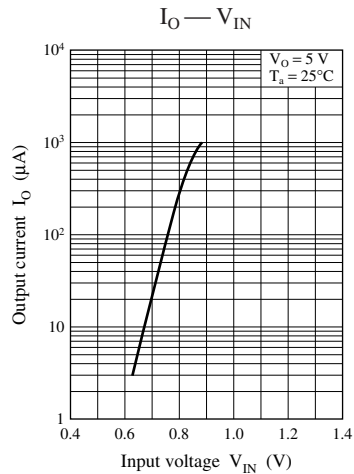
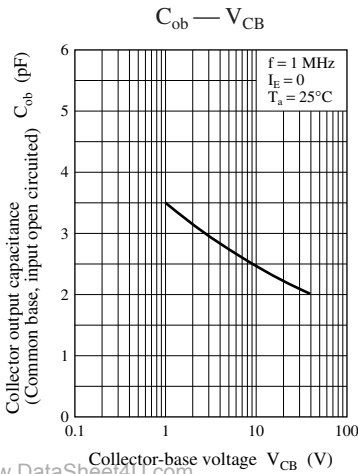
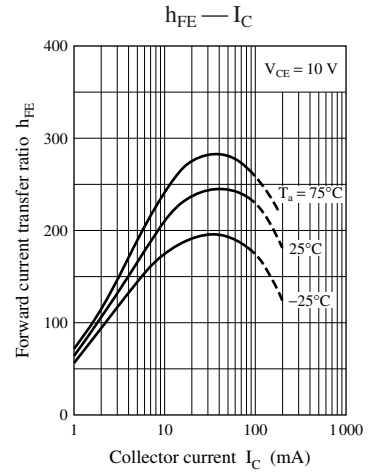
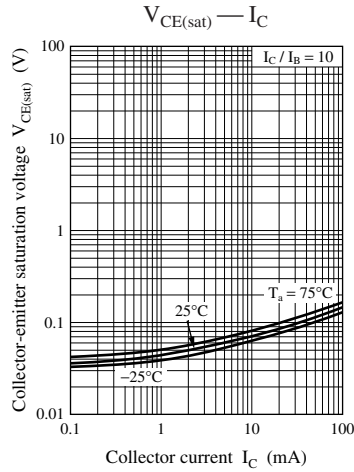
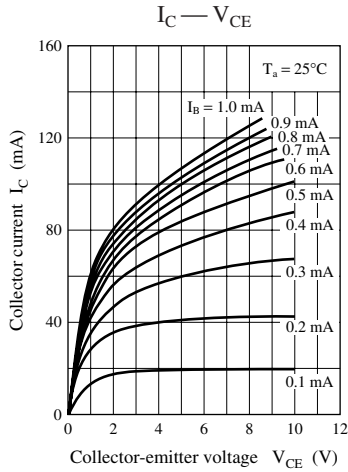

Characteristics charts of UNR1215

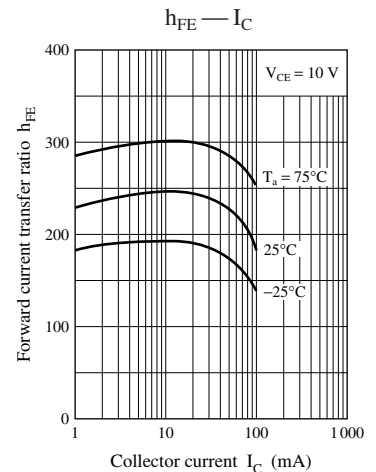
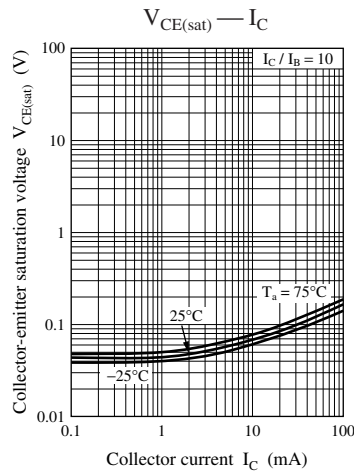
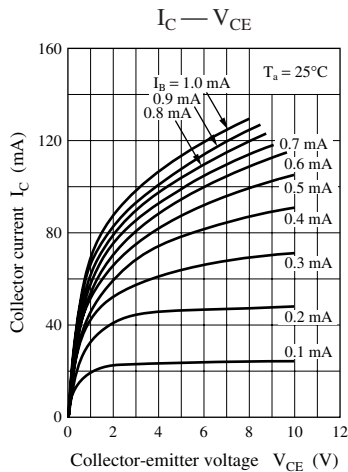

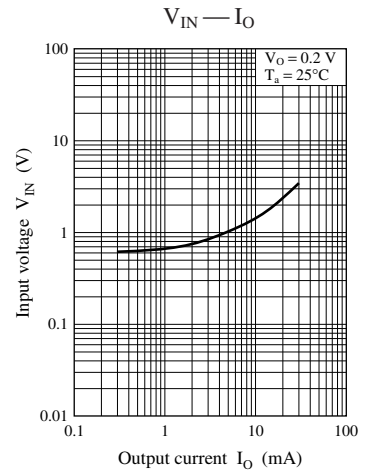
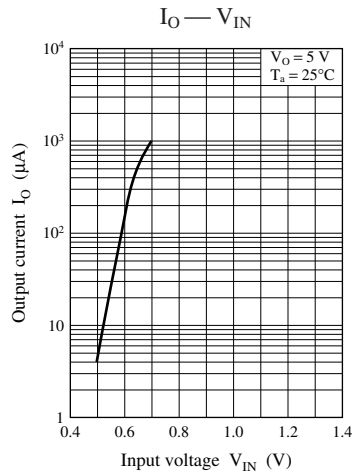
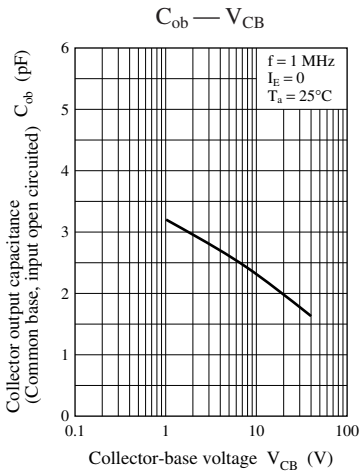

Characteristics charts of UNR1216

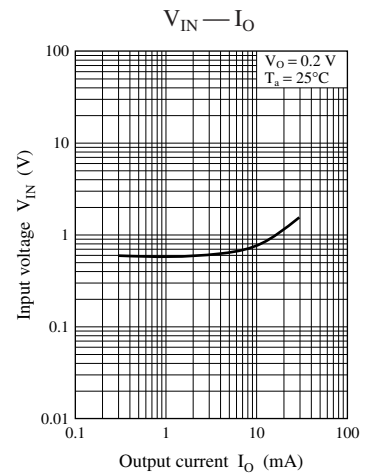
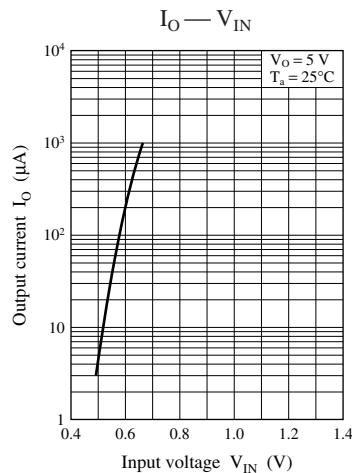
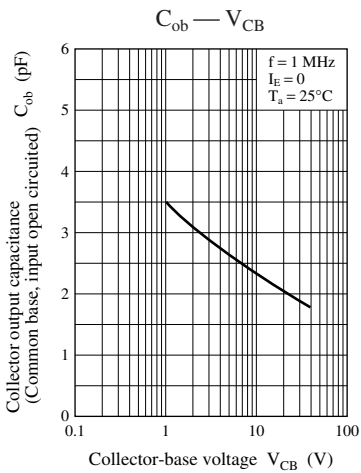
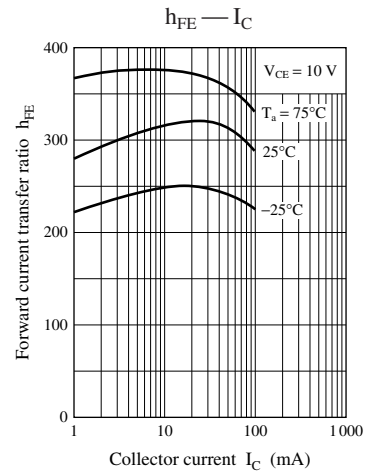
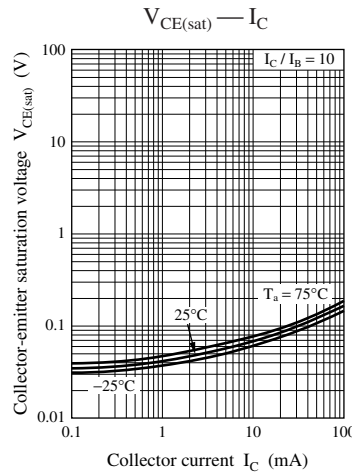
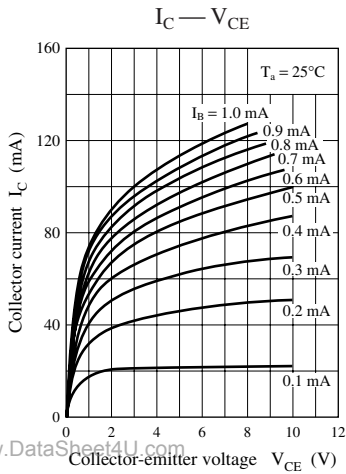

Characteristics charts of UNR1217

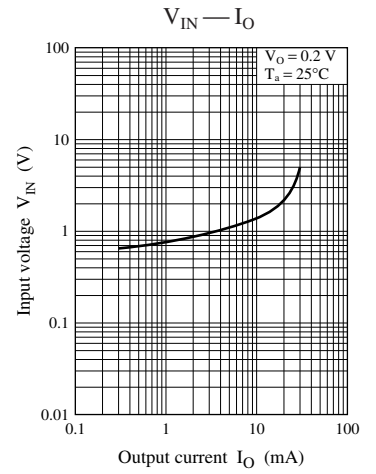
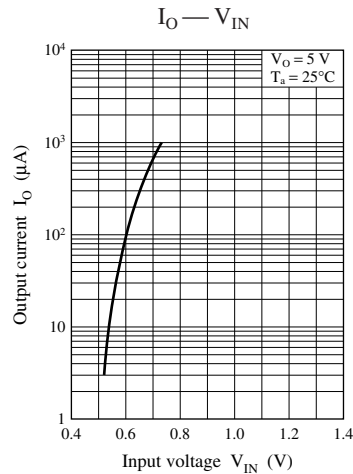
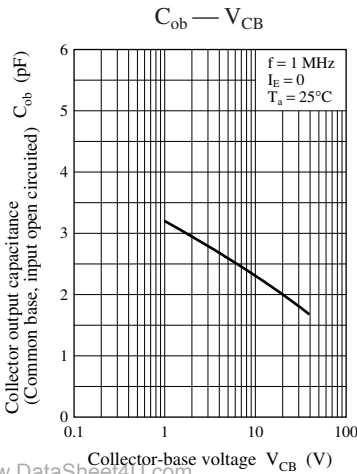
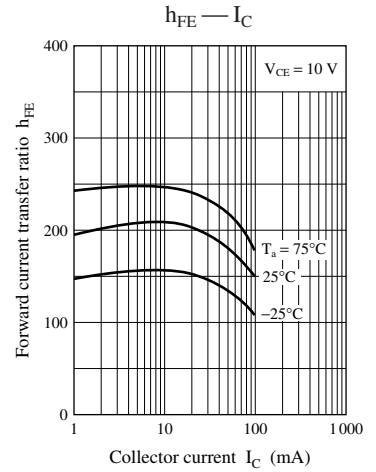
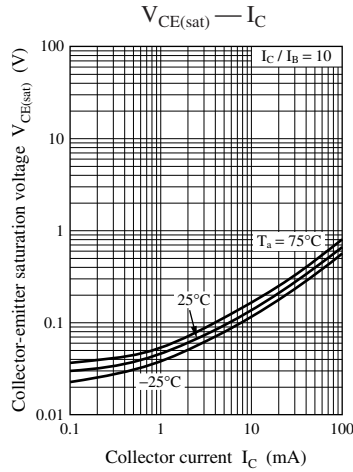
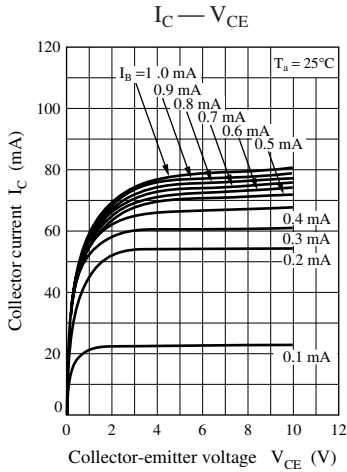

Characteristics charts of UNR1218

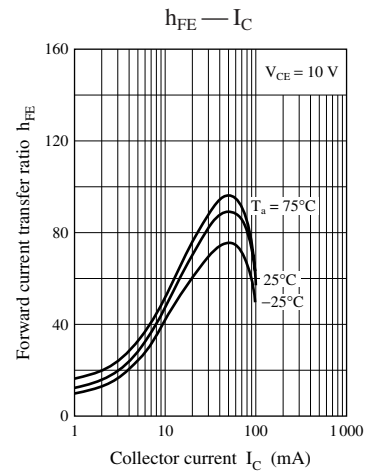
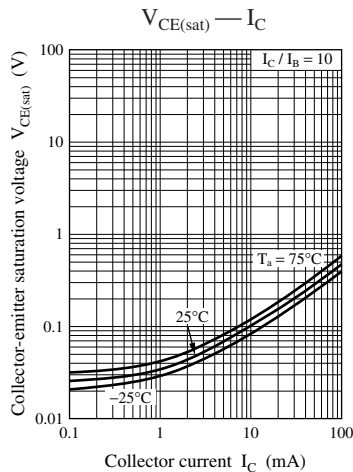
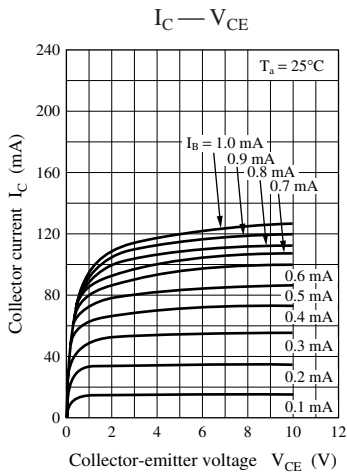

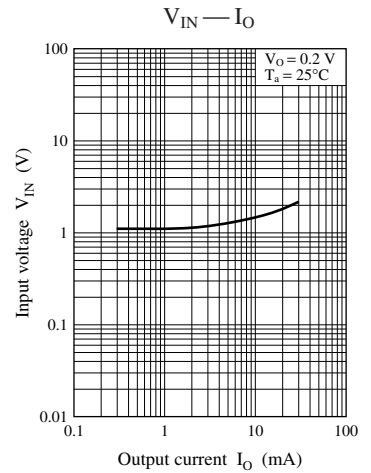
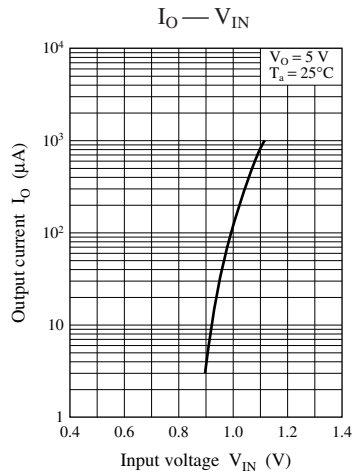
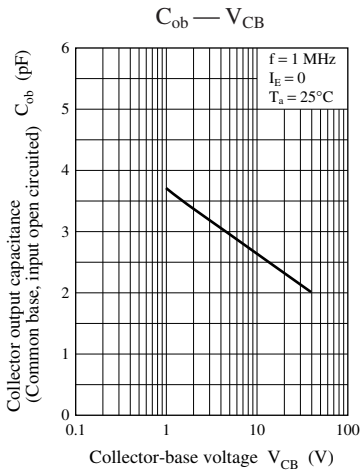

Characteristics charts of UNR1219

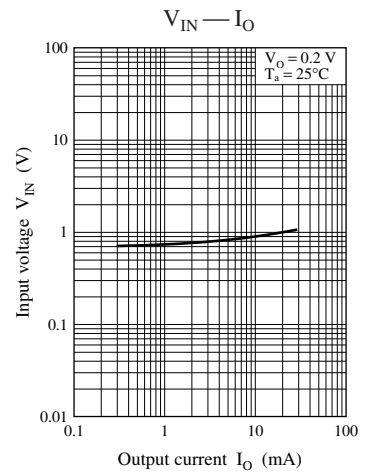
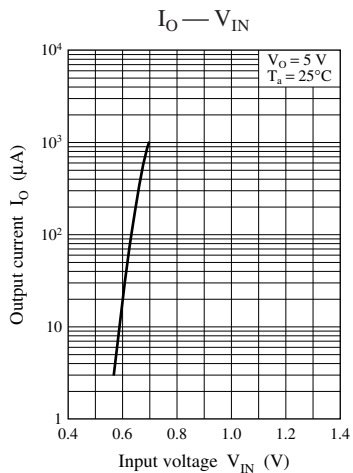
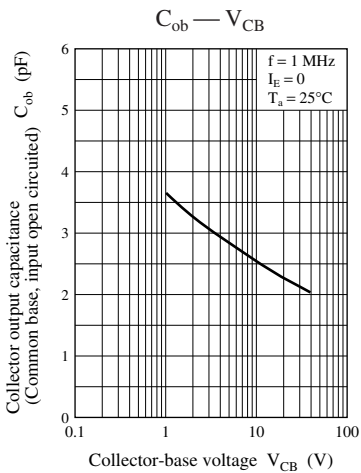
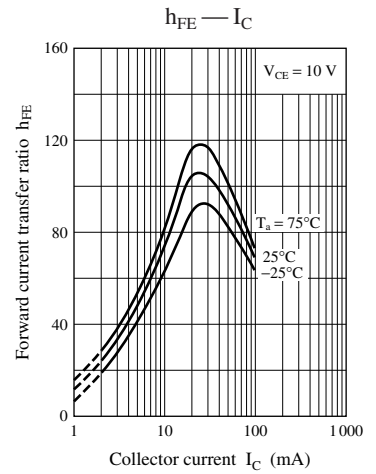
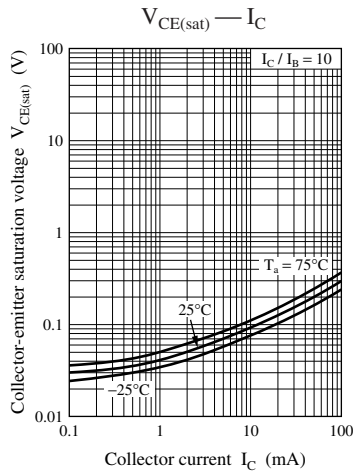
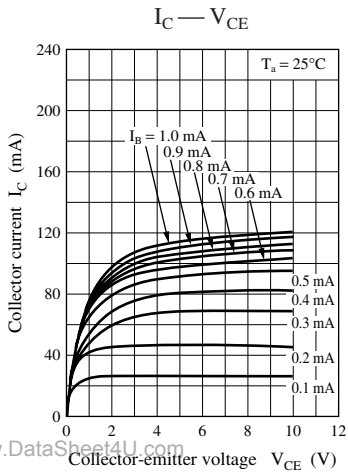

Characteristics charts of UNR121D

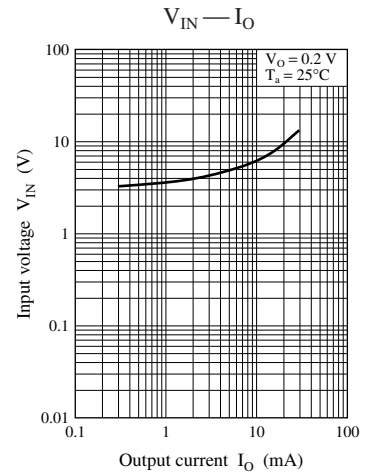
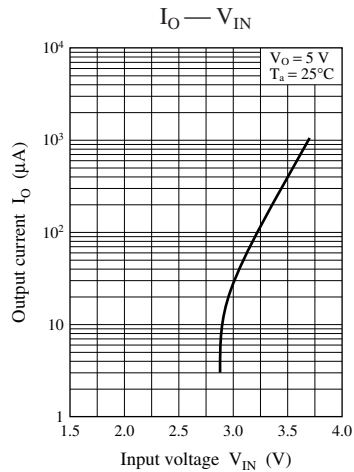
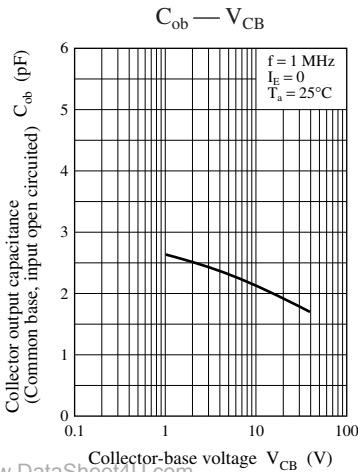
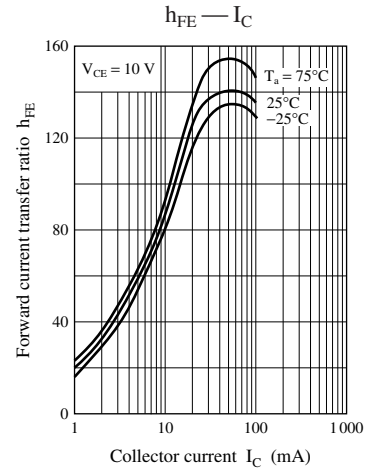
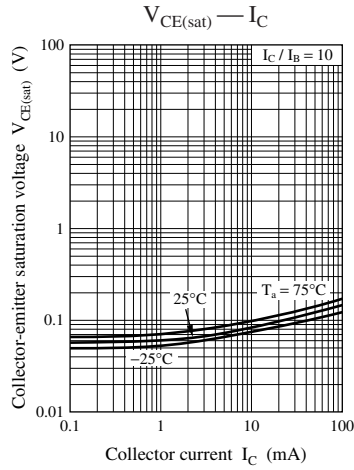
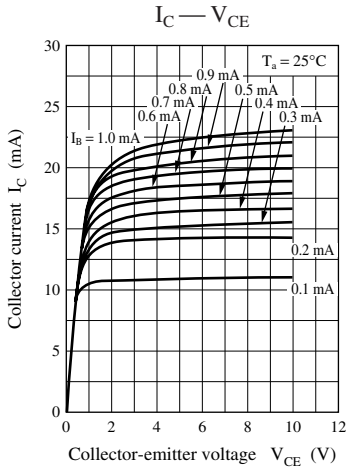

www.DataSheet4U.com

Characteristics charts of UNR121E

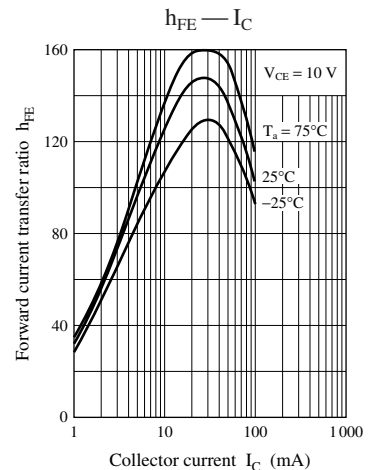
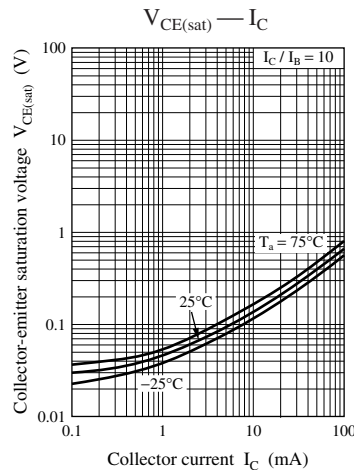
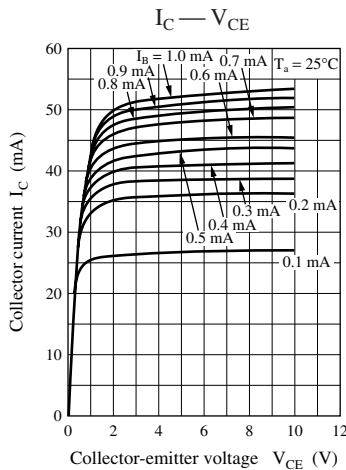

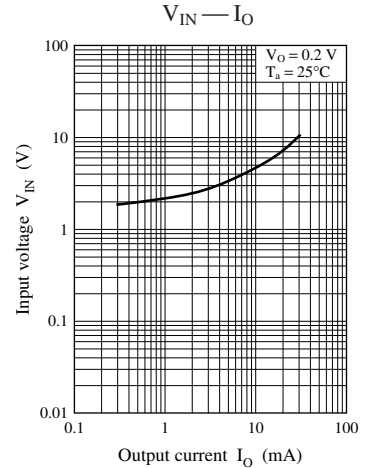
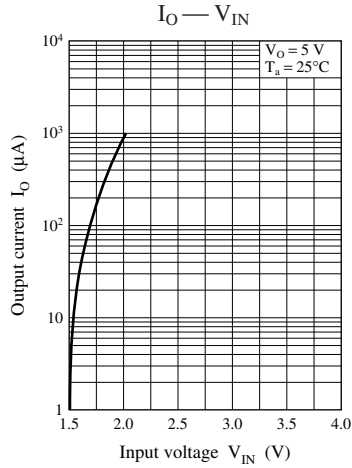
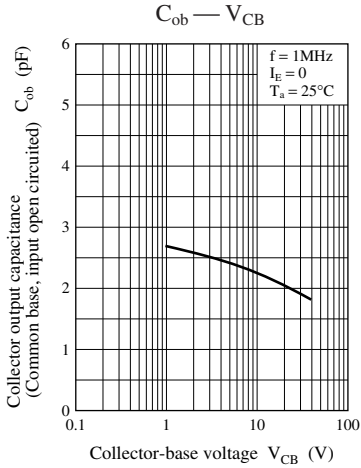

Characteristics charts of UNR121F

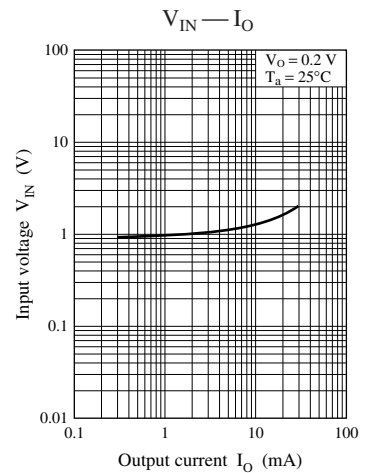
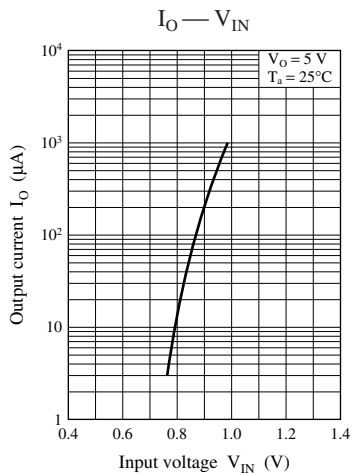
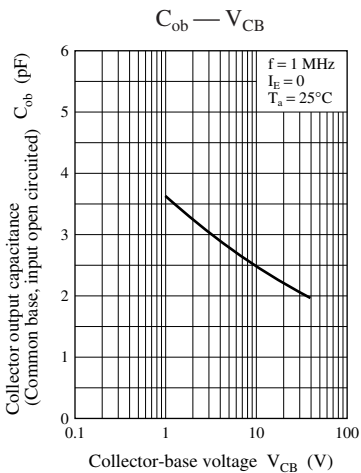
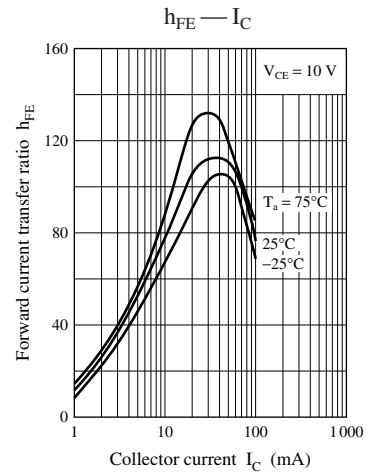
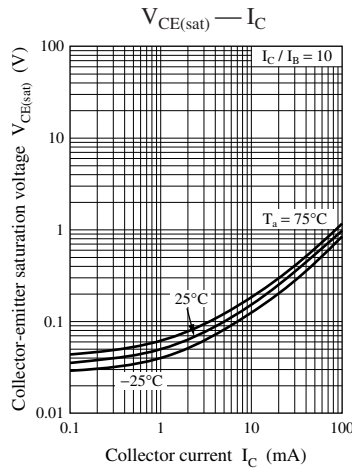
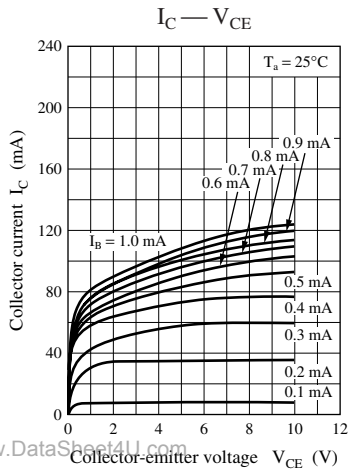

Characteristics charts of UNR121K

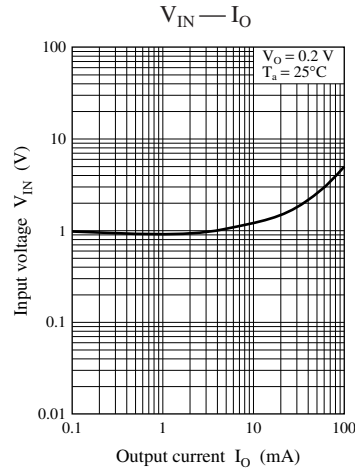
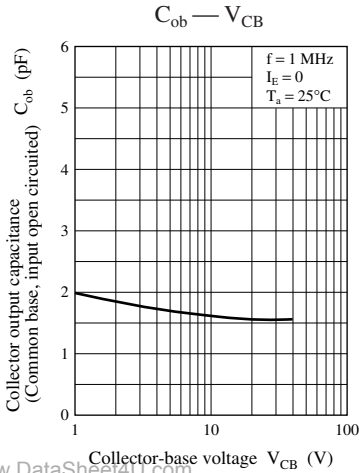
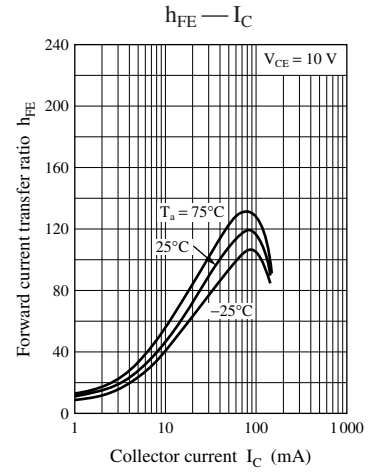
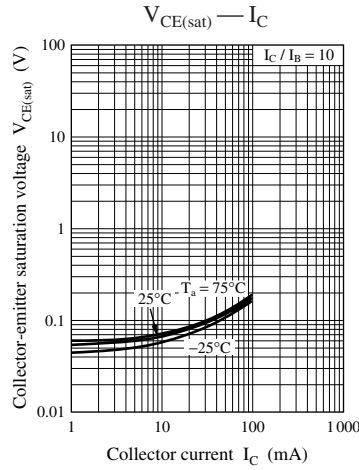
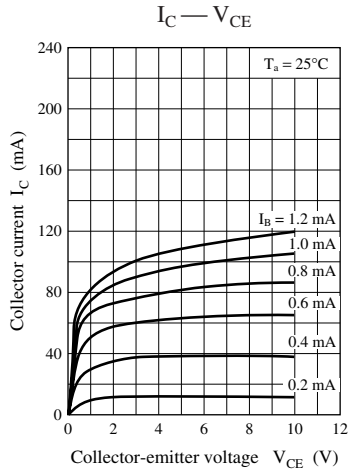

www.DataSheet4U.com

Characteristics charts of UNR121L

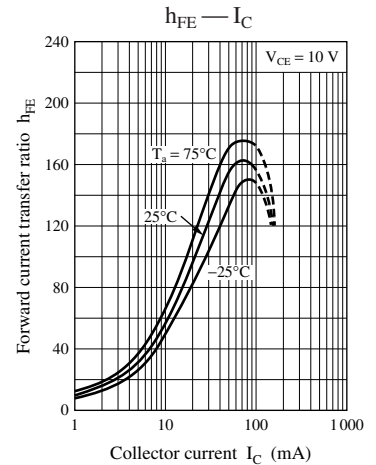
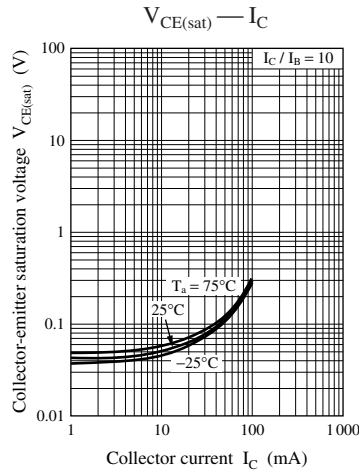
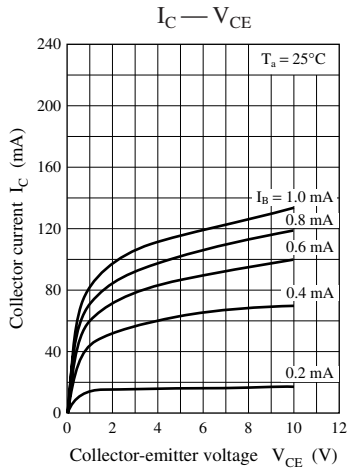

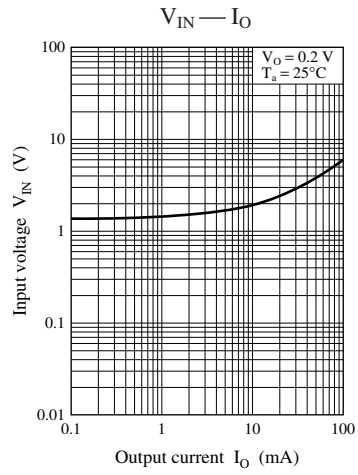
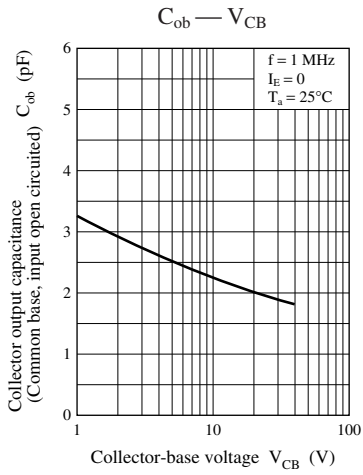

Request for your special attention and precautions in using the technical information and semiconductors described in this material

- (1) An export permit needs to be obtained from the competent authorities of the Japanese Government if any of the products or technical information described in this material and controlled under the "Foreign Exchange and Foreign Trade Law" is to be exported or taken out of Japan.
- (2) The technical information described in this material is limited to showing representative characteristics and applied circuits examples of the products. It neither warrants non-infringement of intellectual property right or any other rights owned by our company or a third party, nor grants any license.
- (3) We are not liable for the infringement of rights owned by a third party arising out of the use of the technical information as described in this material.
- (4) The products described in this material are intended to be used for standard applications or general electronic equipment (such as office equipment, communications equipment, measuring instruments and household appliances).
Consult our sales staff in advance for information on the following applications:
 - Special applications (such as for airplanes, aerospace, automobiles, traffic control equipment, combustion equipment, life support systems and safety devices) in which exceptional quality and reliability are required, or if the failure or malfunction of the products may directly jeopardize life or harm the human body.
 - Any applications other than the standard applications intended.
- (5) The products and product specifications described in this material are subject to change without notice for modification and/or improvement. At the final stage of your design, purchasing, or use of the products, therefore, ask for the most up-to-date Product Standards in advance to make sure that the latest specifications satisfy your requirements.
- (6) When designing your equipment, comply with the guaranteed values, in particular those of maximum rating, the range of operating power supply voltage, and heat radiation characteristics. Otherwise, we will not be liable for any defect which may arise later in your equipment.
Even when the products are used within the guaranteed values, take into the consideration of incidence of break down and failure mode, possible to occur to semiconductor products. Measures on the systems such as redundant design, arresting the spread of fire or preventing glitch are recommended in order to prevent physical injury, fire, social damages, for example, by using the products.
- (7) When using products for which damp-proof packing is required, observe the conditions (including shelf life and amount of time let standing of unsealed items) agreed upon when specification sheets are individually exchanged.
- (8) This material may be not reprinted or reproduced whether wholly or partially, without the prior written permission of Matsushita Electric Industrial Co., Ltd.