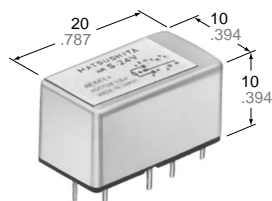

NAIS**LONG LIFE RELAY****NR-RELAYS**

mm inch

FEATURES

- Sealed construction for automatic wave soldering and cleaning
- Latching types available
- High sensitivity — TTL direct drive possible
- High speed — Up to 500 cycle/sec. operations
- Wide switching range and high welding resistance
Gold cobalt (AuCo) contact permits
- Wider switching range from low level up to high current: 10 μ A to 1 A
- Higher sticking resistance to inrush current
- Stable contact resistance from initial stage throughout life

SPECIFICATIONS**Contact**

| | | | |
|--|--------------------------|-----------------------------------|---|
| Arrangement | 1 Form C | | |
| Initial contact resistance, max. (By voltage drop 6 V DC 1 A) | 60 m Ω | | |
| Initial contact pressure | Approx. 5 g .18 oz | | |
| Contact material | Gold cobalt | | |
| Electrostatic capacitance | Contact-Contact | Sealed type | 3 pF |
| | | Magnetically sealed type | 4 pF |
| | N.O. contact-coil | Sealed type | 4 pF |
| | | Magnetically sealed type | 5 pF |
| | N.C. contact-coil | Sealed type | 5 pF |
| | | Magnetically sealed type | 6 pF |
| Nominal switching capacity | | 1A 20 VDC, 0.3A 110 VAC | |
| Rating (resistive) | Max. switching power | | 33 VA, 20 W |
| | Max. switching voltage | | 110 V AC, 30 V DC |
| | Max. switching current | | AC 0.3 A, DC 1 A |
| | Min. switching power | | Approx. 100 mV 10 μ A |
| Expected life (min. operations) | Mechanical (at 500 cps.) | | 10 ⁹ |
| | Electrical (resistive) | 1 A 20 V DC/ 0.3 A 110 V AC | 10 ⁶ (at 1 cps.) |
| | | 0.5 A 30 V DC/ 0.1 A 110 V AC | 3 \times 10 ⁶ (at 2 cps.) |
| | | 0.25 A 30 V DC/ 0.25 A 30 V AC | 5 \times 10 ⁶ (at 5 cps.) |
| | | 0.2 A 24 V DC/ 0.2 A 24 V AC | 10 ⁷ (at 25 cps.) |
| | | 0.1 A 12 V DC/ 0.1 A 12 V AC | 5 \times 10 ⁷ (at 50 cps.) |
| | | 0.1 A 9 V DC/ 0.1 A 9 V AC | 10 ⁸ (at 100 cps.) |

Coil (polarized) (at 25°C 77°F)

| | | |
|-------------------------|--------------------|---------------|
| Minimum operating power | Single side stable | 72 to 133 mW |
| | 1 coil latching | 41 to 45 mW |
| | 2 coil latching | 72 to 107 mW |
| Nominal operating power | Single side stable | 147 to 300 mW |
| | 1 coil latching | 74 to 153 mW |
| | 2 coil latching | 147 to 331 mW |

Characteristics (at 25°C 77°F)

| | | |
|--|-------------------------------|---|
| Max. operating speed | | 500 cps. (mechanical) |
| Initial insulation resistance*1 | | Min. 1000 M Ω at 500 V DC*2 |
| Initial breakdown voltage*3 | Between live parts and ground | 1,000 Vrms |
| | Between open contact | 350 Vrms (500 V DC) |
| | Between contact and coil | 1,000 Vrms |
| Operate time*4 (at nominal voltage) | | Max. 3 ms (Approx. 1 ms) |
| Release time (without diode)*4 (at nominal voltage) | | Max. 2 ms (Approx. 0.5 ms) |
| Contact bounce time | Single side stable | Approx. 0.5 ms |
| | 1-coil /2-coil latching | Approx. 0.3 ms |
| Temperature rise | | Max. 35°C at 0.5 W operating power Max. 65°C at 1 W operating power |
| Shock resistance | Functional*5 | Min. 980 m/s ² {100 G} |
| | Destructive*6 | Min. 980 m/s ² {100 G} |
| Vibration resistance | Functional*7 | 98 m/s ² {10 G}, 10 to 55 Hz at double amplitude of 1.6 mm*8 |
| | Destructive | 117.6 m/s ² {12 G}, 10 to 55 Hz at double amplitude of 2 mm |
| Conditions for operation, transport and storage*9 (Not freezing and condensing at low temperature) | Ambient temp. | -55°C to +65°C*10 -67°F to +149°F |
| | Humidity | 5 to 85% R.H. |
| Unit weight | | Approx. 7 g .25 oz |

Remarks

- * Specifications will vary with foreign standards certification ratings.
*1 Measurement at same location as "Initial breakdown voltage" section
*2 Min. 500M Ω at 100 V DC between coils of 2 coil latching type
*3 Detection current: 10mA, Except for between coils of 2 coil latching type
*4 Excluding contact bounce time
*5 Half-wave pulse of sine wave: 6ms; detection time: 10 μ s
*6 Half-wave pulse of sine wave: 6ms
*7 Detection time: 10 μ s
*8 Although NR relays are rated at 10 G/55 cps. vibration resistance, they will withstand up to 60 G/2,000 cps., provided they receive additional support such as anchoring to the PC board with epoxy resin.
*9 Refer to 5. Conditions for operation, transport and storage mentioned in AMBIENT ENVIRONMENT (Page 61)
*10 Total temperature (ambient temperature plus temperature rise in coil) should not exceed 90°C 194°F for single side stable, and 105°C 221°F for latching relays. See Reference Data for determination of coil voltage versus temperature.

TYPICAL APPLICATIONS

Telecommunications equipment, alarm devices, machine tools, NC machines, automatic warehouse control, conveyors, air-conditioners, pressing machines, tex-

tile machinery, elevators, control panels, pin-board programmers, parking meters, industrial robots, detectors, annunciators, optical instruments, business machines,

time recorders, cash registers, copiers, vending machines, medical equipment.

ORDERING INFORMATION

EX. NR- H L2 D 12V

| Types of case |
|-------------------------------------|
| H: Sealed S: Magnetically sealed |

| Operating function |
|--|
| Nil: Single side stable L: 1 coil latching L2: 2 coil latching |

| Coil voltage (DC) |
|--------------------|
| 5, 6, 12, 24, 42 V |

(Notes) 1. Power types and 1 Form A types are available on request.

2. For UL/CSA recognized types, delete "N" at head portion of part No. and add suffix UL/CSA, when ordering. Ex. RSD-12V UL/CSA

3. Standard packing Carton: 50 pcs., Case: 500 pcs.

TYPES AND COIL DATA (at 25°C 77°F)

Single side stable (NR-SD)

| Nominal coil voltage, V DC | Pick-up voltage, V DC (max.) | Drop-out voltage, V DC (min.) | Maximum allowable voltage, V DC (40°C 104°F) | Coil resistance, Ω (±10%) | Nominal operating power, mW | Inductance, Henrys |
|----------------------------|------------------------------|-------------------------------|--|---------------------------|-----------------------------|--------------------|
| 5 | 3.5 | 0.5 | 13 | 170 | 147 | 0.050 |
| 6 | 4.7 | 0.6 | 14 | 220 | 164 | 0.075 |
| 12 | 9.3 | 1.2 | 28 | 890 | 162 | 0.3 |
| 24 | 16 | 2.4 | 42 | 2,000 | 288 | 0.66 |
| 42 | 28 | 4.2 | 85 | 8,000 | 221 | 2.7 |

1 coil latching (NR-SLD)

| Nominal coil voltage, V DC | Pick-up voltage, V DC (max.) | Maximum allowable voltage, V DC (40°C 104°F) | Coil resistance, Ω (±10%) | Nominal operating power, mW | Inductance, Henrys |
|----------------------------|------------------------------|--|---------------------------|-----------------------------|--------------------|
| 5 | 3.5 | 18 | 340 | 74 | 0.12 |
| 6 | 4.3 | 20 | 450 | 80 | 0.16 |
| 12 | 8.0 | 30 | 1,500 | 96 | 0.66 |
| 24 | 17 | 75 | 6,000 | 96 | 2.4 |
| 42 | 23 | 110 | 12,000 | 147 | 3.9 |

2 coil latching (NR-SL2D)

| Nominal coil voltage, V DC | Pick-up voltage, V DC (max.) | Maximum allowable voltage, V DC (40°C 104°F) | Coil resistance, Ω (±10%) | | Nominal operating power, mW | Inductance, Henrys |
|----------------------------|------------------------------|--|---------------------------|------------|-----------------------------|--------------------|
| | | | Set coil | Reset coil | | |
| 5 | 3.5 | 13.0 | 170 | 170 | 147 | 0.024 |
| 6 | 4.3 | 14.0 | 225 | 225 | 160 | 0.04 |
| 12 | 8.0 | 26.0 | 650 | 650 | 230 | 0.14 |
| 24 | 17.0 | 50.0 | 2,700 | 2,700 | 213 | 0.35 |
| 42 | 23.0 | 75.0 | 5,500 | 5,500 | 321 | 0.8 |

(Note) Maximum allowable operating power: 1000 mW at 25°C 77°F.

DIMENSIONS

mm inch

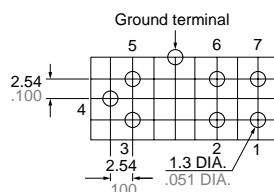
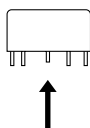
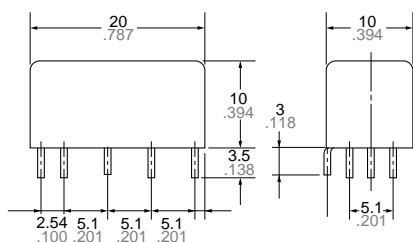

Terminal dimensions (Except soldering)

| Terminal No. | Thickness | Width |
|-----------------------------|-----------------------|-------------|
| 1, 7 | 0.5 .020 | 0.6 .024 |
| 4 | 0.3 .012 | 0.7 .028 |
| 2, 3, 5, 6, ground terminal | 0.5 DIA. .020 DIA. | |

Soldering: 0.3 .012 max.

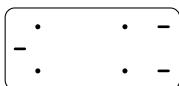

General tolerance: ±0.5 ±.020

Tolerance: ±0.2 ±.008

NR

DIFFERENCES BETWEEN NR RELAYS AND REED RELAYS

| | NR relays | Reed relays |
|---------------------|------------------------------|----------------------|
| Structure | | |
| Contact arrangement | 1 Form C | 1 Form A or 1 Form B |
| Contact capacity | 20 W (high contact pressure) | 5 to 15 W |
| Operating function | Single side stable Latching | Single side stable |
| "Getter" hole | Yes | No |

"Getter" holes are formed on both pole shoes to obtain uniform contact resistance throughout life. Film-forming phenomena on contacts is thus fully prevented.

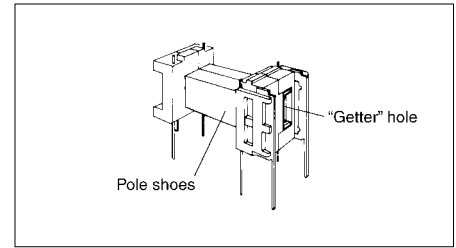

REFERENCE DATA

1.-(1) Contact reliability

Test sample: NR-SD-24V 54 pcs.
Circuits: (A) Following figure with diode
(B) Following figure without diode

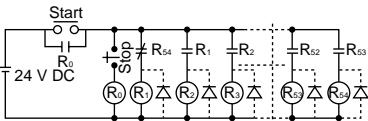

Item to be checked: Detect with the circuit stopped
Circuits:
(A) Diode provided: The circuit does not stop throughout 100 million times.
(B) Diode not provided: $\lambda_{6.0} = 2.5 \times 10^{-8}$ times

1.-(2) Contact reliability TEST CONDITION

Sample: NR-SD-24V, 10 pcs.
Contact voltage: 100 mV
Contact current: 10 μ A
Cycle rate: 50 cps.
Detection level: 100 Ω
Testing operation: 3×10^7
 $m = 1.9$
 $\sigma = 2.5 \times 10^7$
 $\mu = 4.7 \times 10^7$
95% reliability limit: 1.15×10^7
(Mean time between failure)

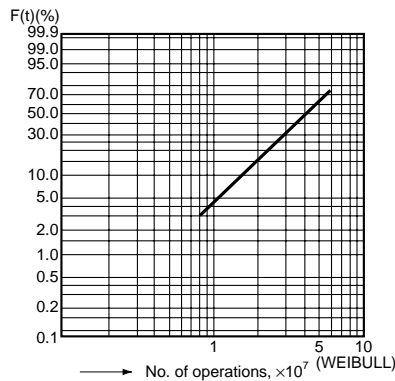

2. Coil temperature rise (under saturated condition)

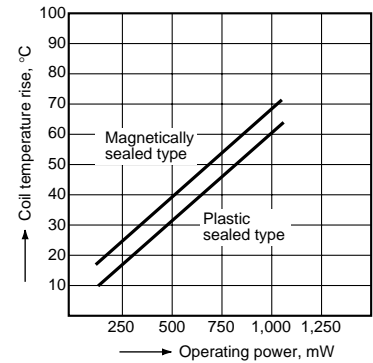

3.-(1) Operate time including bounce time (Single side stable)

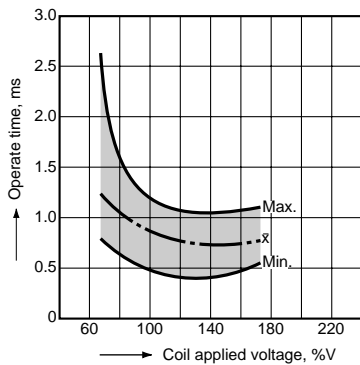

3.-(2) Operate time including bounce time (2 coil latching)

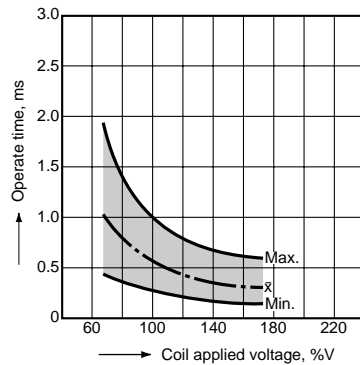

4. Release time including bounce time (Single side stable)

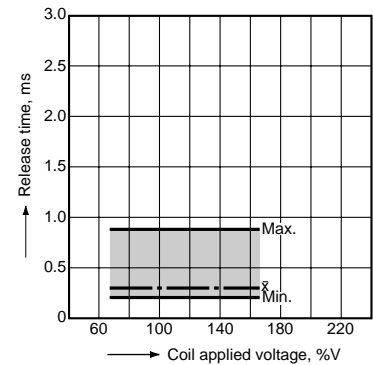

5.-(1) Leaving at high temperature
(Change of pick-up and drop-out voltages)
Tested sample: NR-SD-24V, 30 pcs.
Condition: Deenergized leaving at 90°C 194°F
(constant temperature)

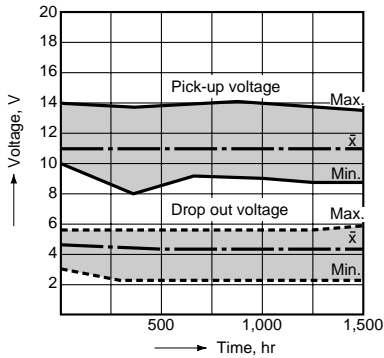

5.-(2) Leaving at high temperature
(Change of contact resistance)
Tested sample: NR-SD-24V, 30 pcs.
Condition: Deenergized leaving at 90°C 194°F
(constant temperature)

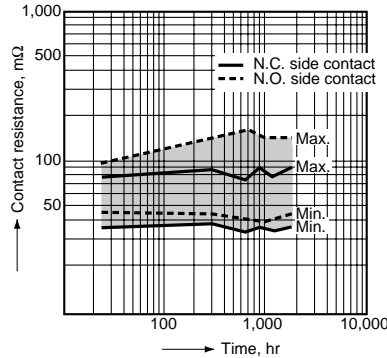

6. High frequency characteristics
Tested sample: NR-SD-24V
Tested condition:

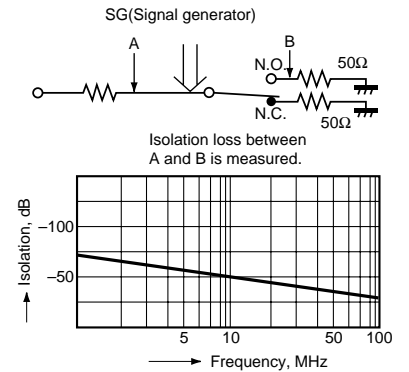

7. Contact sticking resistance
TEST CONDITION

The purpose of this test was to confirm contact sticking resistance and contact stability against coil ripples.
Tested Sample: NR-SD-24V, 10 pcs.
Test method: Following coil ripples were applied.
Test period: 500 hours

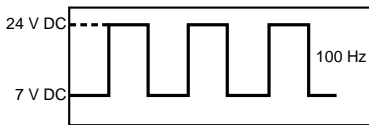

TEST RESULT

No occurrence of sticking was observed.
Contact resistance: Fig. 1
NR-SD-24V: 29 mΩ to 30.4 mΩ

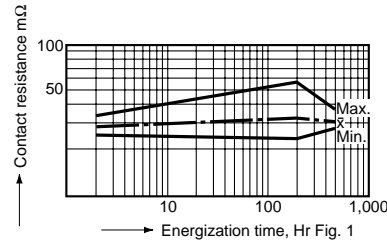

In actual application, above coil ripples should be avoided and use of a capacitor in the circuit is recommended to keep the ripple factor below 5%.

8. Distribution of contact resistance

Tested sample: NR-SD-24V (WG type) 105 pcs.

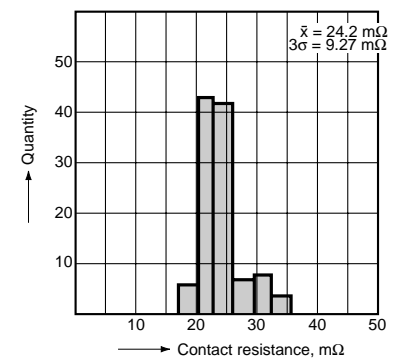

9.-(1) Rate of change in pick-up and drop-out voltage (Single side stable)

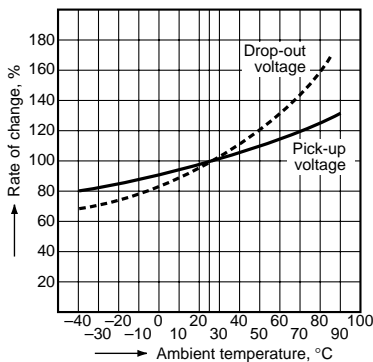

9.-(2) Rate of change in pick-up voltage (2 coil latching)

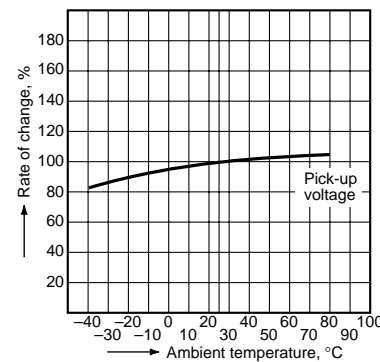

10.-(1) Mechanical life
(Change of pick-up and drop-out V)

Tested Sample: NR-SD-24V, 10 pcs.
Operation frequency: 500 cps

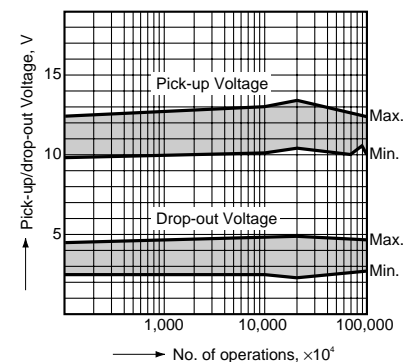

10.-(2) Mechanical life
(Change of contact resistance)
Tested Sample: NR-SD-24V, 10 pcs.
Operation frequency: 500 cps

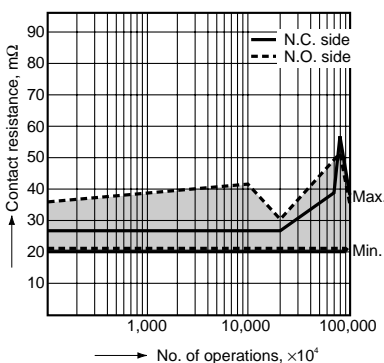

11.-(1) Electrical life
(1 A 20 V DC resistive load)
Tested sample: NR-SD-24V, 10 pcs.

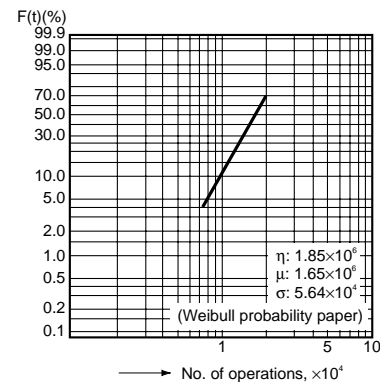

11.-(2) Electrical life
Tested Sample: NR-SD-24V, 10 pcs.
Load: 60 mA 24 V DC resistive load
Frequency: 50 cps

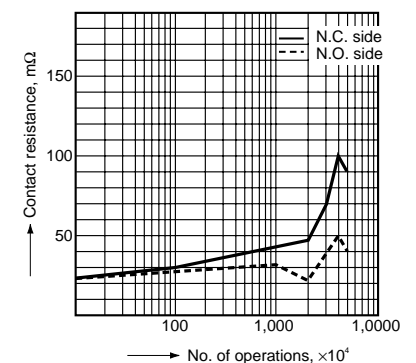

NR

11.-(3) Electrical life

Tested Sample: NR-SD-12V, 10 pcs.
 Load: 54 mA 12 V DC inductive load with diode protection
 (4 relay coils in parallel of NR-SD-12V)
 Frequency: 50 cps

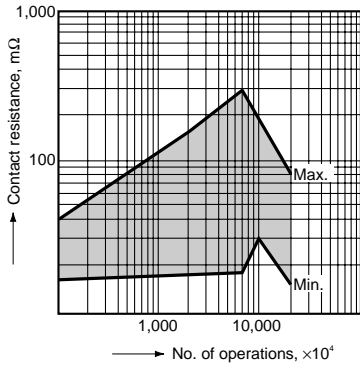

11.-(4) Electrical life

(327 mA 24 V DC relay coil load)
 Tested sample: NR-SD-24V, 5 pcs.
 Condition: HP2-DC24x6 pcs. in parallel, diode protector provided

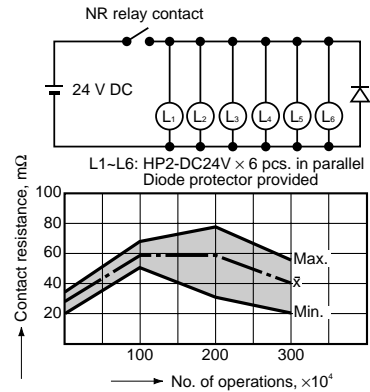
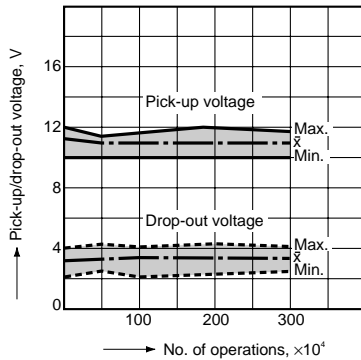

12. Thermal electro motive force

Tested Sample: NR-SD-12V, 5 pcs.
 Coil applied V: 12 V DC
 Ambient atmosphere: 25°C 77°F, 60% RH

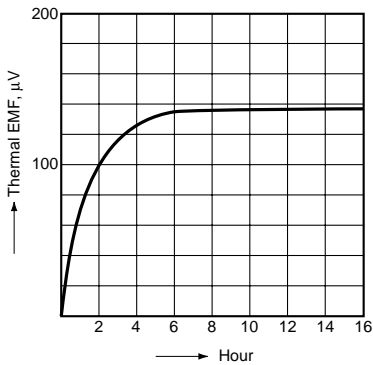

13. High temperature test

TEST CONDITION
 Tested Sample: NR-SD-24V, 30 pcs.
 Ambient temperature: 80°C 176°F
 Humidity: less than 50% R.H.
 Exposure time: 2,000 hours with relays deenergized.

TEST RESULT
 Contact resistance: Fig. 1
 All samples were measured less than 100 mΩ in contact resistance throughout this test.

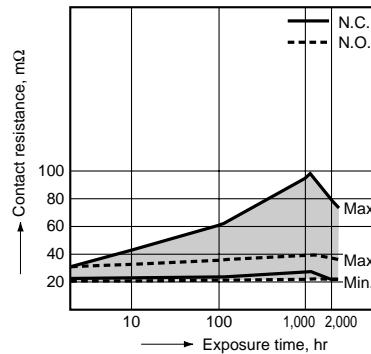

14. Influence of adjacent mounting mm inch

| Type | Distance | | | |
|----------------------------|----------|----------|-----------|-----------|
| | 0 (0) | 5 (.197) | 10 (.394) | 15 (.591) |
| Magnetically shielded type | ±5% | ±1% | 0 | 0 |
| Sealed type | — | ±10% | ±6% | ±2% |

15. Resistive load test

TEST CONDITION
 Tested Sample: NR-SD-24V, 10 pcs.
 Load: 1 A 20 V DC Resistive
 Cycle rate: 1.4 cps.
 Contact resistance in life test

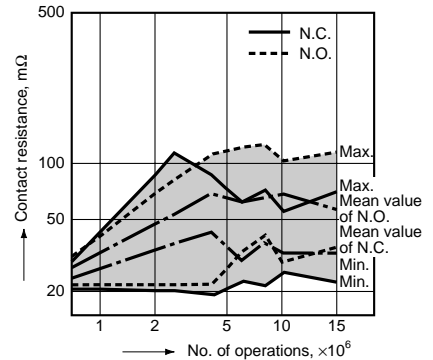

APPLICATION HINTS

Contact protection circuit

When using NR relays in inductive load circuits, a contact protection circuit is recommended.

Examples:

| CR | CR | Diode |
|--|--|------------------------------|
| <p>(L) : Inductive load</p> | | |
| <p>1. r = more than 20 to 30 ohms 2. In an AC circuit impedance of L is to be somewhat smaller than impedance of r and c.</p> | <p>Can be used for both AC and DC circuits. Use 500 to 1000 ohms for r and 0.1 μF to 0.2 μF 200 V for c in a general 12 to 24 V load circuit.</p> | <p>For DC circuits only.</p> |

The following is life data under our HP2 relay load.

| Contact voltage | Contact current | Contact protection circuit | Operating speed | Expected life, min. op. |
|-----------------|-----------------|----------------------------|-----------------|-------------------------|
| 6 V DC | 232 mA | 0.2 μF + 1kΩ or diode | 2 op./s | 3×10 ⁷ |
| 12 V DC | 106 mA | 0.2 μF + 1kΩ or diode | 2 op./s | 3×10 ⁷ |
| 24 V DC | 54 mA | 0.1 μF + 1kΩ or diode | 2 op./s | 3×10 ⁷ |
| 100 V DC | 15 mA | 0.1 μF + 1kΩ or diode | 2 op./s | 2×10 ⁷ |
| 24 V DC | 80 mA | 0.2 μF + 1kΩ | 2 op./s | 3×10 ⁷ |
| 100 V DC | 20 mA | 0.1 μF + 1kΩ or varistor | 2 op./s | 2×10 ⁷ |
| 200 V DC | 10 mA | 0.1 μF + 1kΩ | 2 op./s | 2×10 ⁷ |

(Notes)

- When inrush current occurs in the capacitor load circuit or incandescent lamp load circuit, reduce it to less than 5 A. Electrical life of "AuCo" contact types is 10,000 operations in a 5 A inrush current circuit.
- When 5 A to 10 A inrush current occurs in the capacitor load circuit or incandescent lamp load circuit, the use of power types is recommended.

2 coil latching types

A) The circuit at right is recommended when using one coil for latching and the other coil for reset.

NR relays are sensitive enough to be operated by the discharge of energy accumulated in the inner-coil capacitance. The use of a diode of over 200 V breakdown will prevent misoperation from this source. In order to maintain the insulation between the two coils, connection of the terminal No. 3 and No. 6 or the terminal No. 2 and No. 5 is recommended, as shown in the right figure.

Rectifiers should be inserted in this circuit when the nominal coil voltage of the NR relay is more than 24 V DC.

B) No damage will occur to the coil of either the one or two coil latching types even if the operating voltage is as much as 2 or 3 times the nominal coil voltage.

C) If separate pulses are applied to each coil of the 2 coil latching types, the first pulse will operate when the pulses are of equal voltage. When voltages differ the higher voltage will cause operation provided the voltage difference is greater

than the measured pick-up voltage. Voltage difference on the coils will reduce contact pressure proportionately. Continuous bias voltage after an operating pulse lowers contact pressure and vibration resistance.

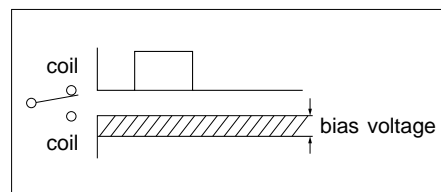

Ripple factor

Coils should be operated on pure DC. Rectified AC may cause changes in the

pick-up/drop-out characteristics because of the ripple factor. Use of a capacitor in

the circuit is recommended to keep the ripple factor below 5%.

To calculate the ripple factor

$$\text{Ripple factor (\%)} = \frac{E_{\text{max.}} - E_{\text{min.}}}{E_{\text{mean}}} \times 100\%$$

E max. = max. value of pulsating component
 E min. = min. value of pulsating component
 E mean = average value DC component

When designing NR relay circuits

Care should be taken when designing relay circuits since the response of the relay is so fast that bouncing or chattering from conventional relays in the circuit may cause false operation.

When using long lead wires

When long wires (as long as 100 m or more) are to be used, the use of resistance (10 to 50 Ω) in series with the contact is required in order to eliminate the effect of the possible inrush current due to the stray capacitance existing between the two wires or between the wire and ground.

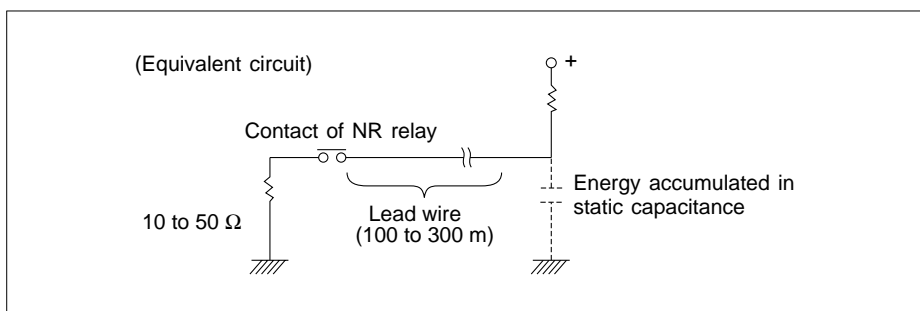

NR

AC operation of latching relays

When using circuits such as those at the right, avoid continued or extended latching or resetting power input.

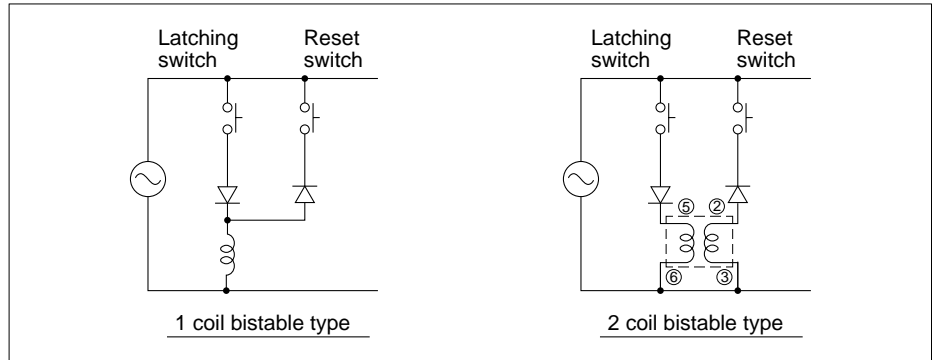

Capacitor discharge operation of latching types

When operating latching types by discharge of a capacitor, more reliable operation can be expected if the time to reach pick-up voltage is greater than 2 ms at 5 to 10 μF : (24 V type).

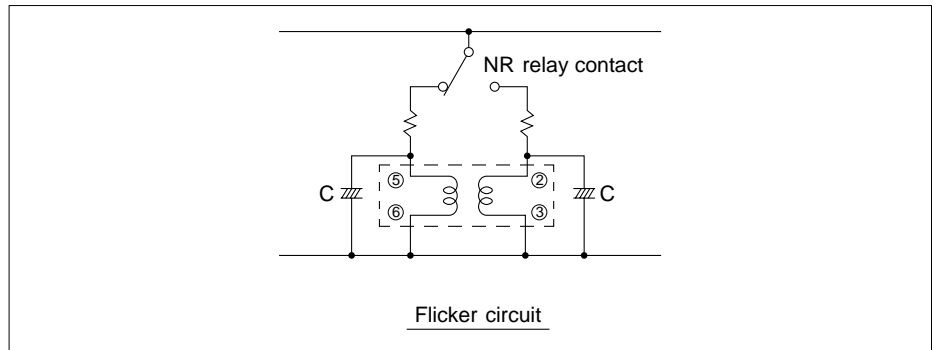
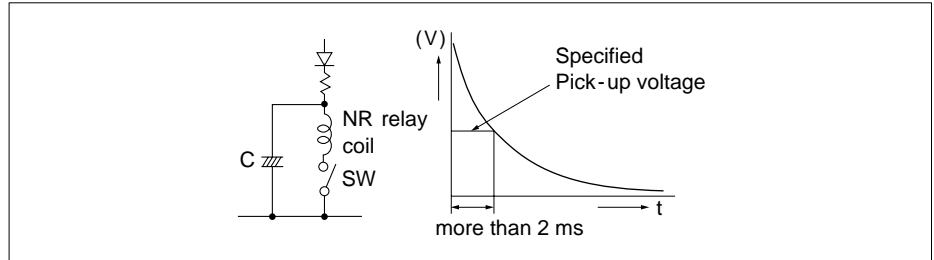

Automatic coil circuit interruption

Misoperation may occur in self-operated cutoff circuits such as shown at right. This can be avoided by adding a resistor and capacitor and increasing the pick-up voltage to above that specified.

In a timer circuit, step-pulse voltage from PUT (Programmable Unijunction Transistor) or SBS (Silicon Bilateral Switch) is recommended.

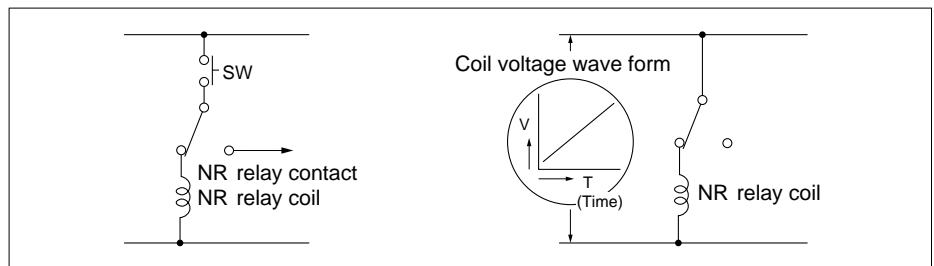

Residual voltage

When single side stable types or latching types are driven by transistor or UJT, residual voltage is sometimes applied to the

coils and decreases contact pressure at N.O. side even if the transistor or UJT are in OFF condition. As a result, characteris-

tics of relays may be harmed. Design your circuits in principle to make such residual voltage zero.

Short circuit prevention between N.C. and N.O.

The separation of loads or insertion of a resistor for circuit protection are recommended for the circuits where large current flows due to arcing. (See Fig. 1).

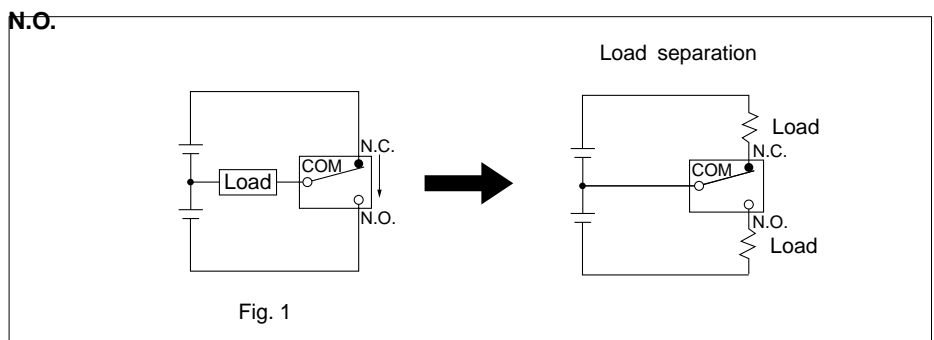

ACCESSORIES

PC board terminal sockets (with hold-down clip)

PC board pattern (Copper-side view)

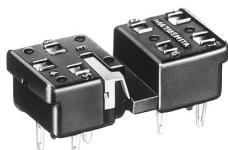

R-PS

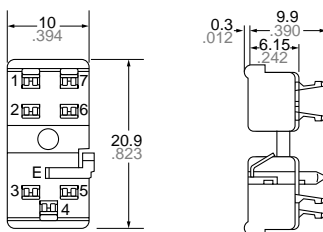

Terminal width: 1.3 .051
Terminal thickness: 1.2 .047

General tolerance: $\pm 0.5 \pm .020$

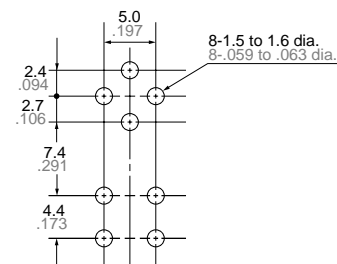

Tolerance: $\pm 0.2 \pm .008$

For Cautions for Use, see Relay Technical Information (Page 48 to 76).