

GENERAL DESCRIPTION

The ML0XX18 is an external modulator driver for 10Gb/s optical communication systems. Output voltage swing, output voltage offset, and output voltage cross-point are adjustable by controls of current inputs. A D-FF and a selector are integrated on the chip to implement selectable re-timing/bypass function. Data and clock inputs have high sensitivity of 200mV differential amplitude. Both DC/AC-coupled connections are allowed for the data inputs. Clock input supports AC-coupled connection. The ML0XX18 is available in a 32-pin Small Lead-frame Package (SLP-type) or in a die form.

FEATURES

- Operation for 10Gbps Optical Communication
- On-chip Input / Output 50Ω Termination
- Built-in D-FF
(Retiming and Non-retiming Mode Selectable)
- Output Voltage Swing:
Vo-pp(Max.)=3 Vp-p min. @RL=50Ω
- The -5.2V Single Power Supply
- DC or AC Coupled Data Input
with High Sensitivity of 200mV Differential (100mV per side).

- Adjustable Output Modulation Voltage:
Vo-pp= 1 – 3Vpp
- Adjustable Output Voltage Offset:
Voh= -1.0 – 0V
- Adjustable Output Voltage Cross-Point:
CP= 30 - 75%

< Keep safety first in your circuit designs! >

Mitsubishi Electric Corporation puts the maximum effort into making semiconductor products better and more reliable, but there is always the possibility that trouble may occur with them. Trouble with semiconductors may lead to personal injury, fire or property damage. Remember to give due consideration to safety when making your circuit designs, with appropriate measures such as (i)placement of Substitutive, auxiliary circuits, (ii)use of non-flammable material or (iii)prevention against any malfunction or mishap.

APPLICATION

- SONET OC-192 and SDH STM-64 Transmission systems
- 10Gb/s Ethernet Modules
- 10Gb/s Fibre Channel Modules

RECOMMENDED OPERATING CONDITIONS

Symbol	Parameter	Test Conditions	Ratings			Unit
			Min.	Typ.	Max.	
V _{EE}	Supply Voltage	—	-5.46	-5.2	-4.94	V
V _{GND0} V _{GNDON}	Driver Output Termination Voltage (GND0/GNDON)	R _L =50Ω	—	0	—	V
V _{DATA}	DATA Input Voltage Amplitude	AC-coupled/side	0.1	0.25	1	V
V _{DATA(High)}	DATA Input Level High	DC-coupled	-0.45	-0.375	-0.0	V
V _{DATA(Low)}	DATA Input Level Low	DC-coupled	-1.0	-0.625	-0.55	V
V _{CLK}	CLK Input Voltage Amplitude	AC-coupled/side	0.1	0.25	1	V
I _M	Output Voltage Modulation Control Current	—	0	—	6.0	mA
I _{OFS}	Output Voltage offset Control Current	Bias	0	—	6.0	mA
		Non-Bias	—	Floating	—	mA
I _{CRSADJ}	Cross-Point Control Current	—	0.25	0.35	0.5	mA
T _C	Operating Case Temperature	—	0	—	85	°C

ABSOLUTE MAXIMUM RATINGS

Symbol	Parameter	Ratings		Unit
		Min.	Max.	
V _{EE}	Supply Voltage	-7.0	0.5	V
	All Pins	V _{EE}	0.5	V
V _{DATA} , V _{CLK}	Input Voltage	-6	0.5	V
V _{OUT}	Output Voltage	-4	2.5	V
I _{OUT}	Output Current	—	100	mA
I _M	Output Voltage Modulation Control Current	—	10	mA
I _{OFS}	Output Voltage offset Control Current	—	10	mA
I _{CRSADJ}	Cross-Point Control Current	—	3	mA
T _J	Junction Temperature	-40	150	°C
T _{STG}	Storage Temperature	-40	150	°C

ELECTRICAL CHARACTERISTICS (Ta = 25±3°C, V_{EE} = -5.2V, f_{DATA} = 10.3Gb/s, PRBS 2³¹-1, R_L = 50Ω)

Symbol	Parameter	Test Conditions	Ratings			Unit	
			Min.	Typ.	Max.		
f _{DATA}	Maximum Data Rate	NRZ	—	10.3	—	Gb/s	
f _{CLK}	Clock Rate		1.0	10.3	—	GHz	
I _{EE}	Power Supply Current	I _{OFS} =floating, I _M =6mA, CP=50%, AC-coupled inputs	Retiming mode	—	310	TBD	mA
			Non retiming mode	—	270	TBD	
V _{O-PP} (Max.)	Output Voltage Swing(Max.)	I _{OFS} =floating, I _M =6mA, CP=50%	—	3.0	—	Vp-p	
V _{O-PP} (Min.)	Output Voltage Swing(Min.)	I _{OFS} =floating, I _M =2mA, CP=50%	—	1.0	—	Vp-p	
V _{OH}	Output High Voltage	I _{OFS} =floating, I _M =6mA, CP=50%	—	0	—	V	
V _{OL}	Output Low Voltage	I _{OFS} =floating, V _{OFS} =0V	—	-3.2	—	V	
V _{OFS}	Output Offset Voltage		-1.0	—	0	V	
CP	Cross-point Control Range		TBD	—	75	%	
t _R	Rise Time	I _{OFS} =floating, I _M =6mA, CP=50%, 20-80%	—	30	—	ps	
t _F	Fall Time	I _{OFS} =floating, I _M =6mA, CP=50%, 20-80%	—	30	—	ps	
JIT _{PP}	Jitter P-P	I _{OFS} =floating, I _M =6mA, CP=50%	Retiming mode	—	12	—	ps
			Non retiming mode	—	12	—	ps
PM	Phase Margin		270	—	—	degrees	
S11 (Data)	Data Input Reflection Coefficient	50MHz to 10GHz	—	-10	—	dB	
S11 (CLK)	Clock Input Reflection Coefficient	1GHz to 10GHz	—	-10	—	dB	
S22	Output Reflection Coefficient	50MHz to 10GHz, D _{OUT} =ON	—	-10	—	dB	

ORDERING INFORMATION

Part Number	Description
ML0CP18	Bare Die
ML01618	32-pin SLP, 5mm x 5mm

FUNCTIONAL DESCRIPTION

The ML0XX18 is an external modulator driver integrating a D-FF and output waveform adjustment controls, such as output swing, offset voltage, and cross point. These functions of the ML0XX18 help customers to realize an excellent optical waveform on their system.

Figure 1 shows the block diagram of the ML0XX18.

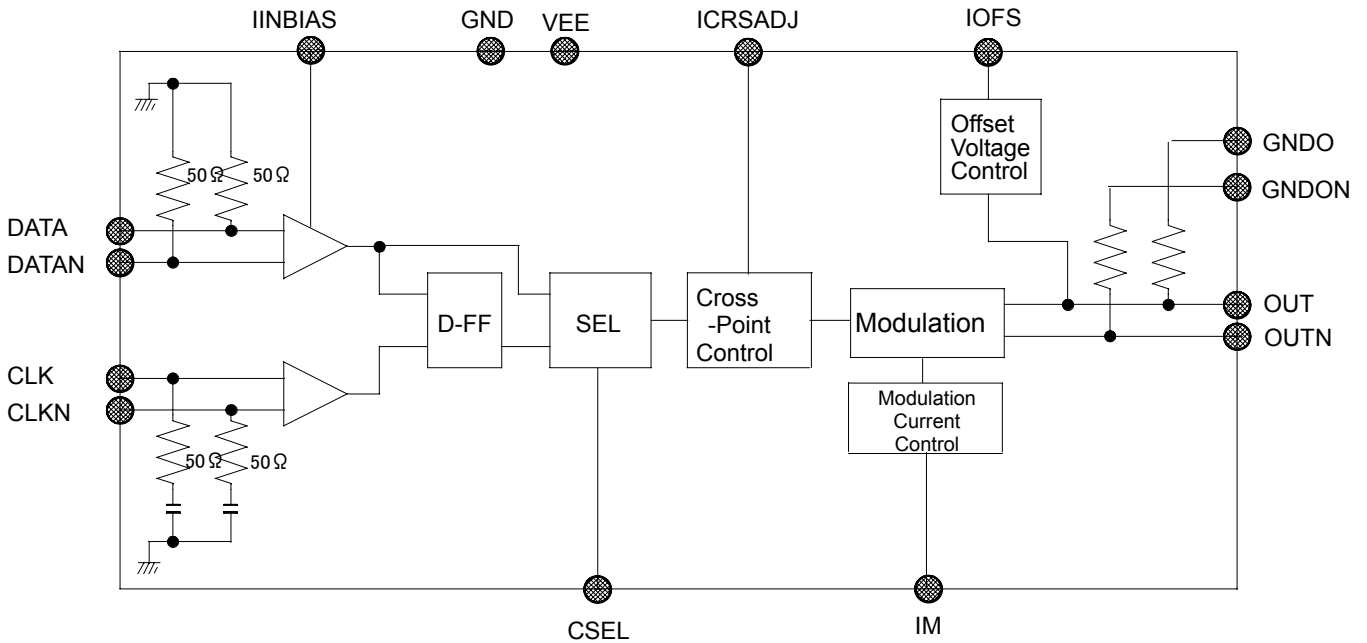

Figure 1. ML0XX18 Block Diagram

DATA/CLOCK INPUT

Both the data and clock inputs have on-chip 50Ω terminations. Thanks to the high gain input buffers, the sensitivities of data and clock inputs are as high as 200mV differential.

For the data input interface, both DC/AC-coupled connections are allowed. In the case of DC couple, keep IINBIAS floating or connect to VEE in order to disable the internal biasing generator. If interfacing by AC couple, connect IINBIAS to GND, and external DC blocking capacitors are required for AC couple.

The clock input supports only AC-coupled configuration. External DC blocking capacitors are needed as well.

DATA OUTPUT

The data output of ML0XX18 has integrated terminations on chip. The positive output OUT and the negative output OUTN have associated GND PAD named GNDO and GNDON, respectively. GNDO and GNDON are disconnected from other GND line on chip, and needed to be connected to GND externally.

Give a special attention to impedance design for OUT and OUTN. The impedances of both output terminals need to be the same regardless of the output to drive an EAM/LD or not. For ML0CP18, design same output bond-wire lengths. This notification is of importance for proper operation of driver IC.

The output waveforms of ML01618 (SLP) are shown in Figure 2, and those of ML0CP18 (Bare Die) are shown in Figure 3.

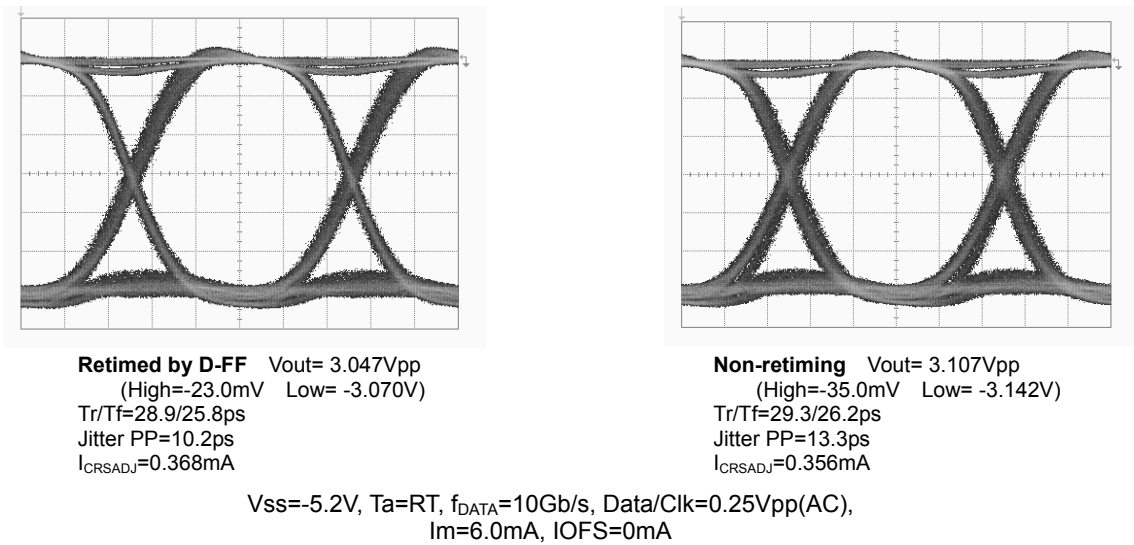

Figure 2. ML01618(SLP) Output Waveforms

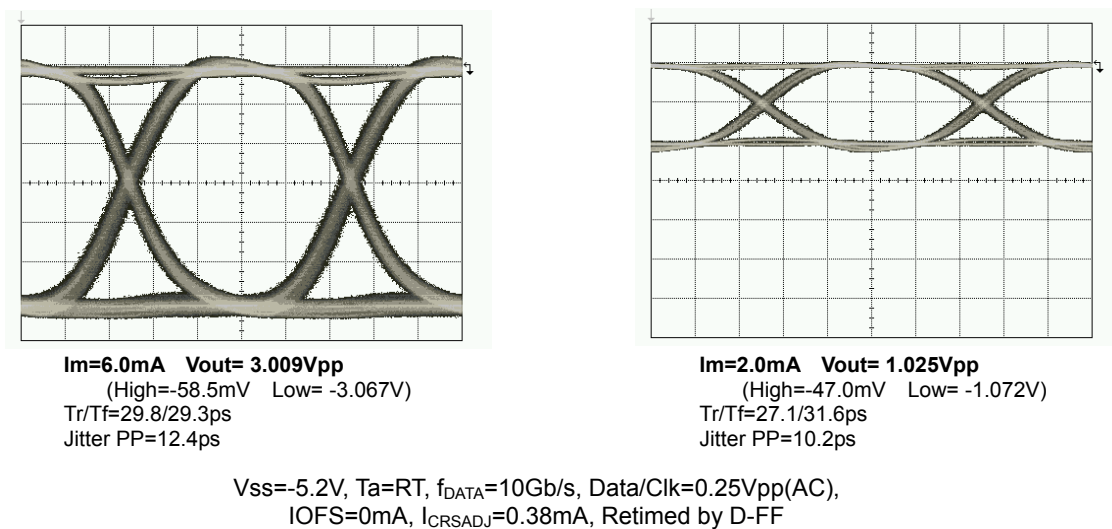

Figure 3. ML0CP18 (Bare die) Output Waveform

BUILT-IN D-FF

The ML0XX18 has an internal D-FF to retime the data by the clock supplied from an external source. To use the D-FF retiming operation, connect CSEL to GND. On the other hand, by connecting CSEL to VEE, an integrated selector SEL will bypass the D-FF, and shut down the power supply of the D-FF and the clock input buffer. The power down feature at the non-retiming operation reduces the power dissipation of the ML0XX18.

OUTPUT WAVEFORM ADJUSTMENT

The ML0XX18 has output waveform adjustment capabilities of output swing, offset level, and output cross-point.

The output voltage swing can be controlled by IM of Modulation Current Control block. Figure 4(a) shows the characteristics of output swing control.

The output offset level can be adjusted by IOFS. The output offset level is defined as the high level of output waveform to GND. Figure 4(b) shows an offset control example. ICRSADJ is the current control input of cross point adjustment as shown in Figure 4(c).

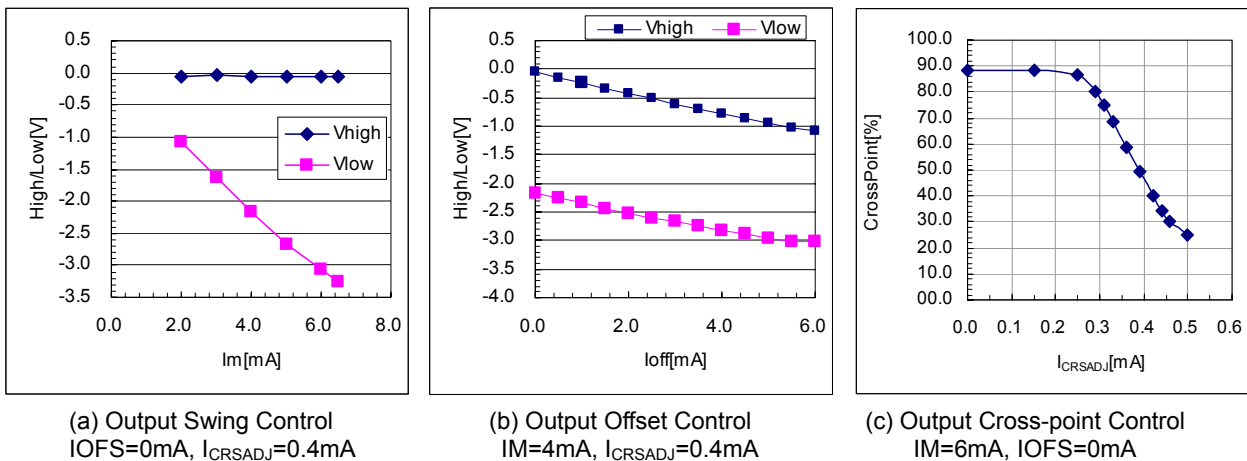

Vss=-5.2V, Ta=RT, fDATA=10Gb/s, Data/Clk=0.25Vpp(AC)

Figure 4. ML0XX18 Control Characteristics

PACKAGE DESCRIPTION (ML01618)

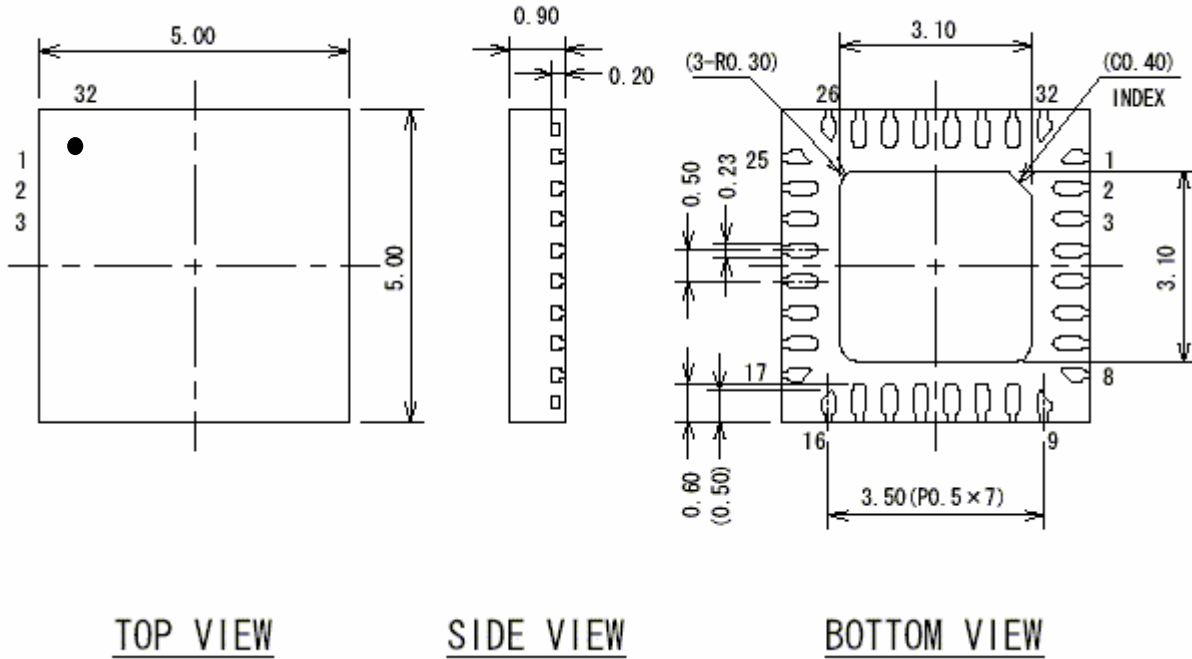
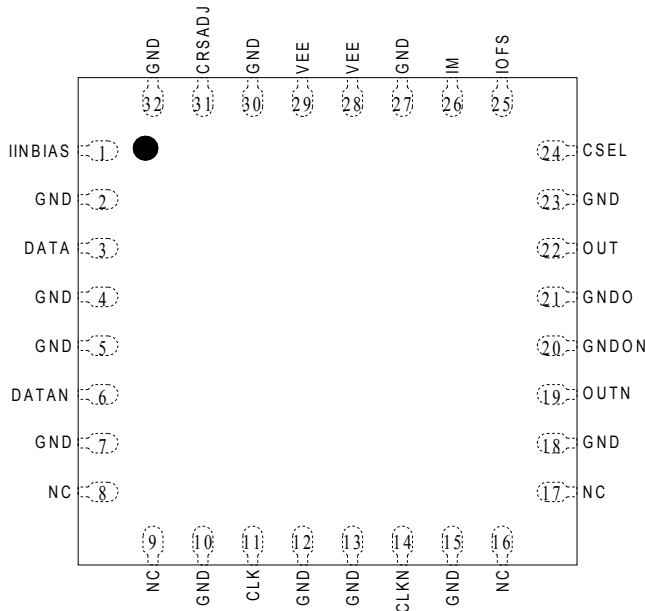

Figure 5. Package Drawing of 32-pin Small Lead-frame Package (SLP)



- Exposed die pad portion on the back side of SLP needs to be connected to GND. In other words, when VEE is supplied by -5.2V, supply 0V to the die pad. In the case of positive power supply (+5.2V to GND terminals and 0V to VEE), supply +5.2V to the die pad. For the detailed information for the positive power supply usage, please contact to your local rep.
- The pins specified as NC need to be left "OPEN".
- Pin 21"GNDO", pin 20"GNDON" and pin 32"GND" are not connected to "GND" line inside chip. Connect these pins to GND externally.

Figure 6. Pin assignment of ML01618 (SLP)

PAD ASSIGNMENT (ML0CP18)

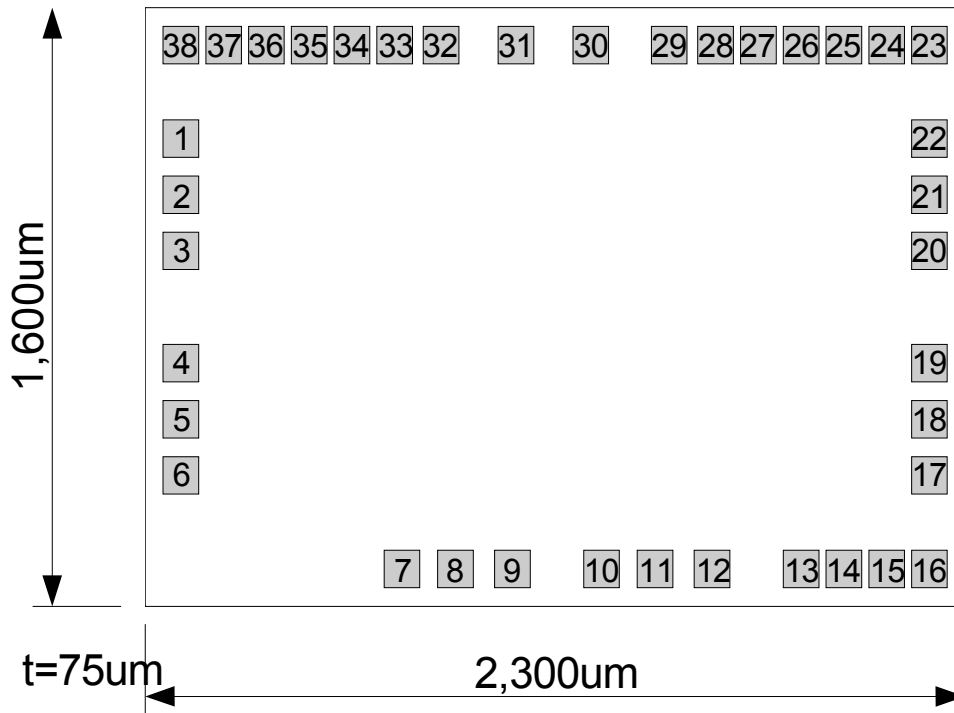

- The back side of die needs to be connected to GND. In other words, when VEE is supplied with -5.2V, supply 0V to the backside. In the case of positive power supply (+5.2V to GND terminals and 0V to VEE), supply +5.2V to the backside. For the detailed information for the positive power supply usage, please contact to your local rep.
- The pads specified as NC need to be left "OPEN".
- Pad 19"GNDON", pad 20"GND0" and pad 36"GND" are not connected to "GND" line inside chip. Connect these pads to GND externally.

Figure 7. Pad assignment of ML0CP18 (Bare Die)

PAD DESCRIPTION (ML0CP18)

PAD No.	Symbol	Description	Center Coordinates	Sizes	PAD No.	Symbol	Description	Center Coordinates	Sizes
1	GND	Ground	(105, 1250)	90x90	20	GNDO	Ground for OUT	(2195, 950)	90x90
2	DATA	Data Input Positive	(105, 1100)	90x90	21	OUT	Data Output Positive	(2195, 1100)	90x90
3	GND	Ground	(105, 950)	90x90	22	GND	Ground	(2195, 1250)	90x90
4	GND	Ground	(105, 650)	90x90	23	CSEL	Re-timing/Non Re-timing Select Input	(2195,1495)	90x90
5	DATAN	Data Input Negative	(105, 500)	90x90	24	NC	No Connection	(2075,1495)	90x90
6	GND	Ground	(105, 350)	90x90	25	IOFS	Positive Output Offset Voltage Control Current	(1955,1495)	90x90
7	GND	Ground	(700, 105)	90x90	26	NC	No Connection	(1835,1495)	90x90
8	CLK	Clock Input Positive	(850, 105)	90x90	27	IM	Output Swing Control Current	(1715,1495)	90x90
9	GND	Ground	(1000, 105)	90x90	28	NC	No Connection	(1595,1495)	90x90
10	GND	Ground	(1300, 105)	90x90	29	VEE	Supply Voltage	(1465,1495)	90x90
11	CLKN	Clock Input Negative	(1450, 105)	90x90	30	VEE	Supply Voltage	(1255,1495)	90x90
12	GND	Ground	(1600, 105)	90x90	31	VEE	Supply Voltage	(1045,1495)	90x90
13	NC	No Connection	(1835, 105)	90x90	32	VEE	Supply Voltage	(835,1495)	90x90
14	NC	No Connection	(1955, 105)	90x90	33	NC	No Connection	(705,1495)	90x90
15	NC	No Connection	(2075, 105)	90x90	34	ICRSADJ	Cross Point Adjust Control Current	(585,1495)	90x90
16	NC	No Connection	(2195, 105)	90x90	35	NC	No Connection	(465,1495)	90x90
17	GND	Ground	(2195, 350)	90x90	36	GND	Ground	(345,1495)	90x90
18	OUTN	Data output Negative	(2195, 500)	90x90	37	NC	No Connection	(225,1495)	90x90
19	GNDON	Ground for OUTN	(2195, 650)	90x90	38	IIBIAS	Input Bias Level Control Current	(105,1495)	90x90

NOTIFICATION FOR BARE DIE SUPPLY (ML0CP18)

1. Quality

After the reception of bare die by the customer, performance, yield and reliability of the application of the bare die will not be guaranteed. The supplier does not have the responsibility for field failures in the applied product.

2. Storage

a) Store in dry nitrogen.

< Before opening shipped conductive film bag (dry N2 sealed) >

Temperature : 15 to 35 deg. C

Humidity : 45% - 75% RH

Term : 3 months

< After opening >

Temperature : 15 to 35 deg. C

Atmosphere : Dry N2 gas

(The dew point should be less than -30 deg. C)

(No contact with gas including ammonia and sulfur)

Term : The appearance of the bare die is not guaranteed after its opening.

b) Don't apply excess vibration or shock.

3. Opening a package

a) Handle devices in clean room or on clean bench.

b) Take measures to avoid electro-static damage.

c) To open a film bag, please use scissors or a knife.

d) When taking out the devices, never touch devices barehanded. Please use clean tweezers or similar.

When use tweezers, please catch a device by side to avoid cracking or damaging the device.

Since gallium arsenide is more brittle material than silicon, special care must be taken.

4. Die bonding

The following methods are recommended for die bonding.

a) Die should be bonded lower than 300 deg. C.

b) The time duration of die bonding at maximum temperature is recommended to be shorter than 15 sec.

c) Cool down gradually, to avoid chip crack.

d) All die bonding equipment and workers should be grounded.

5. Wire bonding

The following methods are recommended for wire bonding.

a) Bonding force of wire bonding is recommended to be less than 55 grams with ultrasonic.

b) Check ultrasonic power not to damage on die and die pads.

c) Cool down gradually.

d) All wire bonding equipment and workers should be grounded.

6. Design

a) It is recommended to use this product in a hermetic sealed condition (N2 sealed).

b) It is recommended for customer to verify the performance and the qualification by customer's final product.

Especially, oscillation and noise generation might happen.