

MOS FIELD EFFECT TRANSISTOR  
2SK2137

SWITCHING  
N-CHANNEL POWER MOS FET  
INDUSTRIAL USE

DESCRIPTION

The 2SK2137 is N-Channel MOS Field Effect Transistor designed for high voltage switching applications.

FEATURES

- Low On-Resistance  
2SK2137:  $R_{DS(on)} = 2.4 \Omega$  ( $V_{GS} = 10 V, I_D = 2.0 A$ )
- Low  $C_{iss}$   $C_{iss} = 550 pF$  TYP.
- High Avalanche Capability Ratings
- Isolate TO-220 Package

ABSOLUTE MAXIMUM RATINGS ( $T_A = 25 \text{ }^\circ\text{C}$ )

Drain to Source Voltage	$V_{DSS}$	600	V
Gate to Source Voltage	$V_{GSS}$	$\pm 30$	V
Drain Current (DC)	$I_{D(DC)}$	$\pm 4.0$	A
Drain Current (pulse)*	$I_{D(pulse)}$	$\pm 16$	A
Total Power Dissipation ( $T_c = 25 \text{ }^\circ\text{C}$ )	$P_{T1}$	30	W
Total Power Dissipation ( $T_A = 25 \text{ }^\circ\text{C}$ )	$P_{T2}$	2.0	W
Channel Temperature	$T_{ch}$	150	$^\circ\text{C}$
Storage Temperature	$T_{stg}$	$-55$ to $+150$	$^\circ\text{C}$
Single Avalanche Current**	$I_{AS}$	4.0	A
Single Avalanche Energy**	$E_{AS}$	5.3	mJ

\*  $PW \leq 10 \mu s$ , Duty Cycle  $\leq 1 \%$

\*\* Starting  $T_{ch} = 25 \text{ }^\circ\text{C}$ ,  $R_G = 25 \Omega$ ,  $V_{GS} = 20 V \rightarrow 0$

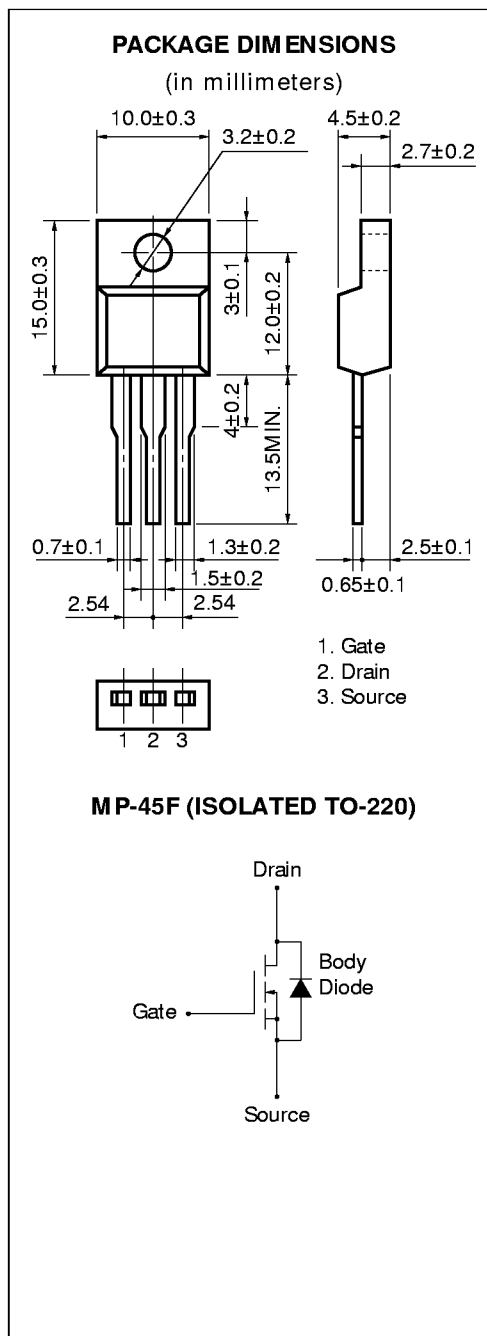

**ELECTRICAL CHARACTERISTICS (T<sub>A</sub> = 25 °C)**

CHARACTERISTIC	SYMBOL	MIN.	TYP.	MAX.	UNIT	TEST CONDITIONS
Drain to Source On-State Resistance	R <sub>DS(on)</sub>		1.7	2.4	Ω	V <sub>GS</sub> = 10 V, I <sub>D</sub> = 2.0 A
Gate to Source Cutoff Voltage	V <sub>GS(off)</sub>	2.5		3.5	V	V <sub>DS</sub> = 10 V, I <sub>D</sub> = 1 mA
Forward Transfer Admittance	y <sub>fs</sub>	1.0			S	V <sub>DS</sub> = 10 V, I <sub>D</sub> = 2.0 A
Drain Leakage Current	I <sub>DSS</sub>			100	μA	V <sub>DS</sub> = V <sub>DSS</sub> , V <sub>GS</sub> = 0
Gate to Source Leakage Current	I <sub>GSS</sub>			±100	nA	V <sub>GS</sub> = ±30 V, V <sub>DS</sub> = 0
Input Capacitance	C <sub>iss</sub>		550		pF	V <sub>DS</sub> = 10 V
Output Capacitance	C <sub>oss</sub>		130		pF	V <sub>GS</sub> = 0
Reverse Transfer Capacitance	C <sub>rss</sub>		25		pF	f = 1 MHz
Turn-On Delay Time	t <sub>d(on)</sub>		11		ns	I <sub>D</sub> = 2.0 A
Rise Time	t <sub>r</sub>		6		ns	V <sub>GS(on)</sub> = 10 V
Turn-Off Delay Time	t <sub>d(off)</sub>		45		ns	V <sub>DD</sub> = 150 V
Fall Time	t <sub>f</sub>		7		ns	R <sub>G</sub> = 10 Ω R <sub>L</sub> = 75 Ω
Total Gate Charge	Q <sub>G</sub>		20		nC	I <sub>D</sub> = 4.0 A
Gate to Source Charge	Q <sub>GS</sub>		4		nC	V <sub>DD</sub> = 480 V
Gate to Drain Charge	Q <sub>GD</sub>		10		nC	V <sub>GS</sub> = 10 V
Body Diode Forward Voltage	V <sub>F(S-D)</sub>		1.0		V	I <sub>F</sub> = 4.0 A, V <sub>GS</sub> = 0
Reverse Recovery Time	t <sub>rr</sub>		320		ns	I <sub>F</sub> = 4.0 A, V <sub>GS</sub> = 0
Reverse Recovery Charge	Q <sub>rr</sub>		1.2		μC	di/dt = 50 A/μs

**Test Circuit 1 Avalanche Capability**

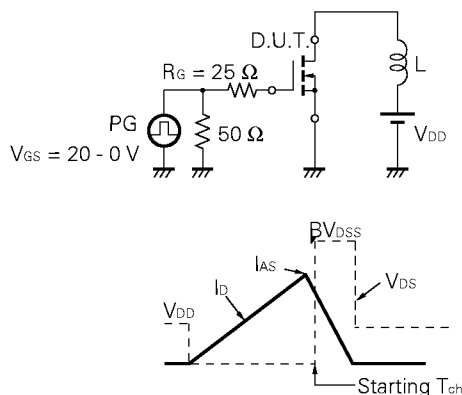

**Test Circuit 2 Switching Time**

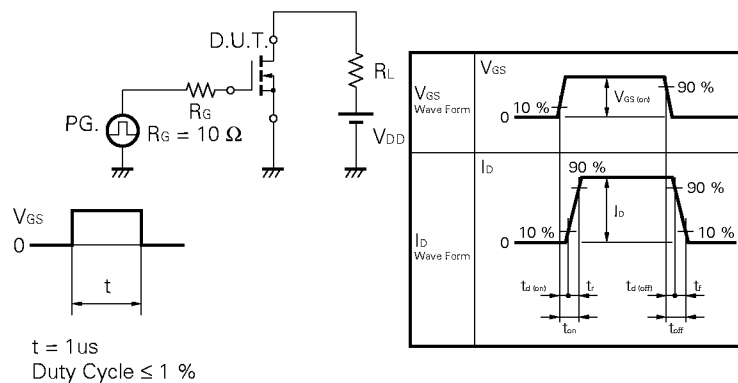

**Test Circuit 3 Gate Charge**

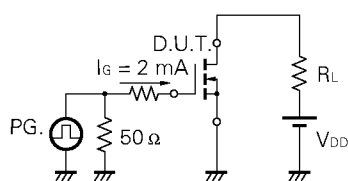

The application circuits and their parameters are for references only and are not intended for use in actual design-in's.

TYPICAL CHARACTERISTICS (T<sub>A</sub> = 25 °C)

DERATING FACTOR OF FORWARD BIAS SAFE OPERATING AREA

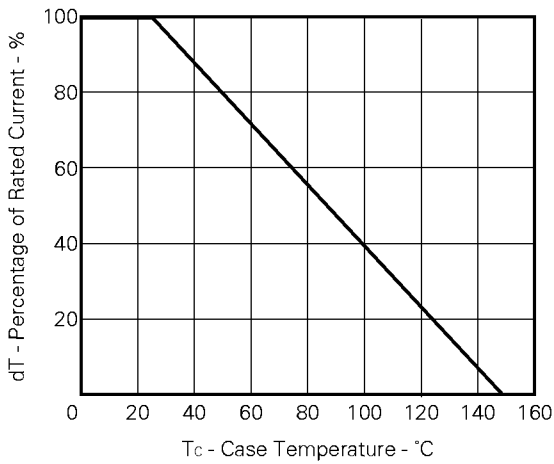

TOTAL POWER DISSIPATION vs. CASE TEMPERATURE

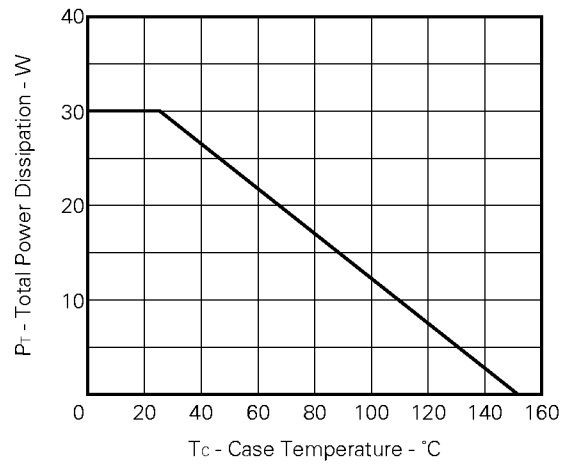

FORWARD BIAS SAFE OPERATING AREA

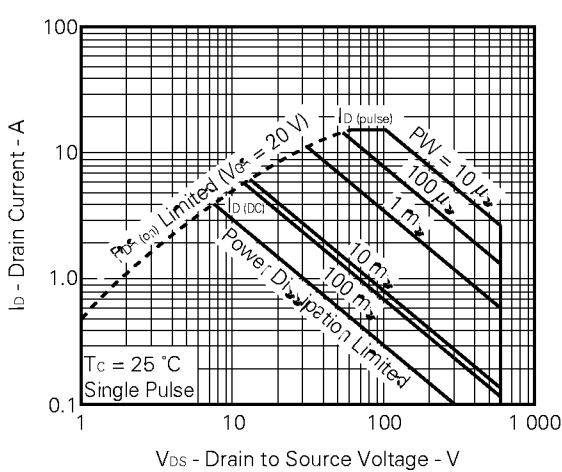

DRAIN CURRENT vs. DRAIN TO SOURCE VOLTAGE

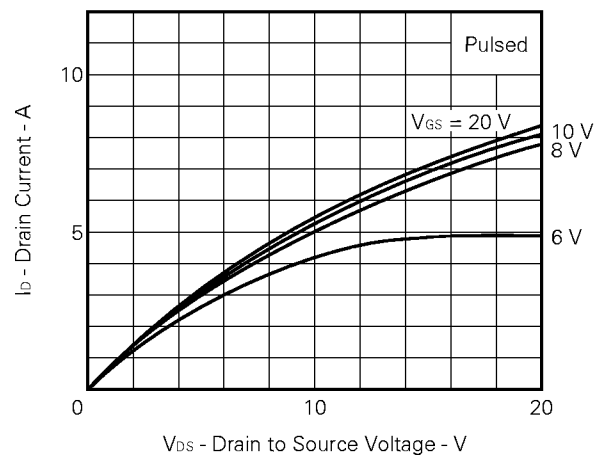

DRAIN CURRENT vs. GATE TO SOURCE VOLTAGE

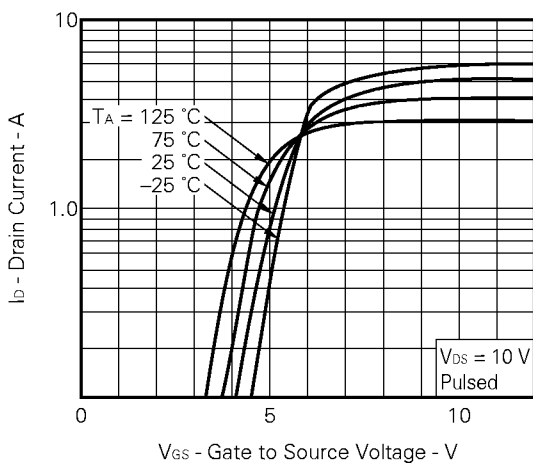

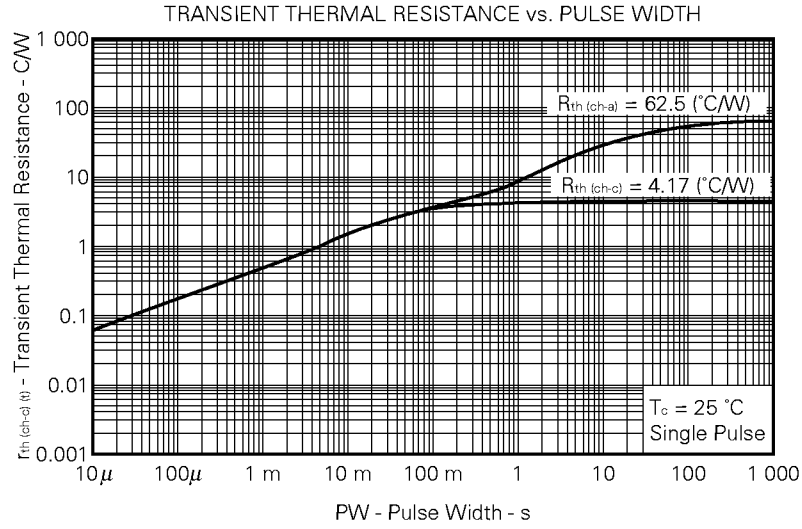

www.DataSheet4U.com

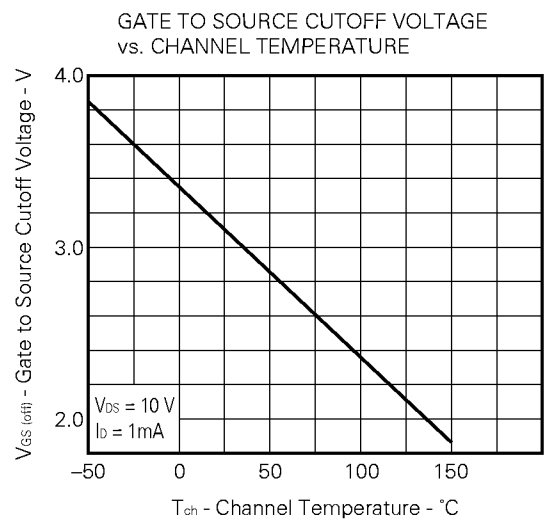
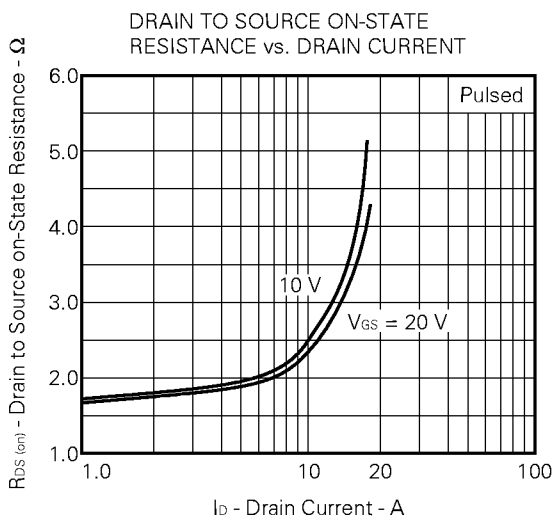
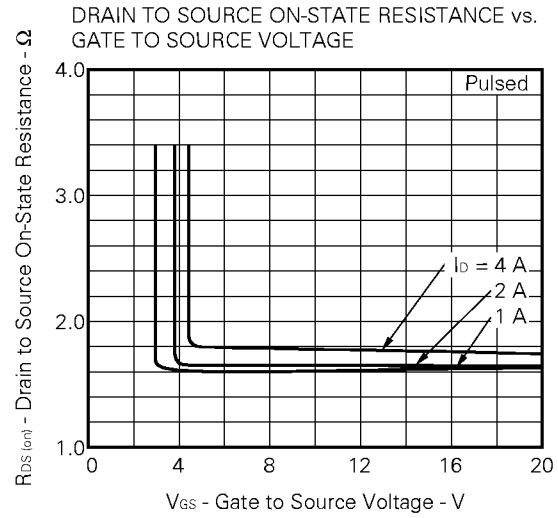
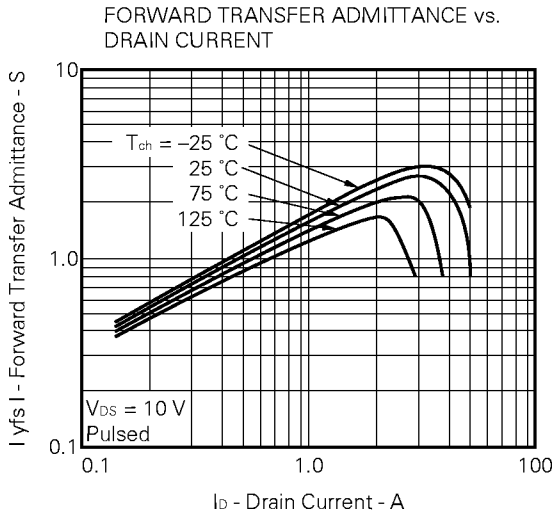

DRAIN TO SOURCE ON-STATE RESISTANCE vs. CHANNEL TEMPERATURE

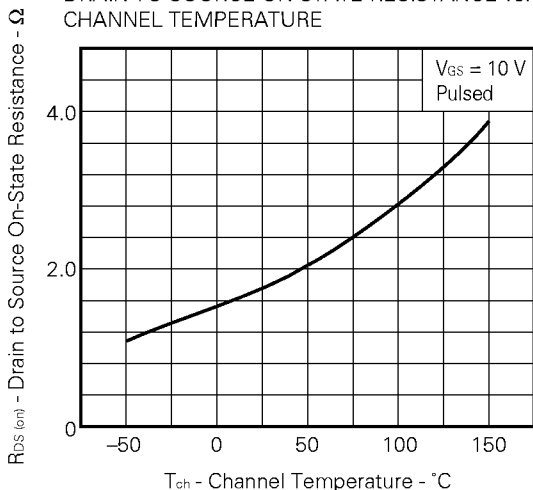

SOURCE TO DRAIN DIODE FORWARD VOLTAGE

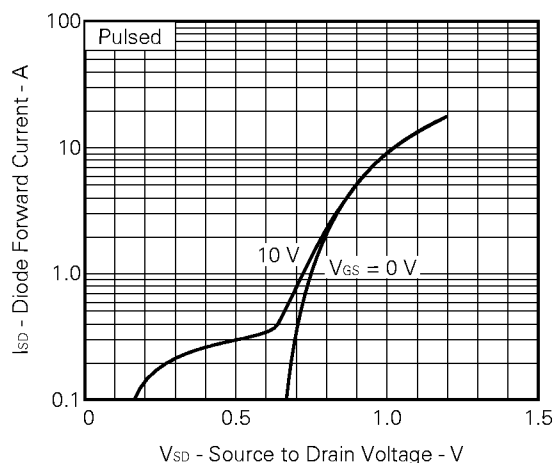

CAPACITANCE vs. DRAIN TO SOURCE VOLTAGE

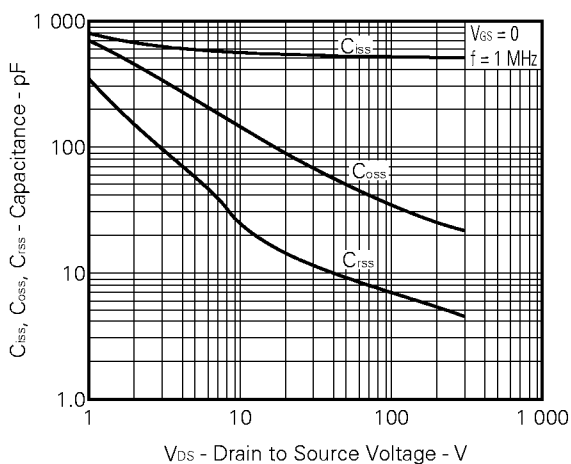

SWITCHING CHARACTERISTICS

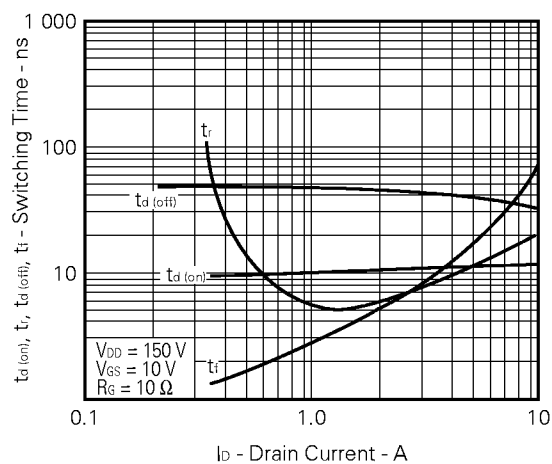

DYNAMIC INPUT CHARACTERISTICS

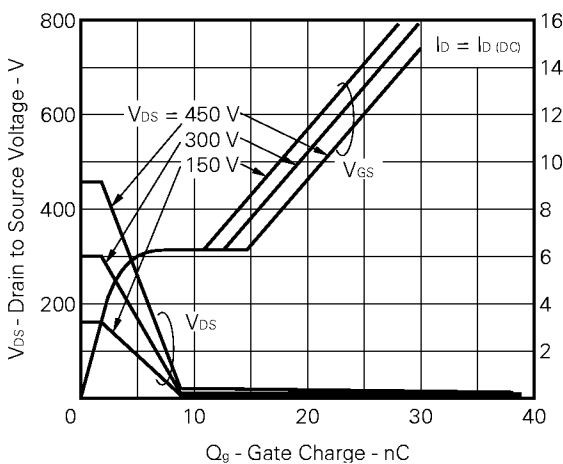

REVERSE RECOVERY TIME vs. DRAIN CURRENT

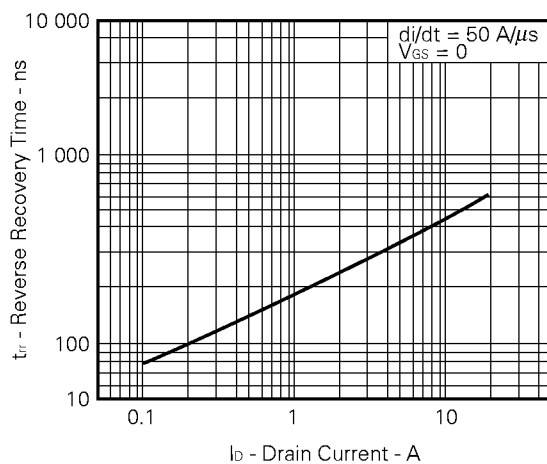

SINGLE AVALANCHE CURRENT vs. INDUCTIVE LOAD

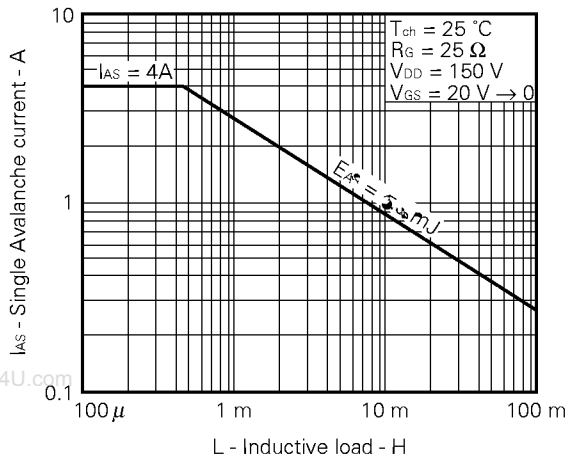

SINGLE AVALANCHE ENERGY vs. STARTING CHANNEL TEMPERATURE

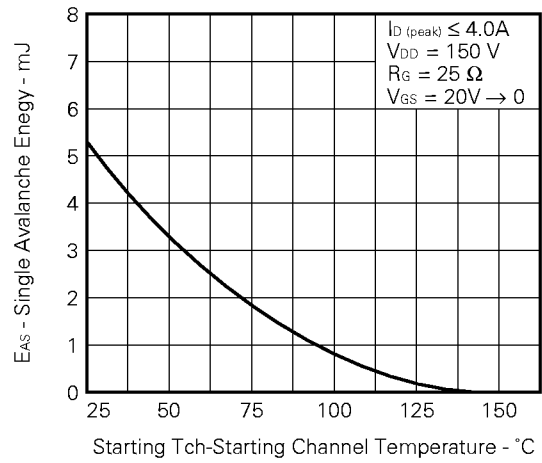

www.DataSheet4U.com