



www.datasheet4u.com

**Electronic Design & Research Inc.**  
<http://www.vsholding.com>

## Universal SPDT/DPST Solid-State Relays

### Technical Information

**DPST relays with two isolated pairs, 2A and 2B, or 1A+1B terminals configuration for DC and AC/DC applications.**

**A 2 Form B terminals are true normally closed pair a family of the uniquely designed Solid State Relay/Switch.**

Under management



VS Holding LLC  
[www.vsholding.com](http://www.vsholding.com)

www.DataSheet4U.com

## INTRODUCTION

Solid-State Relays/Switches from Electronic Design & Research offers a broad range of functions from a basic normal open and normal close relays to a bus-compatible, fuzzy logic input high-speed drivers, power distribution modules made for motorcycles, power boats, etc. and solid-state breakers. Some EDR's devices are pin-for-pin and functionally comparable to similar relays accepted in the industry and manufacture by other company, and most of them grow to be the standard by itself.

[www.datasheet4u.com](http://www.datasheet4u.com)

Devices included in this publication offer speed and power capability with low power dissipation the way beyond what is available in the industry today. A precise control of turning-on and turning-off timing allows using high-power DPST devices as ½ drivers (or as a true SPDT relay) simplifies designing a high-power controlling and driving equipment. A SIP-packaging is especially attractive for use in the systems where a board space is critical.

## IMPORTEN NOTICE

Electronic Design & Research (EDR) reserves the right to make changes to or to discontinues any production or service identified in this publication without notice. EDR advises its customers to obtain the latest version of the relevant information to verify, before placing orders, that the information presented is current.

EDR warrants performance of its product to current specification in according with EDR's standard warranty. Testing and other quality control techniques are utilized to the extend EDR deems necessary to support this warranty. Unless mandated by government requirements, specific testing of all parameters of each device in not necessarily performed.

EDR assumes no liability for EDR applications assistance, customer product design, or infringement of patent or services described herein. Nor does EDR warrant or represent that any license, either express or implied, is granted under any patent right, copyright, mask work right, or other intellectual property rights of EDR covering or relating to any combination, machine, or process in which such modules products or services might be or are used.

There are plenty of an electromechanical normal-close relays on the market but if a high-current, high-voltage power must be controlled a solid-switch is the best choice. Many companies and so EDR manufacture varieties of normal-open switches and until now only a low-power normal-close switch was available on the market. This publication is about our newest family of unique solid-state devices. We proud to offer you a family of high-current, normal-close/normal-close DPST relays that can be used as a SPDT relay, or as a break-before-make analog switch, or as a ½ driver. This publication included the Ordering Instruction. You can create a new part number, for your unique application that required a different voltage, current or speed following the Instruction. Please, do not hesitate to send an email to: [info@vsholding.com](mailto:info@vsholding.com) for any additional information, delivery schedule and prices.

Thank you,

Vladimir A. Shavrtsman, Ph.D.  
President & CEO

[V\\_Shavrtsman@vsholding.com](mailto:V_Shavrtsman@vsholding.com)

[www.DataSheet4U.com](http://www.DataSheet4U.com)

From the creation time, Electronic Design & Research Inc. is working to satisfy, as it looks like an endless flow of requirements for a new and unique products and technology. We gave life in 1982 to a neural-cell technology and now a new branch of science Neural Networks is flourishing. Based on that invention we introduced in 1984 a Multichannel signal processor, which for the first time detected a faint signal from the heart from the body surface. Since 1998, we put a heavy emphasis on developing varieties of modules, such as solid-state relays, drivers and switches. Our modules are working in many critical applications providing a power inside of super-power, redundant servers installed on submarines, control movements of chairs in iMax Theatres,

One of the most popular relays from that family (p/n EDR82450 with a 2 FORM A wiring diagram) has found application in high-speed printers. Precise turning on/off timing allows connecting both terminals for a large current capacitance and that is exactly what was exploited by one of our customer for controlling a heavy, fast machinery.

Recently, we expended the family with adding more advance switching products. A new relay (p/n EDR82308) with 1A+1B terminal configurations employed that is used can be found only in advanced analog and sophisticated switches. An internal electronic insures and guarantees that there is no shoot-through current when and if a N.C. (normal close) pair and a N.O. (normally open) terminals wired in series. Only expensive ½-bridge drivers and analog switches so far offered such precision switching. It is a fast, powerful relay and more appropriate is a switch rated at 20 amps @ 75VDC. For the first time in the industry, the EDR82308 provides a high-current, normally close solid-state relay.

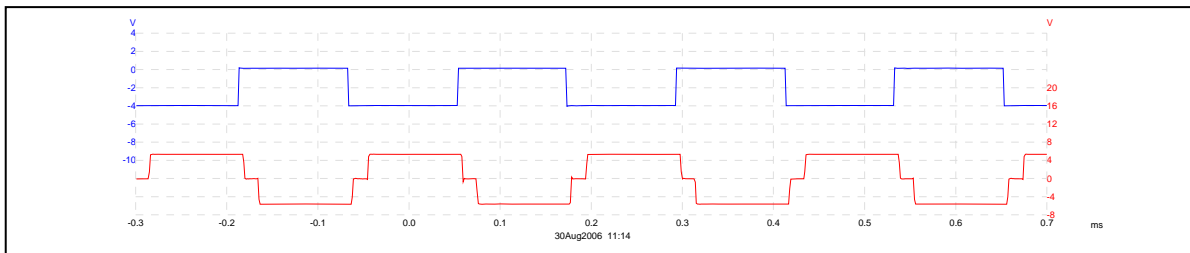

**The EDR82308 with two pair of terminals (one is N.C. and the other N.O.) can work, as a driver when terminals connected in serious and a load is common.**

The EDR82308 manufactured with newest, patented by VS Holding Inc. technology. Based on the same principal EDR Inc. offers large varieties of relay/switches varies in output voltage and current ratings and packaging. All relays/switches designed to handle either DC or AC power. In some applications devices offered to control only a DC power, which allows manufacture smaller, less expensive devices. A relay/switch built to control a DC power only delivers twice more current in the same package.

The internal control circuitry allows the driver, large varieties of powerful MOSFETs and as the result of that; we offer a large variation of relays to switch a DC and DC/AC power. Please send us an inquiry. We do not charge a set-up production fee for an order of 200 relays and up.



**Electronic Design & Research**  
<http://www.vsholding.com>

*Technology for people's ideas*

[www.datasheet4u.com](http://www.datasheet4u.com)

# H4N75D20/24/C

## Powerful, N.C./N.O. Solid State Relay

Designed to control 20 A, 75VDC in microseconds

**Features:** Utilizes only 1.84 sq. in. of PCB area and only 1.2" tall  
 20 Amp continuous or up to 160 Amp-pick in miniature size  
 High sensitivity, even at a high switching frequency  
 300 A surge current, and only 10 mill-Ohms low-state resistance  
 24V input, and only 20 mA

### Input Specifications:

Input DC Voltage	24 VDC or 12 VDC
Nominal Current, at 10 Hz	12mA      18mA
Maximum Current, at 1 KHz	13 mA      20mA
Maximum Current, at 25 KHz	16 mA      23mA

### Output Specifications:

Operating DC voltage range	0 – 75 VDC
Maximum continuous current	20A rms
Maximum surge current (IDM)	300A @ 1.0ms
Continues current (ID)	160A @ 25 °C
Maximum on-state resistance	0.010 Ohm
Rising time	0.5 μS
Delay-on time	7.5 μS
Falling time	0.2 μS
Delay-off time	21.2 μS
Maximum switching frequency	25.0 KHz

### General Specifications:

Ambient operating temperature range	-50 <sup>0</sup> C to 55 <sup>0</sup> C
Ambient storage temperature range	-40 <sup>0</sup> C to 150 <sup>0</sup> C
Dialectic Strength input-to-output	3000VAC
Dialectic Strength between terminals	3000VAC

### Mechanical Specifications:

Weight(oz)	.5
Encapsulation	ResTech 10207/053
Terminals; input/output	.040"/0.60" diameter
Dimensions	.115"Hx2.0"Lx.92"W

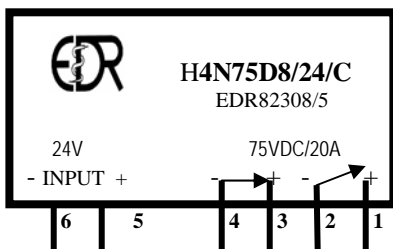
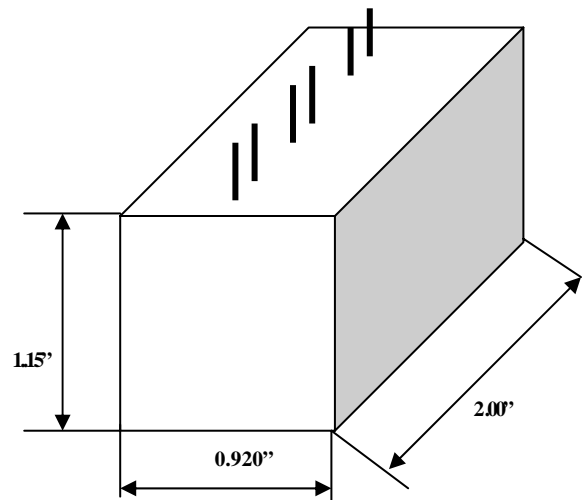
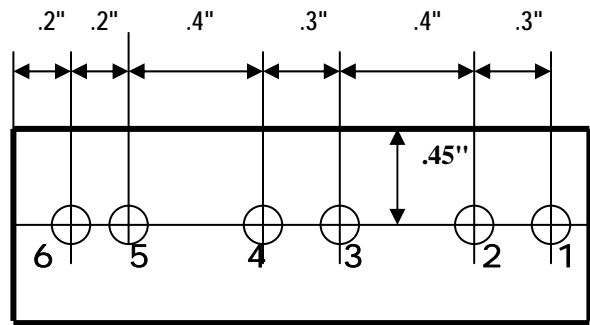
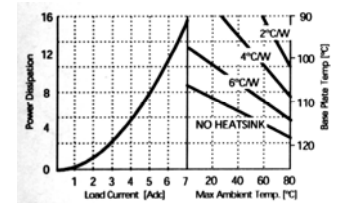
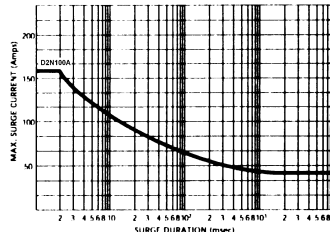

Transient Protection: All loads are inductive, even ones that are not so obvious or labeled. An inductive load produces a harmful transient voltage, which is much higher than the applied voltage, when it is turned on and off. A SSR built with a MOSFET output acts as an ideal switch and can produce a seemingly "non-inductive" load, which can cause damage if not suppressed. A transient voltage suppressor, which is bi-directional for an AC applied voltage and unidirectional for a DC applied voltage, should be used to clamp excessive spikes.

**Electronic Design & Research Inc. \*\* 7331 Intermodal Dr. \*\* Louisville \*\* KY 40258**

Tel: 502-933-8660; Fax: 502-933-3422; Sales: 800-336-1337; e-mail: [vsholding@vsholding.com](mailto:vsholding@vsholding.com)

[www.DataSheet4U.com](http://www.DataSheet4U.com)

The DPST relay (p/n EDR82308) is unique in its class. Below are time-diagrams snap-shorts prepared for better understanding time-responses of the relay on a single pulse. Both terminals, normally closed and normally open operate in similar ways but there is a slight timing difference to insure EDR82308 will be able to work as a SPDT relay, or as a 1/2 bridge driver, or as an analog switch.

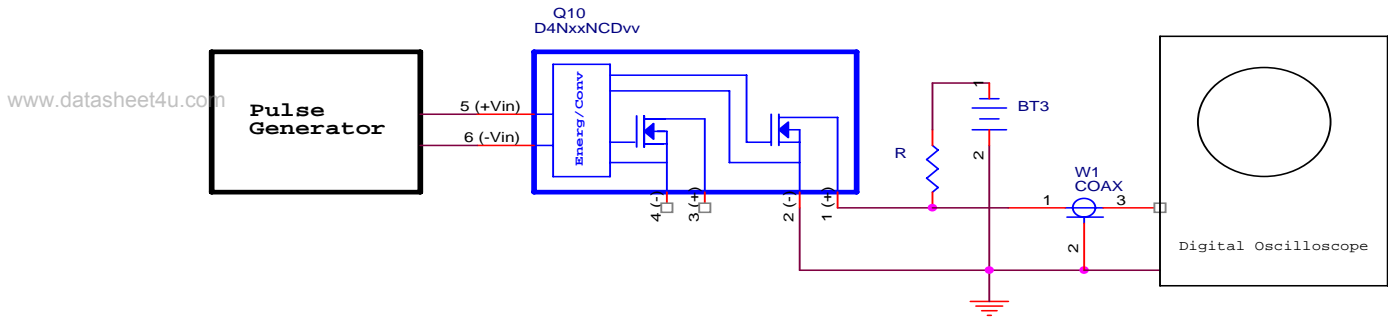

**Figure 1** A hook-up setting for performing test of a normal-opened (N.O.) pair

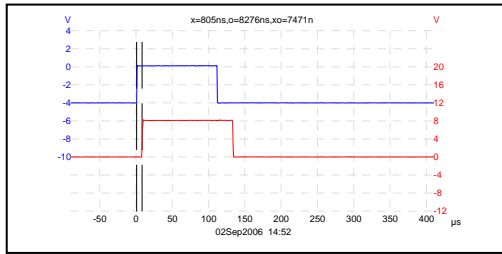

**Fig. 2.** Turn-on delay is about 8 $\mu$ S

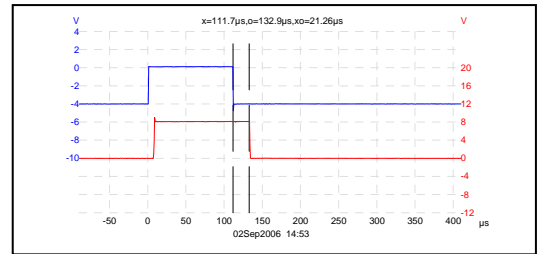

**Fig. 3.** Turn-off delay is 22 $\mu$ S

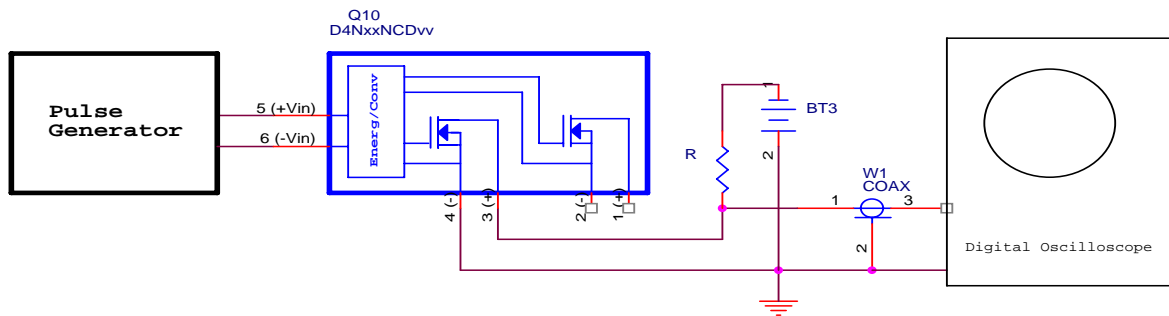

**Figure 4** A hook-up setting for performing test of a normal-closed (N.C.) pair

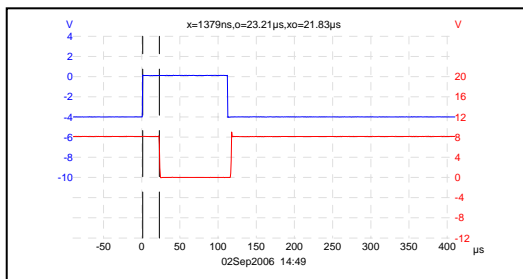

**Figure 5.** Turn-on delay is 22 $\mu$ S

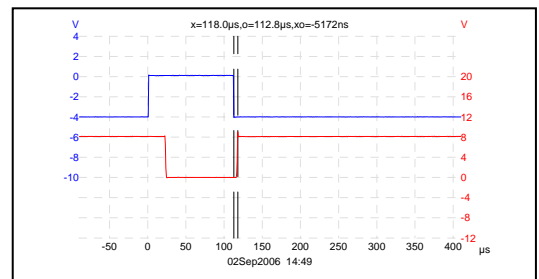

**Figure 6.** Turn-off delay is 5.2 $\mu$ S

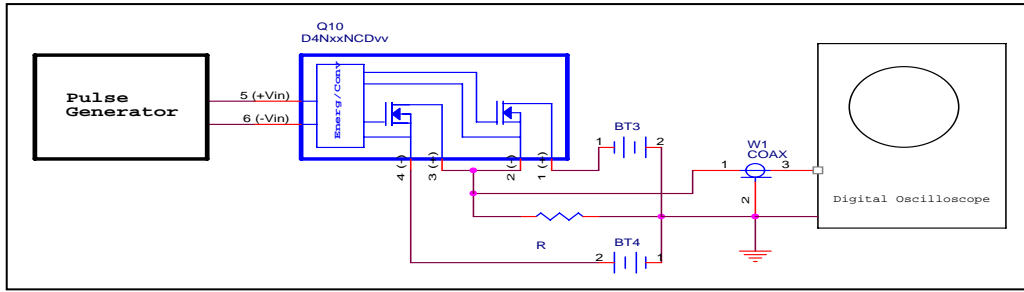
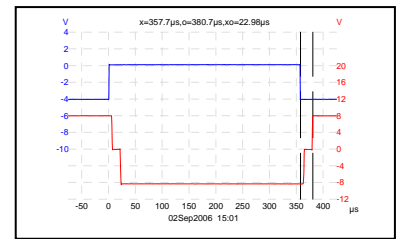
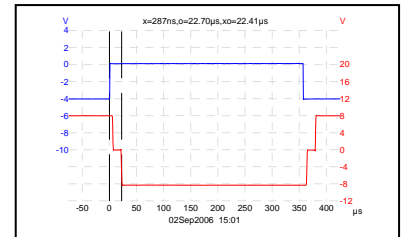
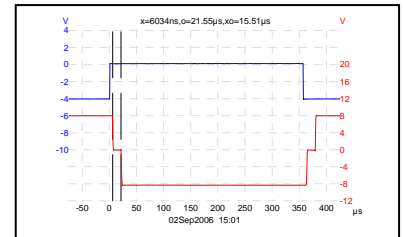
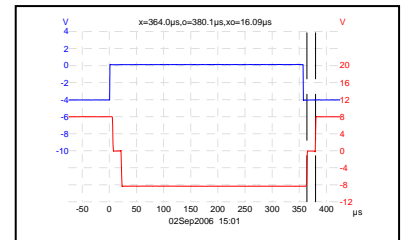
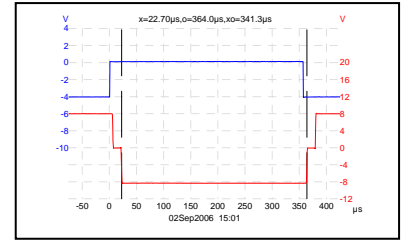
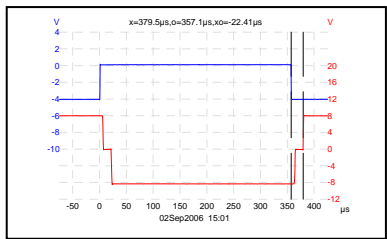
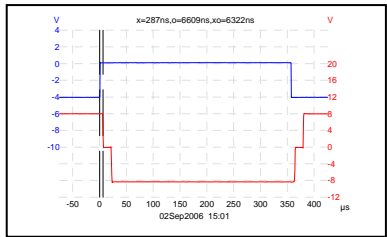
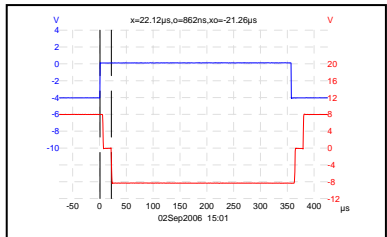
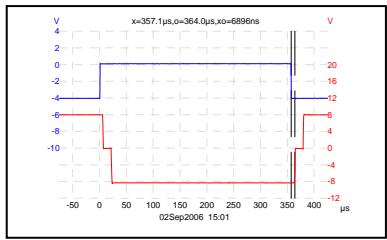
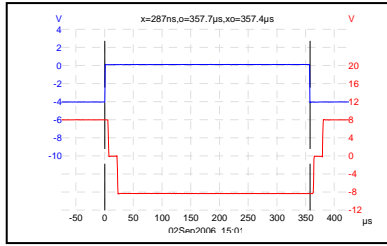

Figure 6. A hook-up setting for performing test as a SPDT relay/switch



Occurred timing relationship between an input signal (pulse) and output signal (pulse) at a load.



**Electronic Design & Research**  
<http://www.vsholding.com>

*Technology for people's ideas*

[www.datasheet4u.com](http://www.datasheet4u.com)

# H6N200A2/24/C

## Powerful, N.C./N.O. Solid State Relay

Designed to control 2A at +/-200VDC in microseconds

**Features:** Utilizes less than 1 sq. in. of PCB area and only 1.3" tall  
 2.2 Amp continuous or up to 17 Amp-pick in miniature size  
 High sensitivity, even at a high switching frequency  
 70 A surge current, and only .20 mill-Ohms low on-state resistance  
 24V input, and only 20 mA

### Input Specifications:

Input DC Voltage	24 VDC or 12 VDC
Nominal Current, at 10 Hz	12mA      18mA
Maximum Current, at 1 KHz	13 mA      20mA
Maximum Current, at 25 KHz	16 mA      23mA

### Output Specifications:

Operating DC voltage range	+/- 200 VDC/140AVC
Maximum continuous current	2.2A rms
Maximum surge current (IDM)	70A @ 1.0ms
Continues current (ID)	17A @ 25 °C
Maximum on-state resistance	0.22 Ohm
Rising time	0.5 μS
Delay-on time	7.5 μS
Falling time	0.2 μS
Delay-off time	21.2 μS
Maximum switching frequency	25.0 KHz

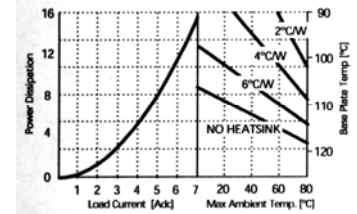
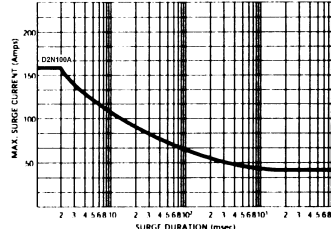

### General Specifications:

Ambient operating temperature range	-50 <sup>0</sup> C to 55 <sup>0</sup> C
Ambient storage temperature range	-40 <sup>0</sup> C to 150 <sup>0</sup> C
Dialectic Strength input-to-output	3000VAC
Dialectic Strength between terminals	3000VAC
Mechanical Specifications:	
Weight(oz)	.5
Encapsulation	ResTech 10207/053
Terminals; input/output	.040"/0.60" diameter
Dimensions	.1.15"Hx2.0"Lx.92"W

H8N200V2/24/C

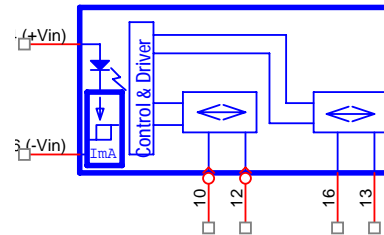

**Simplified block-diagram of the relay**

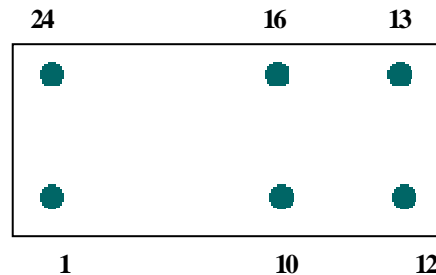
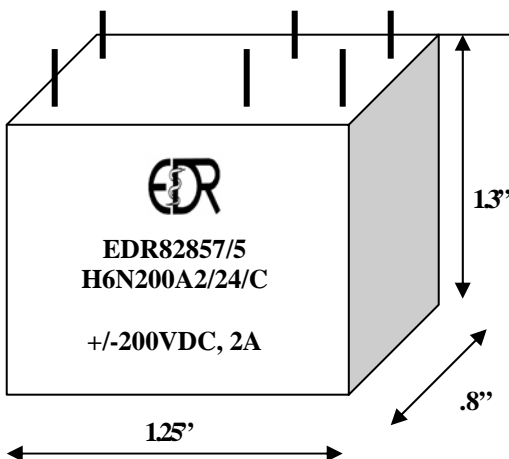

**View from the bottom:**

- 1 – Control signal
- 10&12 – N.C. pair
- 13 & 16 – N.O. pair
- 20 – Control signal

Transient Protection: All loads are inductive, even ones that are not so obvious or labeled. An inductive load produces a harmful transient voltage, which is much higher than the applied voltage, when it is turned on and off. A SSR built with a MOSFET output acts as an ideal switch and can produce a seemingly "non-inductive" load, which can cause damage if not suppressed. A transient voltage suppressor, which is bi-directional for an AC applied voltage and unidirectional for a DC applied voltage, should be used to clamp excessive spikes.



## Selection and Ordering Instruction for EDR's made Solid State Modules such as Relays, Switches, Breakers, 1/2 and H-bridge Drivers, etc.

Notes: During past ten years rapid development of new and additional [products gave us no choice but to expend, modify and unify part descriptions. Below is our third modification since 1997. A module described according to the specifications below but the p/n EDRxxxxx will stay the same for already items in circulation (already sold).

X    A    B    C    E    F    /H    /I    /Z    /0    /V

**“X” module type**

www.datasheet4u.com

- D Solid State Relay
- H Driver, such as 1/2-bridge and H-bridge Driver
- V Fast High Voltage Solid-State Switches with Nanoseconds rise time
- B Solid State Breaker and brakes control modules

**“A” package dimensions**

- 1 0.615”H x 1.48”L x 0.290”W
- 2 1.15”H x 1.75”L x 0.4”W
- 3 1.15”H x 1.75”L x 0.8”W
- 4 1.15”H x 2.0”L x 0.92”W
- 5 1.15”H x 2.8”L x 1.15”W
- 6 DIP24, 0.375”H x 0.925”L x 0.53”W
- 7 panel mount, 0.82”H x 2.7”L x 2.0”W

**“B” Speed - A device's ability to turn ON/OFF output terminal(s) times per second**

- L a low speed relay/switch, rated DC - 800 Hz, direct driving control, SIP4
- A a low speed relay/switch, AC input relays, SIP4
- N a medium speed relay/switch, rated DC - 25 KHz, direct driving control, SIP4
- G a medium speed relay/switch, rated DC - 25 KHz, low current control and power, SIP5
- F a fast relay/switch, rated up to DC - 350 KHz, low current control and power, SIP5
- S a super-fast relay/switch, rated DC - 1.4 MHz, low current control and power, SIP5
- U a super-fast relay/switch, rated DC - 1.2 MHz, direct driving control, SIP4

**“C” Output Voltage - A maximum allowed voltage between output terminals**

It must be replace with required voltage and we offer the closest and highest value available.

**Note:** In an “AC” -relay a voltage specified a peak-to-peak maximum voltage and the be calculated by multiplying a maximum allowed voltage by factor of 0.7

maximum VAC can

**“E” Output terminals configurations**

- “N” or nothing SPST or 1 Form A output terminals,
- “NN” 2SPST, or 2 Form A output terminals, or DPST
- “NNN” 3SPST, or 3 Form A output terminals
- “T” TOTEM output, break-before-make termination, or NO-NO, or SPDT, or analog switch
- “C” SPST, Normal Close output
- “CN” SPDT, or 1 Form C output terminals
- “NC” DPST with a N.O. and N.C. terminals that can work like a SPDT
- “V” VIDEO switch

**“F” A relay can be use to control either AC, DC or AC/DC power**

- A - a relay/switch designed to switch/chop an AC/DC power
- D - a relay/switch designed to switch/chop a DC power
- “none” - relay with a SCR or TRIAC on the output to control only AC power

**“H” A maximum allowed RMS CURRENT (Ampere) without a heat sink.**

A maximum current limited to a size of the enclosure (box). We can produce a device for any required current in a customer enclosure.

**“I” We offer several standard control voltages; 5VDC, 12VDC, 24VDC and 18-38VDC.**

Please specify the input control voltage, as for example D1L30D12/xx. Replace xx with a 3, 5, 12, 24, 48, 3-20 and 18-38 that is for 3VDC, 5VDC, 12VDC, 24VDC, 48VDC, 3-20VDC and 18-38VDC. Respectful control voltage represented at the end of part number in the following way, for an example EDR82653/1 and EDR82653/8. Both relays are almost the same and difference is only an applied control voltage, “1” if for 3VDC and “8” is for 18-38VDC;

Control Voltage	Representation	Control Voltage	Representation	Control Voltage	Representation
3VDC	1	5VDC	2	12VDC	3
24VDC	4	48VDC	5	26VDC	6
3-20VDC	7	18-38VDC	8	90-120VAC	9

**“I” A power supply required for a relay with an internal DC/DC converter. We offer several standard voltages 5VDC, 12VDC, 24VDC and 48VDC.**

**“Z” A relay/switch built with following standard isolations**

- “L” or “none” type relay is 2500 V
- “N” type relay is 3000V, 4000VDC (“H4”) and 5200 (“H5”) VDC.

**“0” Screening option, (NONE) for industrial, B for Class B, and S for Class S**

-----  
**Electronic Design & Research Inc. \*\* 7331 Intermodal Dr. \*\* Louisville \*\* KY 40258**

Tel: 502-933-8660; Fax: 502-933-3422; Sales: 800-336-1337; website: <http://www.vsholding.com>; e-mail: [info@vsholding.com](mailto:info@vsholding.com)