

**GJ01N60****N-CHANNEL ENHANCEMENT MODE POWER MOSFET**

BVDSS	600V
RDS(ON)	8Ω
ID	1.6A

**Description**

The GJ01N60 provide the designer with the best combination of fast switching.

The TO-252 package is universally preferred for all commercial-industrial surface mount applications and suited for AC/DC converters.

**Features**

- \*Dynamic dv/dt Rating
- \*Simple Drive Requirement
- \*Repetitive Avalanche Rated
- \*Fast Switching

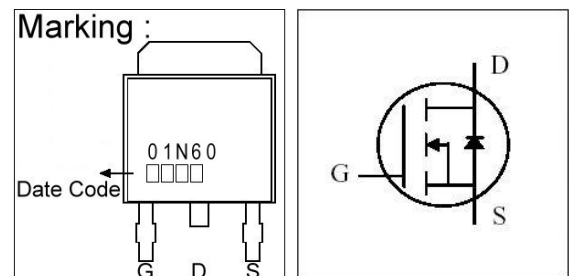
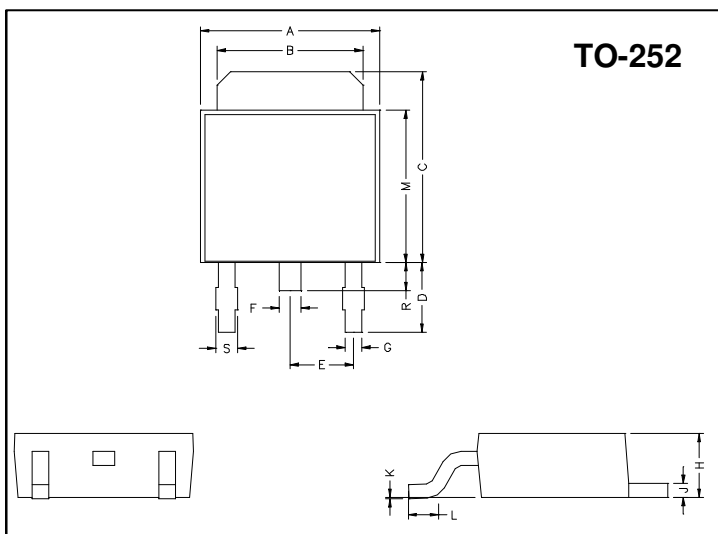
**Package Dimensions**

REF.	Millimeter		REF.	Millimeter	
	Min.	Max.		Min.	Max.
A	6.40	6.80	G	0.50	0.70
B	5.20	5.50	H	2.20	2.40
C	6.80	7.20	J	0.45	0.55
D	2.40	3.00	K	0	0.15
E	2.30 REF.		L	0.90	1.50
F	0.70	0.90	M	5.40	5.80
S	0.60	0.90	R	0.80	1.20

**Absolute Maximum Ratings**

Parameter	Symbol	Ratings	Unit
Drain-Source Voltage	$V_{DS}$	600	V
Gate-Source Voltage	$V_{GS}$	±20	V
Continuous Drain Current, $V_{GS}@10V$	$I_D @T_C=25^{\circ}C$	1.6	A
Continuous Drain Current, $V_{GS}@10V$	$I_D @T_C=100^{\circ}C$	1	A
Pulsed Drain Current <sup>1</sup>	$I_{DM}$	6	A
Total Power Dissipation	$P_D @T_C=25^{\circ}C$	39	W
Linear Derating Factor		0.31	W/°C
Single Pulse Avalanche Energy <sup>2</sup>	$E_{AS}$	13	mJ
Avalanche Current	$I_{AR}$	1.6	A
Repetitive Avalanche Energy	$E_{AR}$	0.5	mJ
Operating Junction and Storage Temperature Range	$T_j, T_{stg}$	-55 ~ +150	°C

**Thermal Data**

Parameter	Symbol	Value	Unit
Thermal Resistance Junction-case Max.	$R_{thj-c}$	3.2	°C/W
Thermal Resistance Junction-ambient Max.	$R_{thj-a}$	110	°C/W

**Electrical Characteristics (T<sub>j</sub> = 25°C unless otherwise specified)**

Parameter	Symbol	Min.	Typ.	Max.	Unit	Test Conditions
Drain-Source Breakdown Voltage	BV <sub>DSS</sub>	600	-	-	V	V <sub>GS</sub> =0, I <sub>D</sub> =250uA
Breakdown Voltage Temperature Coefficient	ΔBV <sub>DSS</sub> / ΔT <sub>j</sub>	-	0.6	-	V/°C	Reference to 25°C, I <sub>D</sub> =1mA
Gate Threshold Voltage	V <sub>GS(th)</sub>	2.0	-	4.0	V	V <sub>DS</sub> =V <sub>GS</sub> , I <sub>D</sub> =250uA
Forward Transconductance	g <sub>fs</sub>	-	0.8	-	S	V <sub>DS</sub> =50V, I <sub>D</sub> =0.8A
Gate-Source Leakage Current	I <sub>GSS</sub>	-	-	±100	nA	V <sub>GS</sub> = ±20V
Drain-Source Leakage Current(T <sub>j</sub> =25°C)	I <sub>DSS</sub>	-	-	100	uA	V <sub>DS</sub> =600V, V <sub>GS</sub> =0
Drain-Source Leakage Current(T <sub>j</sub> =150°C)		-	-	500	uA	V <sub>DS</sub> =480V, V <sub>GS</sub> =0
Static Drain-Source On-Resistance	R <sub>DS(ON)</sub>	-	7.2	8.0	Ω	V <sub>GS</sub> =10V, I <sub>D</sub> =0.8A
Total Gate Charge <sup>3</sup>	Q <sub>g</sub>	-	7.7	-	nC	I <sub>D</sub> =1.6A V <sub>DS</sub> =480V V <sub>GS</sub> =10V
Gate-Source Charge	Q <sub>gs</sub>	-	1.5	-		
Gate-Drain ("Miller") Change	Q <sub>gd</sub>	-	2.6	-		
Turn-on Delay Time <sup>3</sup>	T <sub>d(on)</sub>	-	8	-	ns	V <sub>DD</sub> =300V I <sub>D</sub> =1.6A V <sub>GS</sub> =10V R <sub>G</sub> =10Ω R <sub>D</sub> =187.5Ω
Rise Time	T <sub>r</sub>	-	5	-		
Turn-off Delay Time	T <sub>d(off)</sub>	-	14	-		
Fall Time	T <sub>f</sub>	-	7	-		
Input Capacitance	C <sub>iss</sub>	-	286	-	pF	V <sub>GS</sub> =0V V <sub>DS</sub> =25V f=1.0MHz
Output Capacitance	C <sub>oss</sub>	-	25	-		
Reverse Transfer Capacitance	C <sub>rss</sub>	-	5	-		

**Source-Drain Diode**

Parameter	Symbol	Min.	Typ.	Max.	Unit	Test Conditions
Forward On Voltage <sup>3</sup>	V <sub>SD</sub>	-	-	1.5	V	I <sub>S</sub> =1.6A, V <sub>GS</sub> =0V, T <sub>j</sub> =25°C
Continuous Source Current (Body Diode)	I <sub>S</sub>	-	-	1.6	A	V <sub>D</sub> = V <sub>G</sub> =0V, V <sub>S</sub> =1.5V
Pulsed Source Current (Body Diode) <sup>1</sup>	I <sub>SM</sub>	-	-	6	A	

Notes: 1. Pulse width limited by safe operating area.

2. Staring T<sub>j</sub>=25°C, V<sub>DD</sub>=50V, L=10mH, R<sub>G</sub>=25Ω, I<sub>AS</sub>=1.6A.

3. Pulse width ≤ 300us, duty cycle ≤ 2%.

## Characteristics Curve

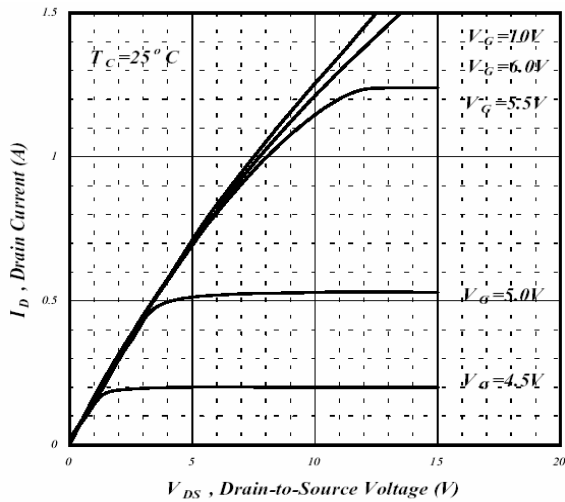

**Fig 1. Typical Output Characteristics**

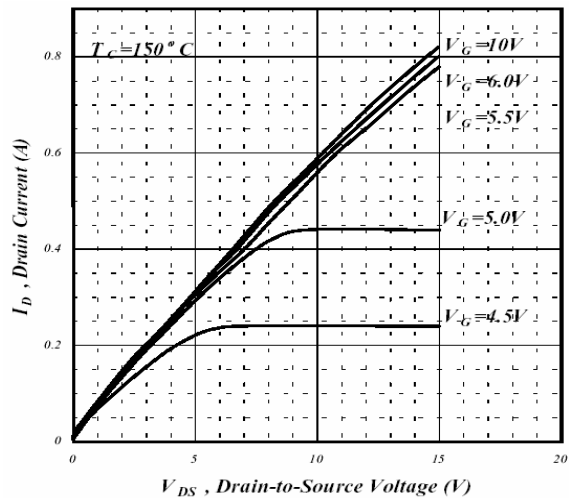

**Fig 2. Typical Output Characteristics**

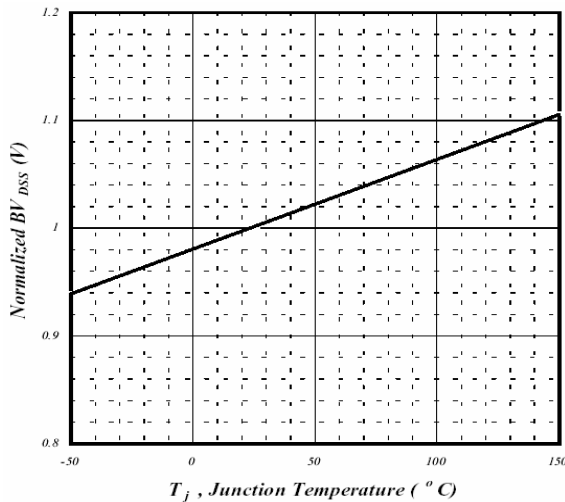

**Fig 3. Normalized  $BV_{DSS}$  v.s. Junction Temperature**

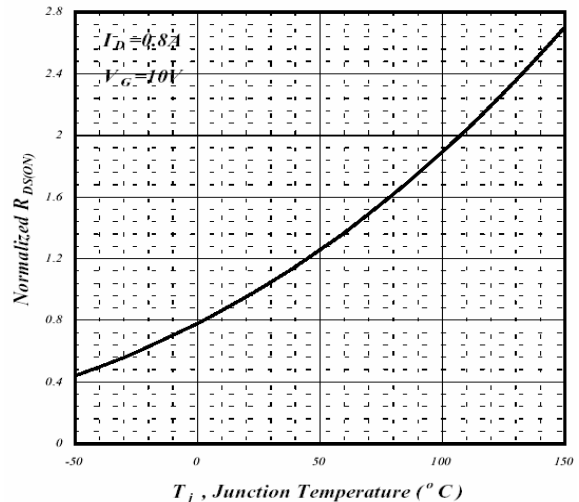

**Fig 4. Normalized On-Resistance v.s. Junction Temperature**

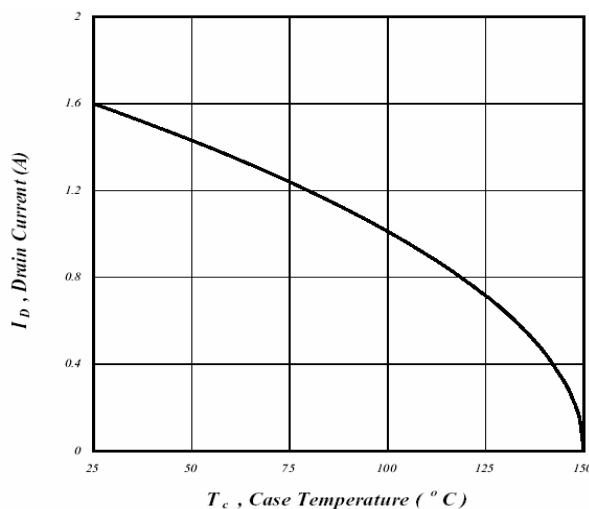

**Fig 5. Maximum Drain Current v.s. Case Temperature**

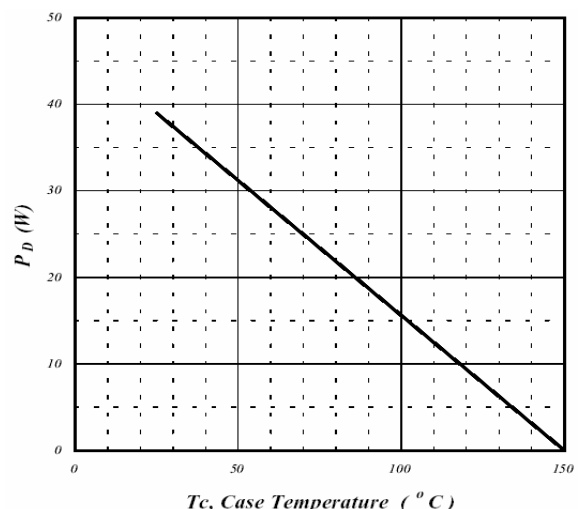

**Fig 6. Type Power Dissipation**

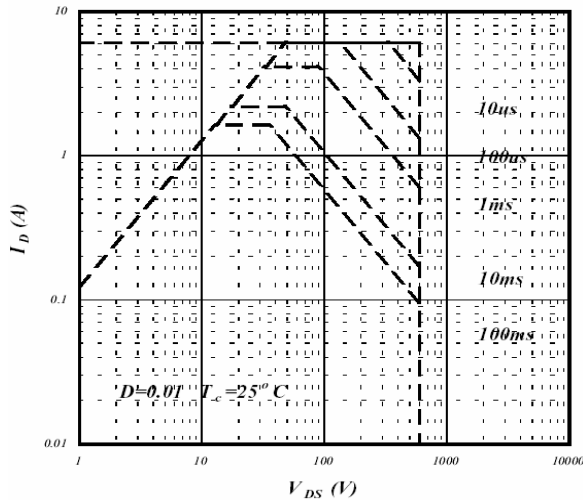

**Fig 7. Maximum Safe Operating Area**

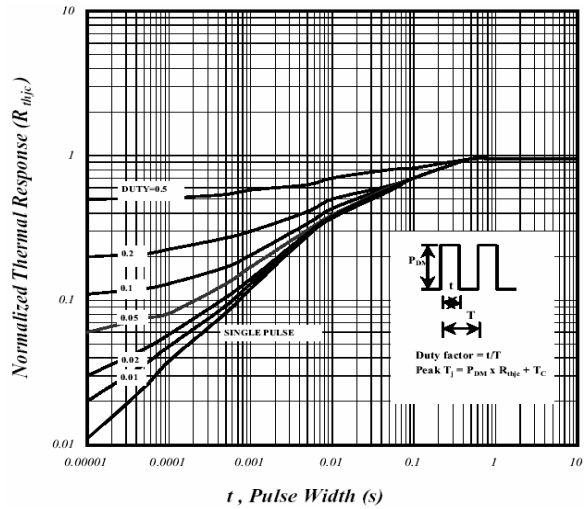

**Fig 8. Effective Transient Thermal Impedance**

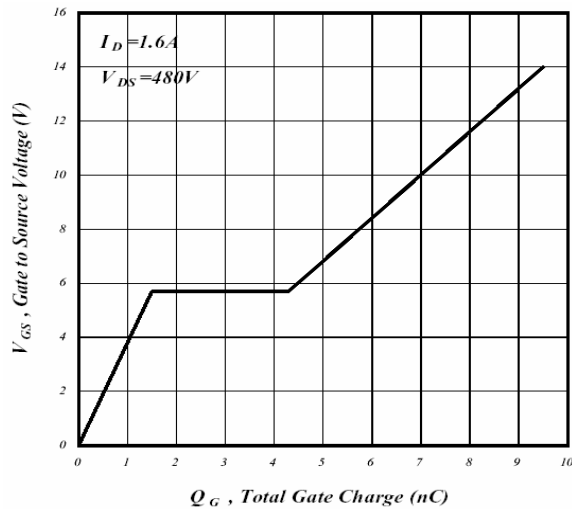

**Fig 9. Gate Charge Characteristics**

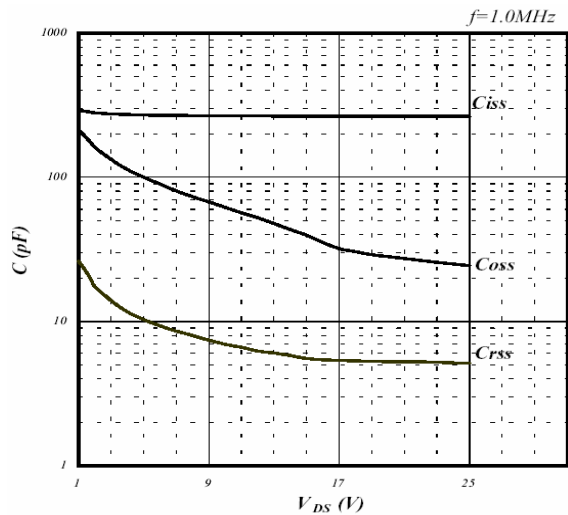

**Fig 10. Typical Capacitance Characteristics**

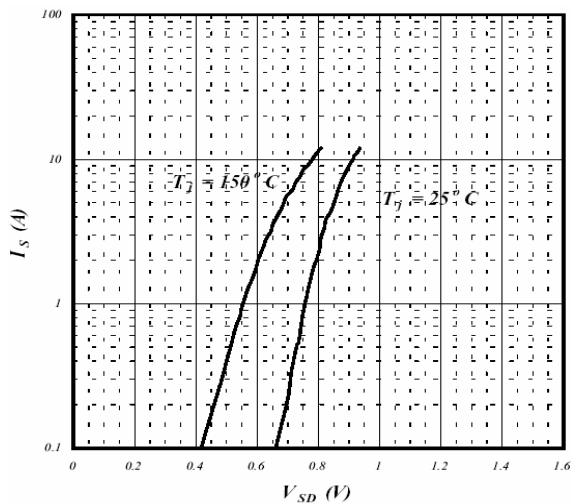

**Fig 11. Forward Characteristics of Reverse Diode**

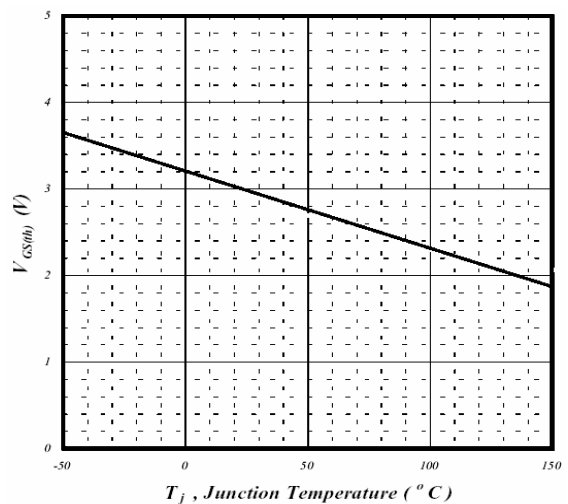

**Fig 12. Gate Threshold Voltage v.s. Junction Temperature**

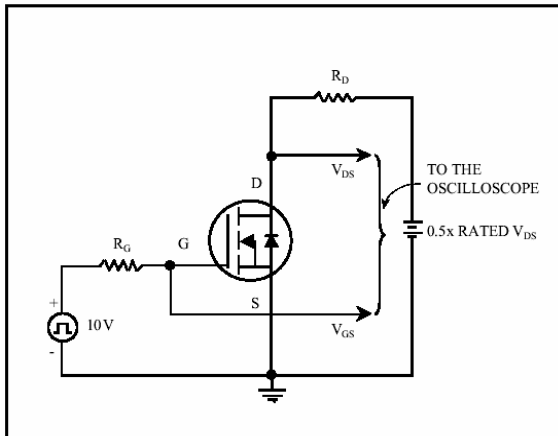

**Fig 13. Switching Time Circuit**

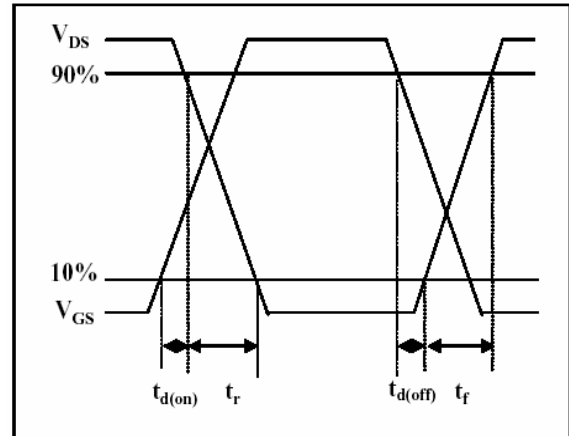

**Fig 14. Switching Time Waveform**

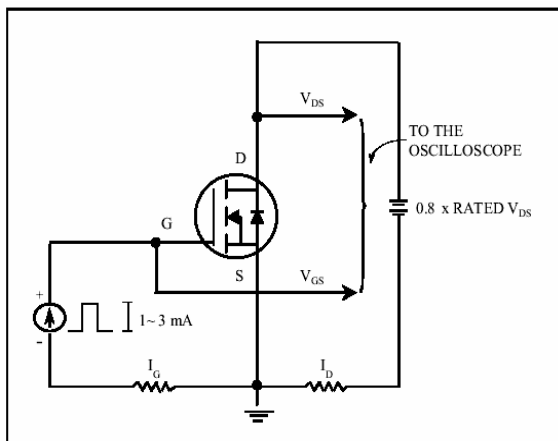

**Fig 15. Gate Charge Circuit**

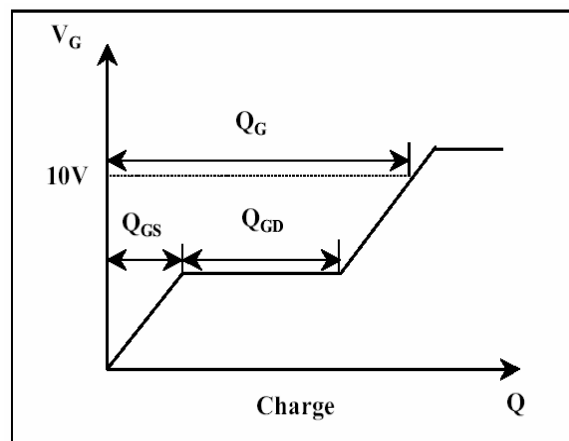

**Fig 16. Gate Charge Waveform**

**Important Notice:**

- All rights are reserved. Reproduction in whole or in part is prohibited without the prior written approval of GTM.
- GTM reserves the right to make changes to its products without notice.
- GTM semiconductor products are not warranted to be suitable for use in life-support Applications, or systems.
- GTM assumes no liability for any consequence of customer product design, infringement of patents, or application assistance.

**Head Office And Factory:**

- **Taiwan:** No. 17-1 Tatung Rd. Fu Kou Hsin-Chu Industrial Park, Hsin-Chu, Taiwan, R. O. C.
- TEL : 886-3-597-7061 FAX : 886-3-597-9220, 597-0785
- **China:** (201203) No.255, Jang-Jiang Tsai-Lueng RD. , Pu-Dung-Hsin District, Shang-Hai City, China
- TEL : 86-21-5895-7671 ~ 4 FAX : 86-21-38950165