

# MINIATURE SIGNAL RELAY ED2/EF2 SERIES

Ultra-low power, compact and lightweight, High breakdown voltage,  
Surface mounting type

## DESCRIPTION

NEC's new miniature signal relays, ED2/EF2 series, achieved 50 mW of ultra low power consumption.

## FEATURES

- Low power consumption (50 mW)
- Applicable for the surge voltage standard of FCC (1500 V,  $10 \times 160 \mu\text{s}$ ) and BELLCORE (2500 V,  $2 \times 10 \mu\text{s}$ )
- Two types for through-hole mounting (ED2 series) and surface mounting (EF2 series)
- Variation of dense mounting type and/or long-joint-life type for latest SMT
  - Compatible configuration and terminal allocation with dense mounting type of EE2 series
  - Upgraded soldering joint reliability between the relay terminal and PCB by optimization of the terminal configuration;  
20-year-joint-life under 35°C-per-day-temperature-difference specified in IPC-SM-785 for telecommunication equipment

## APPLICATIONS

Electronic switching systems, PBX, terminal equipment, telephone system, instrumental equipment.

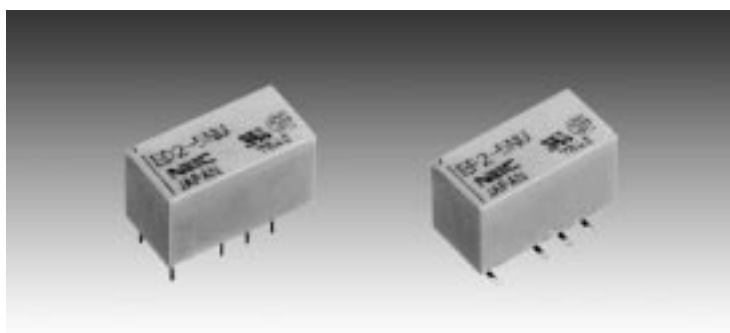

### For Right Use of Miniature Relays

#### DO NOT EXCEED MAXIMUM RATINGS.

Do not use relays under exceeding conditions such as over ambient temperature, over voltage and over current. Incorrect use could result in abnormal heating, damage to related parts or cause burning.

#### READ CAUTIONS IN THE SELECTION GUIDE.

Read the cautions described in NEC's "Miniature Relays" (ER0046EJ\*) when you choose relays for your application.

The information in this document is subject to change without notice.

DIMENSIONS AND PAD LAYOUTS (Unit : mm (inch))

ED2 SERIES

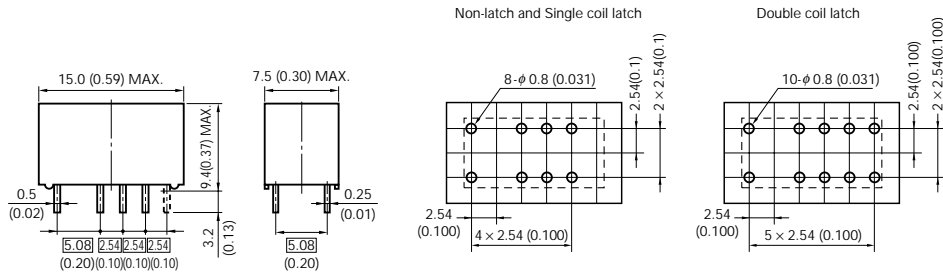

Note. General tolerance :  $\pm 0.2$  ( $\pm 0.008$ )  
 Dimensions in    show basic size.  
 NJ type : Leads-2.8 mm (0.110)

Note. General tolerance :  $\pm 0.1$  ( $\pm 0.004$ )

EF2 SERIES

EF2-...  
 EF2-...NU

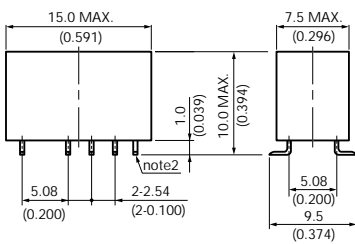

EF2-...NUX

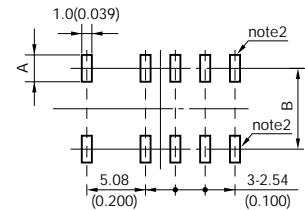
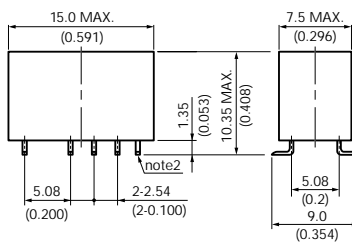

(Bottom view)

EF2-...NUH

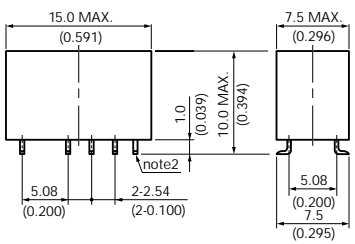

EF2-...NUN

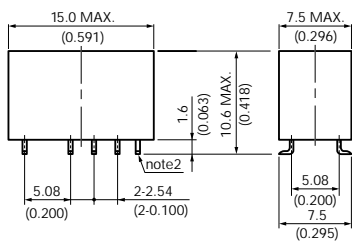

Type	A	B
EF2-...	3.0 (0.118)	7.29 (0.287)
EF2-...NU	3.0 (0.118)	7.29 (0.287)
EF2-...NUX	2.73 (0.107)	7.02 (0.276)
EF2-...NUH	2.0 (0.079)	6.29 (0.248)
EF2-...NUN	2.0 (0.079)	6.29 (0.248)

Note 1. General tolerance :  $\pm 0.2$  ( $\pm 0.008$ )  
 Note 2. This pair of pins at the right end applies to double coil latch type only.

Note 1. General tolerance :  $\pm 0.1$  ( $\pm 0.004$ )  
 Note 2. This pair of pads at the right end applies to double coil latch type only.

PIN CONFIGURATIONS (bottom view)

ED2 SERIES

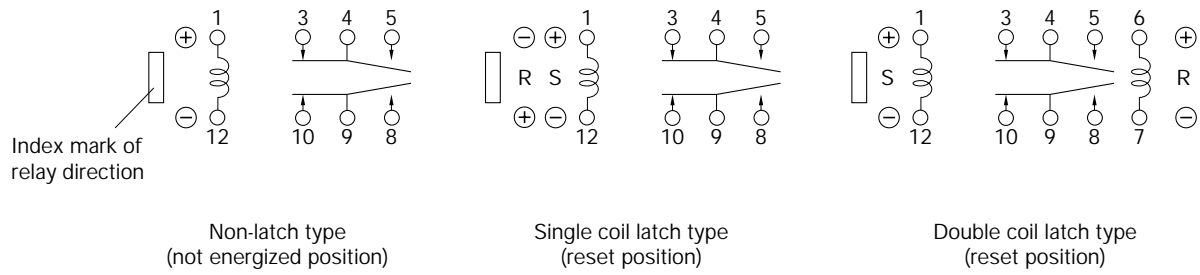

S : Coil polarity of set (operate)  
R : Coil polarity of reset (release)

EF2 SERIES

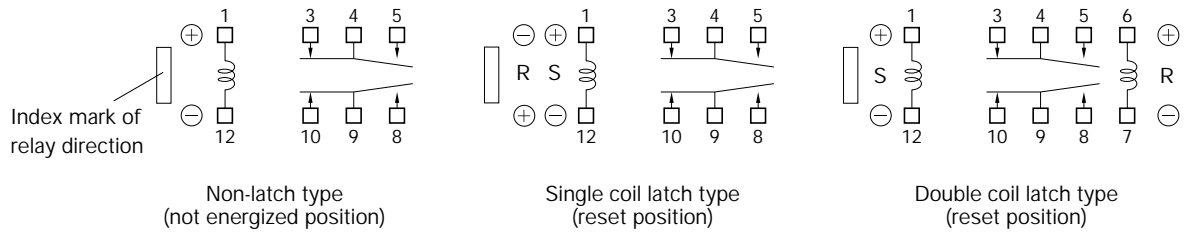

S : Coil polarity of set (operate)  
R : Coil polarity of reset (release)

MARKINGS (top view)

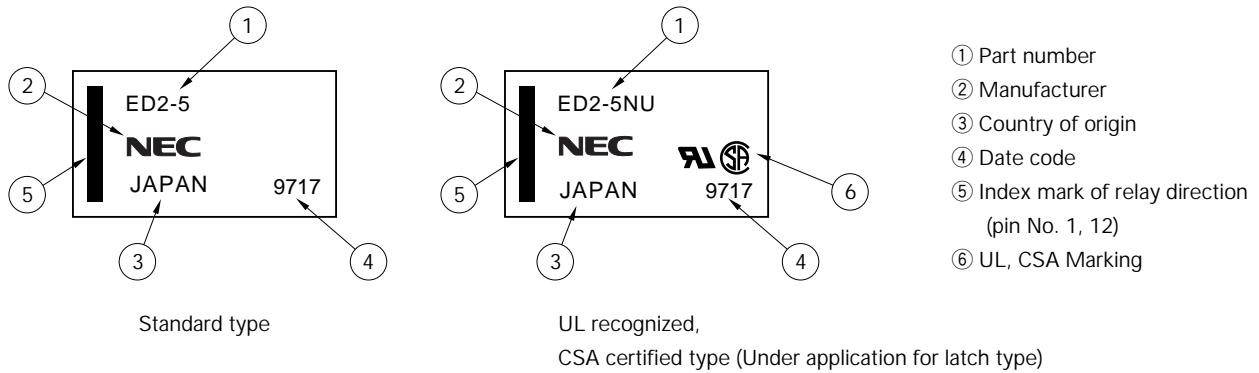

SAFETY STANDARD AND RATING

UL Recognized (UL508)* File No E73266	CSA Certified (CSA C22.2 No14) File No LR46266
30 Vdc, 1 A (Resistive) 110 Vdc, 0.3 A (Resistive) 125 Vac, 0.5 A (Resistive)	

\* Spacing : UL114, UL478

PERFORMANCE CHARACTERISTICS (Community)

Contact Form		2 Form c	
Contact Ratings	Maximum Switching Power	30 W (resistive)	62.5 VA (resistive)
	Maximum Switching Voltage	220 Vdc	250 Vac
	Maximum Switching Current	1 A	
	Maximum Carrying Current	2 A	
Minimum Contact Ratings		10 mV.dc, 10 $\mu$ A *4	
Initial Contact Resistance		50 m $\Omega$ typ. (Initial)	
Contact Material		Silver alloy with gold alloy overlay	
Nominal Operating Power	Non-Latch Type	50 to 70 mW	
	Single Coil Latch Type	30 to 80 mW	
	Double Latch Type	50 to 80 mW	
Operate Time (Excluding Bounce)		Approximately 3 ms	
Release Time (Excluding Bounce)		Approximately 2 ms without diode	
Insulation Resistance		1000 M $\Omega$ at 500 Vdc	
Breakdown Voltage	Between Open Contacts	1000 Vac for one minute (1500 V surge, 10 $\times$ 160 $\mu$ s *1)	
	Between Adjacent Contacts		
	Between Coil and Contact	Non-latch type and single-coil latch type 1500 Vac for one minute (2500 V surge, 2 $\times$ 10 $\mu$ s *2) Double-coil latch type 1000 Vac for one minute (1500 V surge, 10 $\times$ 160 $\mu$ s *1)	
Shock Resistance		735 m / s <sup>2</sup> (75 G) (misoperating) 980 m / s <sup>2</sup> (100 G) (destructive failure)	
Vibration Resistance		10 to 55 Hz at double amplitude of 3 mm (20 G) (misoperating) 10 to 55 Hz, double amplitude of 5 mm (30 G) (Destructive failure)	
Ambient Temperature		Non-latch type (Additional "N"): -40 to +85°C	
		Non-latch type (Standard): -40 to +70°C	
		Latch type : -40 to +70°C	
Coil Temperature Rise		7 degrees at nominal coil voltage (50 mW)	
Running specifications	No-load	1 $\times$ 10 <sup>8</sup> *3 operations (Non-latch type)	
		1 $\times$ 10 <sup>7</sup> operations (Latch type)	
	Load	50 Vdc 0.1 A (resistive), 1 $\times$ 10 <sup>6</sup> operations at 70°C	
		10 Vdc 10 mA (resistive), 1 $\times$ 10 <sup>6</sup> operations at 70°C	
Weight		Approximately 2.2 grams	

\*1 rise time : 10  $\mu$ s, fall time : 160  $\mu$ s

\*2 rise time : 2  $\mu$ s, fall time : 10  $\mu$ s

\*3 This shows a number of operation where it can be running by which a fatal is not caused, and number of operation by which a steady characteristic is maintained is 1  $\times$  10<sup>7</sup> times.

\*4 This value is a reference value in the resistive load.

Minimum capacity changes depending on switching frequency and environment temperature and the load.

PART NUMBER SYSTEM

**ED2 - 9 S NU**

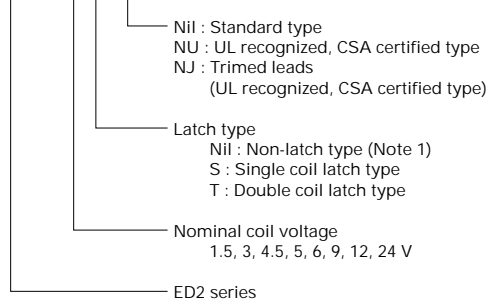

**EF2 - 5 S NUH**

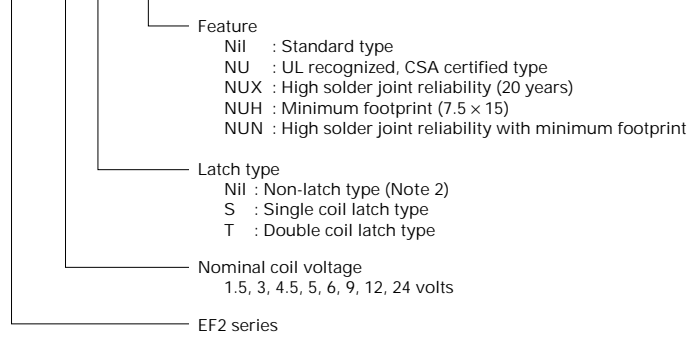

(UL, CSA : Under application for latch type)

Note 1. There are two specification in operate voltage of Non-latch type relay.

	Part Number	Must Operate Voltage
Additional "N" type	ED2-*NU	75%
	-*NJ	
Standard type	ED2-*	80%

\* : Nominal coil voltage

Note 2. There are two specification in operate voltage of Non-latch type relay.

	Part Number	Must Operate Voltage
Additional "N" type	ED2-*NU	75%
	-*NUX	
	-*NUH	
	-*NUN	
Standard type	EF2-*	80%

\* : Nominal coil voltage

NOMINAL LINEUP (Community)

Non-latch Type (Standard)

at 20°C

Nominal Coil Voltage (Vdc)	Coil Resistance ( $\Omega$ ) $\pm 10\%$	Must Operate Voltage (Vdc)	Must Release Voltage (Vdc)	Nominal operate power (mW)
1.5	45	1.2	0.15	50
3	180	2.4	0.3	50
4.5	405	3.6	0.45	50
5	500	4	0.5	50
6	720	4.8	0.6	50
9	1473	7.2	0.9	55
12	2400	9.6	1.2	60
24	8229	19.2	2.4	70

Non-latch Type (Additional "N")

at 20°C

Nominal Coil Voltage (Vdc)	Coil Resistance ( $\Omega$ ) $\pm 10\%$	Must Operate Voltage (Vdc)	Must Release Voltage (Vdc)	Nominal operate power (mW)
1.5	45	1.13	0.15	50
3	180	2.25	0.3	50
4.5	405	3.38	0.45	50
5	500	3.75	0.5	50
6	720	4.5	0.6	50
9	1473	6.75	0.9	55
12	2400	9	1.2	60
24	8229	18	2.4	70

Single-Coil Latch Type

at 20°C

Nominal Coil Voltage (Vdc)	Coil Resistance ( $\Omega$ ) $\pm 10\%$	Must Operate Voltage (Vdc)	Must Release Voltage (Vdc)	Nominal operate power (mW)
1.5	75	1.2	1.2	30
3	300	2.4	2.4	30
4.5	675	3.6	3.6	30
5	833	4	4	30
6	1200	4.8	4.8	30
9	2700	7.2	7.2	30
12	4800	9.6	9.6	30
24	7200	19.2	19.2	80

Double-Coil Latch Type

at 20°C

Nominal Coil Voltage (Vdc)	Coil Resistance ( $\Omega$ ) $\pm 10\%$		Must Operate Voltage (Vdc)	Must Release Voltage (Vdc)	Nominal operate power (mW)
	S	R			
1.5	S	45	1.2	-	50
	R	45	-	1.2	
3	S	180	2.4	-	50
	R	180	-	2.4	
4.5	S	405	3.6	-	50
	R	405	-	3.6	
5	S	500	4	-	50
	R	500	-	4	
6	S	720	4.8	-	50
	R	720	-	4.8	
9	S	1620	7.2	-	50
	R	1620	-	7.2	
12	S	2880	9.6	-	50
	R	2880	-	9.6	
24	S	7200	19.2	-	80
	R	7200	-	19.2	

Recommended coil voltage with ambient temperature

Non latch typ (Additional "N")

Latch typ

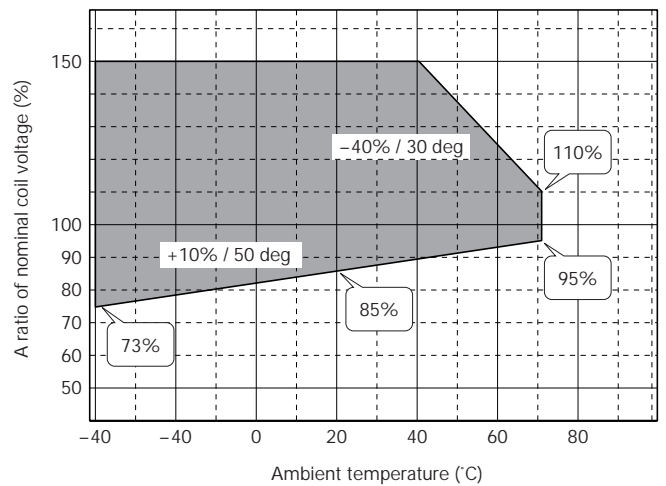
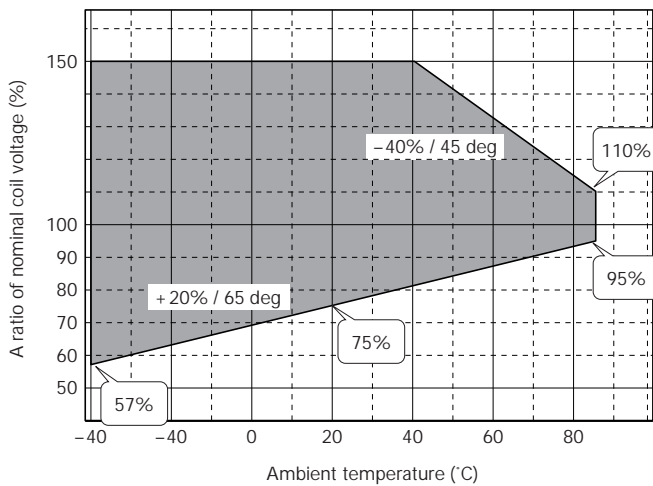

TYPICAL PERFORMANCE DATA

● Coil Temperature Rise

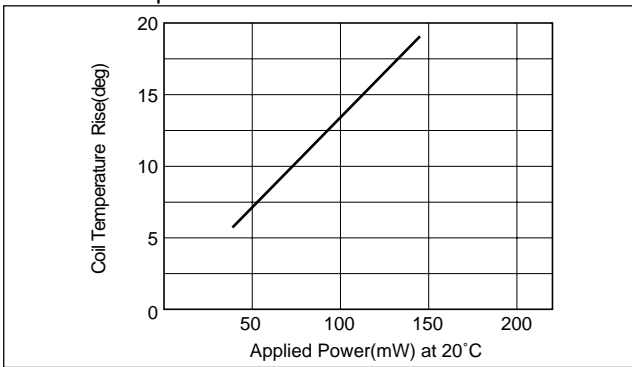

● Breakdown Voltage

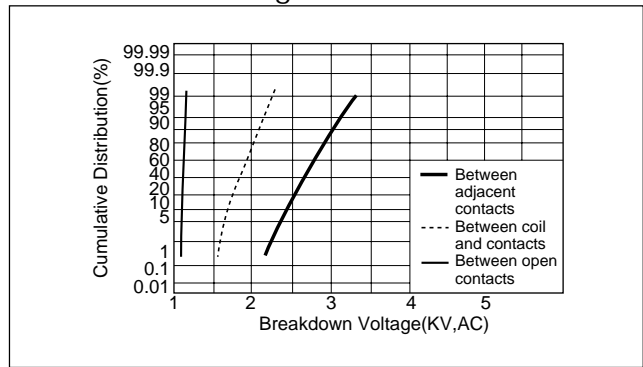

● Operate Time

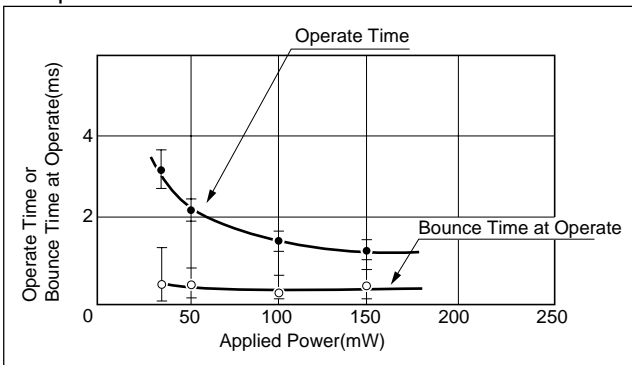

● Release Time without diode

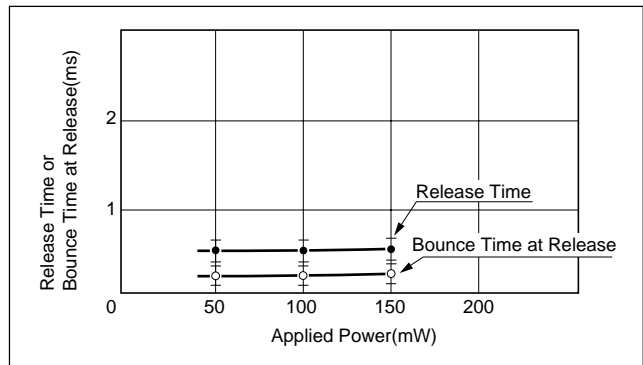

● Contact Resistance

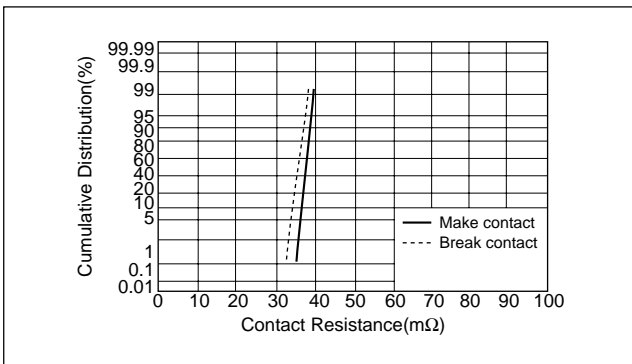

● Release Time with diode

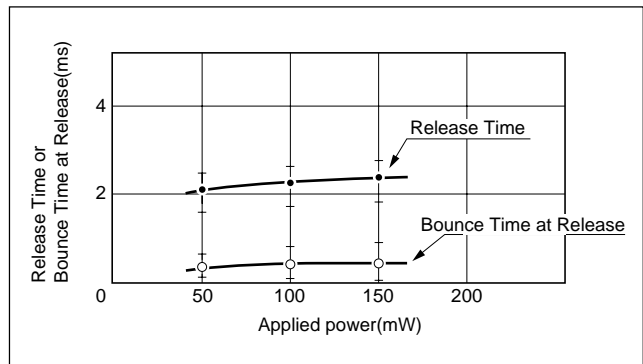

● Switching Capacity

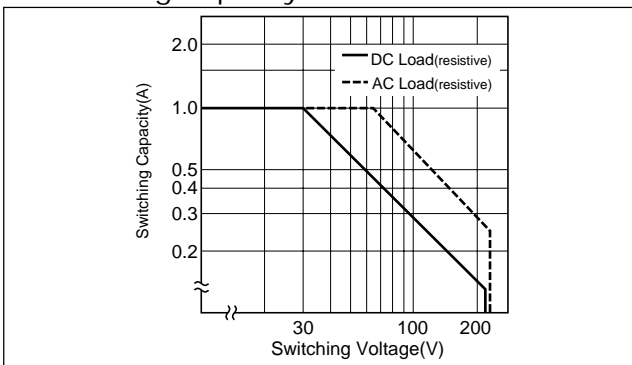

● Transfer Time

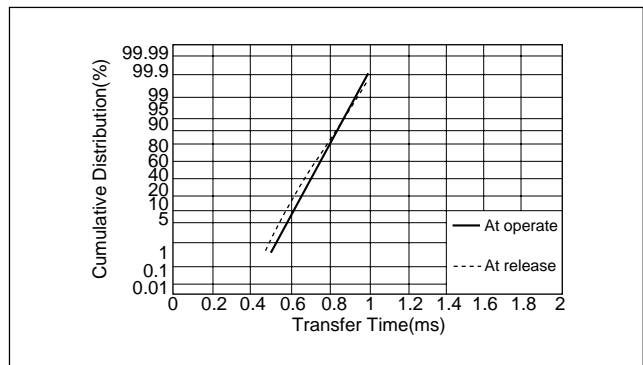



● Magnetic Interference (ED2 Relay)

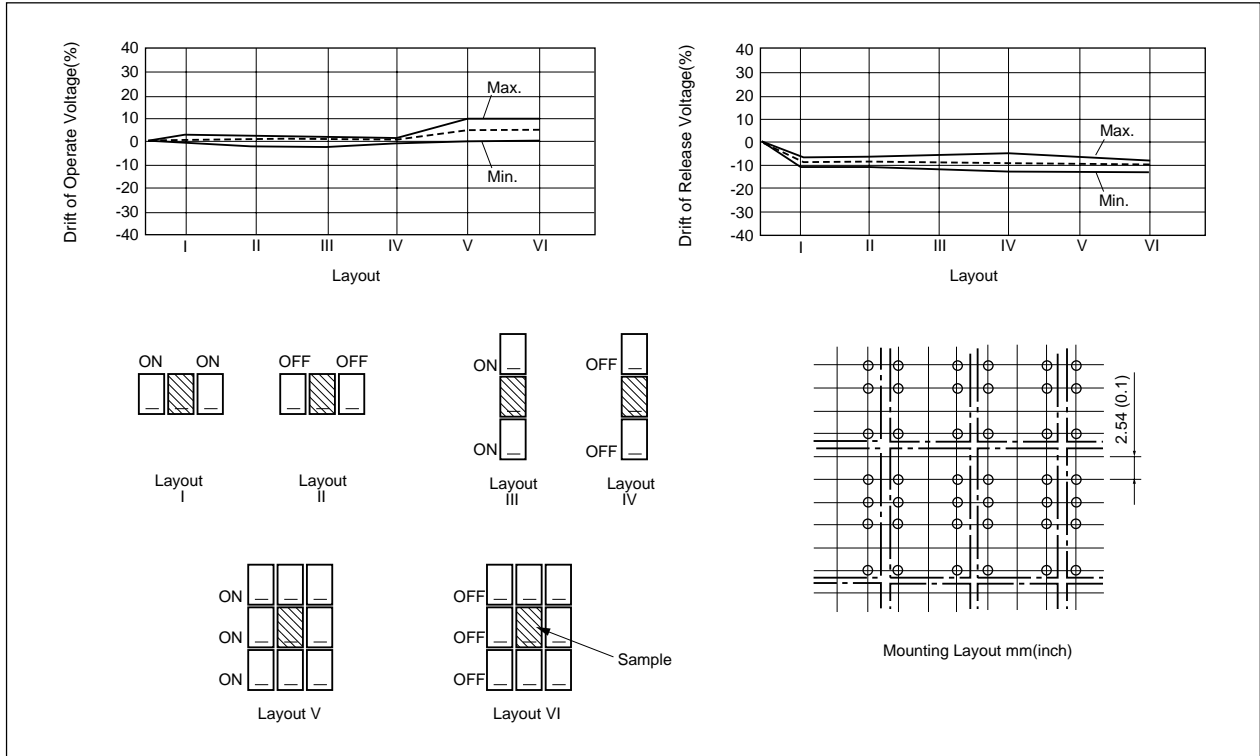

● Mechanical Life

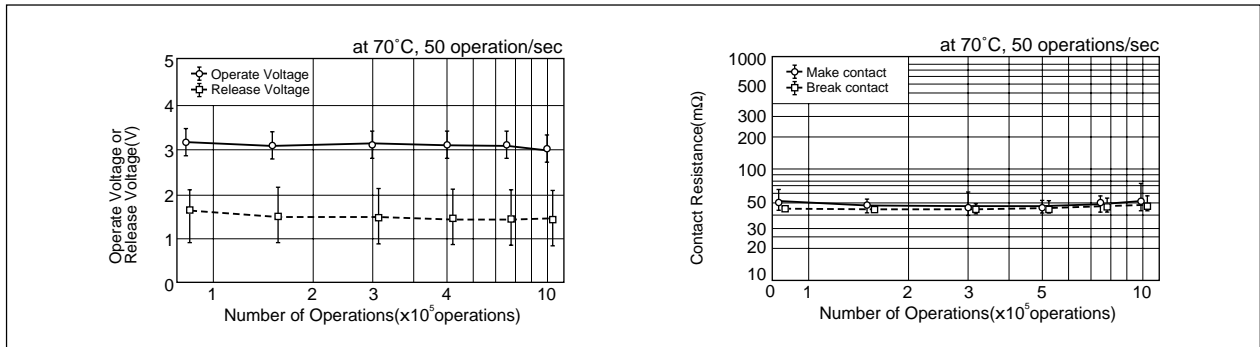

TUBE PACKAGE (ED2, EF2)

Dimension of Package (Unit : mm)

35 pieces / Tube  
Material : Polyvinyl chloride  
(anti-static treated)

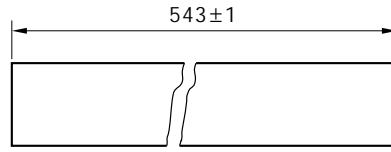
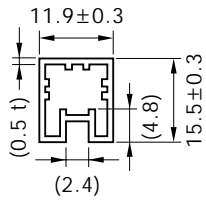

( ) Reference

Outline of Package

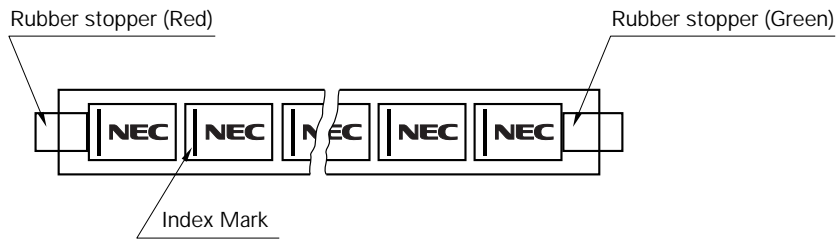

TAPE PACKAGE (EF2)

APPEARANCE

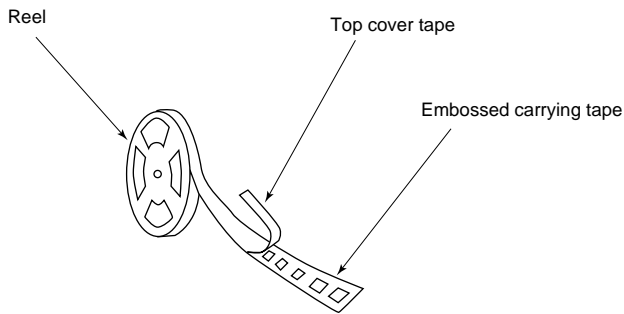

TAPE DIMENSION mm (inch)

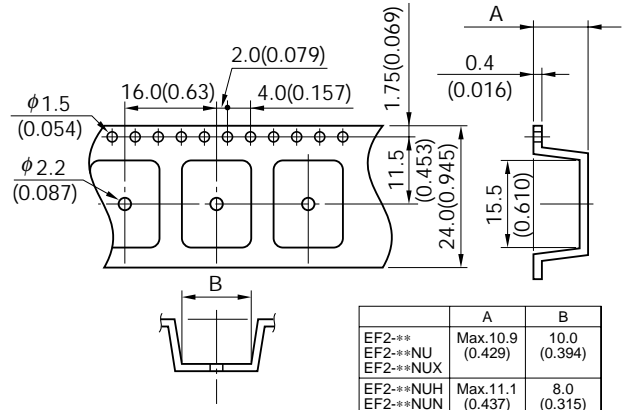

Relay orientation mark and tape carrying direction.

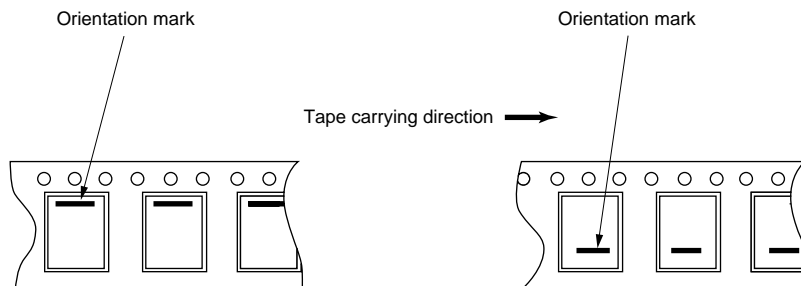

Carrying tape type L  
Part number EF2-\*\*\*-L

R  
EF2-\*\*\*-R

SOLDERING TEMPERATURE CONDITION

Through-hole mounting type (ED2)

- ① Automatic soldering
  - \* Preheating : 100°C max. 1 minute max.
  - \* Solder temperature : 250°C max.
  - \* Solder time : 10 seconds max.
- ② Manual soldering
  - \* Solder temperature : 350°C max.
  - \* Solder time : 3 seconds max.

Surface mounting type (EF2)

IRS Method

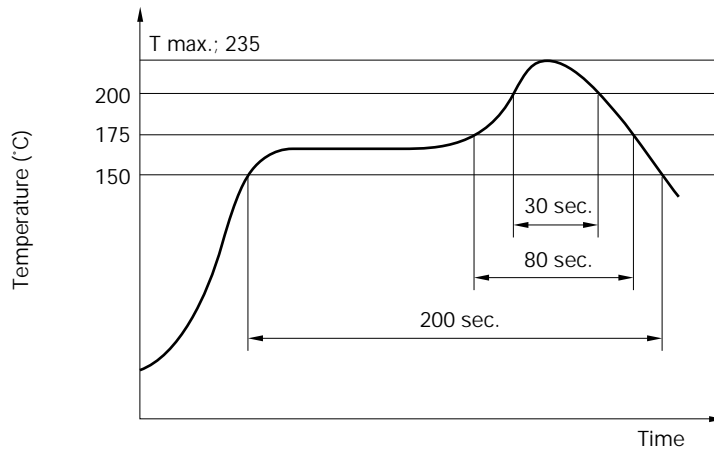

VPS Method

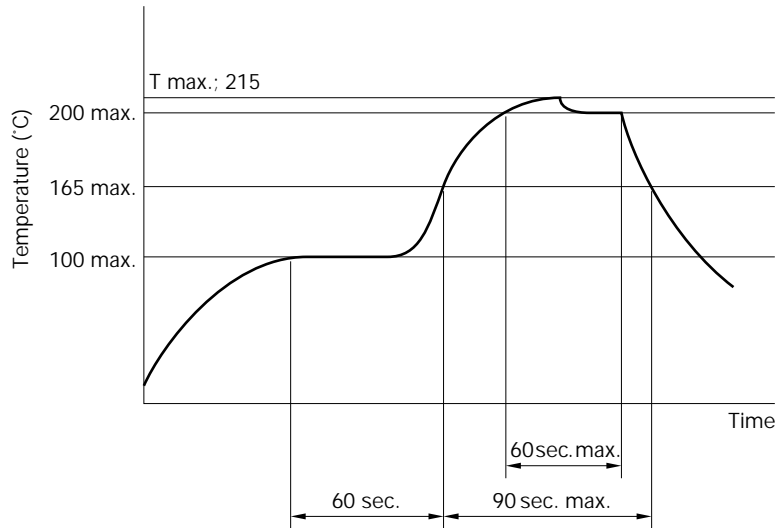

Note:

1. Temperature profile shows printed circuit board surface temperature on the relay terminal portion.
2. Check the actual soldering condition to use other method except above mentioned temperature profiles.

## GUIDE TO APPLICATIONS

1. When connecting coils, refer to the pin configuration to prevent misoperation or malfunction.
2. The latch type relay should be initialized at the appointed position (set or reset position) when using, and should be energized or deenergized to the specified polarity to avoid wrong operations by reversed contact state.
3. Ultrasonic cleaning is not recommended to keep contact performance reliable. Alcohol based solvents are available as proper solvents.
4. Pressurized stress on the relay cover may affect reliable operation.
5. Minimum contact load of the relay is 10 mVdc, 10  $\mu$ A.  
This value is a reference value in the resistance load.  
Minimum capacity changes depending on switching frequency and environment temperature and the load.







No part of this document may be copied or reproduced in any form or by any means without the prior written consent of NEC Corporation. NEC Corporation assumes no responsibility for any errors which may appear in this document.

NEC Corporation does not assume any liability for infringement of patents, copyrights or other intellectual property rights of third parties by or arising from use of a device described herein or any other liability arising from use of such device. No license, either express, implied or otherwise, is granted under any patents, copyrights or other intellectual property rights of NEC Corporation or others.

While NEC Corporation has been making continuous effort to enhance the reliability of its electronic components, the possibility of defects cannot be eliminated entirely. To minimize risks of damage or injury to persons or property arising from a defect in an NEC electronic component, customers must incorporate sufficient safety measures in its design, such as redundancy, fire-containment, and anti-failure features.

NEC devices are classified into the following three quality grades:

"Standard", "Special", and "Specific". The Specific quality grade applies only to devices developed based on a customer designated "quality assurance program" for a specific application. The recommended applications of a device depend on its quality grade, as indicated below. Customers must check the quality grade of each device before using it in a particular application.

Standard: Computers, office equipment, communications equipment, test and measurement equipment, audio and visual equipment, home electronic appliances, machine tools, personal electronic equipment and industrial robots

Special: Transportation equipment (automobiles, trains, ships, etc.), traffic control systems, anti-disaster systems, anti-crime systems, safety equipment and medical equipment (not specifically designed for life support)

Specific: Aircrafts, aerospace equipment, submersible repeaters, nuclear reactor control systems, life support systems or medical equipment for life support, etc.

The quality grade of NEC devices is "Standard" unless otherwise specified in NEC's Data Sheets or Data Books. If customers intend to use NEC devices for applications other than those specified for Standard quality grade, they should contact an NEC sales representative in advance.

Anti-radioactive design is not implemented in this product.