



## ST2310DHI

### HIGH VOLTAGE FAST-SWITCHING NPN POWER TRANSISTOR

- NEW SERIES, ENHANCED PERFORMANCE
- FULLY INSULATED PACKAGE (U.L. COMPLIANT) FOR EASY MOUNTING
- INTEGRATED FREE WHEELING DIODE
- HIGH VOLTAGE CAPABILITY (> 1500 V)
- HIGH SWITCHING SPEED
- TIGHTER  $h_{fe}$  CONTROL
- IMPROVED RUGGEDNESS

#### APPLICATIONS:

- HORIZONTAL DEFLECTION HIGH END TVS

#### DESCRIPTION

The device is manufactured using Diffused Collector technology for more stable operation Vs base drive circuit variations resulting in very low worst case dissipation.

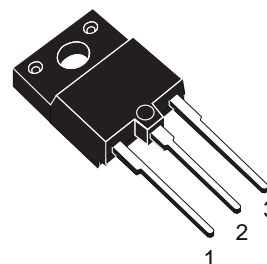

ISOWATT218

#### INTERNAL SCHEMATIC DIAGRAM

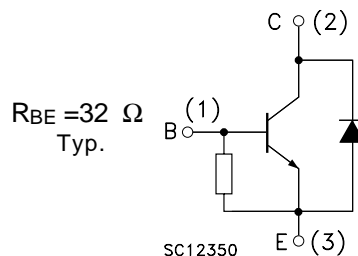

#### ABSOLUTE MAXIMUM RATINGS

Symbol	Parameter	Value	Unit
$V_{CES}$	Collector-Emitter Voltage ( $V_{BE} = 0$ )	1500	V
$V_{CEO}$	Collector-Emitter Voltage ( $I_B = 0$ )	600	V
$V_{EBO}$	Emitter-Base Voltage ( $I_C = 0$ )	7	V
$I_C$	Collector Current	12	A
$I_{CM}$	Collector Peak Current ( $t_p < 5$ ms)	25	A
$I_B$	Base Current	7	A
$P_{tot}$	Total Dissipation at $T_c = 25$ °C	55	W
$V_{isol}$	Insulation Withstand Voltage (RMS) from All Three Leads to External Heatsink	2500	V
$T_{stg}$	Storage Temperature	-65 to 150	°C
$T_j$	Max. Operating Junction Temperature	150	°C

# ST2310DHI

## THERMAL DATA

R <sub>thj-case</sub>	Thermal Resistance Junction-case	Max	2.3	°C/W
-----------------------	----------------------------------	-----	-----	------

## ELECTRICAL CHARACTERISTICS (T<sub>case</sub> = 25 °C unless otherwise specified)

Symbol	Parameter	Test Conditions	Min.	Typ.	Max.	Unit
I <sub>CES</sub>	Collector Cut-off Current (V <sub>BE</sub> = 0)	V <sub>CE</sub> = 1500 V V <sub>CE</sub> = 1500 V T <sub>J</sub> = 125 °C			1 2	mA mA
I <sub>EBO</sub>	Emitter Cut-off Current (I <sub>C</sub> = 0)	V <sub>EB</sub> = 4 V	70		210	mA
V <sub>(BR)EBO</sub>	Emitter-Base Breakdown Voltage (I <sub>C</sub> = 0)	I <sub>E</sub> = 800 mA	7			V
V <sub>CE(sat)*</sub>	Collector-Emitter Saturation Voltage	I <sub>C</sub> = 7 A I <sub>B</sub> = 1.75 A			3	V
V <sub>BE(sat)*</sub>	Base-Emitter Saturation Voltage	I <sub>C</sub> = 7 A I <sub>B</sub> = 1.75 A			1.1	V
h <sub>FE*</sub>	DC Current Gain	I <sub>C</sub> = 1 A V <sub>CE</sub> = 5 V I <sub>C</sub> = 7 A V <sub>CE</sub> = 1 V I <sub>C</sub> = 7 A V <sub>CE</sub> = 5 V	5.5	15 5	8.5	
t <sub>s</sub> t <sub>f</sub>	INDUCTIVE LOAD Storage Time Fall Time	I <sub>C</sub> = 5 A f = 32 KHz I <sub>B(on)</sub> = 0.9 A V <sub>BE(off)</sub> = -2.5 V L <sub>BB(off)</sub> = 1.9 μH (see figure 1)		2 0.25	2.5 0.5	μs μs
V <sub>f</sub>	Diode Forward Voltage	I <sub>C</sub> = 7 A		1.5	2.2	V

\* Pulsed: Pulse duration = 300 μs, duty cycle 1.5 %

## Safe Operating Area

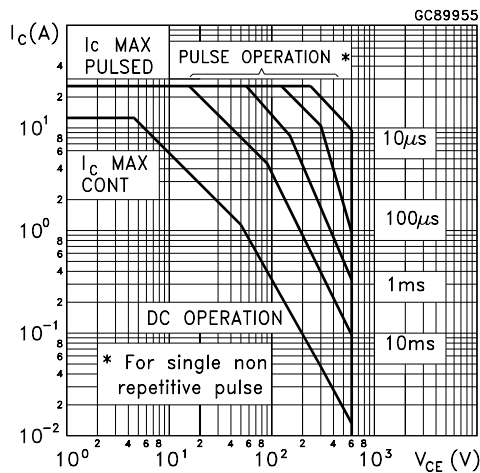

## Thermal Impedance

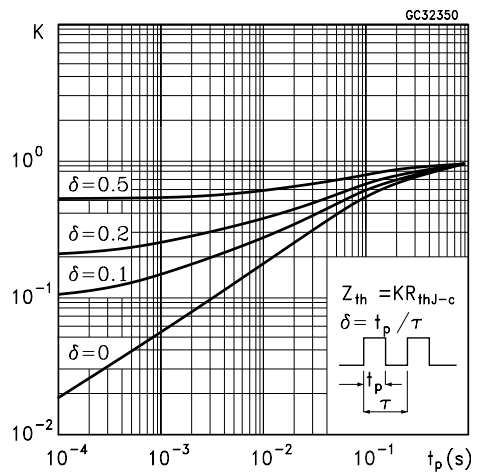

Derating Curve

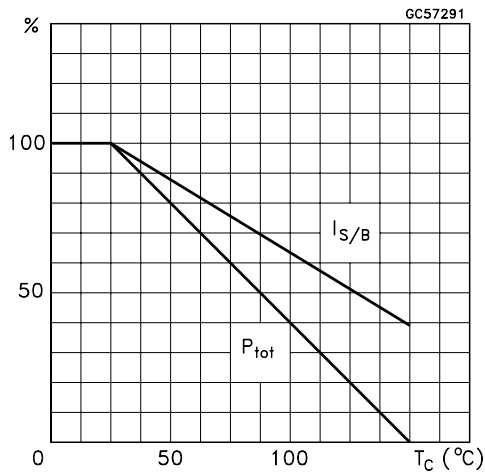

Output Characteristics

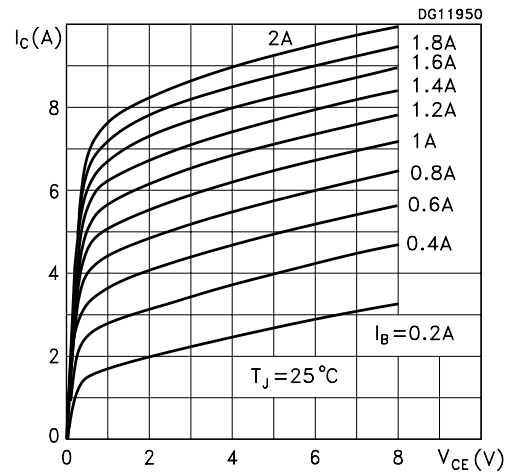

Collector Emitter Saturation Voltage

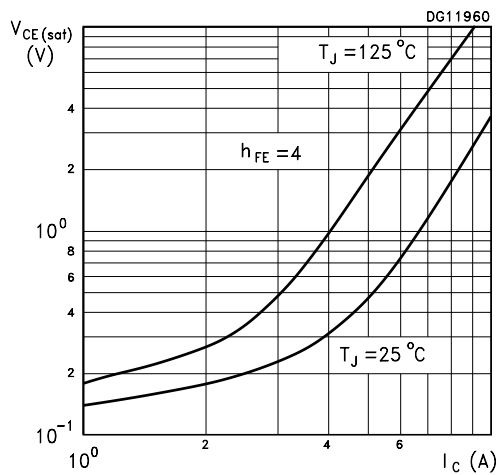

Base Emitter Saturation Voltage

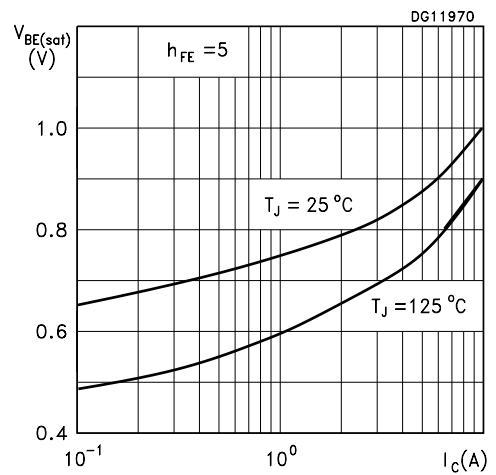

DC Current Gain

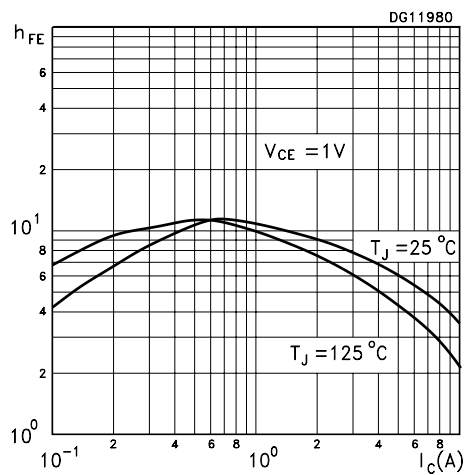

DC Current Gain

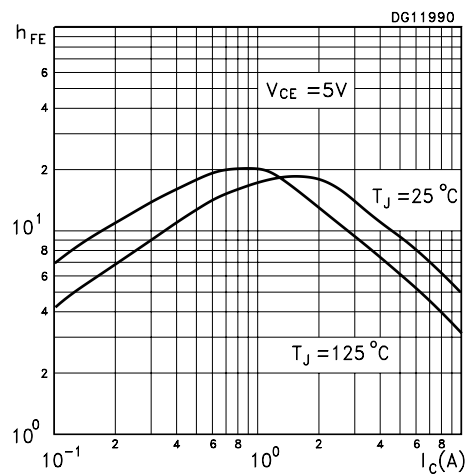

# ST2310DHI

## Power Losses

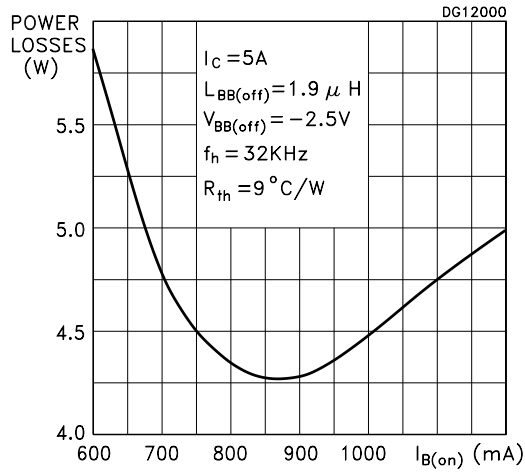

## Switching Time Inductive Load

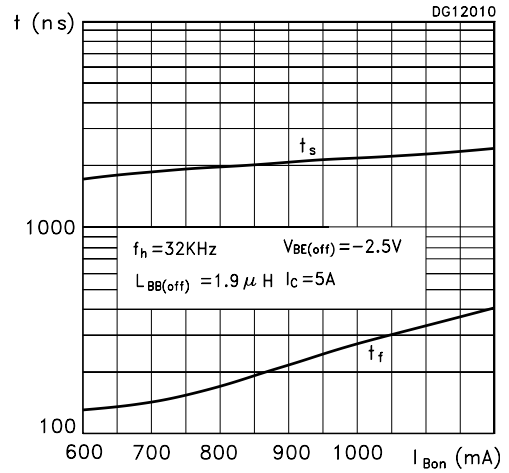

## Reverse Biased SOA

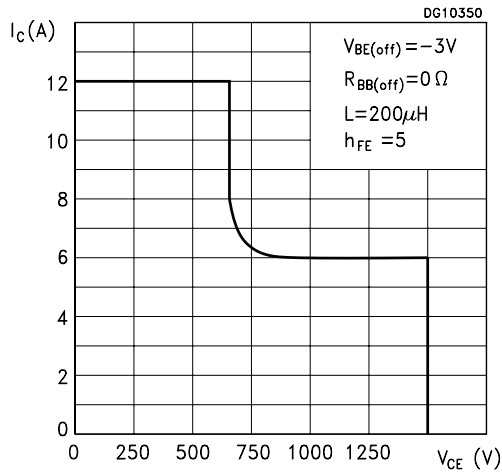
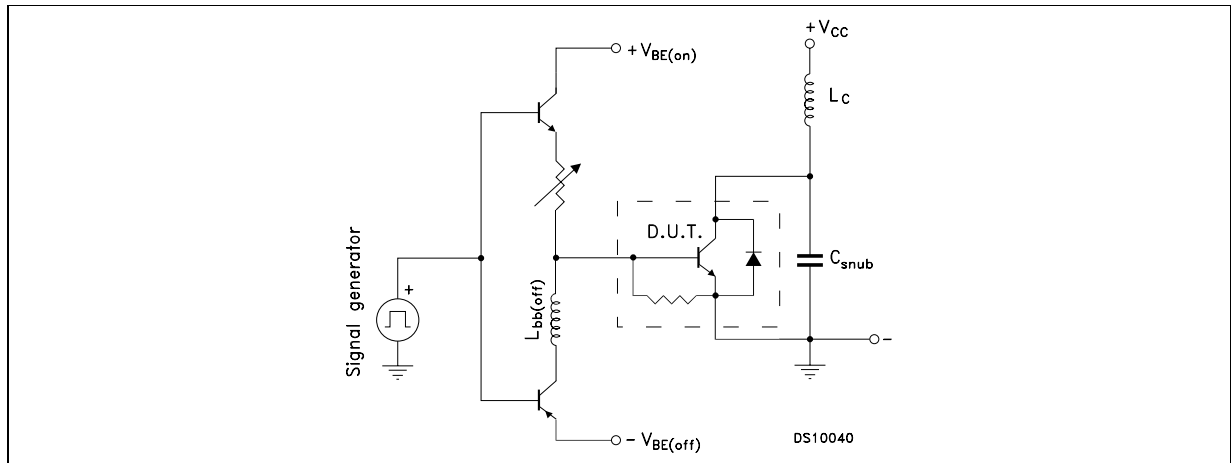
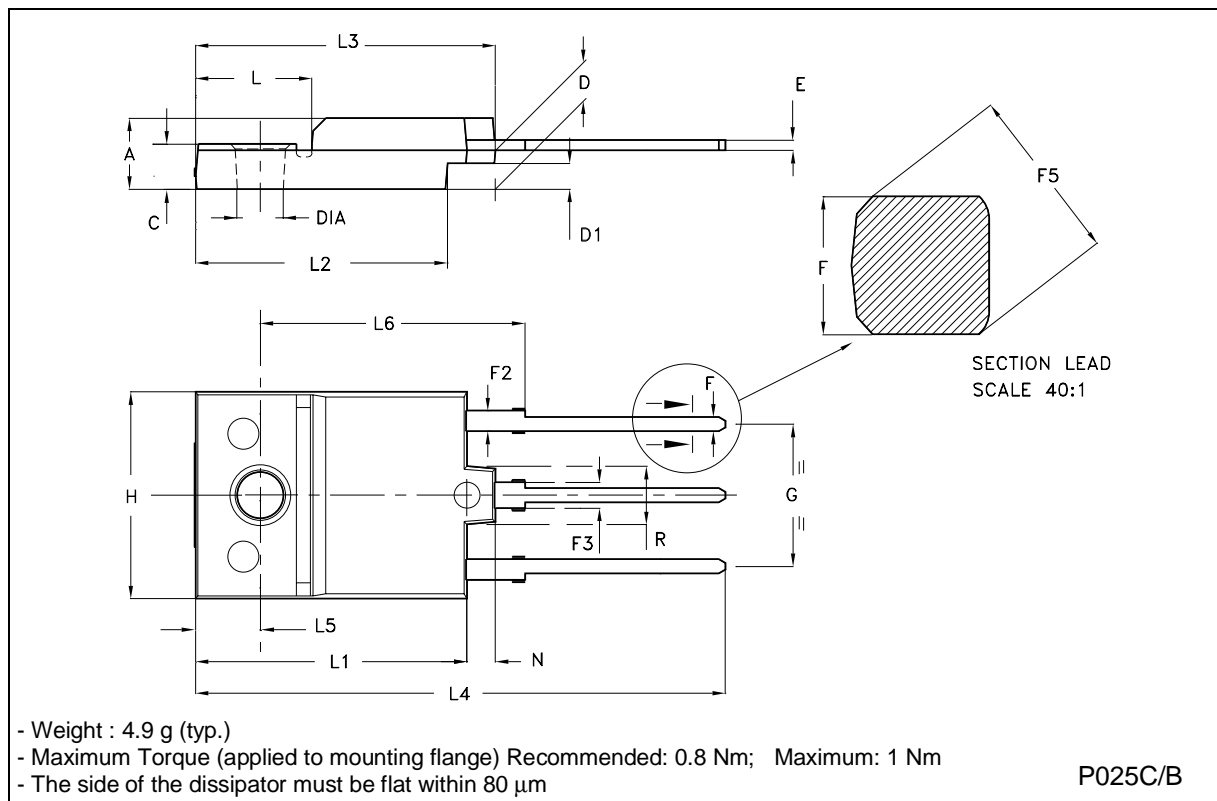

Figure 1: Inductive Load Switching Test Circuit.



**ISOWATT218 NARROW LEADS MECHANICAL DATA**

DIM.	mm			inch		
	MIN.	TYP.	MAX.	MIN.	TYP.	MAX.
A	5.35		5.65	0.211		0.222
C	3.30		3.80	0.130		0.150
D	2.90		3.10	0.114		0.122
D1	1.88		2.08	0.074		0.082
E	0.75		0.95	0.030		0.037
F	0.75		0.95	0.030		0.037
F2	1.50		1.70	0.059		0.067
F3	1.90		2.10	0.075		0.083
F5			1.10			0.043
G	10.80		11.20	0.425		0.441
H	15.80		16.20	0.622		0.638
L		9			0.354	
L1	20.80		21.20	0.819		0.835
L2	19.10		19.90	0.752		0.783
L3	22.80		23.60	0.898		0.929
L4	40.50		42.50	1.594		1.673
L5	4.85		5.25	0.191		0.207
L6	20.25		20.75	0.797		0.817
N	2.1		2.3	0.083		0.091
R		4.6			0.181	
DIA	3.5		3.7	0.138		0.146



## ST2310DHI

---

Information furnished is believed to be accurate and reliable. However, STMicroelectronics assumes no responsibility for the consequences of use of such information nor for any infringement of patents or other rights of third parties which may result from its use. No license is granted by implication or otherwise under any patent or patent rights of STMicroelectronics. Specification mentioned in this publication are subject to change without notice. This publication supersedes and replaces all information previously supplied. STMicroelectronics products are not authorized for use as critical components in life support devices or systems without express written approval of STMicroelectronics.

The ST logo is a trademark of STMicroelectronics

© 2003 STMicroelectronics – Printed in Italy – All Rights Reserved

STMicroelectronics GROUP OF COMPANIES

Australia - Brazil - Canada - China - Finland - France - Germany - Hong Kong - India - Israel - Italy - Japan - Malaysia - Malta - Morocco - Singapore - Spain - Sweden - Switzerland - United Kingdom - United States.

<http://www.st.com>