

Fuji Discrete Package IGBT

■ Features

- Square RBSOA
- Low Saturation Voltage
- Less Total Power Dissipation
- Minimized Internal Stray Inductance

■ Applications

- High Power Switching
- A.C. Motor Controls
- D.C. Motor Controls
- Uninterruptible Power Supply

■ Outline Drawing

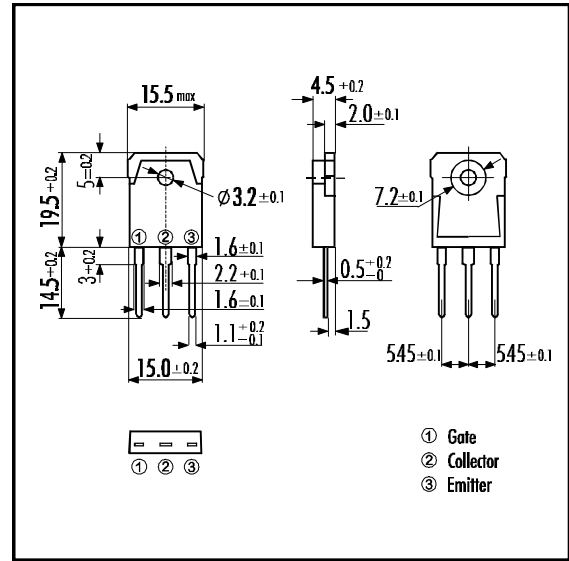

■ Maximum Ratings and Characteristics

• Absolute Maximum Ratings ($T_c=25^\circ\text{C}$)

Items	Symbols	Ratings	Units
Collector-Emitter Voltage	V_{CES}	1200	V
Gate -Emitter Voltage	V_{GES}	± 20	V
Collector Current	DC $T_c=25^\circ\text{C}$	I_{C25}	9
	DC $T_c=100^\circ\text{C}$	I_{C100}	5
	1ms $T_c=25^\circ\text{C}$	I_{CPULSE}	27
IGBT Max. Power Dissipation	P_C	100	W
FWD Max. Power Dissipation	P_C	60	W
Operating Temperature	T_j	+150	$^\circ\text{C}$
Storage Temperature	T_{stg}	-40 ~ +150	$^\circ\text{C}$
Mounting Screw Torque		50	Nm

■ Equivalent Circuit

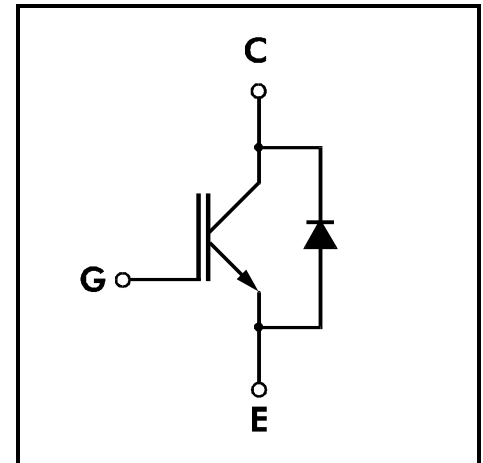

• Electrical Characteristics (at $T_j=25^\circ\text{C}$)

Items	Symbols	Test Conditions	Min.	Typ.	Max.	Units	
Zero Gate Voltage Collector Current	I_{CES}	$V_{GE}=0V$ $V_{CE}=1200V$			1.0	mA	
Gate-Emitter Leakage Current	I_{GES}	$V_{CE}=0V$ $V_{GE}=\pm 20V$			20	μA	
Gate-Emitter Threshold Voltage	$V_{GE(th)}$	$V_{GE}=20V$ $I_C=5\text{mA}$	5.5		8.5	V	
Collector-Emitter Saturation Voltage	$V_{CE(sat)}$	$V_{GE}=15V$ $I_C=5A$			3.5	V	
Input capacitance	C_{ies}	$V_{GE}=0V$		650		pF	
Output capacitance	C_{oes}	$V_{CE}=10V$		150			
Reverse Transfer capacitance	C_{res}	$f=1\text{MHz}$		40			
Switching Time	Turn-on Time	t_{ON}	$V_{CC}=600V$			1.2	μs
		t_r	$I_C=5A$			0.6	
	Turn-off Time	t_{OFF}	$V_{GE}=\pm 15V$			1.5	
		t_f	$R_G=330\Omega$			0.5	
	Turn-on Time	t_{ON}	$V_{CC}=600V$		0.16		μs
		t_r	$I_C=5A$		0.11		
		t_{OFF}	$V_{GE}=\pm 15V$		0.30		
		t_f	$R_G=33\Omega$			0.5	
Diode Forward On-Voltage	V_F	$I_F=5A$ $V_{GE}=0V$			3.0	V	
Reverse Recovery Time	t_{rr}	$I_F=5A$, $V_{GE}=-10V$, $di/dt=100A/\mu\text{s}$			350	ns	

• Thermal Characteristics

Items	Symbols	Test Conditions	Min.	Typ.	Max.	Units
Thermal Resistance	$R_{th(j-c)}$	IGBT			1.25	$^\circ\text{C/W}$
	$R_{th(j-e)}$	Diode			2.08	

Collector Current vs. Collector-Emittor Voltage

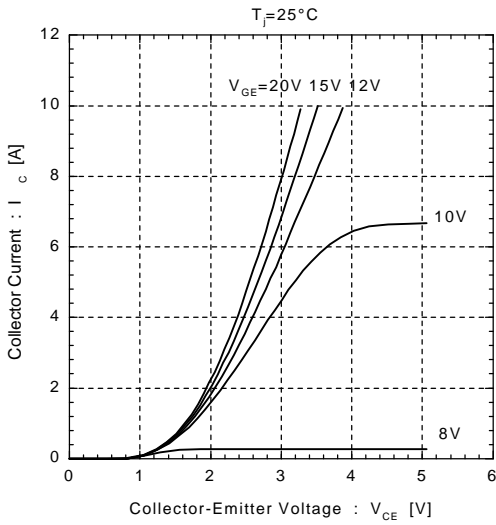

Collector Current vs. Collector-Emittor Voltage

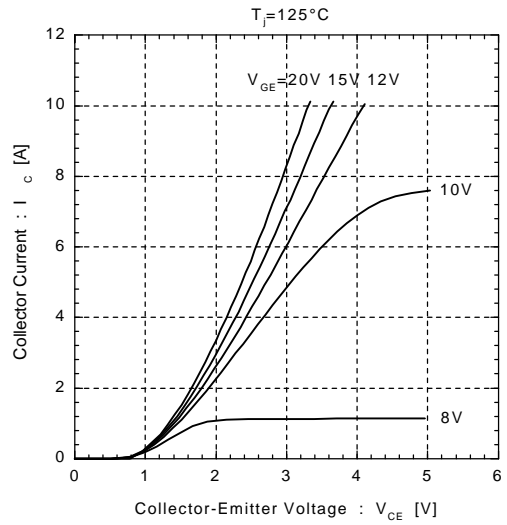

Collector-Emittor Voltage vs. Gate-Emittor Voltage

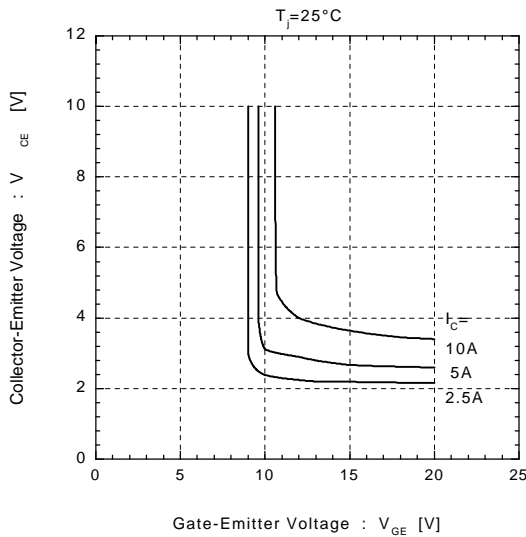

Collector-Emittor Voltage vs. Gate-Emittor Voltage

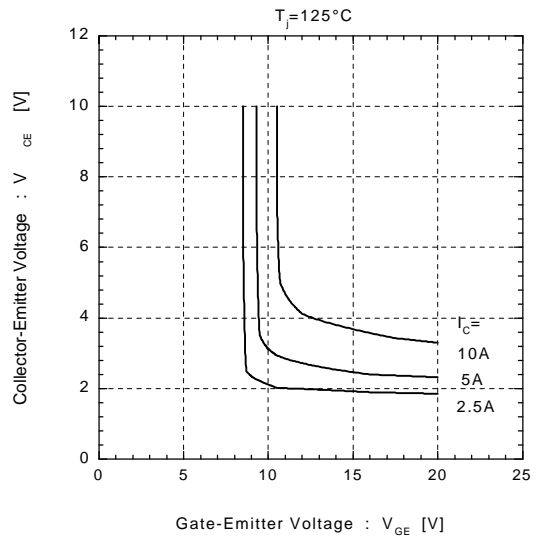

Switching Time vs. Collector Current
 $V_{CC} = 600V, R_G = 33\Omega, V_{GE} = \pm 15V, T_J = 25^\circ\text{C}$

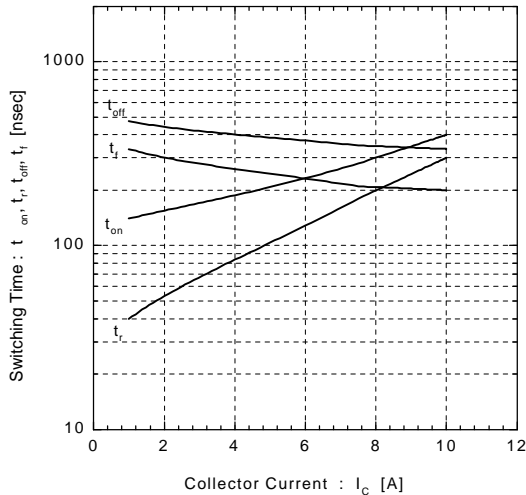

Switching Time vs. Collector Current
 $V_{CC} = 600V, R_G = 33\Omega, V_{GE} = \pm 15V, T_J = 125^\circ\text{C}$

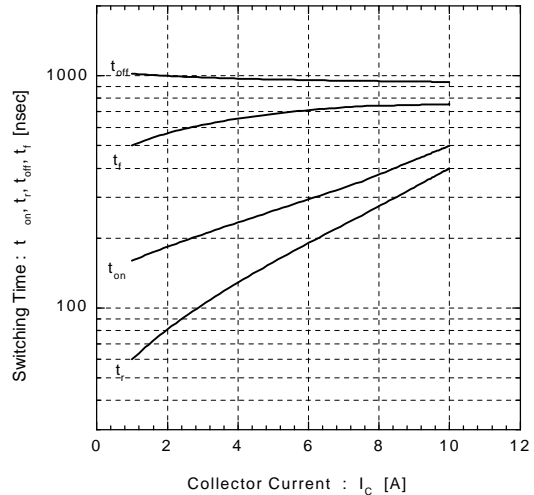

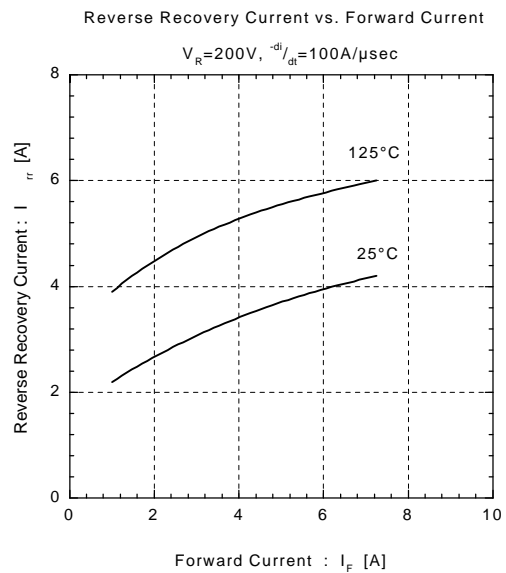
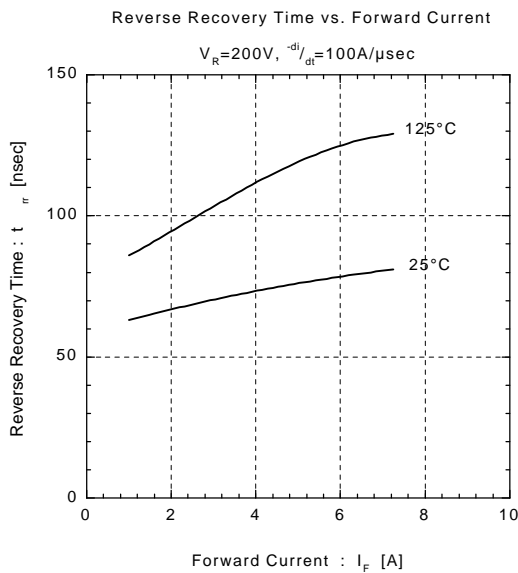
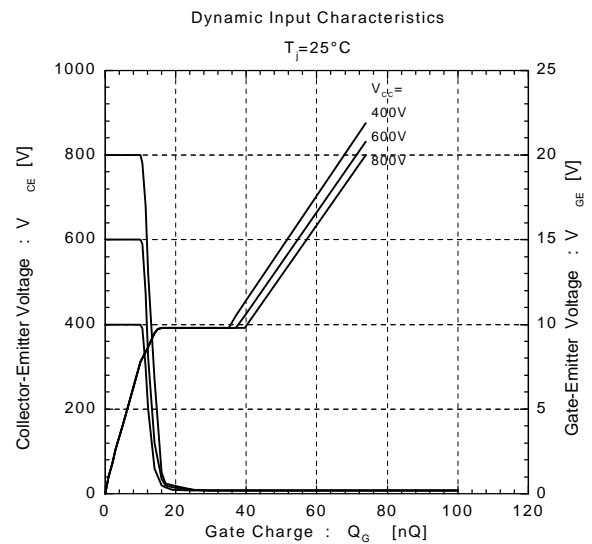
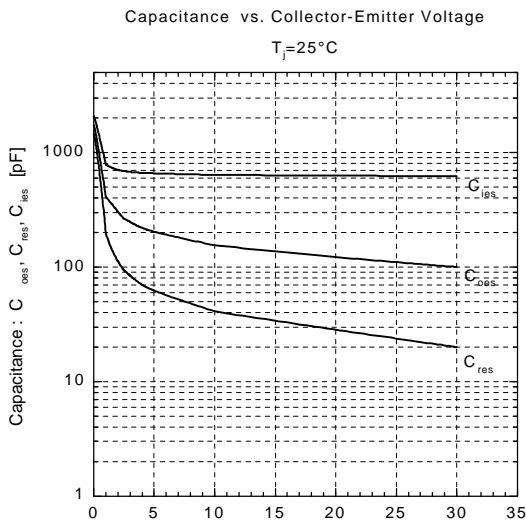
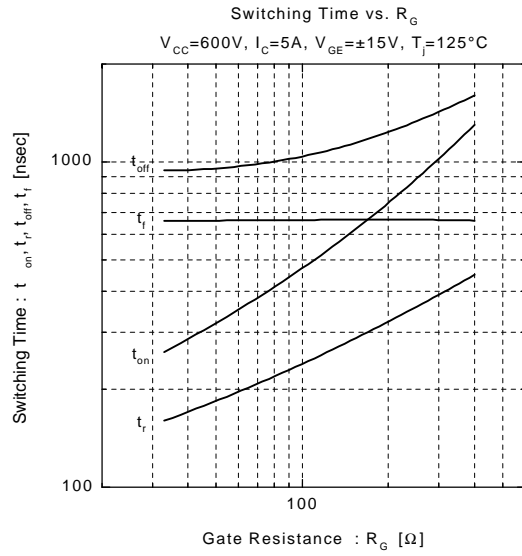
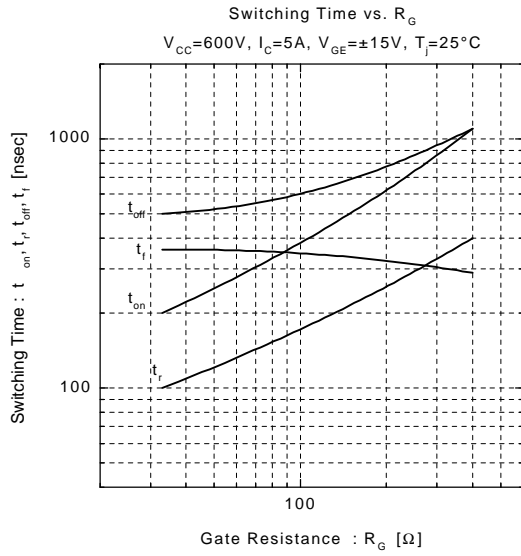

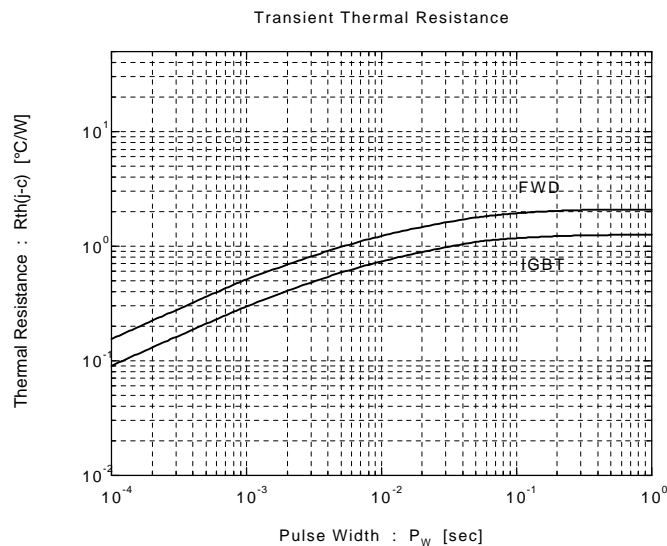
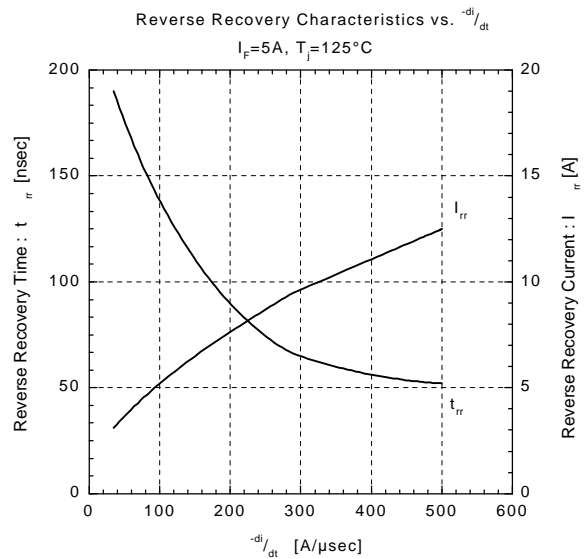
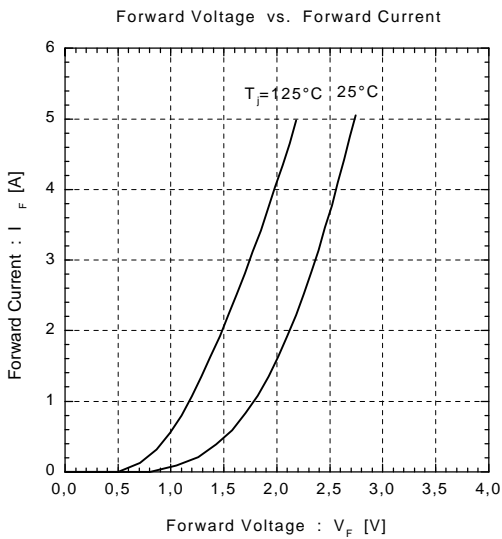
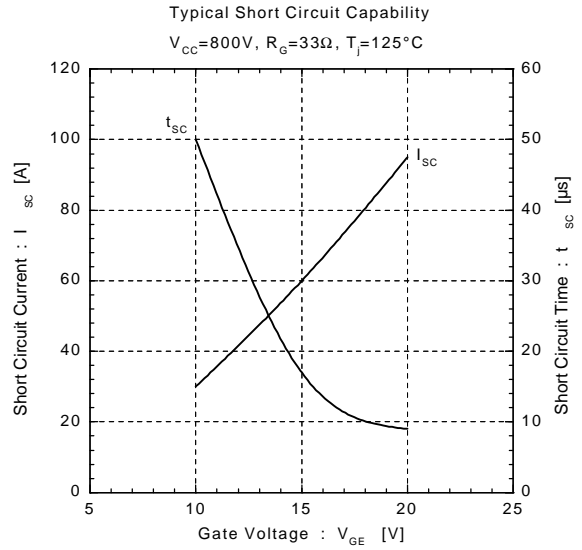
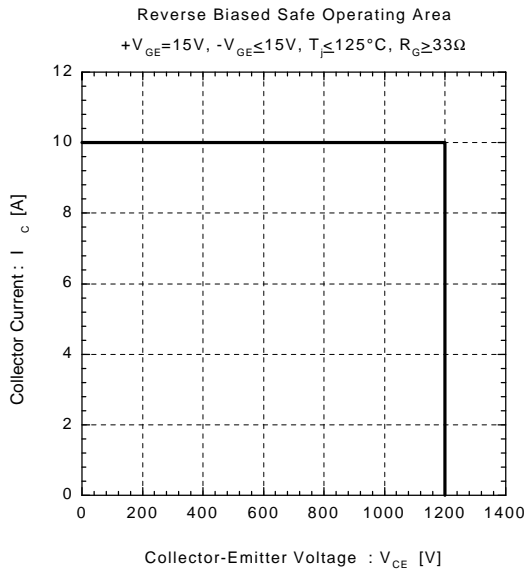

Switching losses (E_{on} , E_{off} vs. I_c)

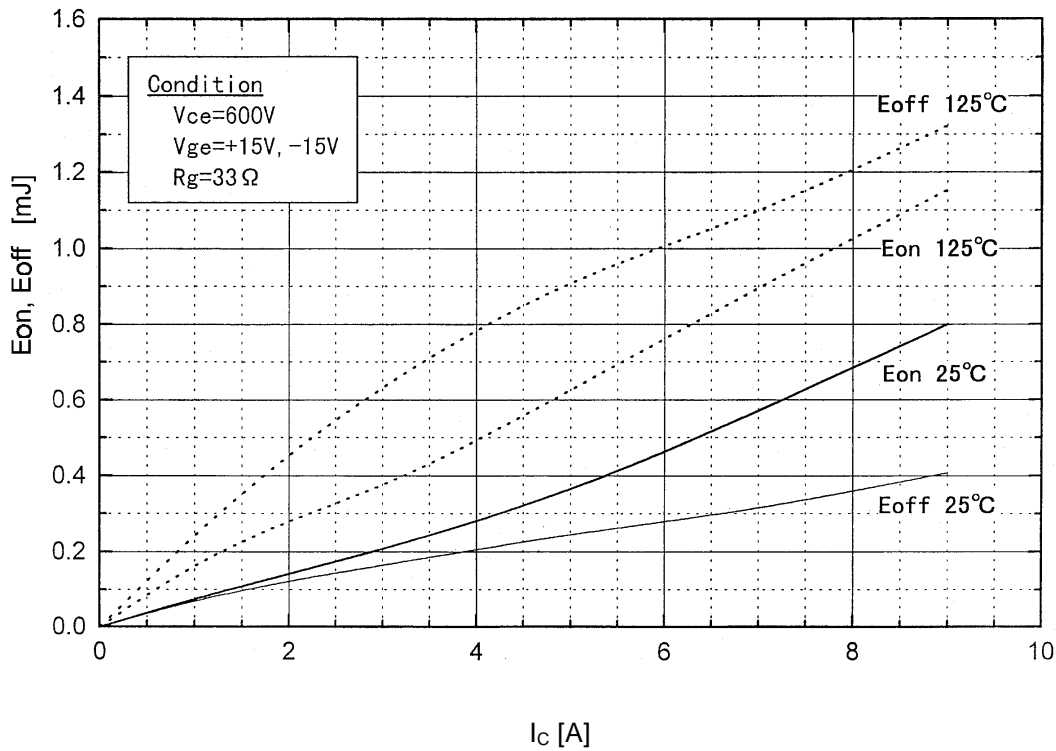

Test Circuit

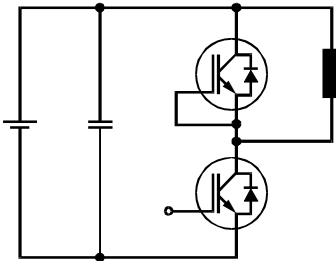

Switching waveforms

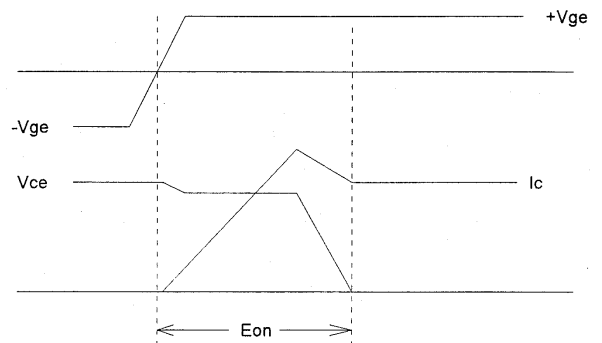

Turn-on Waveforms

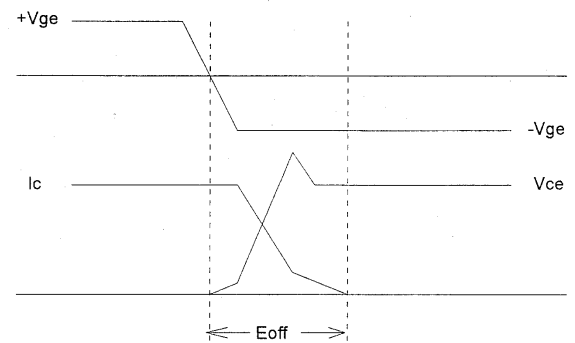

Turn-off Waveforms