

Cree® PLCC4 3 in 1 SMD LED

CLV1A-FKB

Data Sheet

Cree PLCC full-color LEDs offer high-intensity light output and a wide viewing angle in an industry-standard package. Designed to work in a wide array of environmental conditions, Cree PLCC full-color LEDs are suited for indoor video screen, decorative lighting and amusement applications.

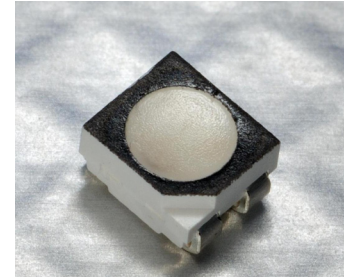

FEATURES

- Size (mm): 3.2 x 2.8
- Dominant Wavelength (nm):
Red (619-624)
Green (520-540)
Blue (460-480)
- Luminous Intensity (mcd)
Red (355-900)
Green (560-1400)
Blue (180-450)
- Lead-Free
- Viewing Angle: 120 degree
- RoHS Compliant

APPLICATIONS

- Full-Color Video Screen
- Decorative lighting
- Amusement

Absolute Maximum Ratings ($T_A = 25^\circ\text{C}$)

Items	Symbol	Absolute Maximum Rating			Unit
		R	G	B	
Forward Current ^{Note 1}	I_F	50	25	25	mA
Peak Forward Current ^{Note 2}	I_{FP}	200	100	100	mA
Reverse Voltage	V_R	5	5	5	V
Power Dissipation	P_D	130	100	100	mW
Operation Temperature	T_{opr}	-40 ~ +100			$^\circ\text{C}$
Storage Temperature	T_{stg}	-40 ~ +100			$^\circ\text{C}$
Junction Temperature	T_J	110	110	110	$^\circ\text{C}$
Junction/ambient 1 chip on	R_{THJA}	450	400	450	$^\circ\text{C}/\text{W}$
Junction/ambient 3 chips on	R_{THJA}	650	580	680	$^\circ\text{C}/\text{W}$
Junction/solder point 1 chip on	R_{THJS}	300	280	300	$^\circ\text{C}/\text{W}$
Junction/solder point 3 chips on	R_{THJS}	450	430	480	$^\circ\text{C}/\text{W}$

Note:

1. Single-color light.
2. Pulse width ≤ 0.1 msec, duty $\leq 1/10$.

Typical Electrical & Optical Characteristics ($T_A = 25^\circ\text{C}$)

Characteristics	Condition	Symbol	Values			Unit
			R	G	B	
Wavelength at peak emission	$I_F = 20$ mA	λ_{PEAK}	630	527	470	nm
Dominant Wavelength	$I_F = 20$ mA	λ_{DOM}	619~624	520~540	460~480	nm
Spectral bandwidth at 50% I_{REL} max	$I_F = 20$ mA	$\Delta \lambda$	24	38	28	nm
Viewing Angle at 50% I_V	$I_F = 20$ mA	$2\theta_{1/2}$	120	120	120	deg
Forward Voltage	$I_F = 20$ mA	$V_{F(avg)}$	2.0	3.2	3.2	V
		$V_{F(max)}$	2.6	4.0	4.0	V
Luminous Intensity	$I_F = 20$ mA	$I_{V(min)}$	355	560	180	mcd
		$I_{V(avg)}$	550	850	320	mcd
Reverse Current (max)	$V_R = 5$ V	I_R	10	10	10	μA



Intensity Bin Limit ($I_F = 20 \text{ mA}$)

Red

Bin Code	Min.(mcd)	Max.(mcd)
H	355	450
J	450	560
K	560	710
M	710	900

Green

Bin Code	Min.(mcd)	Max.(mcd)
K	560	710
M	710	900
N	900	1120
P	1120	1400

Blue

Bin Code	Min.(mcd)	Max.(mcd)
E	180	224
F	224	280
G	280	355
H	355	450
j	450	505

Tolerance of measurement of luminous intensity is $\pm 10\%$

Color Bin Limit ($I_F = 20 \text{ mA}$)

Red

Bin Code	Min.(nm)	Max.(nm)
RB	619	624

Green

Bin Code	Min.(nm)	Max.(nm)
G7	520	525
G8	525	530
G9	530	535
Ga	535	540

Blue

Bin Code	Min.(nm)	Max.(nm)
B3	460	465
B4	465	470
B5	470	475
B6	475	480

Tolerance of measurement of dominant wavelength is $\pm 1 \text{ nm}$



Order Code Table*

Kit Number	Color	Luminous Intensity (mcd)		Dominant Wavelength (nm)				Package
		Min.	Max.	Color Bin	Min. (nm)	Color Bin	Max. (nm)	
CLV1A-FKB-CHMKPEHBB7a363	Red	355	900	RB	619	RB	624	Reel
	Green	560	1400	G7	520	Ga	540	Reel
	Blue	180	450	B3	460	B6	480	Reel
CLV1A-FKB-CHMKPEHBB7a463	Red	355	900	RB	619	RB	624	Reel
	Green	560	1400	G7	520	Ga	540	Reel
	Blue	180	450	B4	465	B6	480	Reel
CLV1A-FKB-CH1K1E1BB7R3S3	Red	Any 1 Intensity bin from H(355) - K(710)		RB	619	RB	624	Reel
	Green	Any 1 Intensity bin from K(560) - N(1120)		Any 1 hue bin from G7(520) - Ga(540)				Reel
	Blue	Any 1 Intensity bin from E(180) - G(355)		Any 1 hue bin from B3(460) - B5(475)				Reel
CLV1A-FKB-CH1K1E1BB7R4S3	Red	Any 1 Intensity bin from H(355) - K(710)		RB	619	RB	624	Reel
	Green	Any 1 Intensity bin from K(560) - N(1120)		Any 1 hue bin from G7(520) - Ga(540)				Reel
	Blue	Any 1 Intensity bin from E(180) - G(355)		Any 1 hue bin from B4(465) - B6(480)				Reel
CLV1A-FKB-CJ1M1F1BB7R3S3	Red	Any 1 Intensity bin from J(450) - M(900)		RB	619	RB	624	Reel
	Green	Any 1 Intensity bin from M(710) - P(1400)		Any 1 hue bin from G7(520) - Ga(540)				Reel
	Blue	Any 1 Intensity bin from F(224) - H(450)		Any 1 hue bin from B3(460) - B5(475)				Reel
CLV1A-FKB-CJ1M1F1BB7R4S3	Red	Any 1 Intensity bin from J(450) - M(900)		RB	619	RB	624	Reel
	Green	Any 1 Intensity bin from M(710) - P(1400)		Any 1 hue bin from G7(520) - Ga(540)				Reel
	Blue	Any 1 Intensity bin from F(224) - H(450)		Any 1 hue bin from B4(465) - B6(480)				Reel
CLV1A-FKB-CK1N1G1BB7R4S3	Red	Any 1 Intensity bin from K(560) - M(900)		RB	619	RB	624	Reel
	Green	Any 1 Intensity bin from N(900) - P(1400)		Any 1 hue bin from G7(520) - Ga(540)				Reel
	Blue	Any 1 Intensity bin from G(280) - H(450)		Any 1 hue bin from B4(465) - B6(480)				Reel

Notes:

1. The above kit numbers represent the order codes which include multiple intensity-bin and color-bin codes. Only one intensity-bin code and one color-bin code will be shipped on each reel. Single intensity-bin code and single color-bin code will be orderable in certain quantities. For example, any 1 intensity bin from H - K means only 1 intensity bin (H or J or K) will be shipped by Cree. For example, any 1 color bin from G7 - Ga means only 1 color bin (G7 or G8 or G9 or Ga) will be shipped by Cree.
2. Please refer to the "Cree LED Lamp Reliability Test Standards" document for reliability test conditions.
3. Please refer to the "Cree LED Lamp Soldering & Handling" document for information about how to use this LED product safely.

Graphs

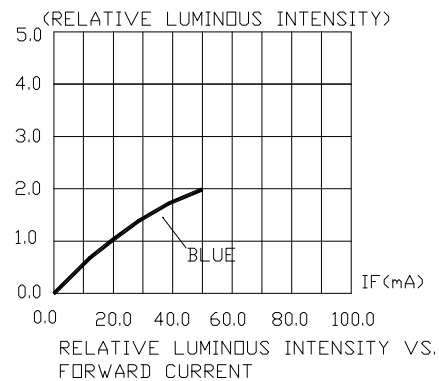
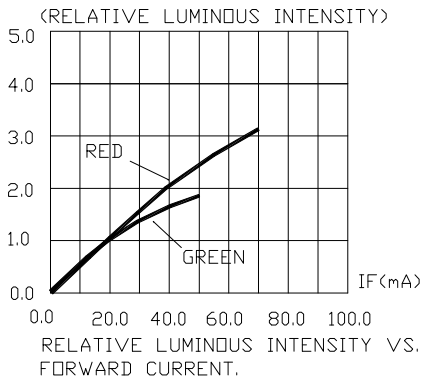
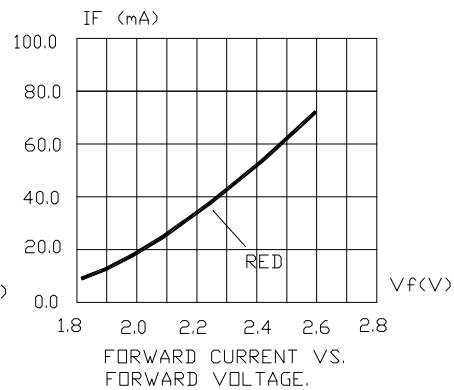
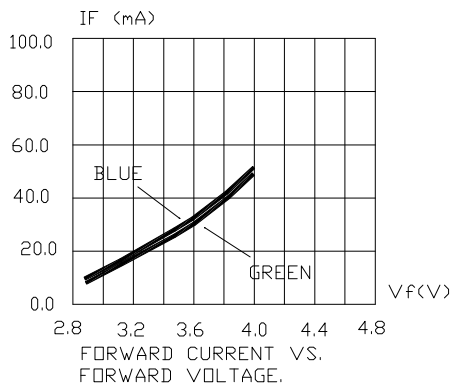
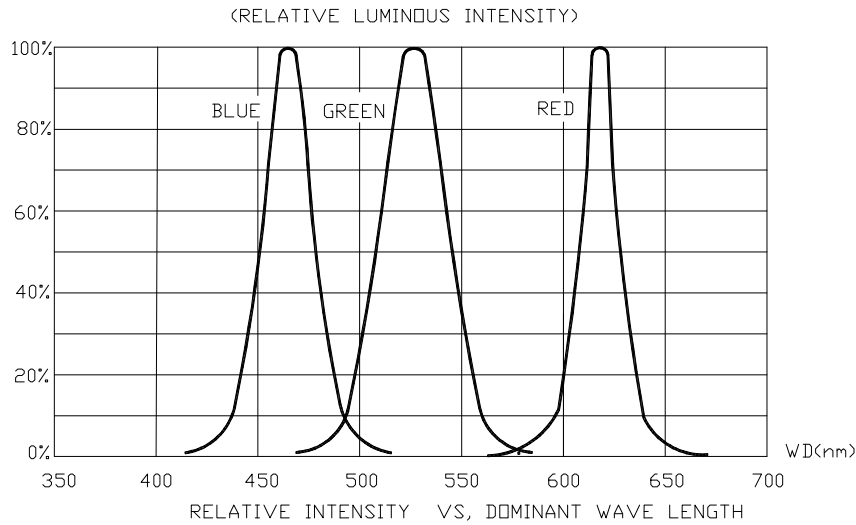

The above data are collected from statistical figures which do not necessarily correspond to the actual parameters of each single LED. Hence, these data will be changed without further notice.

Graphs

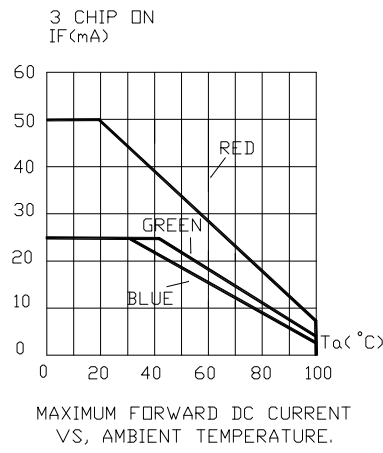
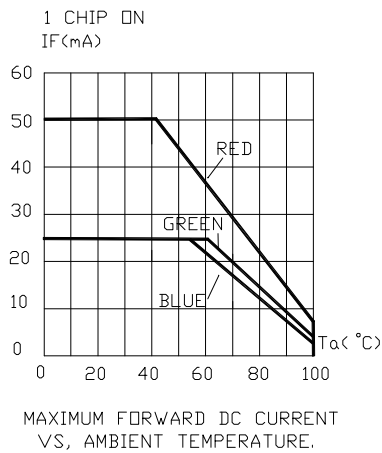
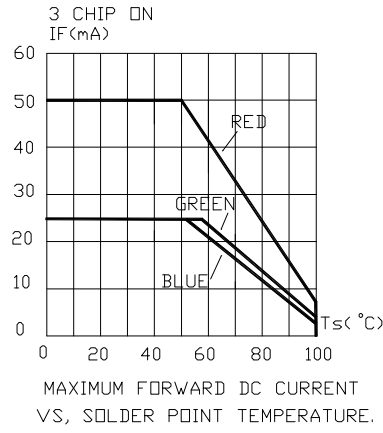
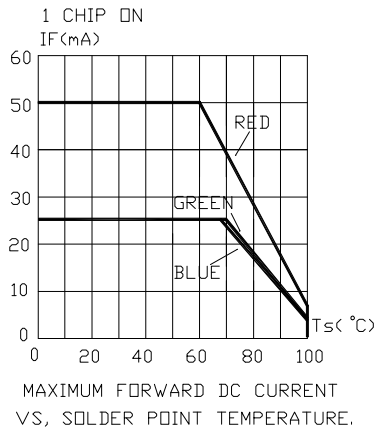
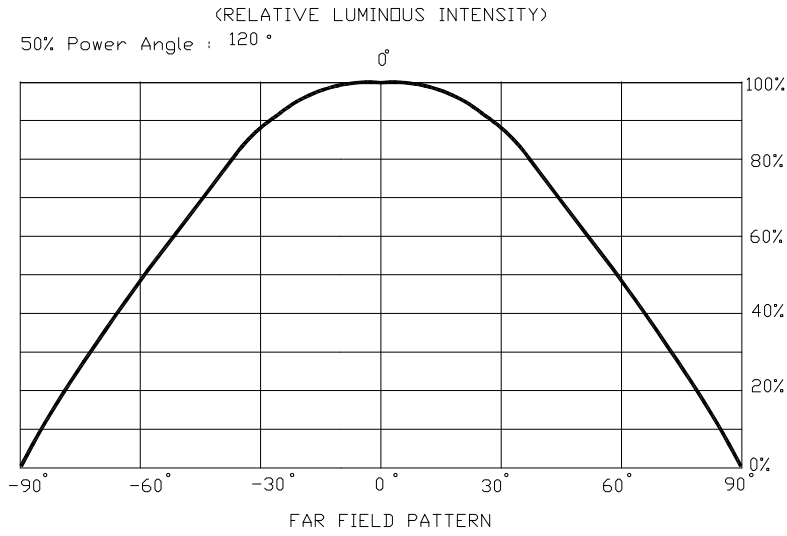

The above data are collected from statistical figures which do not necessarily correspond to the actual parameters of each single LED. Hence, these data will be changed without further notice.

Mechanical Dimensions

All dimensions are in mm.

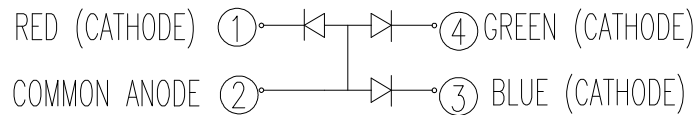
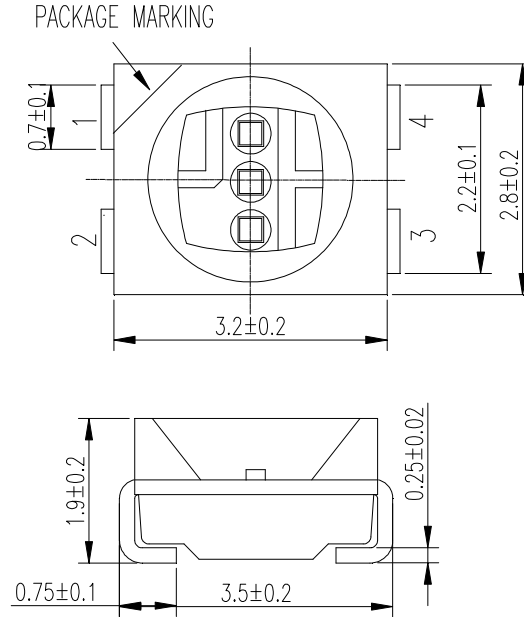

Notes

RoHS Compliance

The levels of environmentally sensitive, persistent biologically toxic (PBT), persistent organic pollutants (POP), or otherwise restricted materials in this product are below the maximum concentration values (also referred to as the threshold limits) permitted for such substances, or are used in an exempted application, in accordance with EU Directive 2002/95/EC on the restriction of the use of certain hazardous substances in electrical and electronic equipment (RoHS), as amended through April 21, 2006.

Vision Advisory Claim

Users should be cautioned not to stare at the light of this LED product. The bright light can damage the eye.



Kit Number System

Cree LED lamps are tested and sorted into performance bins. A bin is specified by ranges of color, forward voltage, and brightness. Sorted LEDs are packaged for shipping in various convenient options. Please refer to the "Cree LED Lamp Packaging Standard" document for more information about shipping and packaging options.

Cree LEDs are sold by order codes in combinations of bins called kits. Order codes are configured in the following manner:

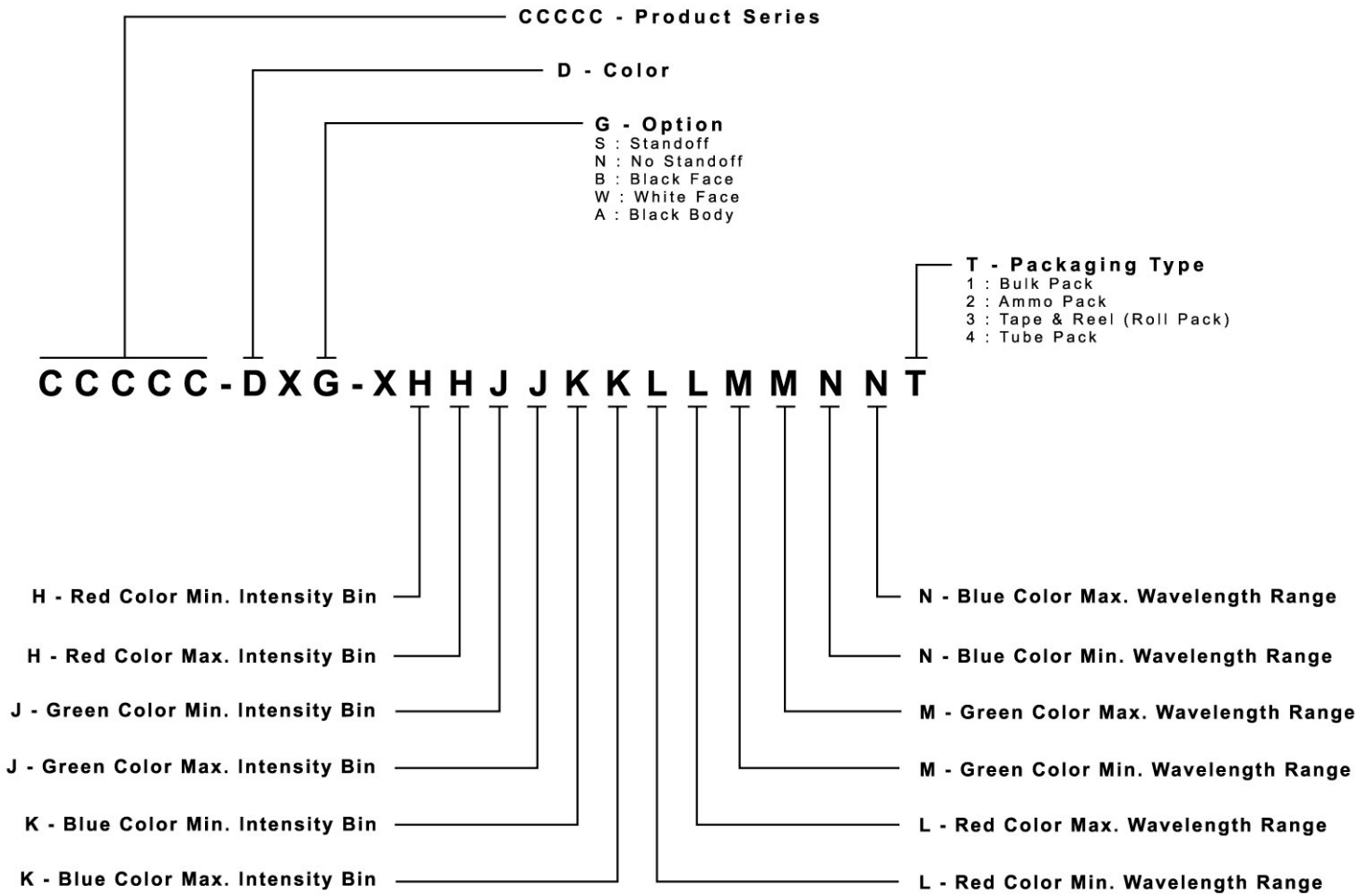

Package

- The boxes are not water resistant and they must be kept away from water and moisture.
- The LEDs are packed in cardboard boxes after packaging in normal or anti-electrostatic bags.
- Cardboard boxes will be used to protect the LEDs from mechanical shocks during transportation.
- The reel pack is applied in SMD LED.
- Max 2000 pcs per reel.

