

TOSHIBA HIGH EFFICIENCY DIODE STACK (HED) SILICON EPITAXIAL TYPE

10DL2CZ47A, 10FL2CZ47A, 10GL2CZ47A

SWITCHING MODE POWER SUPPLY APPLICATIONS
CONVERTER & CHOPPER APPLICATION

- Repetitive Peak Reverse Voltage : $V_{RRM}=200, 300, 400V$
- Average Output Rectified Current : $I_O=10A$
- Ultra Fast Reverse-Recovery Time : $t_{rr}=35ns$ (Max.)
- Low Switching Losses and Output Noise.

MAXIMUM RATINGS ($T_a = 25^\circ C$)

CHARACTERISTIC		SYMBOL	RATING	UNIT
Repetitive Peak Reverse Voltage	10DL2CZ47A	V_{RRM}	200	V
	10FL2CZ47A		300	
	10GL2CZ47A		400	
Average Output Rectified Current		I_O	10	A
Peak One Cycle Surge Forward Current (Sine Wave)		I_{FSM}	50 (50Hz)	A
			55 (60Hz)	
Junction Temperature		T_j	-40~150	$^\circ C$
Storage Temperature Range		T_{stg}	-40~150	$^\circ C$
Screw Torque		—	0.6	N·m

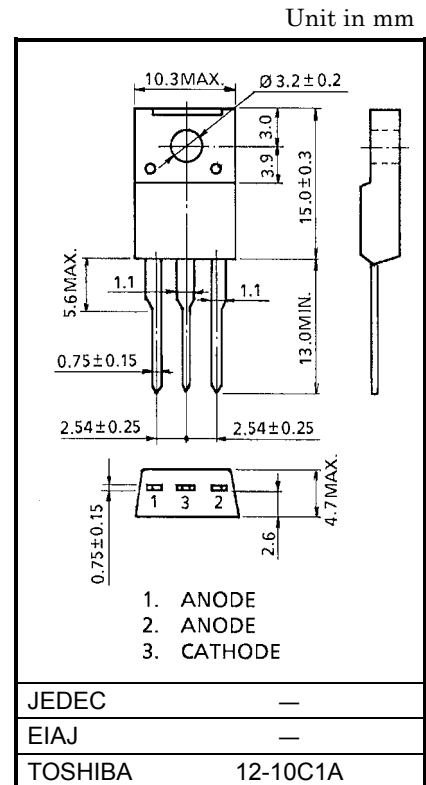

Weight : 2.0g

ELECTRICAL CHARACTERISTICS ($T_a = 25^\circ C$)

CHARACTERISTIC		SYMBOL	TEST CONDITION	MIN.	TYP.	MAX.	UNIT
Peak Forward Voltage (Note 1)	10DL2CZ47A	V_{FM}	$I_{FM}=5A$	—	—	0.98	V
	10FL2CZ47A			—	—	1.3	
	10GL2CZ47A			—	—	1.8	
Repetitive Peak Reverse Current (Note 1)	10DL2CZ47A	I_{RRM}	$V_{RRM}=\text{Rated}$	—	—	10	μA
	10FL2CZ47A			—	—	10	
	10GL2CZ47A			—	—	50	
Reverse Recovery Time (Note 1)		t_{rr}	$I_F=2A, di/dt=-20A/\mu s$	—	—	—	ns
Forward Recovery Time (Note 1)		t_{fr}	$I_F=1A$	—	—	—	ns
Thermal Resistance		$R_{th(j-c)}$	DC Total, Junction to Case	—	—	—	$^\circ C/W$

Note 1 : A value of one cell.

POLARITY

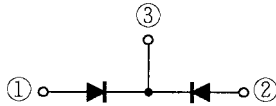

MARKING

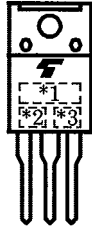

* 1	MARK	10DL2CZ	TYPE	10DL2CZ47A
		10FL2CZ		10FL2CZ47A
		10GL2CZ		10GL2CZ47A
* 2	A			
* 3	Lot Number □□ – Month (Starting from Alphabet A) └─── Year (Last Number of the Christian Era)			

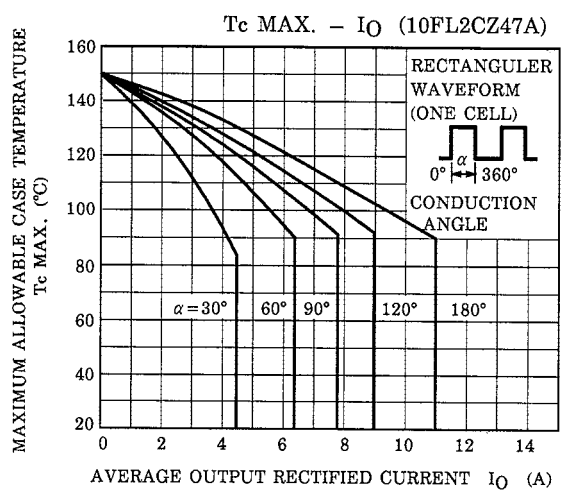
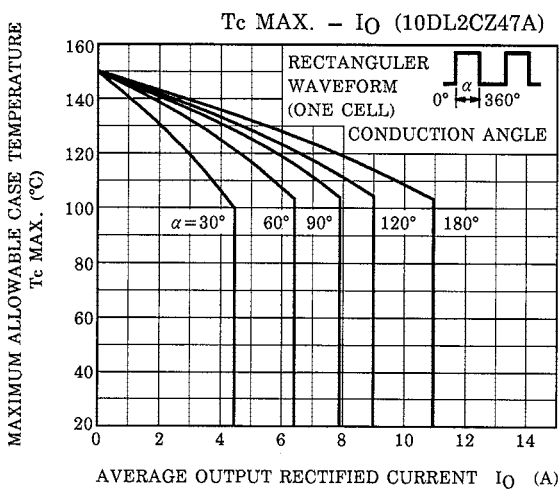
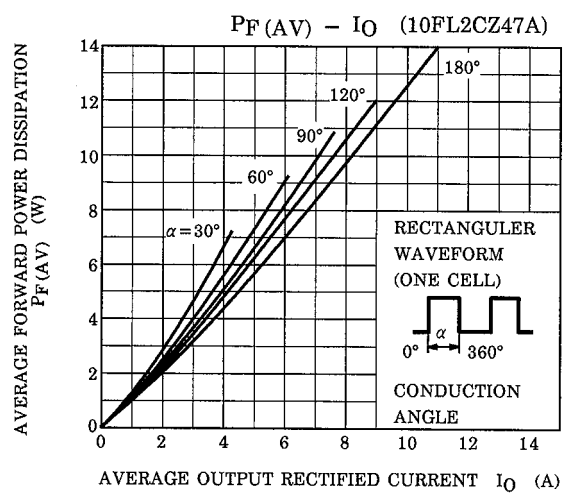
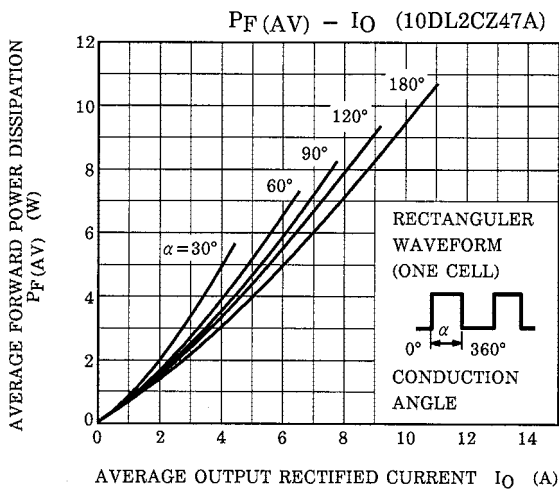
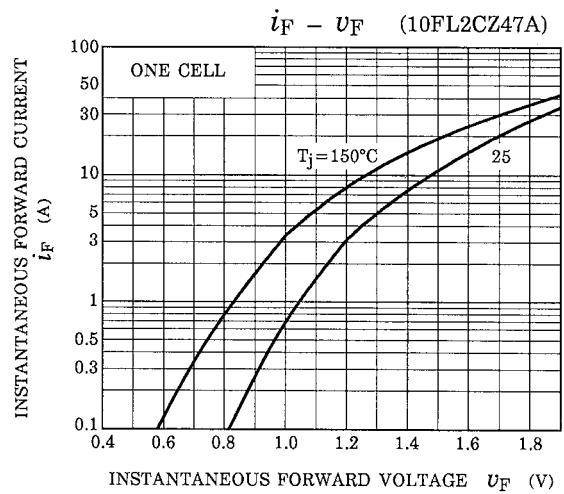
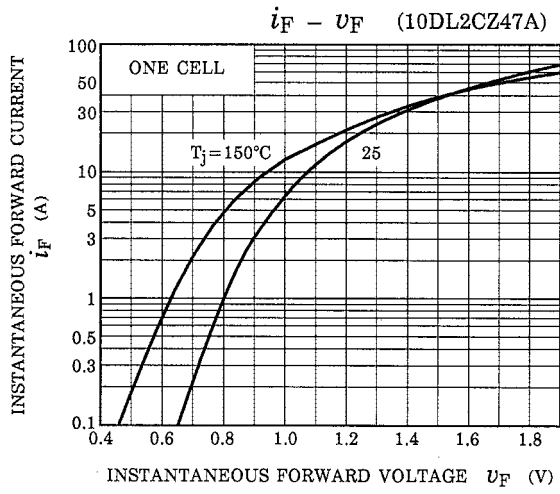

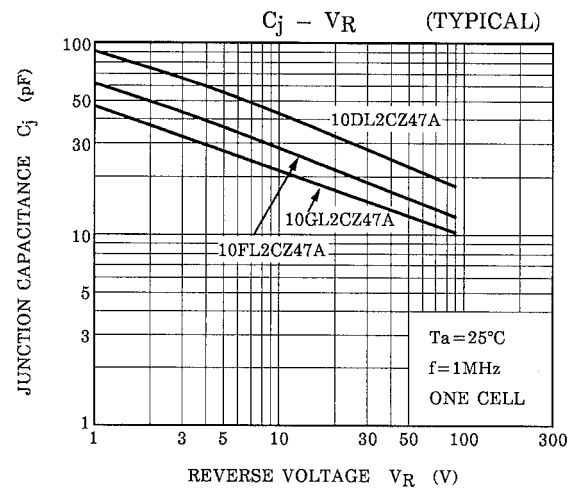
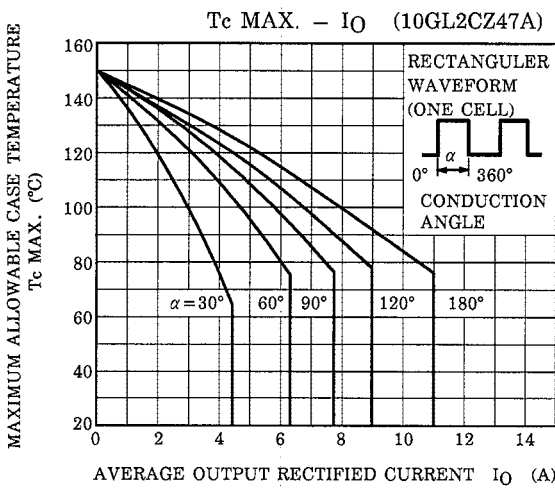
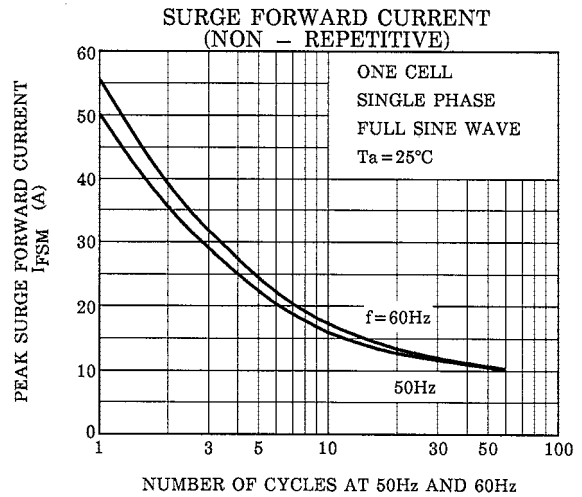
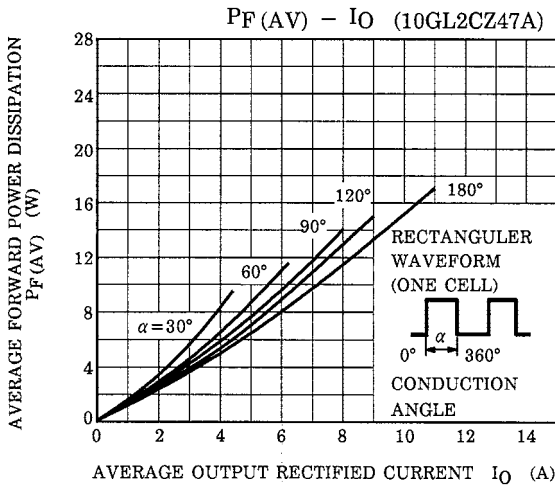
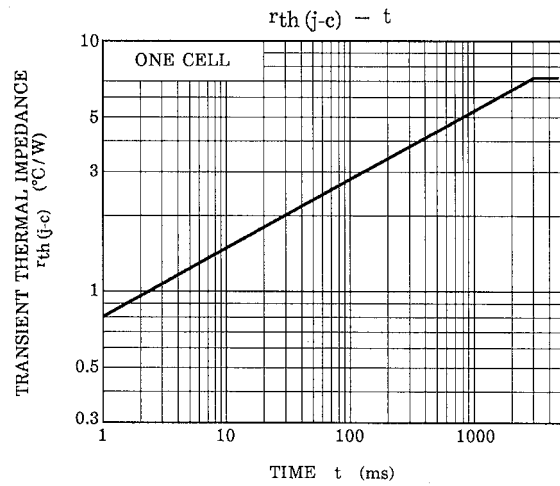
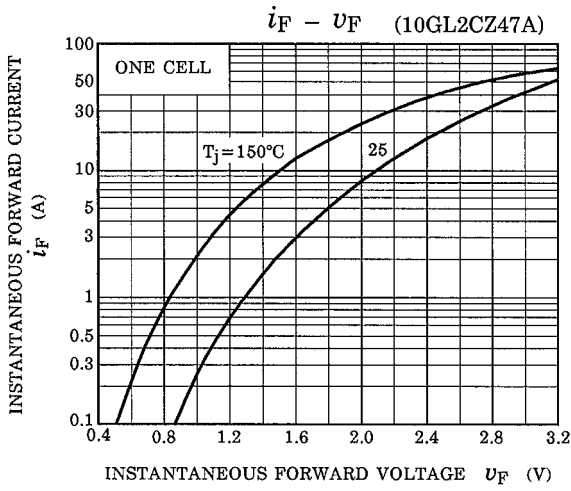

RESTRICTIONS ON PRODUCT USE

000707EAA

- TOSHIBA is continually working to improve the quality and reliability of its products. Nevertheless, semiconductor devices in general can malfunction or fail due to their inherent electrical sensitivity and vulnerability to physical stress. It is the responsibility of the buyer, when utilizing TOSHIBA products, to comply with the standards of safety in making a safe design for the entire system, and to avoid situations in which a malfunction or failure of such TOSHIBA products could cause loss of human life, bodily injury or damage to property.
In developing your designs, please ensure that TOSHIBA products are used within specified operating ranges as set forth in the most recent TOSHIBA products specifications. Also, please keep in mind the precautions and conditions set forth in the "Handling Guide for Semiconductor Devices," or "TOSHIBA Semiconductor Reliability Handbook" etc..
- The TOSHIBA products listed in this document are intended for usage in general electronics applications (computer, personal equipment, office equipment, measuring equipment, industrial robotics, domestic appliances, etc.). These TOSHIBA products are neither intended nor warranted for usage in equipment that requires extraordinarily high quality and/or reliability or a malfunction or failure of which may cause loss of human life or bodily injury ("Unintended Usage"). Unintended Usage include atomic energy control instruments, airplane or spaceship instruments, transportation instruments, traffic signal instruments, combustion control instruments, medical instruments, all types of safety devices, etc.. Unintended Usage of TOSHIBA products listed in this document shall be made at the customer's own risk.
- The information contained herein is presented only as a guide for the applications of our products. No responsibility is assumed by TOSHIBA CORPORATION for any infringements of intellectual property or other rights of the third parties which may result from its use. No license is granted by implication or otherwise under any intellectual property or other rights of TOSHIBA CORPORATION or others.
- The information contained herein is subject to change without notice.